



KV XtremeTM

Skatepark

INSTRUCTIONS

Requires 3 'AA' batteries (not included).

For best performance, use alkaline batteries.

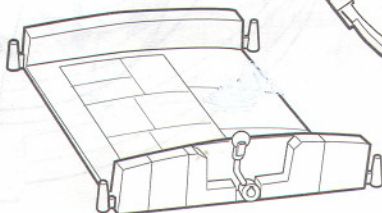
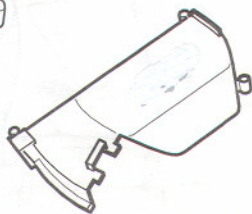
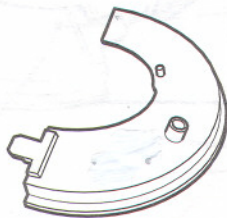
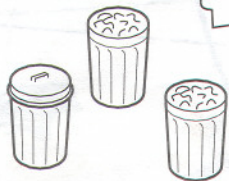
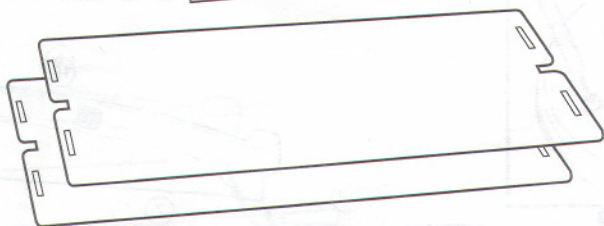
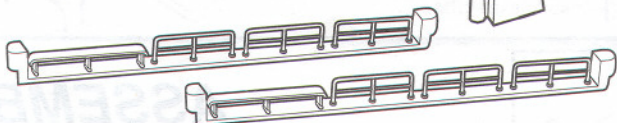
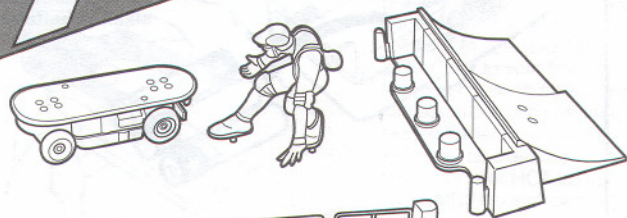

25668-0920 M1

⚠ WARNING:

CHOKING HAZARD - Small parts.
Not for children under 3 years.



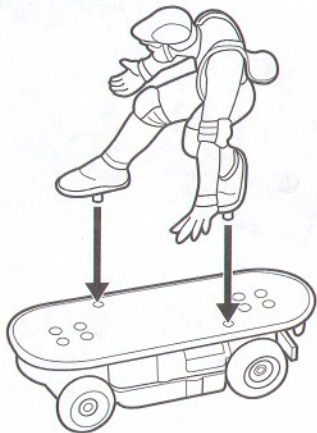

Align pegs on bottom of skateboarder's hands/feet with holes on skateboard. Snap into place.

INSTALL BATTERIES:

Using screwdriver (not included), remove center screw to open battery door as shown. Insert 3 "AA" batteries (not included). Be sure to insert batteries as indicated. Replace and refasten battery door. If car does not fully charge in 10 seconds, replace batteries.

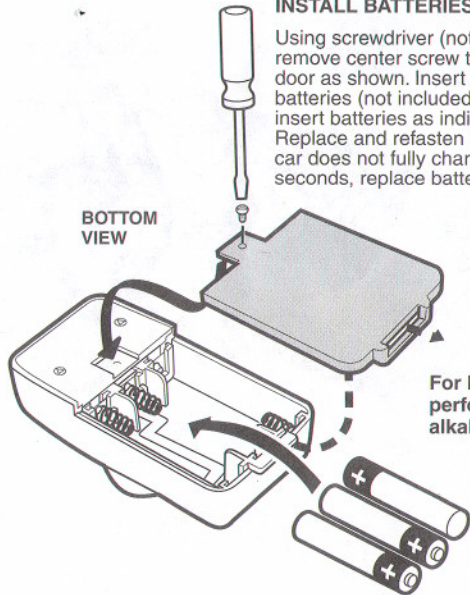

BOTTOM VIEW

For best performance, use alkaline batteries.

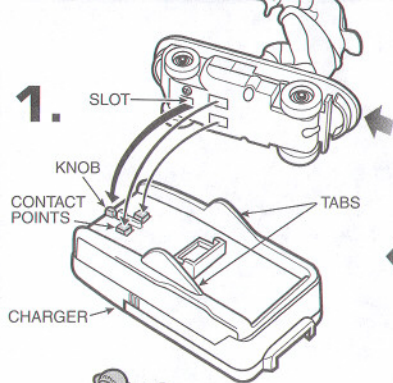

Push top of skateboarder forward to engage forward switch. Line up slot on bottom of skateboarder with knob as shown. Contact points on bottom of skateboarder must line up with contact points on charger.

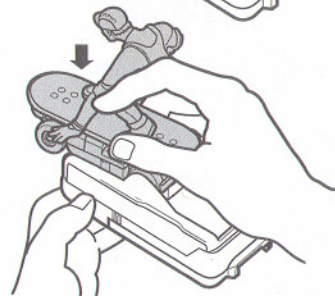
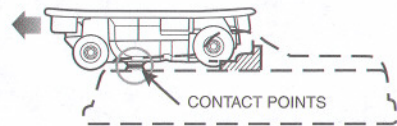

Hold charger with one hand and then press down on top of skateboarder as shown, with the other. Rear wheels will start to spin. **DO NOT** hold wheels, allow them to spin freely. Press down for 10 seconds to fully charge skateboarder. (Do not charge skateboarder for more than 10 seconds, as overcharging may reduce the life of your HOT WHEELS® X-V XTREME™ skateboarder.)

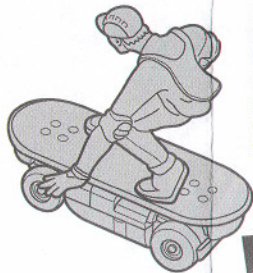

Place skateboarder on hard, smooth surface or HOT WHEELS track and release. (Skateboarder will run for approximately 30 seconds each time it is fully charged). Do not run skateboarder on shag carpet, dirt or wet surfaces.

Skateboard will reverse direction when it strikes an object.

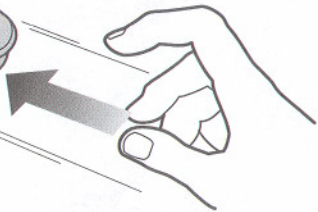

- **VEHICLE CONTAINS A RECHARGEABLE CELL. IF FLUID LEAKS, AVOID CONTACT WITH EYES, AND DISCARD VEHICLE.**
- **ONLY USE CHARGER SUPPLIED WITH THIS TOY.**
- **DO NOT USE ANY OTHER CHARGING SOURCE.**
- **DO NOT IMMERSE IN WATER.**
- **DO NOT USE WITH HOT WHEELS TRACK SYSTEM POWER CHARGER UNIT.**
- Skateboard will work with other HOT WHEELS Track .

BATTERY SAFETY INFORMATION:

1. Non-rechargeable batteries are not to be recharged.
2. Rechargeable batteries are to be removed from the toy before being charged.
3. Rechargeable batteries are only to be charged under adult supervision.
4. Do not mix alkaline, standard (carbon-zinc), or rechargeable (nickel-cadmium) batteries.
5. Do not mix old and new batteries
6. Only batteries of the same or equivalent type as recommended are to be used.
7. Batteries are to be inserted with the correct polarity.
8. Exhausted batteries are to be removed from the toy.
9. The supply terminals are not to be short-circuited.
10. Dispose of batteries safely.

ASSEMBLY

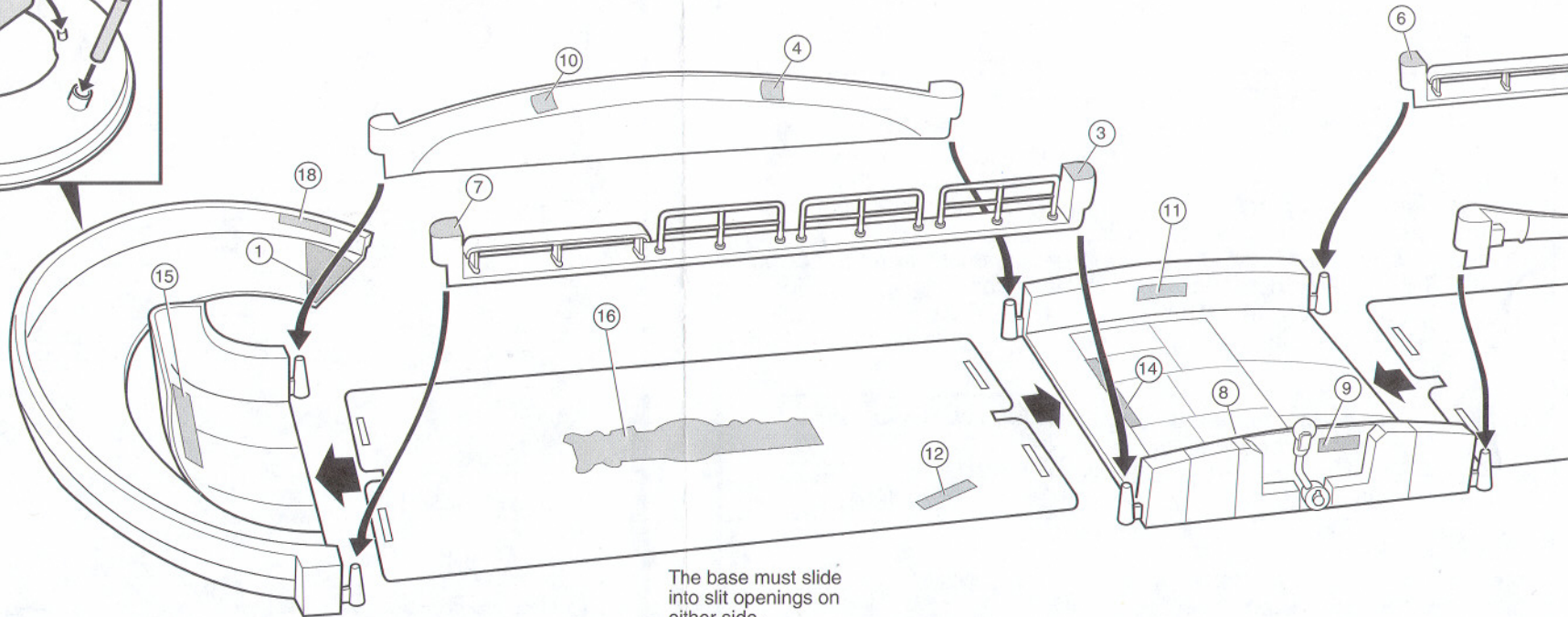
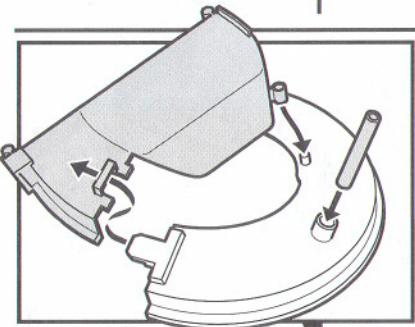

The base must slide into slit openings on either side.

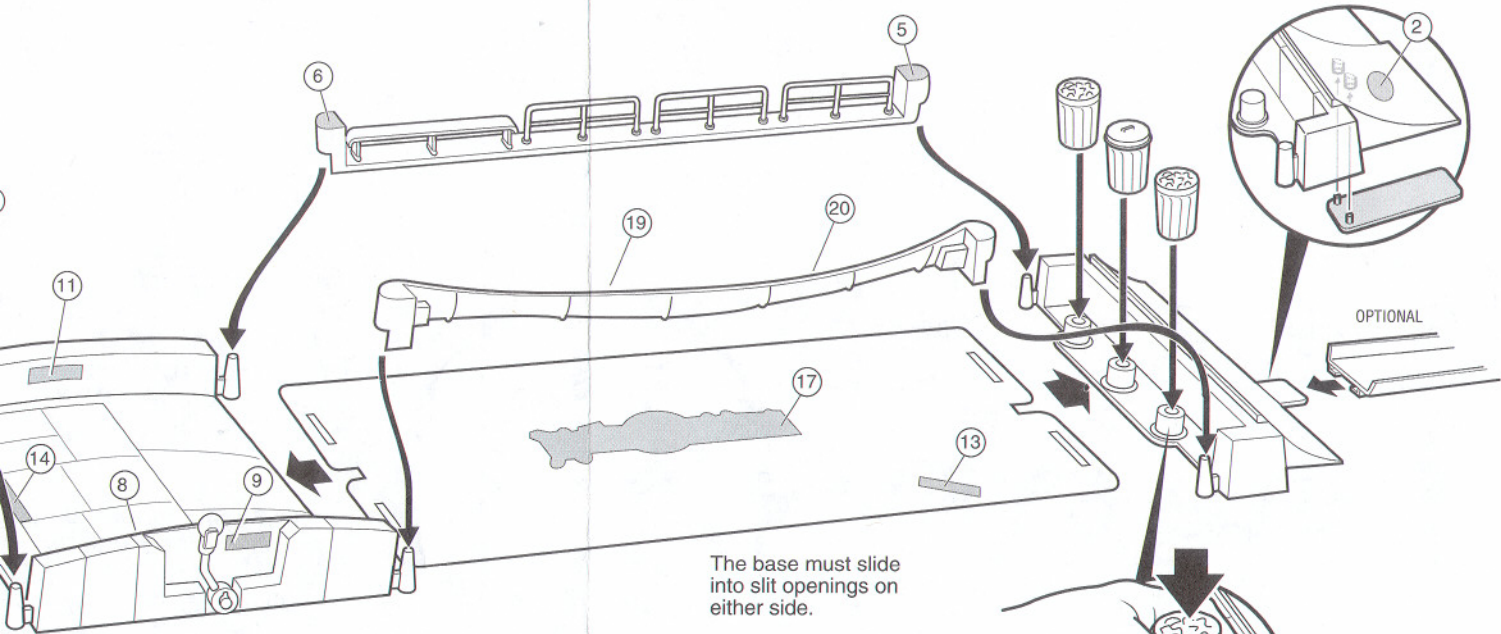

The base must slide into slit openings on either side.

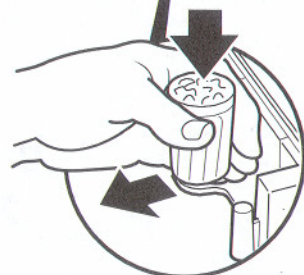

Push down and slide bottom of each can forward to lock in place.

JUST A FEW TRACK LAYOUTS

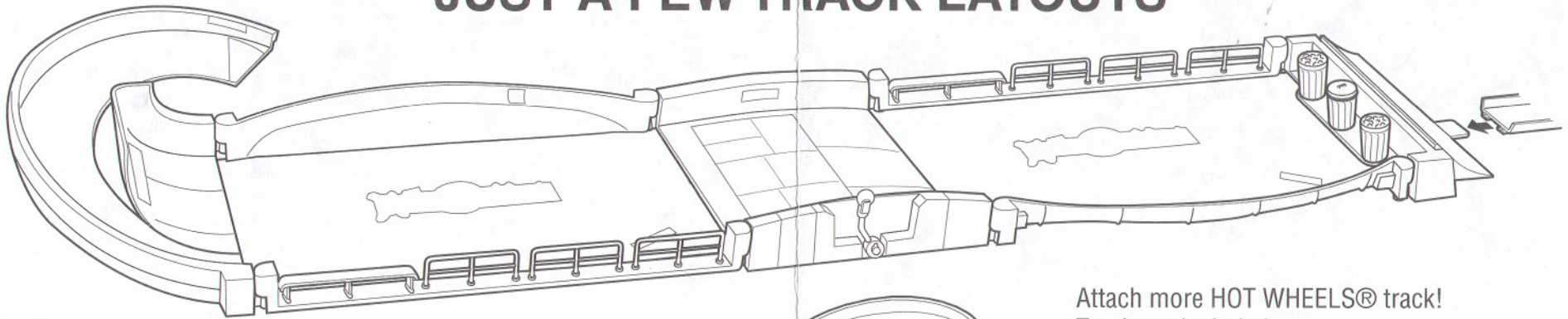

Attach more HOT WHEELS® track!
Track not included.

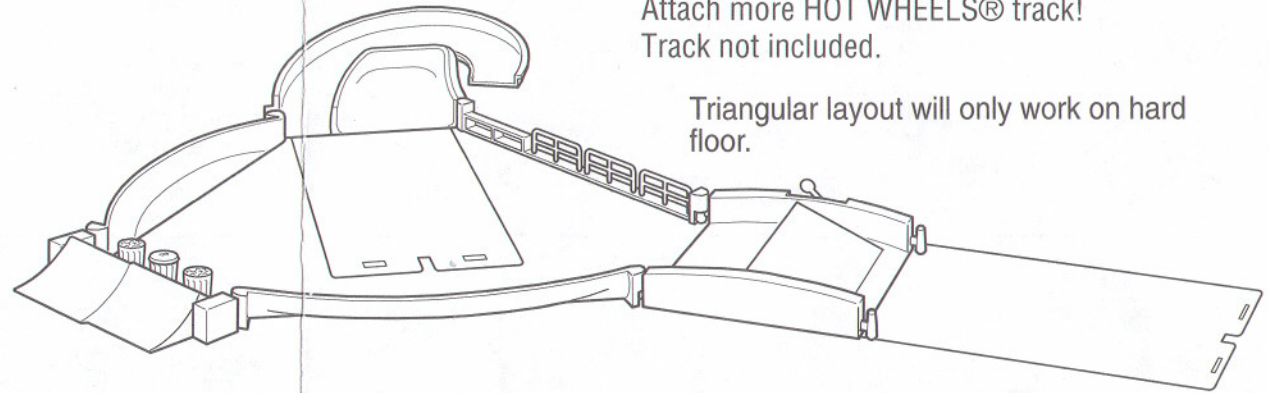

Triangular layout will only work on hard floor.

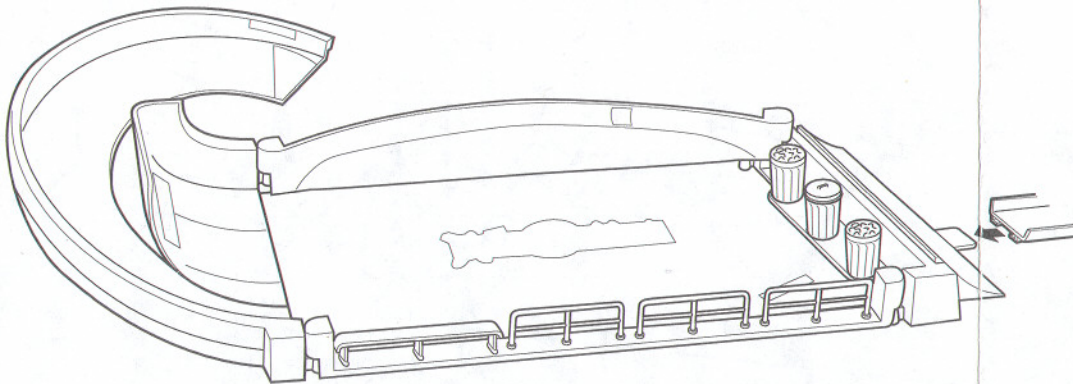

Can be reconfigured in a variety of different layouts.
Use your imagination to create more!

2 YEAR LIMITED WARRANTY

Mattel, Inc. warrants to the original consumer purchaser that this product will be free of defects in material or workmanship for two years (unless otherwise specified in alternate warranties) from the date-of-purchase. If defective, return the product along with proof of the date-of-purchase, postage prepaid, to Consumer Adjustment Center, 15930 E. Valley Boulevard, City of Industry, CA 91744 for replacement or refund at our option. This warranty does not cover damage resulting from accident, misuse or abuse. **VALID ONLY IN U.S.A.** This warranty gives you specific legal rights and you may also have other rights which vary from state to state.

Send only the product to the address above. Send all correspondence to Consumer Affairs, Mattel, Inc., 333 Continental Blvd., El Segundo, CA 90245-5012, U.S.A. Or you may phone us toll-free at 1-800-524-TOYS, Monday through Friday: 8:00 a.m.-5:00 p.m. PST (11:00 a.m.-8:00 p.m. EST).

CONSUMER INFORMATION



YOU CAN TELL IT'S MATTEL! CALL us toll-free or write with any comments or questions about our toys or service. Monday-Friday, 8:00 a.m.-5:00 p.m. PST, 11:00 a.m.-8:00 p.m. EST. Outside U.S.A., see telephone directory for Mattel listing. Consumer Affairs, Mattel, Inc., 333 Continental Blvd., El Segundo, CA 90245 USA

1 (800) 524-TOYS



CONFORMS TO THE SAFETY REQUIREMENTS OF ASTM F963.

We are dedicated to quality products.