

**Lay & play****Tummy time****Sit & play****Take-along**

Please keep this instruction sheet for future reference, as it contains important information.

Requires three AA batteries (included) for operation.

Batteries included are for demonstration purposes only.

Adult assembly is required.

Tool required for assembly: Phillips screwdriver (not included).

# Consumer Information



**CONSUMER ASSISTANCE**  
1-800-432-5437 (US & Canada)  
1300 135 312 (Australia)

**service.fisher-price.com**

---

Fisher-Price, Inc., 636 Girard Avenue, East Aurora, NY 14052.  
Hearing-impaired consumers: 1-800-382-7470.

**Outside the United States:**

Canada: Mattel Canada Inc., 6155 Freemont Blvd.,  
Mississauga, Ontario L5R 3W2; [www.service.mattel.com](http://www.service.mattel.com).

Great Britain: Mattel UK Ltd, Vanwall Business Park,  
Maidenhead SL6 4UB. Helpline: 01628 500303.  
[www.service.mattel.com/uk](http://www.service.mattel.com/uk)

Mattel Europa B.V., Gondel 1, 1186 MJ Amstelveen, Nederland.

Australia: Mattel Australia Pty. Ltd., 658 Church Street,  
Locked Bag #870, Richmond, Victoria 3121 Australia.

New Zealand: 16-18 William Pickering Drive,  
Albany 1331, Auckland.

## Care

- The mat and soft toy are machine washable. Wash separately in cold water on the gentle cycle. Do not use bleach. Tumble dry on low heat.
- The arch, toys, bases and piano can be wiped with a clean, damp cloth. Do not immerse the piano.

## Assembled Parts



### CAUTION

This package contains small parts. For adult assembly only.



Piano

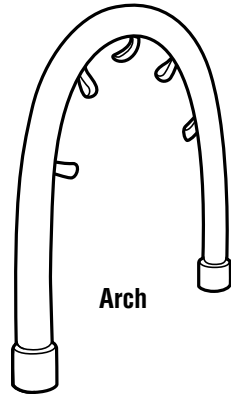

Arch



Mirror

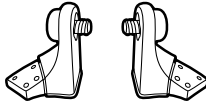

2 Hubs



2 Bases

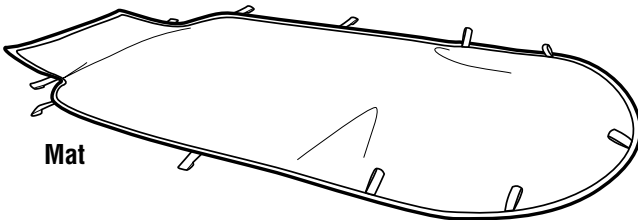

Mat

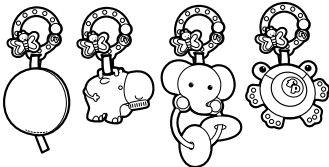

4 Hanging Toys



#6 x 1/2" (1,3 cm) Screw - 8

**SHOWN ACTUAL SIZE**

Tighten and loosen screws with a Phillips screwdriver. Do not over-tighten screws.

# Assembly

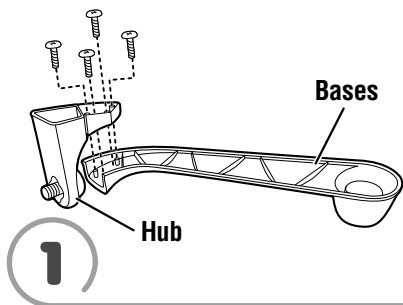

- Fit a hub to a base.

**Hint:** The hubs are designed to fit each base one way. If a hub does not seem to fit, try assembling it to the other base.

- Insert four screws into the hub and tighten.
- Repeat this procedure to assemble the other base and hub.

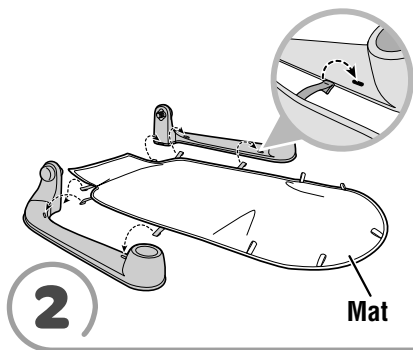

- Place the mat, print side up, between the bases.
- Fit all three straps on each side of the mat into the slots in the bases. Make sure the tab on the end of each strap forms a "T" on the other side of the slot.
- Pull up on the mat to be sure it is assembled to the bases.

The piano can be assembled to the hubs for Lay & play or Sit & play modes.

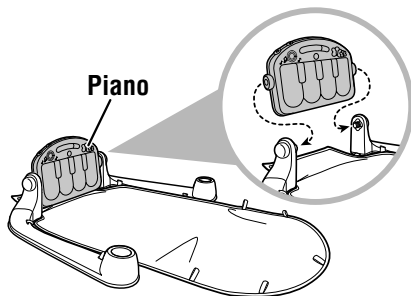

Lay & play

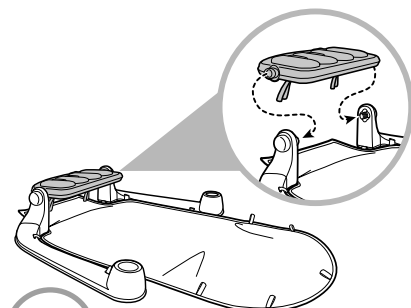

Sit & Play

- Fit the piano onto the peg on each hub.
- Tighten each hub to secure the piano in place.

# Assembly

Follow assembly steps 4 and 5 for Lay & play mode.

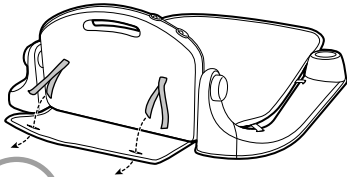

**4**

- From the back of the piano, fit a strap on each end of the piano through a button hole in the mat.

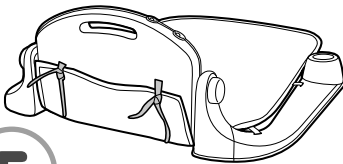

**5**

- Tie each strap to secure the mat to the piano.

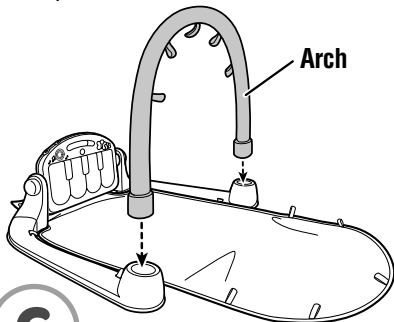

**6**

- Fit the ends of the arch into the socket in each base.

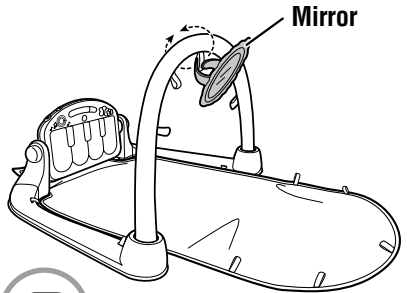

**7**

- Secure the fasteners on the mirror to the arch.

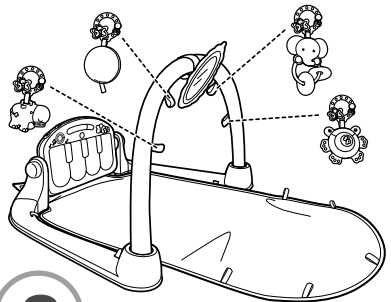

**8**

- Attach the toys to any of the loops on the arch or the mat.

## Battery Replacement

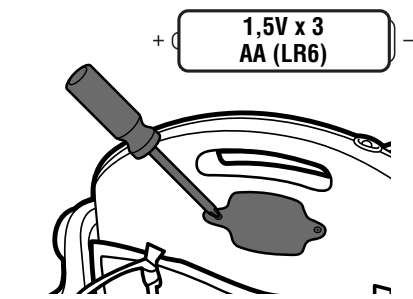

- For longer life, use **alkaline** batteries.
- Locate the battery compartment door on the back of the piano.
- Loosen the screws in the battery compartment door with a Phillips screwdriver and remove the door.
- Remove the exhausted batteries and dispose of them properly.
- Insert three, new AA (LR6) **alkaline** batteries.
- Replace the battery compartment door and tighten the screws. Do not over-tighten.
- If this product begins to operate erratically, you may need to reset the electronics. Slide the power/mode switch off and then back on.
- When sounds become faint or stop, it's time for an adult to change the batteries.



- Protect the environment by not disposing of this product with household waste (2002/96/EC). Check your local authority for recycling advice and facilities.

## Battery Safety Information

In exceptional circumstances, batteries may leak fluids that can cause a chemical burn injury or ruin your product. To avoid battery leakage:





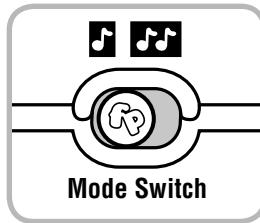
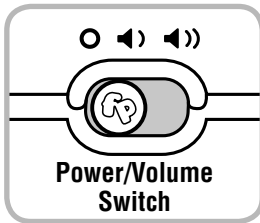

- Do not mix old and new batteries or batteries of different types: alkaline, standard (carbon-zinc) or rechargeable (nickel-cadmium).
- Insert batteries as indicated inside the battery compartment.
- Remove batteries during long periods of non-use. Always remove exhausted batteries from the product. Dispose of batteries safely. Do not dispose of this product in a fire. The batteries inside may explode or leak.
- Never short-circuit the battery terminals.
- Use only batteries of the same or equivalent type, as recommended.
- Do not charge non-rechargeable batteries.
- Remove rechargeable batteries from the product before charging.
- If removable, rechargeable batteries are used, they are only to be charged under adult supervision.

# Musical Fun!



Loosen the pegs on the supports and remove the piano for take-along fun!



- Slide the power/volume switch to ON with low volume  or ON with high volume  or OFF .
- Slide the mode switch to  **Long Play** or  **Short Play** mode.
  -  **Long Play** - press a button to play music (up to 15 minutes).
  -  **Short Play** - press a button to play a note and a short ditty.



## WARNING

To prevent entanglement injury, never place the gym in a crib or playpen. Never add strings, ties or other products to the gym.

# Consumer Information

## **FCC Statement (United States Only)**

This equipment has been tested and found to comply with the limits for a Class B digital device, pursuant to Part 15 of the FCC Rules. These limits are designed to provide reasonable protection against harmful interference in a residential installation. This equipment generates, uses and can radiate radio frequency energy and, if not installed and used in accordance with the instructions, may cause harmful interference to radio communications. However, there is no guarantee that interference will not occur in a particular installation. If this equipment does cause harmful interference to radio or television reception, which can be determined by turning the equipment off and on, the user is encouraged to try to correct the interference by one or more of the following measures:

- Reorient or relocate the receiving antenna.
- Increase the separation between the equipment and receiver.
- Consult the dealer or an experienced radio/TV technician for help.

Note: Changes or modifications not expressly approved by the manufacturer responsible for compliance could void the user's authority to operate the equipment. This device complies with Part 15 of the FCC Rules. Operation is subject to the following two conditions: (1) this device may not cause harmful interference and (2) this device must accept any interference received, including interference that may cause undesired operation.

## **ICES-003**

This Class B digital apparatus complies with Canadian ICES-003. Operation is subject to the following two conditions: (1) this device may not cause harmful interference and (2) this device must accept any interference received, including interference that may cause undesired operation.

## **NMB-003**

Cet appareil numérique de la classe B est conforme à la norme NMB-003 du Canada. L'utilisation de ce dispositif est autorisée seulement aux conditions suivantes: (1) il ne doit pas produire de brouillage et (2) l'utilisateur du dispositif doit être prêt à accepter tout brouillage radioélectrique reçu, même si ce brouillage est susceptible de compromettre le fonctionnement du dispositif.