

Fisher-Price®

Y3610, BMM13



Scan the QR code below  
to download the app



Interactive  
games &  
activities!

- 1 Download Imaginext™ Apptivity™ Fortress app. Scan QR code below or go to App Store<sup>SM</sup>.

- 2 Open playset case. Plug case audio pin into device headphone jack.

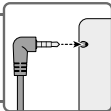

- 3 Turn playset and device power **ON**. Close case.



- 4 Turn OFF Multitasking Gestures (located in device Settings).



- 5 Launch app.



## Consumer Information

- Please keep this instruction sheet for future reference, as it contains important information.
- Requires three AA (LR6) **alkaline** batteries (not included) for operation.
- Adult assembly is required. Tool required for battery installation: Phillips screwdriver (not included).
- This product is compatible with first, second and third generation iPad®, and the new iPad® with Retina display. Device not included.
- The Augmented Reality (AR) features (using the device's camera) of this app only work with iPad® devices that have a camera.
- Only use this product with your iPad® device properly inserted and locked in the case. Remove any other cases from the device before inserting it in the case.
- Periodically check this product and your device for damage or cracks. Do not use if either is damaged or broken. Follow your device's instructions for use and care.
- Wipe this product with a clean, damp cloth. Do not immerse. Do not use alcohol or ammonia based cleaners on the screen protector.

### Battery Safety Information

In exceptional circumstances, batteries may leak fluids that can cause a chemical burn injury or ruin your product. To avoid battery leakage:

- Do not mix old and new batteries or batteries of different types: alkaline, standard (carbon-zinc) or rechargeable (nickel-cadmium).
- Insert batteries as indicated inside the battery compartment.
- Remove batteries during long periods of non-use. Always remove exhausted batteries from the product. Dispose of batteries safely. Do not dispose of this product in a fire. The batteries inside may explode or leak.
- Never short-circuit the battery terminals.
- Use only batteries of the same or equivalent type, as recommended.
- Do not charge non-rechargeable batteries.
- Remove rechargeable batteries from the product before charging.
- If removable, rechargeable batteries are used, they are only to be charged under adult supervision.

## Battery Installation



For longer life, use  
**alkaline** batteries.

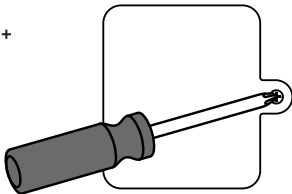

Protect the environment  
by not disposing of this  
product with household  
waste (2002/96/EC).  
Check your local  
authority for recycling  
advice and facilities.

- Locate the battery compartment door on the bottom of the playset.
- Loosen the screw in the battery compartment door with a Phillips screwdriver and remove the door.
- Insert three AA (LR6) **alkaline** batteries.
- Replace the battery compartment door and tighten the screw. Do not over-tighten.
- If this toy begins to operate erratically, you may need to reset the electronics. Slide the power switch OFF and back ON. If resetting does not help, it's time for an adult to change the batteries.

## One-Time Assembly

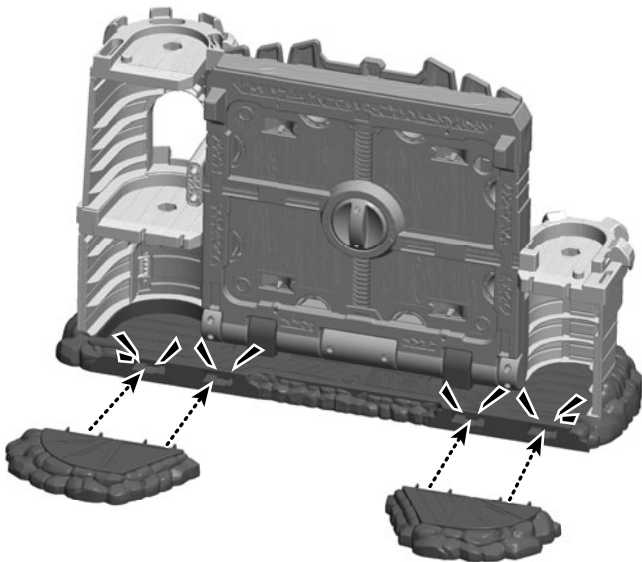

- Fit each base into the slots on the back of the playset and push to “**snap**” in place.

*Hint: Each base is designed to fit one way. If it does not seem to fit, try the other base.*

## Setup

1

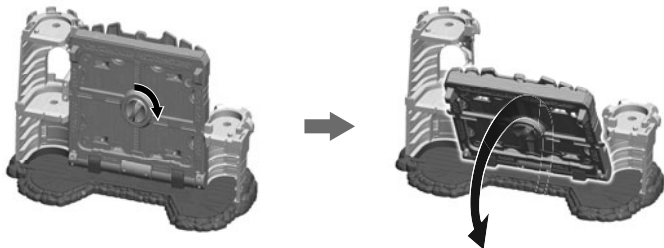

### Lower Case

- Turn the dial to the unlock position. Lower the case.

2

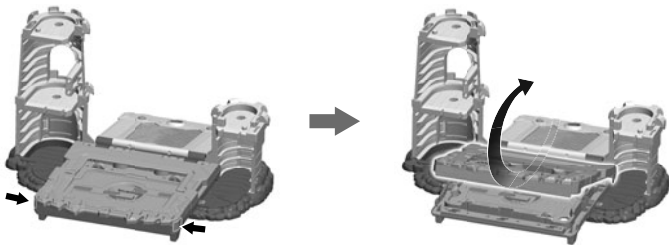

### Open Case

- While pressing the buttons on each side of the case, lift the screen protector.

## Setup

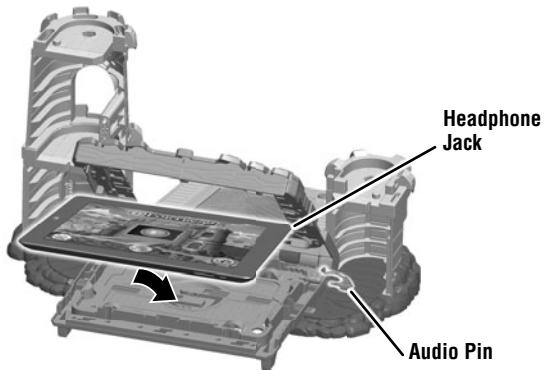

3

### Insert Device

- Remove any other case from the device before inserting it in this toy.
- Turn device power ON.
- Insert the device with the headphone jack next to the audio pin inside the case.

## Setup

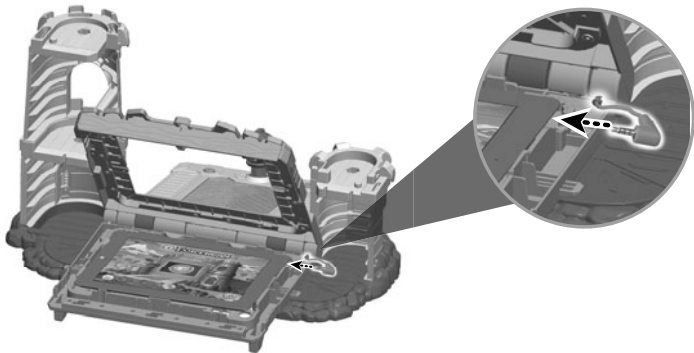

4

### Insert Audio Pin

- Plug the audio pin attached to the case into the headphone jack on the device.

**IMPORTANT!** To ensure proper interaction between your device and this toy, make sure the audio pin is **inserted completely** into the device headphone jack.

## Setup

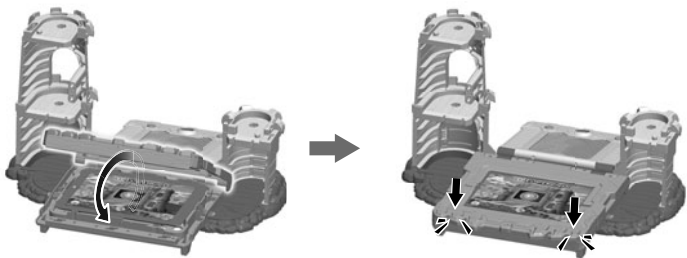

5

### Close Case

- Lower the screen protector and push until it “snaps” closed.

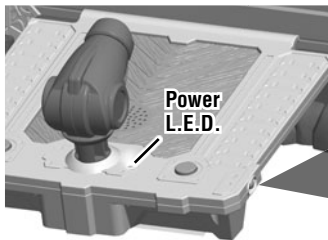

6

### Power Switch

- Slide the power switch ON ●. The power L.E.D. lights. When finished, slide the power switch OFF ○.



## Defend the Fortress!

Imaginext™ Apptivity™ Fortress app can be played in **horizontal (flat)** or **vertical (upright)** mode.

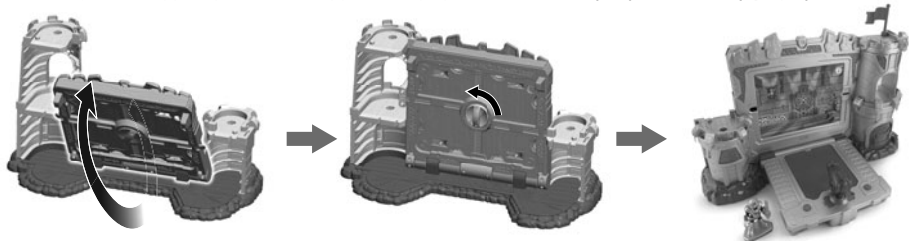

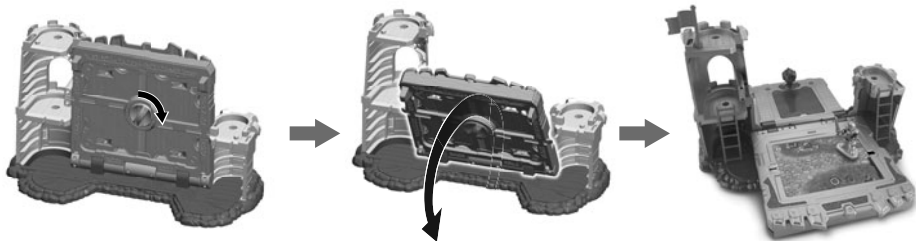

- For **vertical play**, explore the great hall of the castle and play the cannon game!
- With your device inside the case, lift the case and turn the dial to the lock position.



- For **horizontal play**, explore the courtyard, collect gold and play more games! Use the enclosed figure on the screen.
- Turn the dial to the unlock position and carefully lower the case.



# Imaginext™ Apptivity™ Fortress



- From the main menu, touch the arrow in the middle of the screen to begin.
- Touch  to see how much gold has been collected and to purchase more gold to unlock new digital characters.
- Touch the  to go to the app Settings menu. From the app Settings menu, you can: turn background music ON or OFF; adjust app volume and adjust cannon aiming. You will also find help. Touch the Frequently Asked Questions (FAQs) button.

## Vertical Play



- Welcome to the great hall. Touch objects on the screen to see what they do. Swipe the screen to continue down the hall. Take a picture and hang it on the wall.
- For more to do, touch the glowing disk  for a menu. Touch the broom  to clean-up. Touch the treasure chest  to go to the treasure room. Here you can see how much gold you've collected and purchase items or digital characters to add to your adventure.





## Vertical Play



- Touch a door to enter the room and play a game. If the door is locked, you'll need to purchase (sold separately) a digital character for access. Go to the treasure room to use your gold/buy more gold. You can also purchase additional figures (sold separately and subject to availability).





## Vertical Play



- After opening the door to the knight's room, touch objects on the screen to see what each does.
- Touch the suit of armor and watch it fall to pieces!. Then put it back on the rack, one piece at a time.
- Touch the glowing disk  for a menu. Touch the broom  to clean-up. Touch the tower  to go back to the great hall.
- Touch the cannon  to go to the cannon game.







## Vertical Play



- Place the cannon in socket on the playset drawbridge.
- Move the cannon to aim at a troll. Then press a button to fire! Or use your finger to move the crosshair to aim. Then tap the screen to fire!
- Touch the glowing disk  for a menu. Touch the curved arrow  to replay the game. Touch the door  to go back to the the knight room. Touch the tower  to go back to the great hall.

## Horizontal Play



- Place the enclosed figure on the blinking print on the screen. Move the figure to explore the courtyard, collect gold and play games. You can use your fingers to play too. Simply place two fingers anywhere on the screen to play as a digital player.
- Touch the glowing disk  for a menu. Touch the treasure chest  to go to the treasure room. Here you can see how much gold you've collected and purchase items or digital characters to add to your adventure. Touch the map  to go directly to a game. Touch the character  to switch characters.
- Follow the directions in each game to play! To play a game again, touch the glowing disk  for a menu. Then touch the curved arrow . To exit a game and go back to the courtyard, touch the tent .

## Treasure Room



- Look at the number at the top of the screen to see how much gold you've collected playing.
- If you'd like to purchase additional digital characters or objects, touch one of the buttons on the screen. Do you have enough gold?
- To purchase the digital character or object, touch the "Buy" button on the bottom center of the screen. If you don't have enough gold, touch the "Buy Gold" button on the bottom right side of the screen.



## Tips

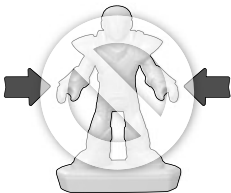

- 
- When using on the screen to interact with the app, do not hold the figure by the arms.
  - Always use the figure **flat** on the screen. The small conductive posts on the bottom side of the figure must always contact the screen.
  - Always **hold** the figure **throughout** play.
  - If a figure does not respond with the app, make sure the bottom of the figure and the screen protector are clean. Wipe the figure with a clean cloth. Wipe the screen protector with a clean cloth. Do not use alcohol or ammonia based cleaners on the screen protector.
  - The sound in the app will time out after one minute. After another minute, the power on the playset will time out. Press a button on the playset or touch the screen to wake up.
  - Your device's screen will turn off after the time that is set in your device's "Auto-Lock" settings menu (2/5/10/15min/Never).
  - If you cannot hear sounds from the playset after installing the device, make sure the playset audio pin is inserted into the device headphone jack and playset power is ON.

## Tips

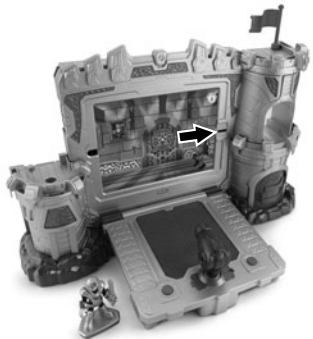

- To exit the app at any time, simply slide the door on the screen to access your device's home button.
- To get back to the app main menu, you'll need to exit the app, and then launch it again.
- If the app closes unexpectedly, or you exit the app during play, we recommend turning OFF (disable) "Multitasking Gestures".
- To turn OFF (or disable) this feature on your device, select Settings. On the left side of the screen, choose General. In the Multitasking Gestures tab, touch the switch to turn OFF this feature.

# Consumer Information

## FCC Statement (United States Only)

This equipment has been tested and found to comply with the limits for a Class B digital device, pursuant to Part 15 of the FCC Rules. These limits are designed to provide reasonable protection against harmful interference in a residential installation. This equipment generates, uses and can radiate radio frequency energy and, if not installed and used in accordance with the instructions, may cause harmful interference to radio communications. However, there is no guarantee that interference will not occur in a particular installation. If this equipment does cause harmful interference to radio or television reception, which can be determined by turning the equipment off and on, the user is encouraged to try to correct the interference by one or more of the following measures:

- Reorient or relocate the receiving antenna.
- Increase the separation between the equipment and receiver.
- Consult the dealer or an experienced radio/TV technician for help.

Note: Changes or modifications not expressly approved by the manufacturer responsible for compliance could void the user's authority to operate the equipment.

This device complies with Part 15 of the FCC Rules. Operation is subject to the following two conditions: (1) this device may not cause harmful interference and (2) this device must accept any interference received, including interference that may cause undesired operation.

## ICES-003

This Class B digital apparatus complies with Canadian ICES-003. Operation is subject to the following two conditions: (1) this device may not cause harmful interference and (2) this device must accept any interference received, including interference that may cause undesired operation.

## NMB-003

Cet appareil numérique de la classe B est conforme à la norme NMB-003 du Canada. L'utilisation de ce dispositif est autorisée seulement aux conditions suivantes: (1) il ne doit pas produire de brouillage et (2) l'utilisateur du dispositif doit être prêt à accepter tout brouillage radioélectrique reçu, même si ce brouillage est susceptible de compromettre le fonctionnement du dispositif.



## CONSUMER ASSISTANCE

1-800-432-5437 (US & Canada)  
1300 135 312 (Australia)

**service.fisher-price.com**

Fisher-Price, Inc., 636 Girard Avenue, East Aurora, NY 14052.  
Hearing-impaired consumers: 1-800-382-7470.

### **Outside the United States:**

Canada: Mattel Canada Inc., 6155 Freemont Blvd.,  
Mississauga, Ontario L5R 3W2; [www.service.mattel.com](http://www.service.mattel.com).

Great Britain: Mattel UK Ltd, Vanwall Business Park,  
Maidenhead SL6 4UB. Helpline: 01628 500303.  
[www.service.mattel.com/uk](http://www.service.mattel.com/uk)

Mattel Europa B.V., Gondel 1, 1186 MJ Amstelveen, Nederland.

Australia: Mattel Australia Pty. Ltd., 658 Church Street,  
Locked Bag #870, Richmond, Victoria 3121 Australia.

New Zealand: 16-18 William Pickering Drive,  
Albany 1331, Auckland.

Apple, the Apple logo and iPad® are trademarks of Apple, Inc., registered in the US and other countries.  
App Store is a service mark of Apple, Inc.

©2013 Mattel. All Rights Reserved. ® and ™ designate U.S. trademarks of Mattel, except as noted.