

What's her face!

INSTRUCTIONS

CONTENTS

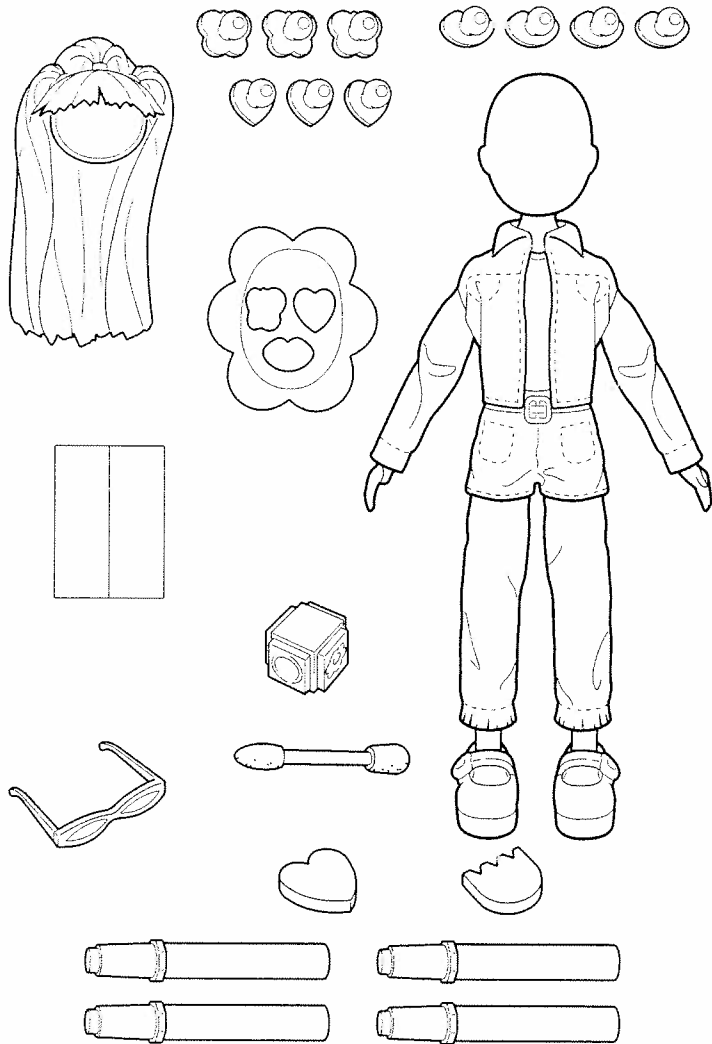

Colors and decorations may vary from those shown.

Please remove everything from the package and compare to the contents shown here. If any items are missing, please call 1-800-524-TOYS.



54237-0920

Keep these instructions for future reference as they contain important information.

©2001 Mattel, Inc. El Segundo, CA 90245 U.S.A. All Rights Reserved.

Flip the card for creative ideas!

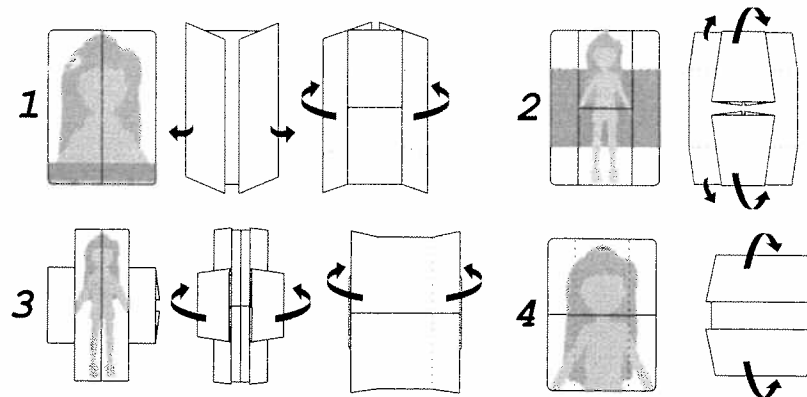

Use only the washable color markers that come with this toy. Do not use other color pens as they may permanently stain the toy. Apply marker pens on doll's face and doll clothes only. The marker inks are washable but may stain other fabrics and surfaces. Avoid contact with carpet, clothing, walls and furniture. Protect play area before use. SAFETYTESTED.

Drain, clean and dry all items before storing. Color change will last longer if you do not expose hair to intense heat or direct sunlight for prolonged periods of time.

Recap marker pens quickly after use to prevent inks from drying out.

TWO YEAR LIMITED WARRANTY

Mattel, Inc. warrants to the original consumer purchaser that this product will be free of defects in material or workmanship for two years (unless specified in alternate warranties) from the date of purchase. If defective, return the product along with proof of the date of purchase, postage prepaid, to Consumer Relations, 636 Girard Avenue, East Aurora, New York 14052 for replacement or refund at our option. This warranty does not cover damage resulting from unauthorized modification, accident, misuse or abuse. In no event shall we be responsible for incidental, consequential, or contingent damages (except in those states that do not allow this exclusion or limitation). **VALID ONLY IN U.S.A.** This warranty gives you specific legal rights and you may also have other rights which vary from state to state. Some states do not allow the exclusion of incidental or consequential damages, so the above exclusions or limitations may not apply to you.

Send only the product to the address above. Send all correspondence to Consumer Relations, Mattel, Inc., 333 Continental Blvd., El Segundo, California 90245-5012 U.S.A. Or you may phone us toll-free at 1-800-524-TOYS, Monday - Friday, 8:00 a.m. - 6:00 p.m. Eastern Time. Outside U.S.A., see telephone directory for Mattel listing.

CONSUMER INFORMATION

MATTY MATTEL™ Toys



YOU CAN TELL IT'S MATTTEL!™ CALL us toll-free or write with any comments or questions about our products or service. Monday-Friday 8:00 a.m.-6:00 p.m. Eastern Time. Outside U.S.A., see telephone directory for Mattel listing.

Consumer Relations, Mattel, Inc.
333 Continental Blvd.
El Segundo, CA 90245 USA

1 (800) 524-TOYS

WE ARE DEDICATED TO QUALITY PRODUCTS.

WARNING:

CHOKING HAZARD - Small parts.
Not for children under 3 years.

Decorate with markers & cool stampers again & again!

1

With the doll not wearing a wig, place the mask on doll's face.



2

Color a stamper with a marker. Stamp quickly so the ink does not dry out on the stamper.

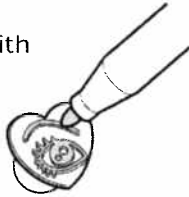

3

Press the stamper through the corresponding shaped opening in the mask.

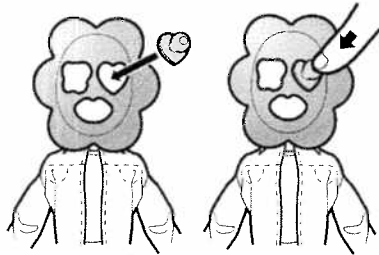

4

Create an **outline** by stamping the eyes and mouth on your doll's face. Finish by coloring in the outlines! Clean stamper thoroughly before applying a new color.

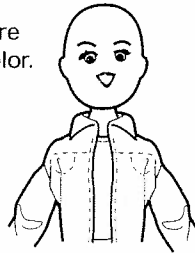

Use only What's Her Face™ markers on this product.

5

Dampen the sponge applicator with water to erase your doll's face.

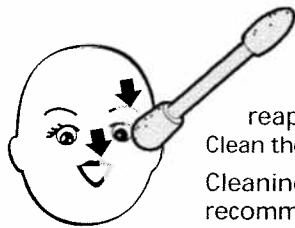

Completely wipe the face clean with the sponge applicator. Dry the face before reapplying. Clean the applicator afterwards if necessary. Cleaning the doll before storage is recommended.

There are 3 ways to play...

1. Use the mask with the stampers, as shown.
2. Use the stampers without the mask.
3. Draw freehand with no mask or stampers, just using the pens.

Decorate your doll's clothes too

1

Color a stamper with a marker. Stamp quickly so the ink does not dry out on the stamper.

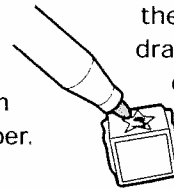

2

Press the stamper on the doll's clothes. You can also use the markers to draw your own designs on the doll's clothes.



3

Wash off markers to decorate again and again. (See step 5 under the face decorating section.)

Always re-cap your marker when not in use.

If your marker does become dry, you can reactivate it by dipping the marker into warm water for a few minutes.

Your doll's wig

Attach the wig's fabric fastener to the matching piece of fabric fastener on the doll's head.



Streaking doll's wig

Dip the sponge applicator in cold water. Apply the wet sponge to the wig's streaks. It changes color!

Only the streaks in the hair will change color. Use warm water to change back to original color.

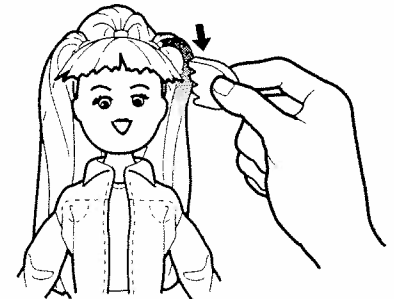

The pants become shorts

The doll's pants transform into shorts by removing the bottom part of the pants. The bottom part simply slips on and off.

