

Barbie®

2 YEAR LIMITED WARRANTY

ARCOTOYS, INC., A Mattel Company, warrants to the original consumer purchaser that this toy product will be free from defects in material or workmanship for 2 years (unless otherwise specified in alternate warranties) from the date of purchase. If defective, return the product along with proof of the date-of-purchase, postage prepaid, to Consumer Adjustment Center, ARCOTOYS, INC., A Mattel Company, C.S. #9008, Crossways Park West, Woodbury, New York 11797 for replacement or refund at our option, or you may phone us toll-free at 1 (800) 442-2664 (USA), Monday thru Friday between the hours of 10:00 A.M. - 5:00 P.M. EST (7:00 A.M. - 2:00 P.M. PST). This warranty does not cover damage resulting from accident, misuse or abuse. **VALID ONLY IN U.S.A.** This warranty gives you specific legal rights and you may also have other rights which vary from state to state.

03

UNASSEMBLED

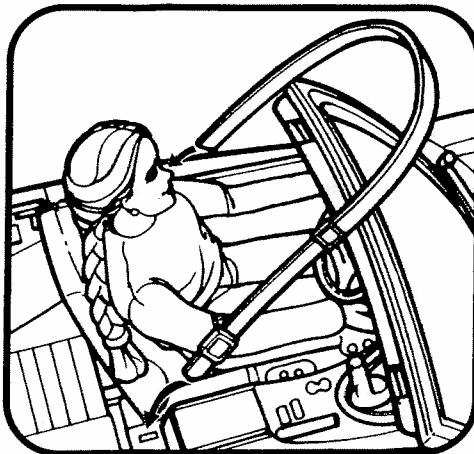
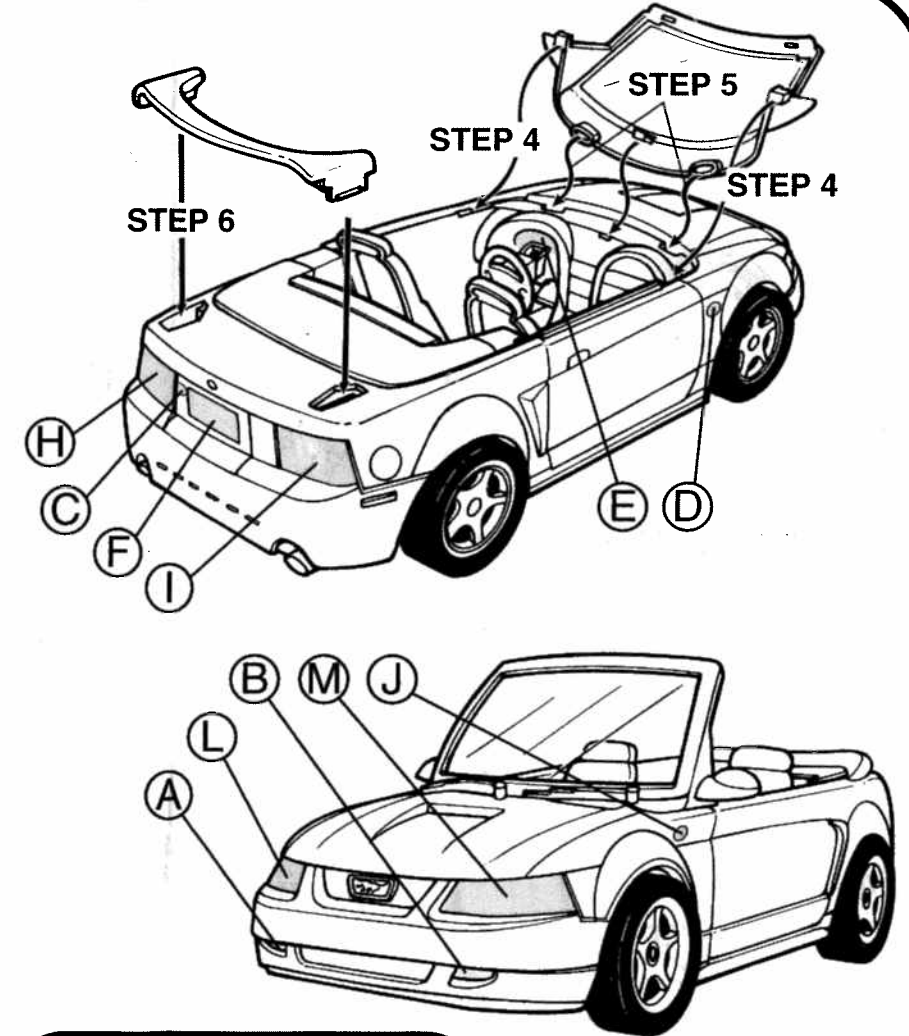
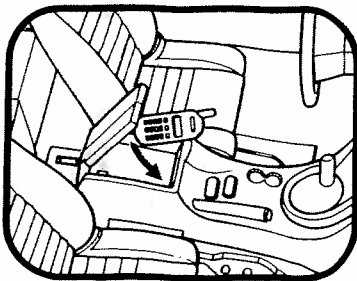
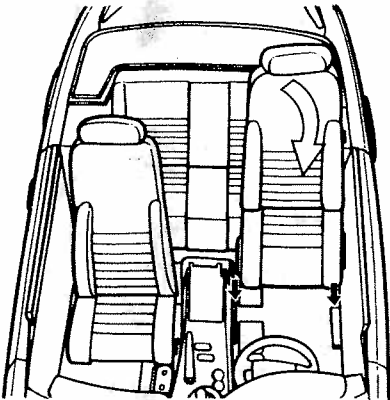
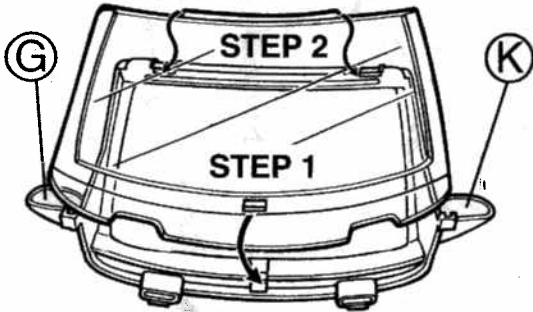
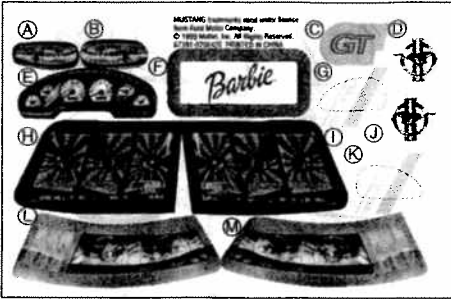

DOLL NOT INCLUDED



© 1999 Mattel, Inc. All Rights Reserved.

WARNING:

CHOKING HAZARD - Small parts.
Not for children under 3 years.

MUSTANG trademarks used under license from Ford Motor Company.

Goodyear (and winged foot design) and Eagle are trademarks of The Goodyear Tire & Rubber Company.

67391-0700401-RC1-99/9

PRINTED IN CHINA

Retain this address for future reference:

Mattel U.K., Ltd., Meridian West, Leicester LE3 2WT

OPEN

1.

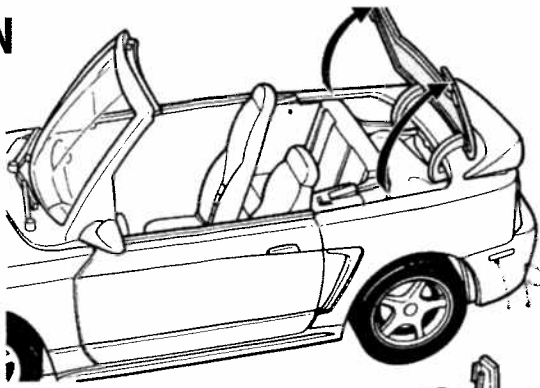

2.

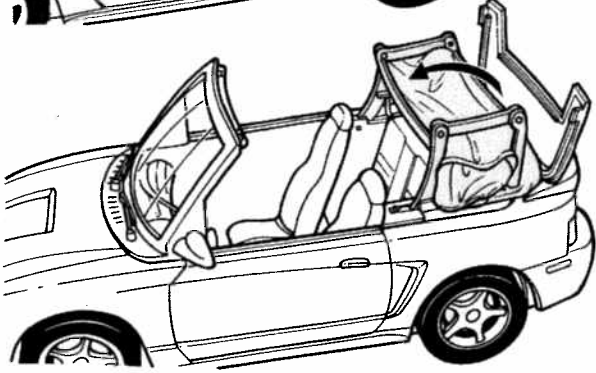

3.

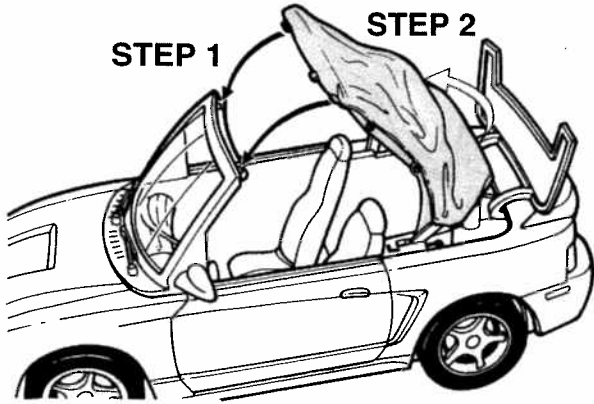

4.

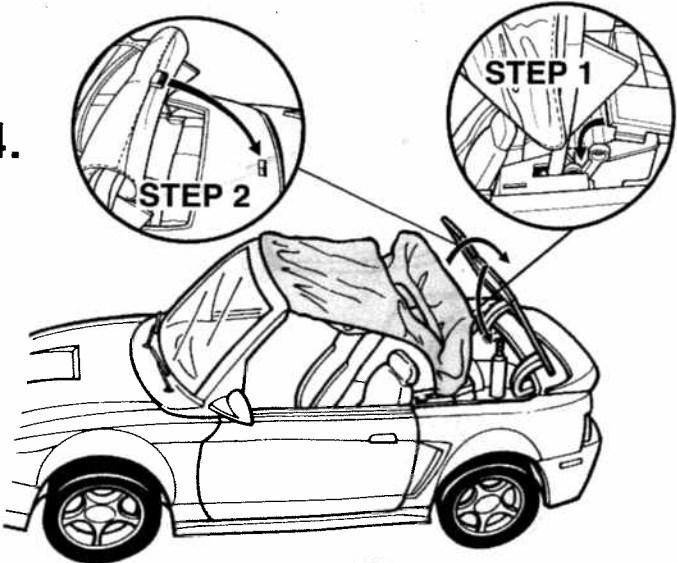

5.



CLOSE

1.

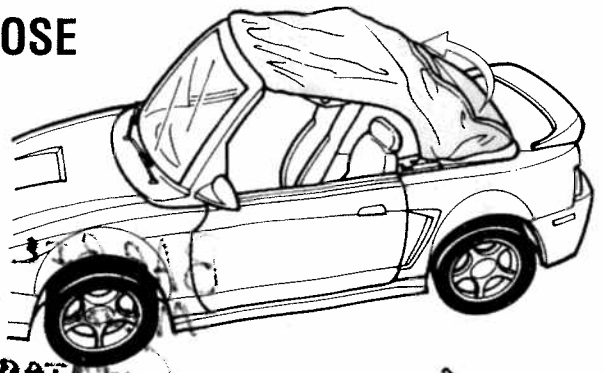

2.

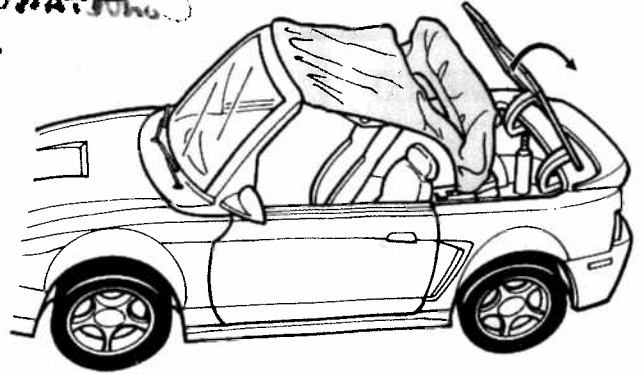

3.

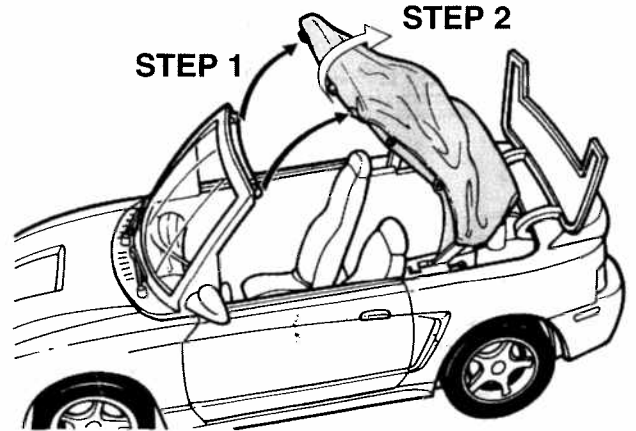

4.

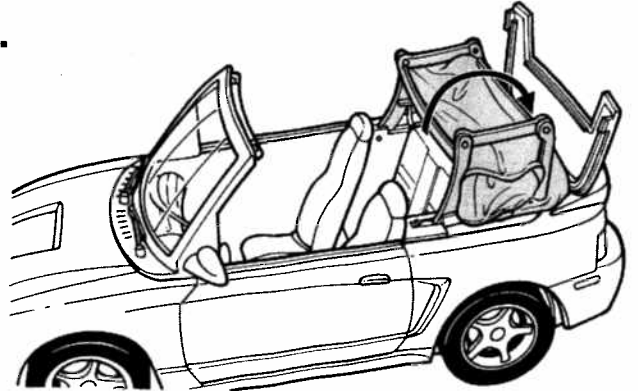

5.

