



BIG JAKE™ DUMP TRUCK ASSEMBLY MANUAL

INTERMEDIATE SERIES VEHICLE • USE A TYPE H BATTERY ONLY
FOR MODELS 85700 / 4550 / 74550



⚠ WARNING

Children can be harmed by the small parts, sharp edges and sharp points in the unassembled state, or by electrical items. Care should be taken in unpacking and assembly of the vehicle. Children should NOT handle parts, batteries, or help in assembly.

POWER WHEELS® HAS THE MOST COMPREHENSIVE SERVICE PROGRAM IN THE TOY INDUSTRY

TOLL-FREE SERVICE LINES

- Multi (twenty-five) service lines, open from 8:00 AM to 7:00 PM Monday through Friday, and Saturdays 9:00 AM to 5:00 PM

1-800-348-0751

- ¿Habla Español? Si usted tiene alguna pregunta ó necesita asistencia llame gratis **1-800-348-0755** para los Estados Unidos.

A NATIONAL SERVICE CENTER NETWORK

- Over 300 service centers nationwide
- Our service centers will repair or replace parts under warranty at no charge
- For vehicles beyond warranty, our service centers will perform repairs for a minimal charge

IMPORTANT BATTERY INFORMATION

ALWAYS CHARGE THE BATTERY A FULL 18 HOURS THE FIRST TIME. AFTER THAT, RECHARGE FOR 14 HOURS.

THIS VEHICLE USES A POWER WHEELS® TYPE H BATTERY AND A POWER WHEELS TYPE H CHARGER ONLY. NO OTHER TYPE WILL WORK. Even with proper care, the rechargeable battery will not last forever. The replacement battery **must be a Type H battery.**

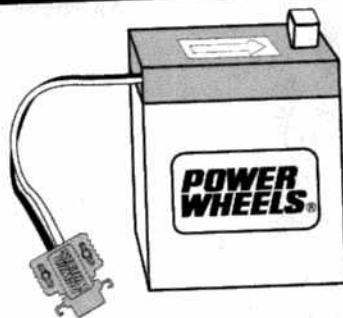

To purchase, contact:

- Dealer where your vehicle was purchased.
- Authorized Service Center (See Authorized Service Center list).
- Power Wheels Customer Service 1-800-348-0751

IMPORTANT

In the unlikely event that any of the parts are missing or damaged, contact customer service 1-800-348-0751.

TOOLS NEEDED (NOT INCLUDED)

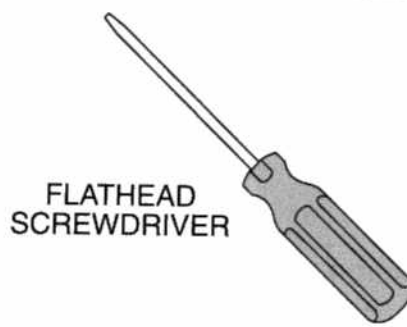

LARGE PARTS BAG

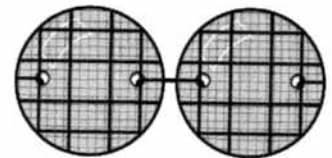
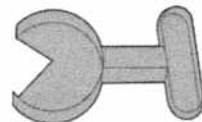
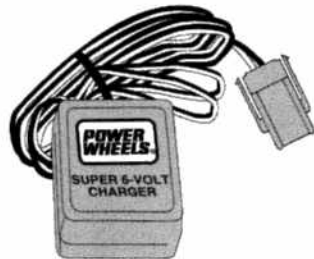
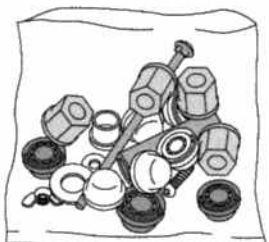

SMALL PARTS BAG

SUPER 6™ VOLT
CHARGER

SHIFT LEVER

HEADLIGHT GUARD/
LENS ASSEMBLY SET

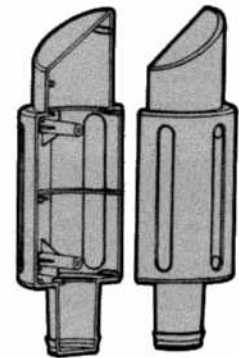
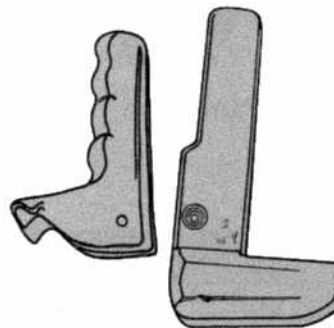
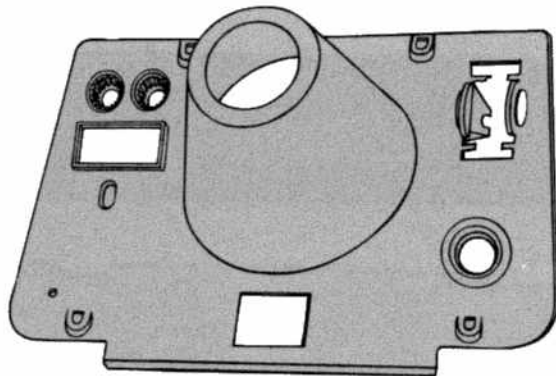

DASH

LATCH RELEASE
MECHANISM SET

EXHAUST
STACK

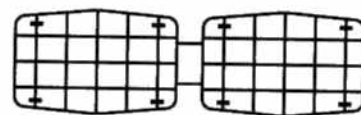

REAR LIGHT GUARD SET

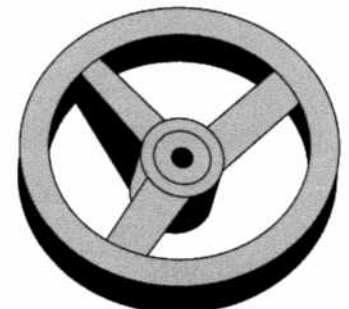
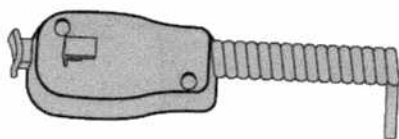

MICROPHONE

DUMP PIVOT PIN

STEERING WHEEL

NOT SHOWN:
LITERATURE BAG



BATTERY RETAINER

SMALL PARTS BAG

CAUTION: NEVER LEAVE THESE PARTS IN THE PRESENCE OF SMALL CHILDREN

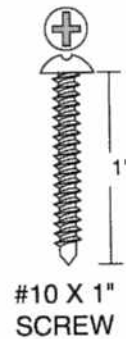
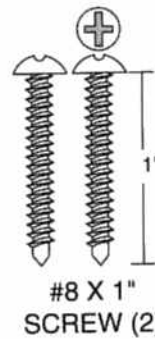
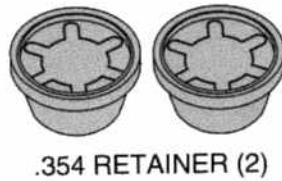
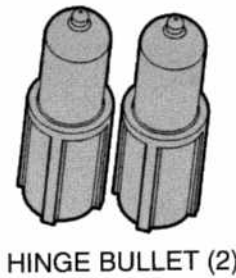
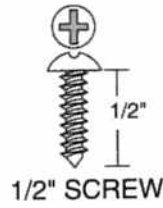
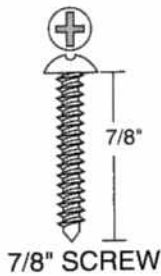
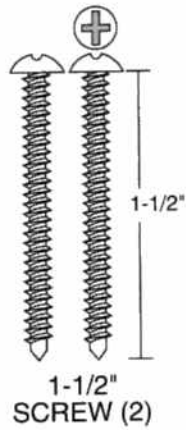
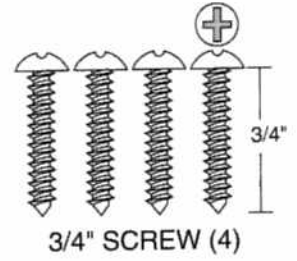
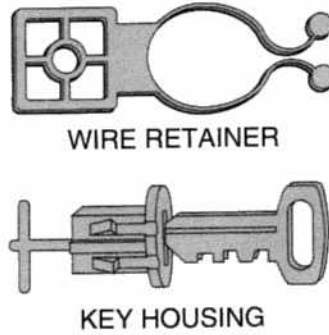
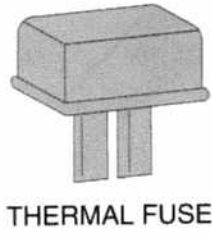
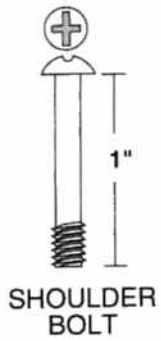

ADDITIONAL ITEMS

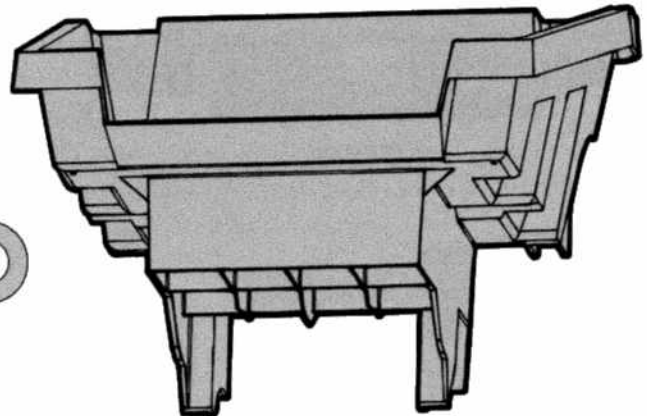
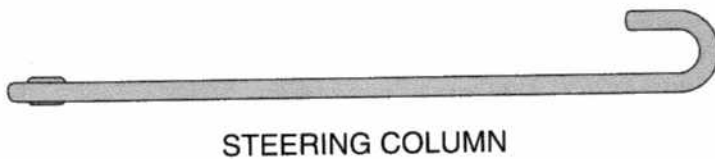

NOT SHOWN:
DECAL SHEET
BATTERY

A

BATTERY CHARGING

FOLLOW EACH STEP CAREFULLY

It is important that you use only a Power Wheels® Type H battery.

This battery has the correct plug connectors and dimensions necessary for proper battery compartment fit.

For more information on this 6-volt Type H battery, please refer to your Owner's Manual.

ASSEMBLY
BY

**ADULTS
ONLY**

**DO NOT
OMIT ANY
STEPS**

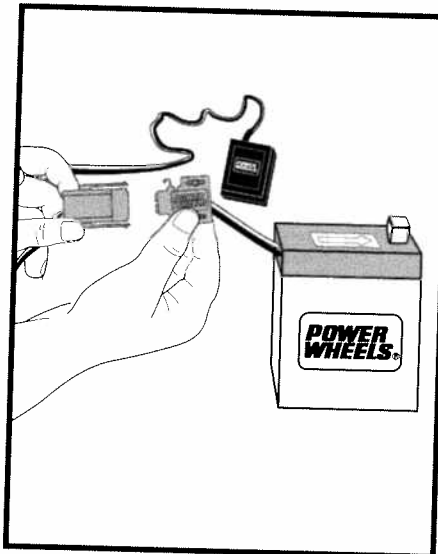
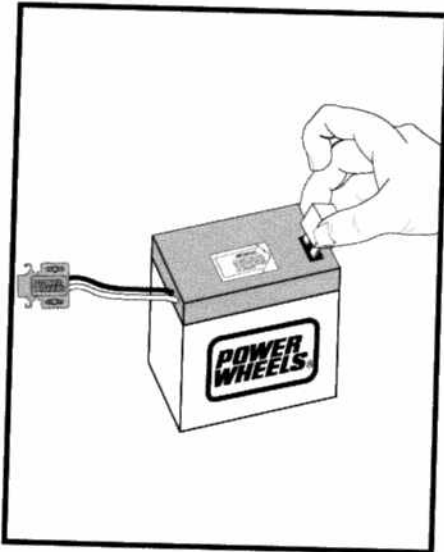

1

INSERT thermal fuse into battery.

YOUR vehicle has the Power Wheels® Lock-In™ connectors.

SQUEEZE tabs on charger and push into battery connectors to lock in. (To disconnect, simply squeeze tabs and pull.)

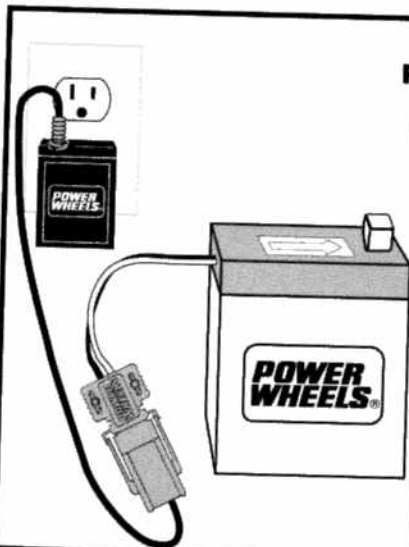

FIRST TIME

18 HRS.

CAUTION

Leaving the battery in a discharged condition will ruin it. The battery must be charged once a month even if the vehicle is not used. Carefully read the battery care instructions in the Owner's Manual to obtain the best battery life.

2

PLUG battery charger into wall outlet.

CHARGE battery for a minimum of 18 hours for the first charge. (After that, 14 hours is enough.) Power Wheels® recommends not charging over 30 hours.

B

DASH ASSEMBLY

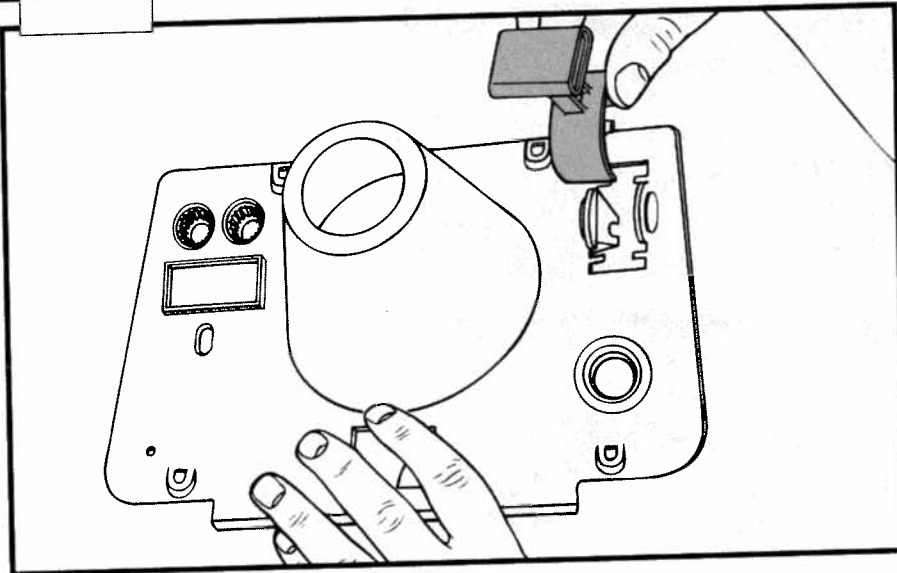

1

SNAP shifter into dash.

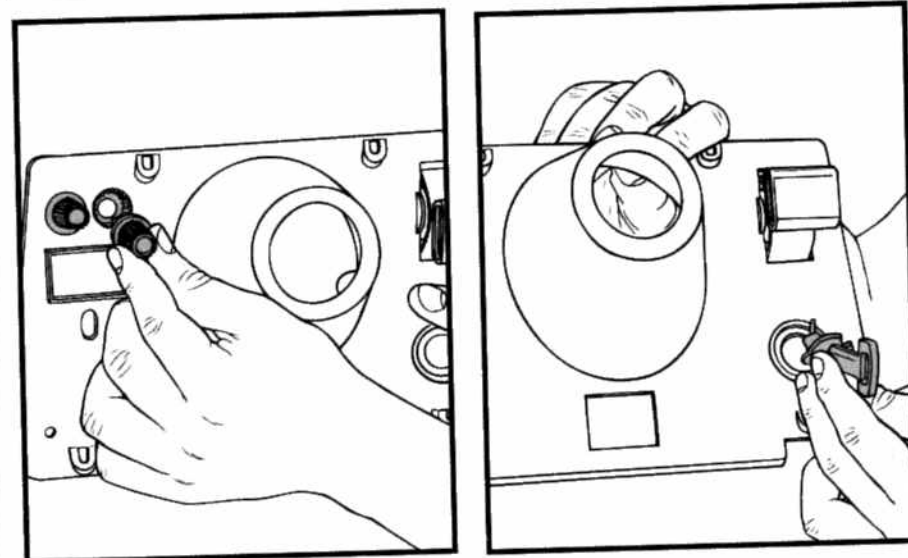

2

SNAP radio knobs into dash.
SNAP key assembly into dash.

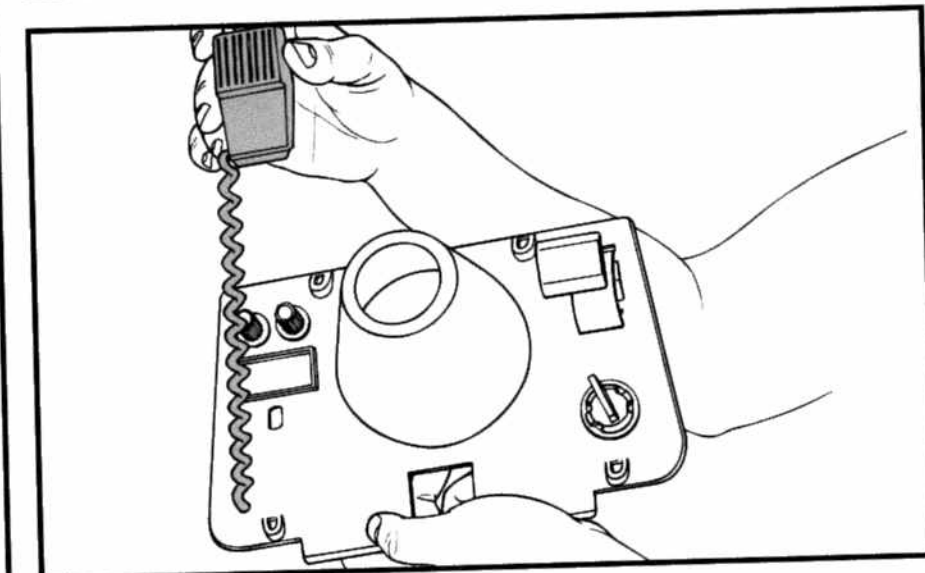

3

SNAP microphone cord into dash.
PLACE microphone in notch in dash.

4

PLACE assembled dash over chassis.
INSERT four 3/4" screws into holes.
TIGHTEN.
Note: Insert bottom two screws first to prevent dash from tipping out of pocket.

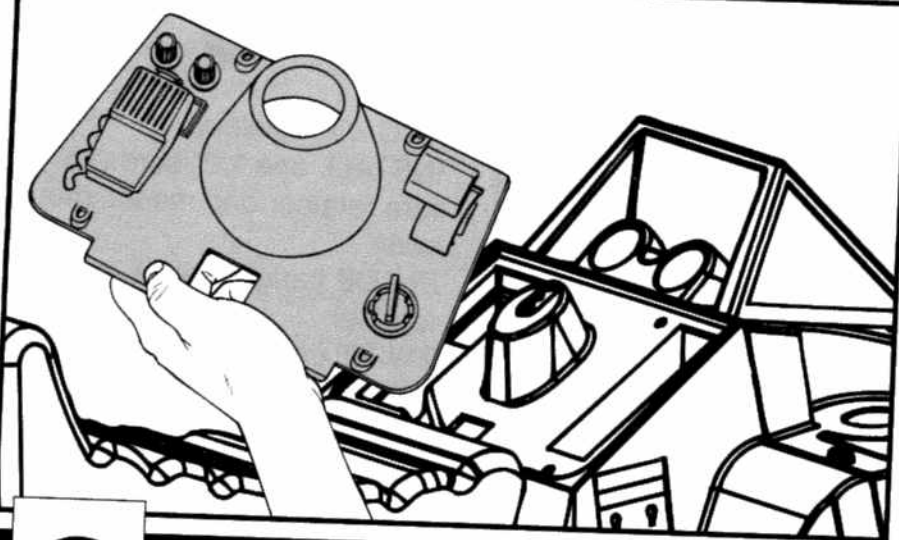

C

STEERING COLUMN / STEERING WHEEL

1

TURN vehicle upside down.
SLIDE steering column through hole in underside of body and through hole in top of body.

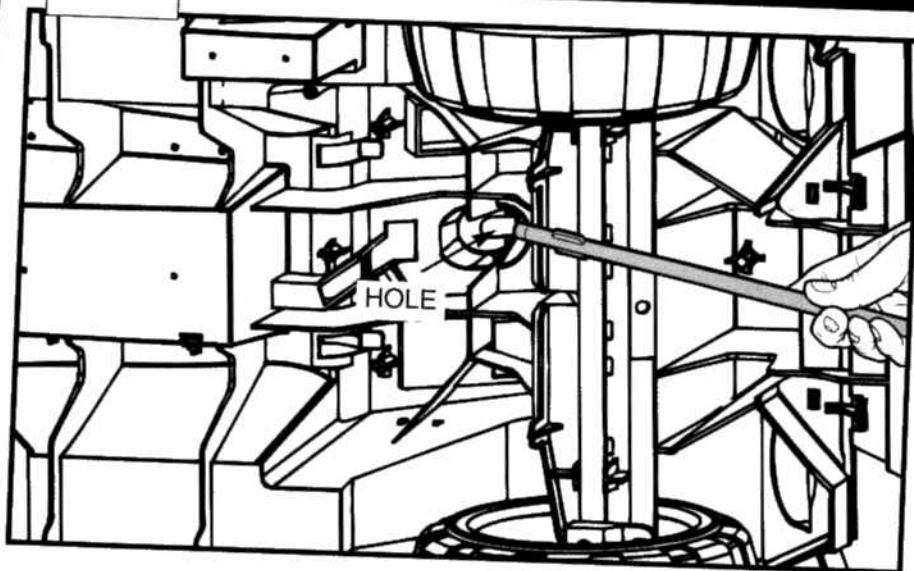

2

INSERT curved end of steering column through hole in steering linkage.

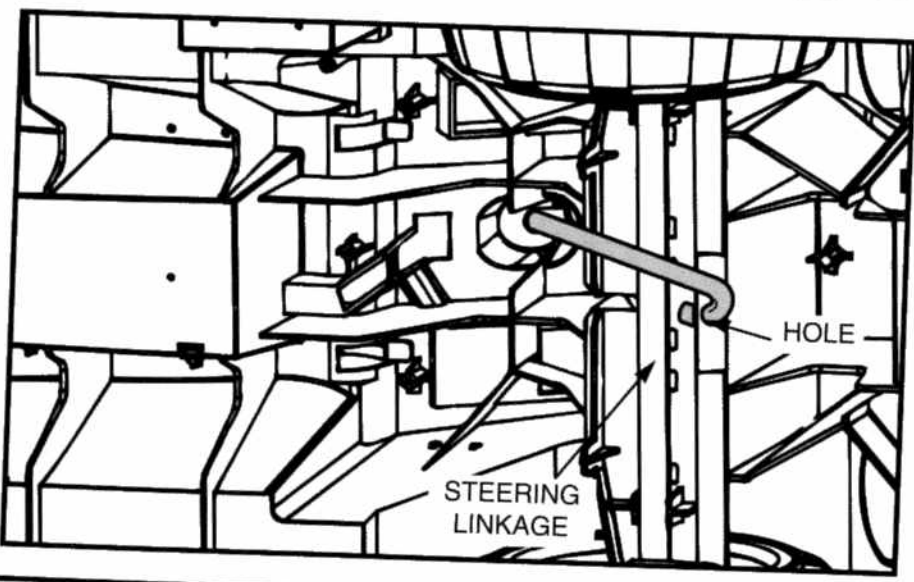

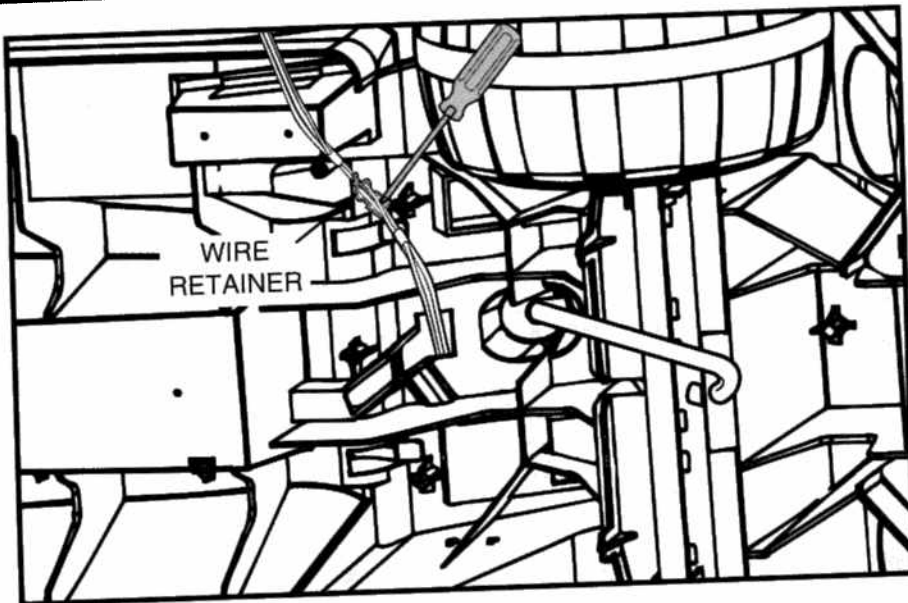

3

ADD wire retainer.
 INSTALL one 1/2" screw in wire retainer and mount into body.
 PLACE hanging wires in wire retainer.
 TWIST ends of wire retainer to hold wires against body.

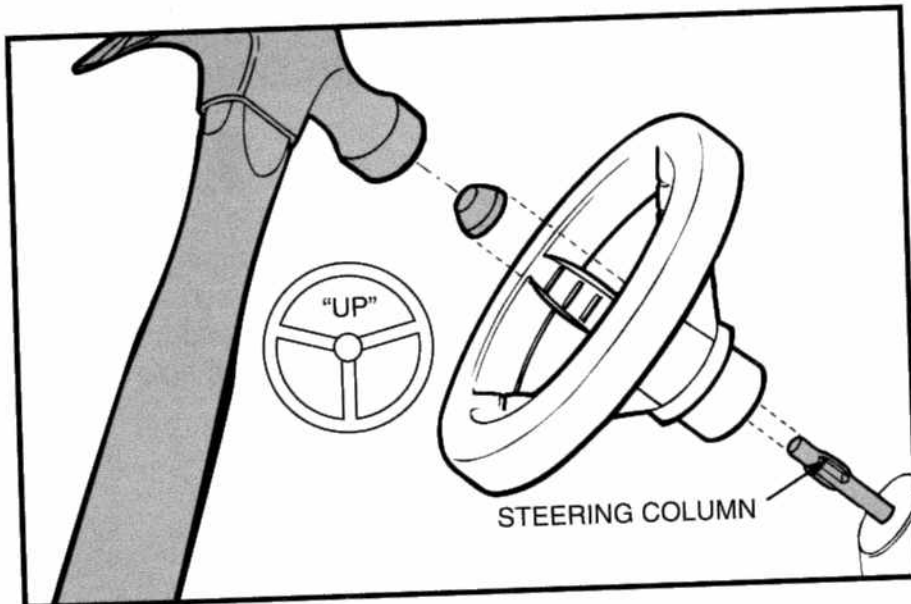

4

SUPPORT curved end of steering column.
 TURN vehicle upright.
 PLACE steering wheel on steering column, right side up.
 HAMMER retainer onto top end of steering column.

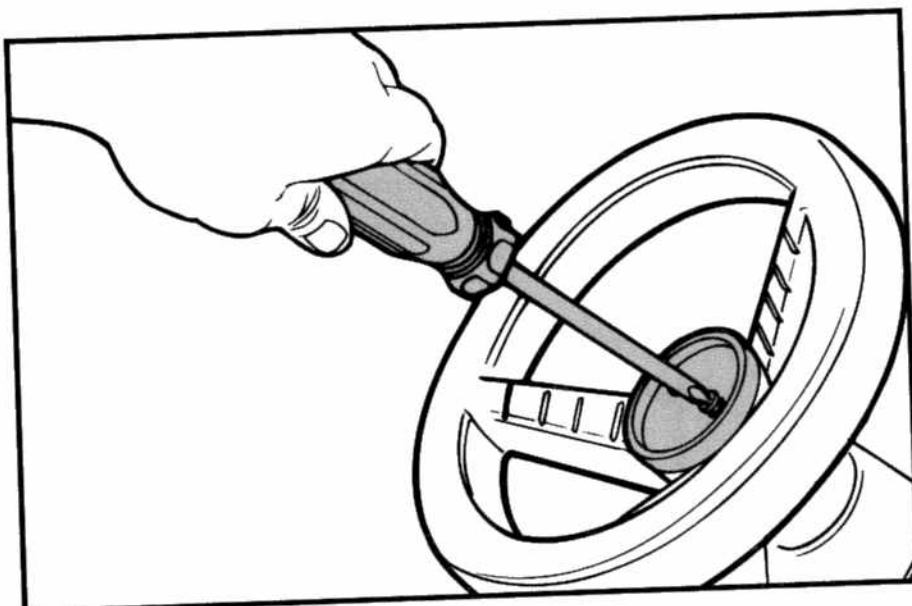

5

PLACE steering wheel plug into steering wheel.
 INSERT two 1" screws into holes.
 TIGHTEN.

D

DUMP BED LATCH

1

PLACE large spring over protrusion on latch handle.

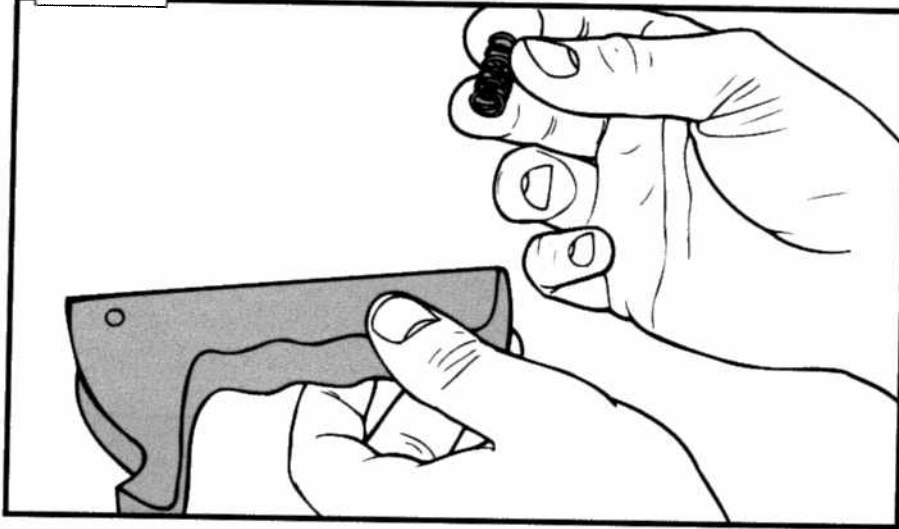

2

ASSEMBLE upper and lower halves of latch release lever.

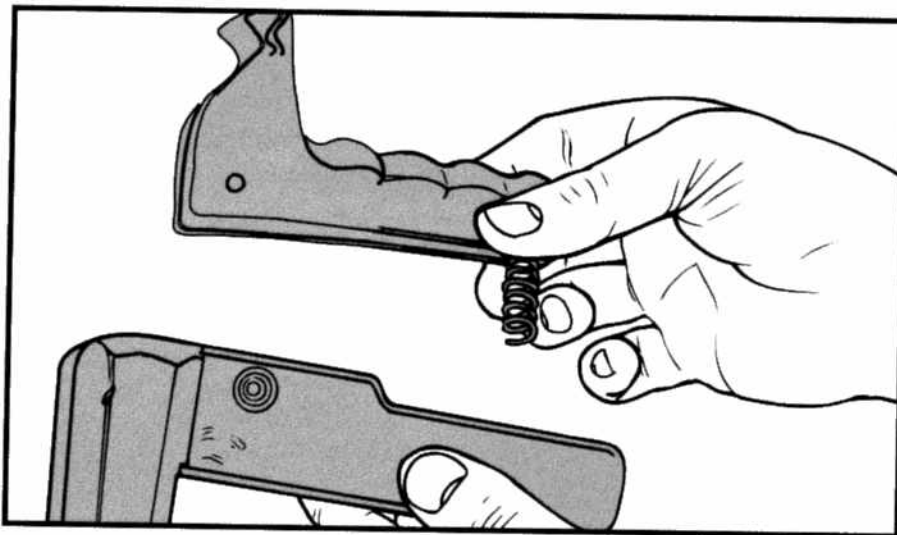

3

INSERT shoulder bolt.
SCREW on acorn nut.
TIGHTEN.

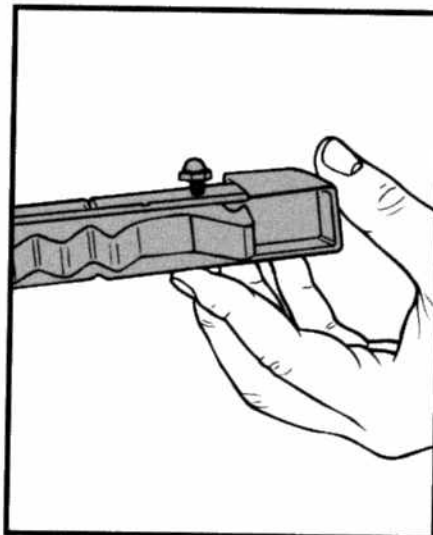
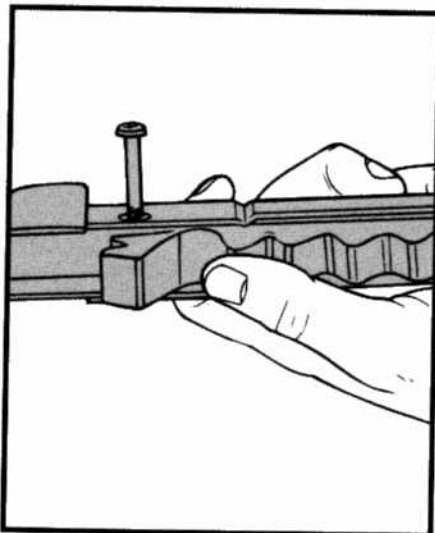

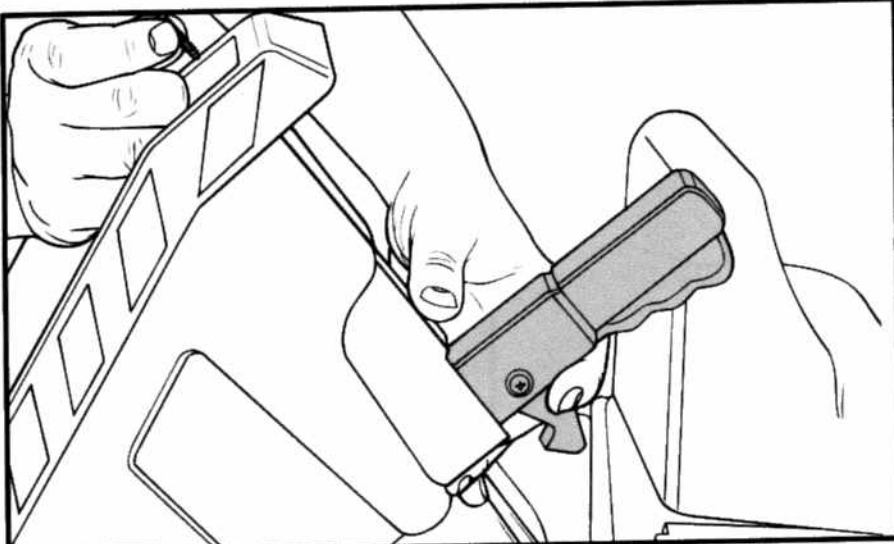

4

SLIDE latch assembly into cavity on underside of dump bed.
INSTALL a 1" black screw into top side of dump bed.
TIGHTEN.

E

DUMP BED INSTALLATION

1

DROP a small spring into each bullet.

2

PLACE bullets onto ends of pivot pin.

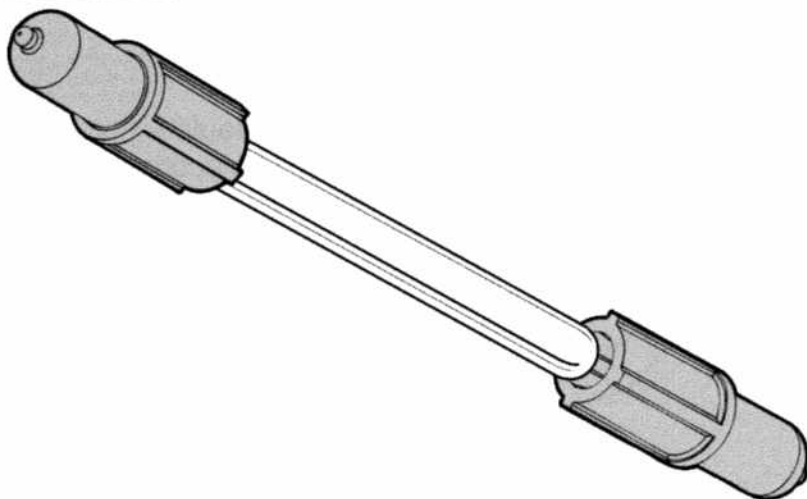
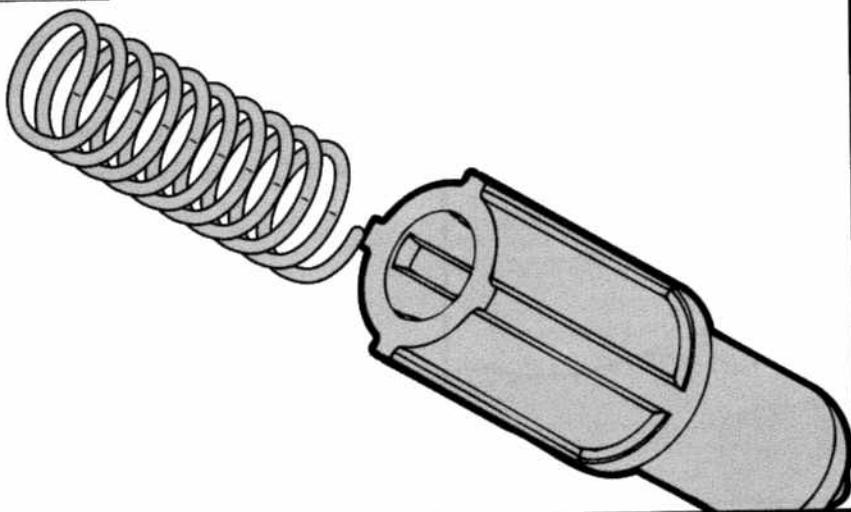

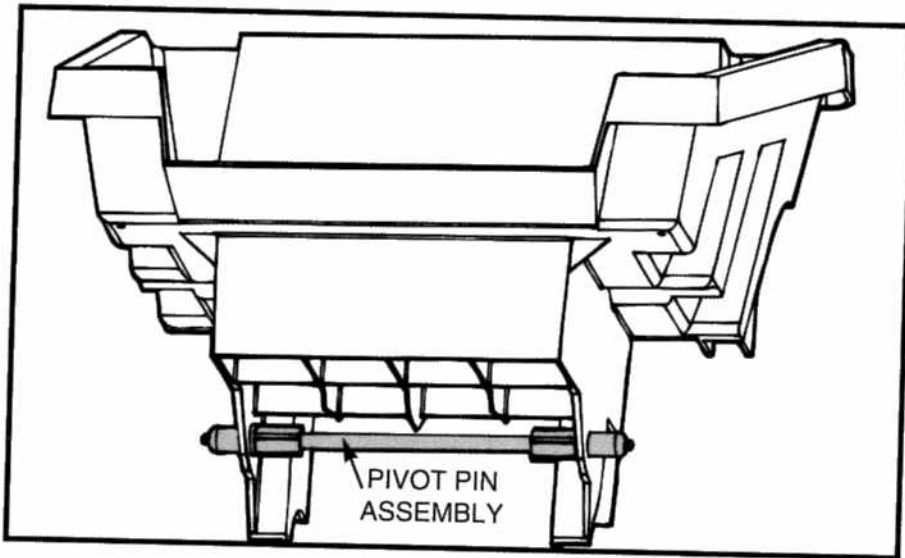

3

SQUEEZE pivot pin assembly to install into underside of dump bed.

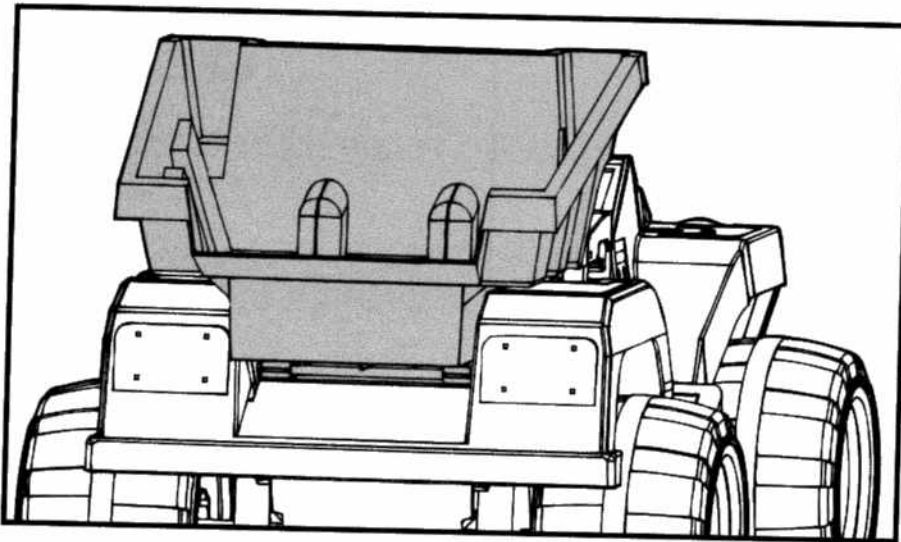

4

SQUEEZE bullets from outside on dump bed. ALIGN with holes in rear of body. RELEASE bullets and snap into body.

F STACK

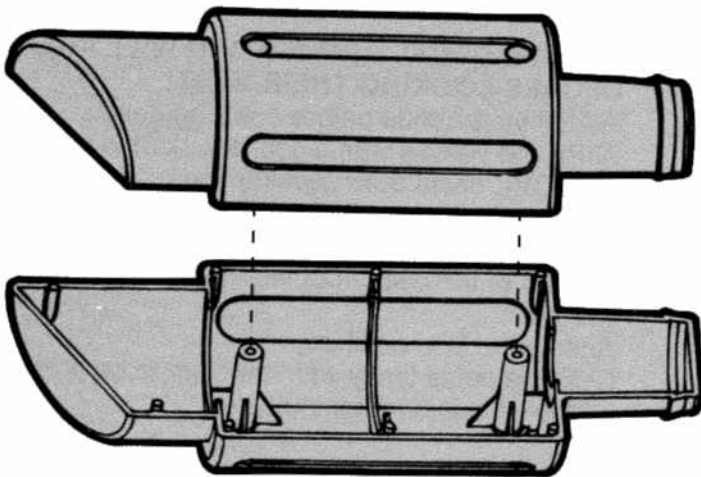

1

ASSEMBLE halves of stack.

2

INSTALL two 1-1/2" black screws into stack.

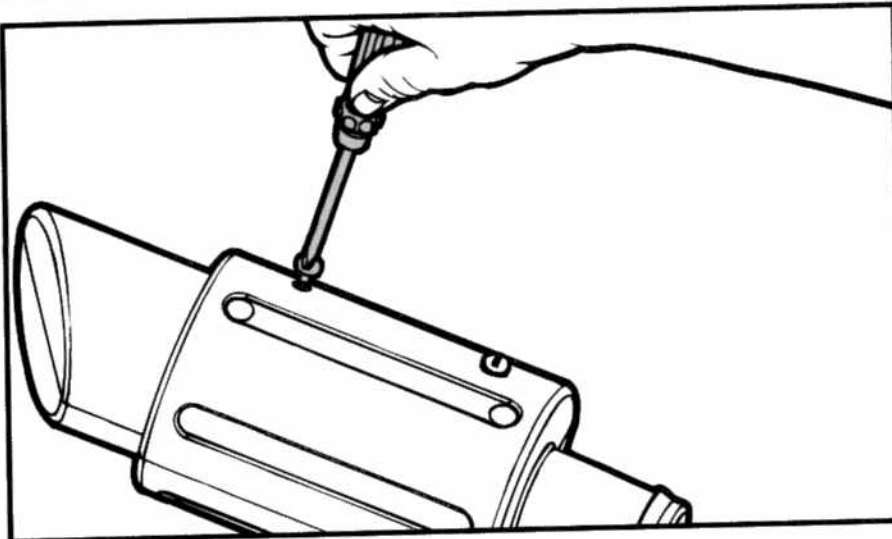

3

PLACE stack into body.

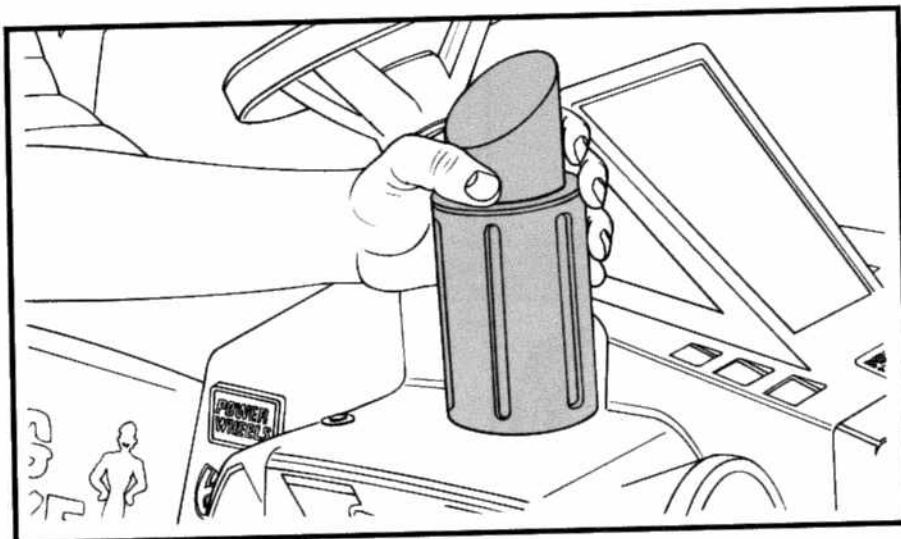

G

DECALS



PROPER DECAL APPLICATION WILL KEEP THE DECALS LOOKING THEIR BEST!

WASH your hands before applying decals.
WIPE the vehicle with a soft **dry** cloth to remove dust.
REMOVE decal from backing sheet.
ALIGN decal in desired position.
LAY down one edge of decal, then slowly lay down the rest of the decal rubbing toward the center as you go.
After decal is in position,
RUB the decal firmly with the cloth to be sure adhesive is in firm contact.

H

LENSES / LIGHTS

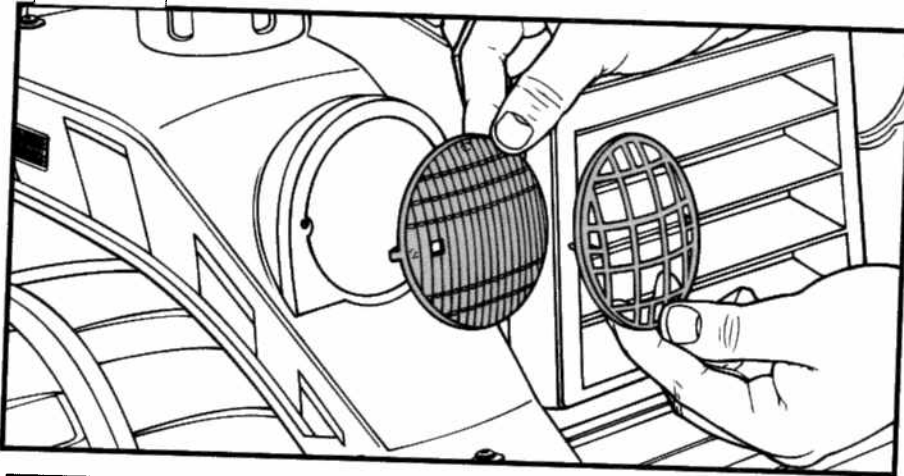

1

(FRONT LENSES)

ALIGN tabs in lenses with body.
SNAP lens set into place.
REPEAT on other side.

2

(REAR LENSES)

APPLY decal.
INSTALL lens guard on each side of back.

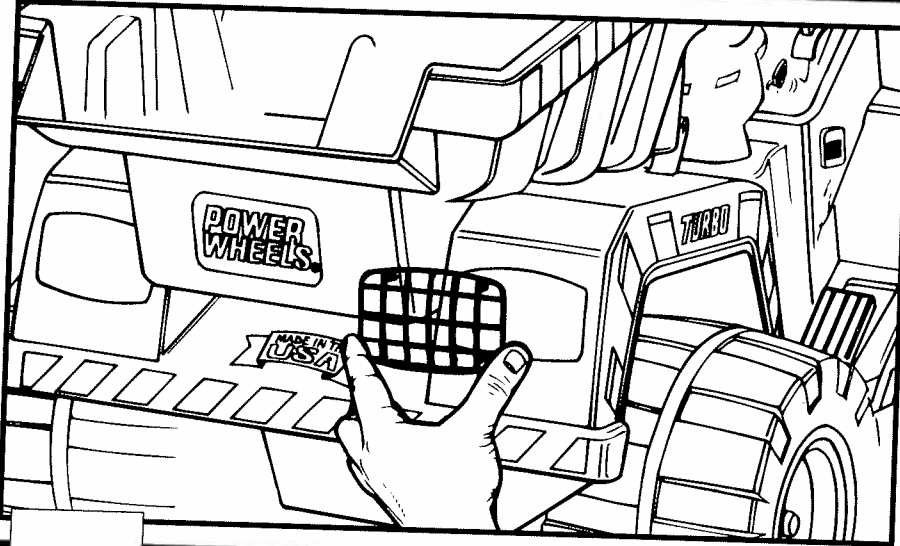

I

BATTERY INSTALLATION

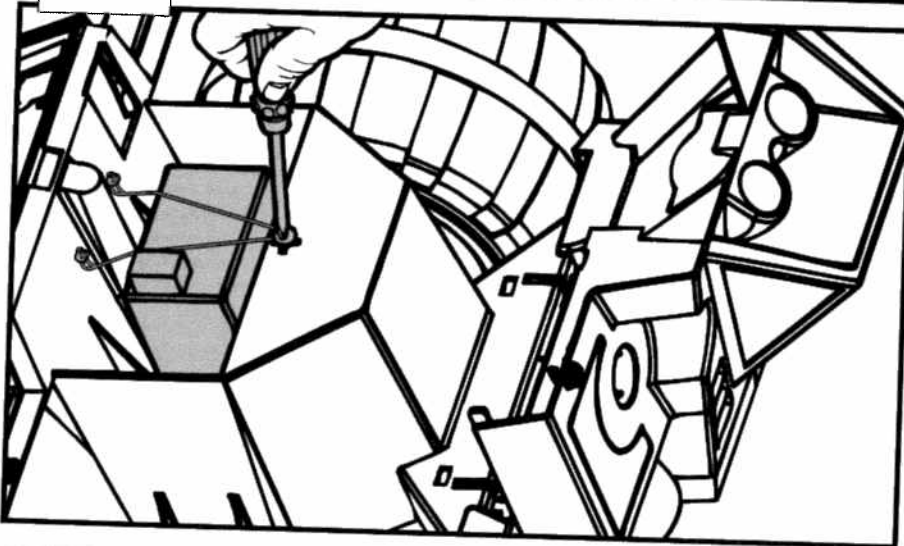

1

OPEN hood.
PLACE battery in compartment.
PLACE battery retainer into slots in body.
INSTALL one 7/8" screw into front of battery retainer.

2

SQUEEZE tabs on motor harness and push into battery connector to lock in.

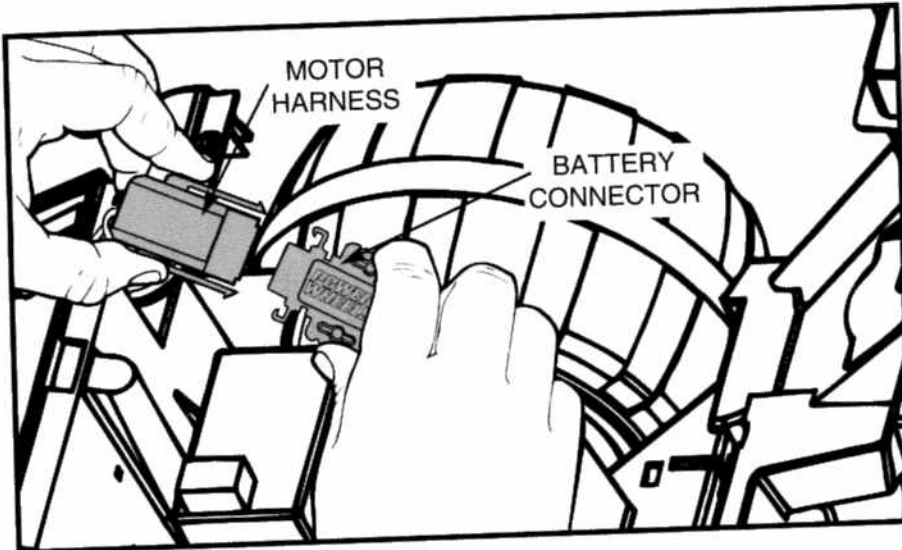

3

CLOSE hood.
TURN hood fasteners 1/4 turn clockwise to lock.

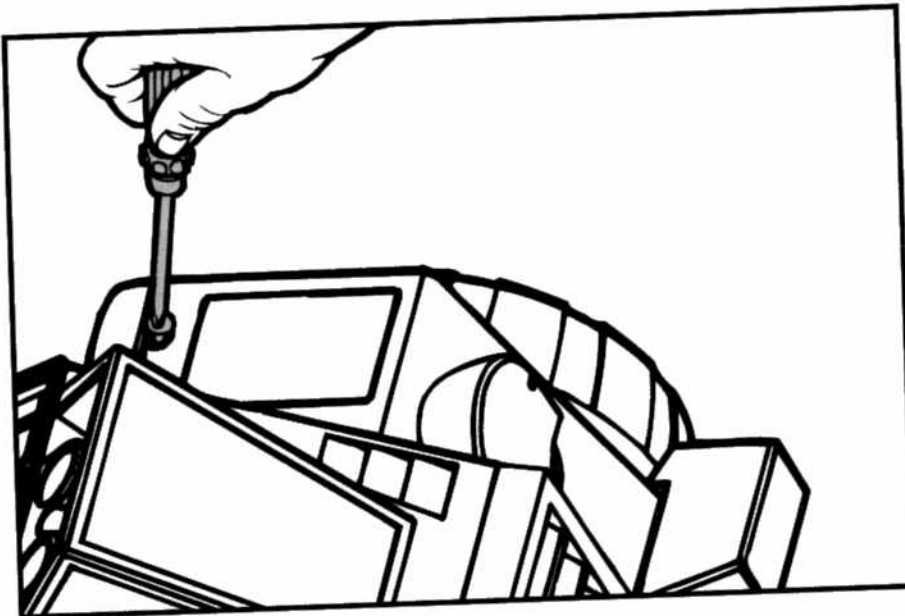

IMPORTANT

Carefully read your Owner's Manual for important safety messages and operating instructions before using your vehicle.

REMEMBER THE FIRST TIME . . .

Charge the battery for a minimum of 18 hours.

AFTER THAT . . .

Charge the battery a minimum of 14 hours.



TRACTION DIFFICULTIES

When a very lightweight child is driving the vehicle, traction may be less than desired on certain surfaces.

To improve traction, we suggest adding approximately 5 pounds to the compartment under the seat. Do not add weight under the dump bed, motor cover, front cab, or other places on the vehicle. Add weight only under the seat. As the child grows, the extra weight can be decreased or eliminated.



If you are still experiencing traction difficulties,
or have other questions, please call toll-free
POWER WHEELS CUSTOMER SERVICE 1-800-348-0751



BIG JAKE™ DUMP TRUCK

FOR MODELS 85700 / 4550 / 74550

Power Wheels
Fort Wayne, Indiana

©1994 FISHER PRICE, INC. – ALL RIGHTS RESERVED
U.S. PATENTS 4,555,451; 4,558,263; 5,051,550 AND U.S. PATENTS PENDING

CAUTION: Electric vehicle not recommended for children under 2 years of age.
As with all electrical products, precautions should be observed during handling and use to prevent electrical shock.



CHARGER: TYPE H INPUT: 120 VAC 60 HZ 15W
OUTPUT: 6.0 VDC 1200 MA

P/N 80037-0295