

Model
78333



imaginext SYSTEM™

Fisher-Price®

www.fisher-price.com

Welcome to the Imaginext™ System

Younger children & those new to the Imaginext™ System

Use our step-by-step instructions to build the structure shown on the cover of this booklet. Encourage your child to assist you with some of the simple steps. This assembly is ideal for active play and it can be used as a playset rather than a building toy.



Older children and experienced Imaginext™ System users

The more your child plays with this toy, and development and skill increases, the less assistance your child needs! Experienced Imaginext™ users will enjoy using all parts of this toy to build their own structures or try building an alternate assembly shown below.



Let's Build It!

1.

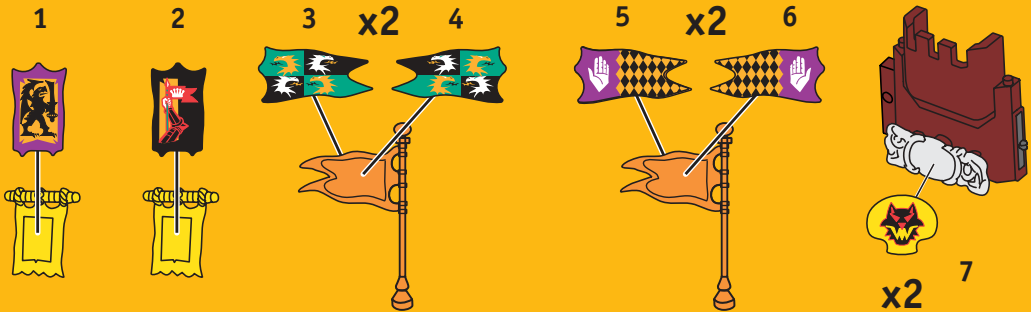

Proper label application will help to keep the labels looking their best! When applying labels, keep the following guidelines in mind:

- Wash your hands before applying the labels.
- Before applying the labels, wipe the surfaces of this toy with a clean, dry cloth to remove any dust or oils.
- Place the labels exactly as shown in the illustrations.
- For best results, avoid repositioning a label once it has been applied.

2.

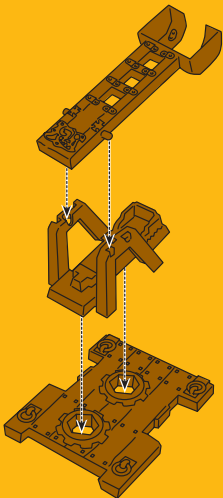

3.

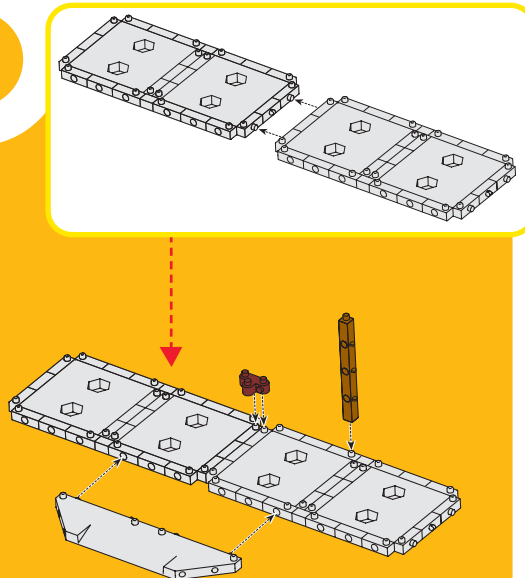

Let's Build It!

4.

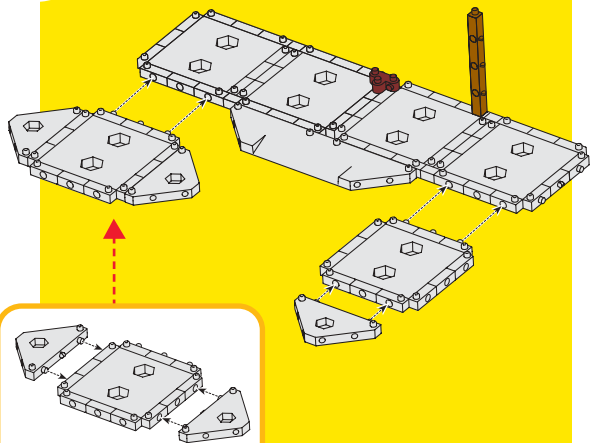

5.

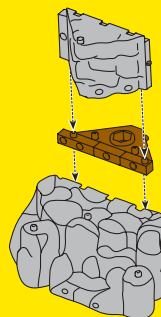

6.

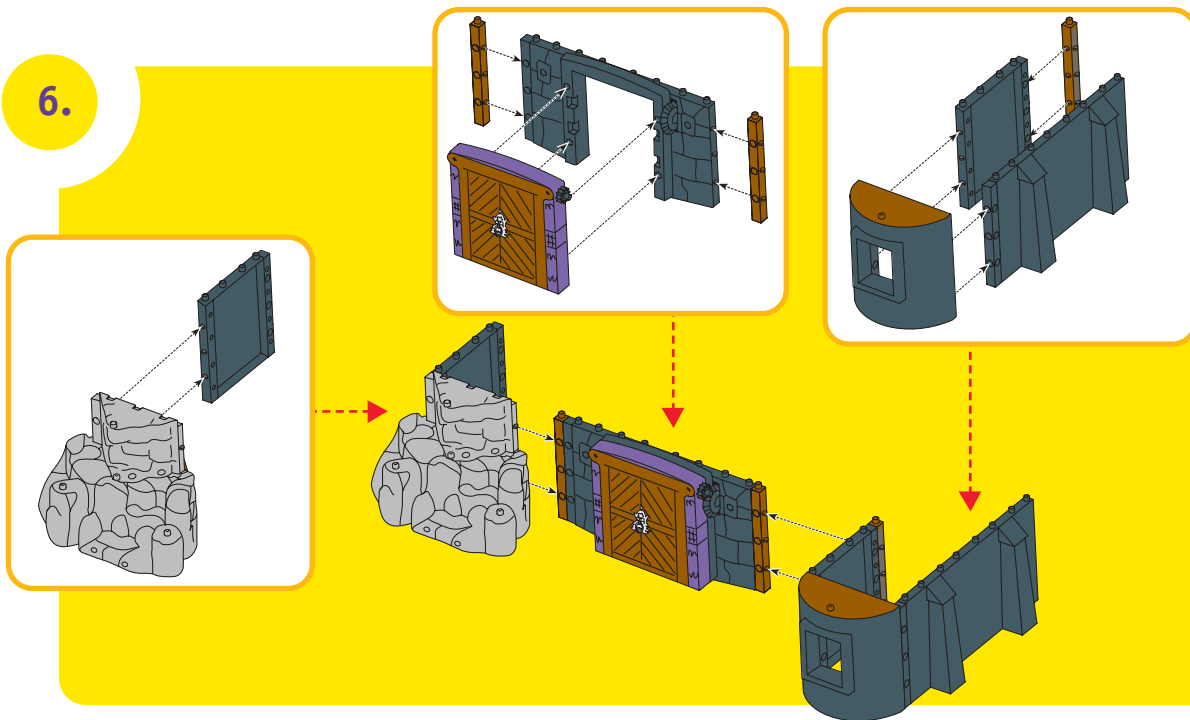

Let's Build It!

7.

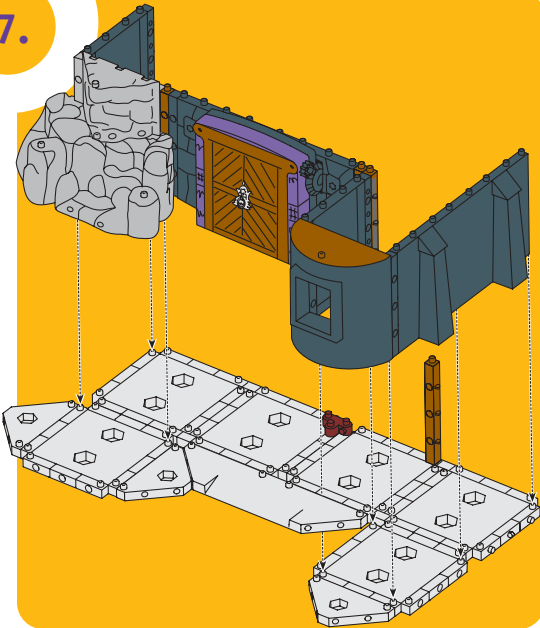

8.

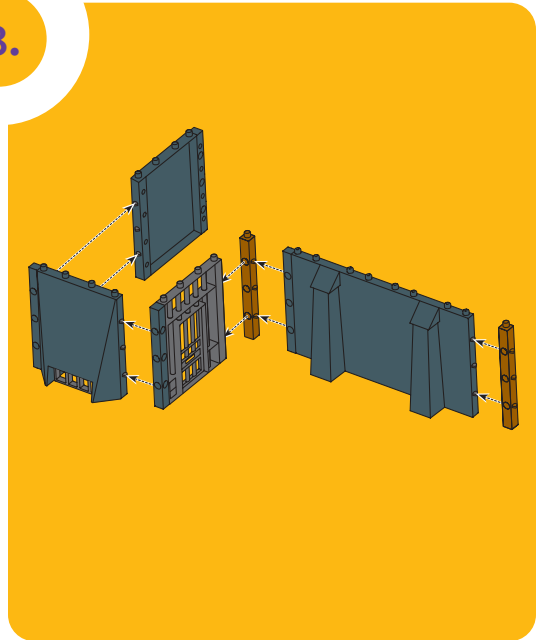

9.

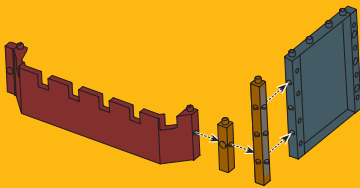

10.

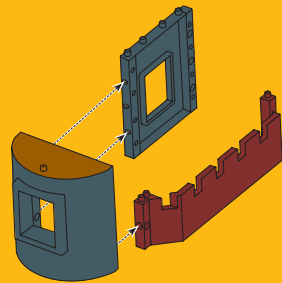

Let's Build It!

11.

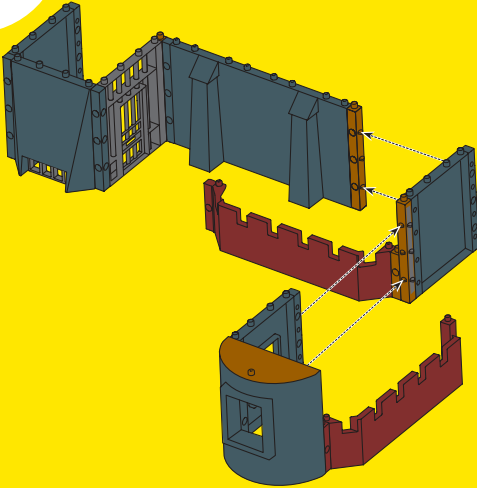

12.

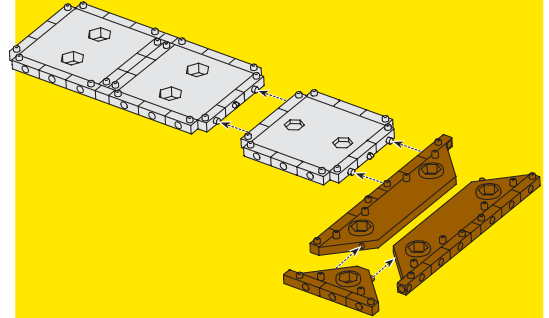

13.

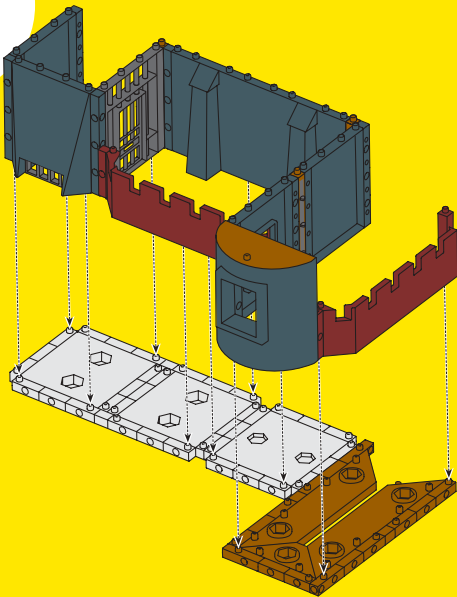

14.

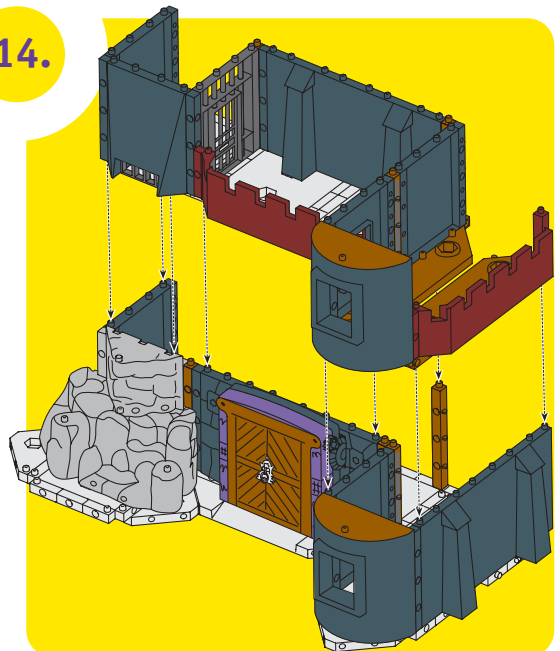

Let's Build It!

15.

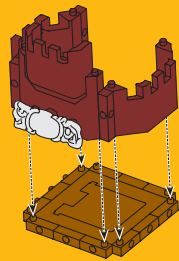
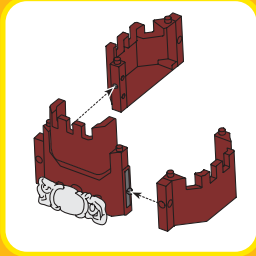

16.

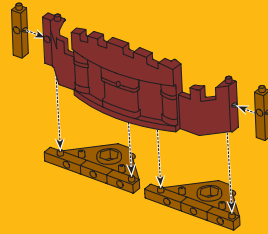

17.

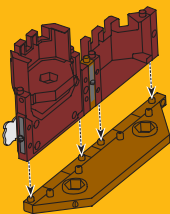
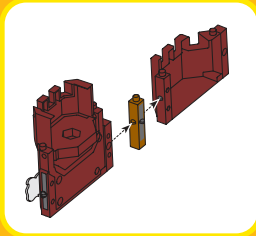

18.

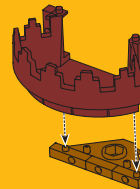

Let's Build It!

19.

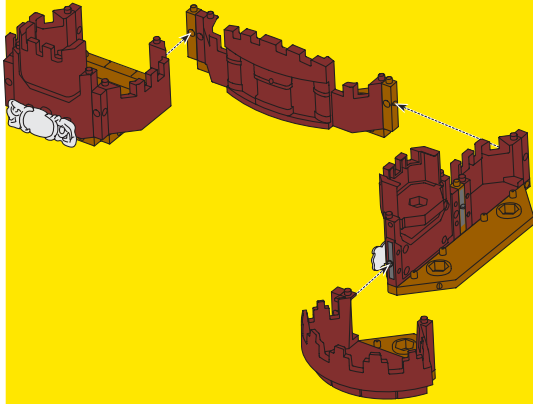

20.

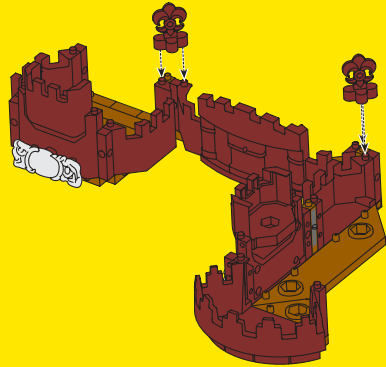

21.

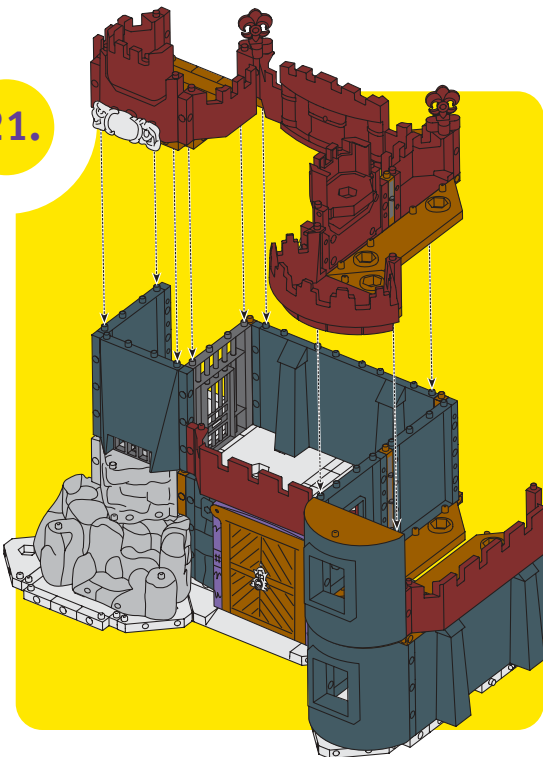

22.

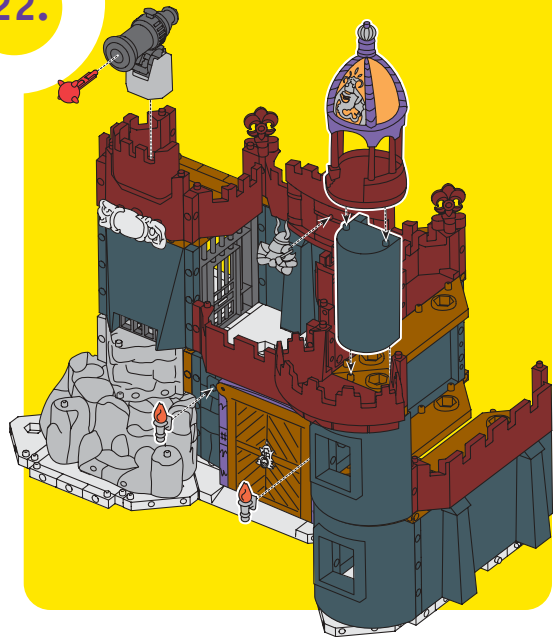

Let's Build It!

23.

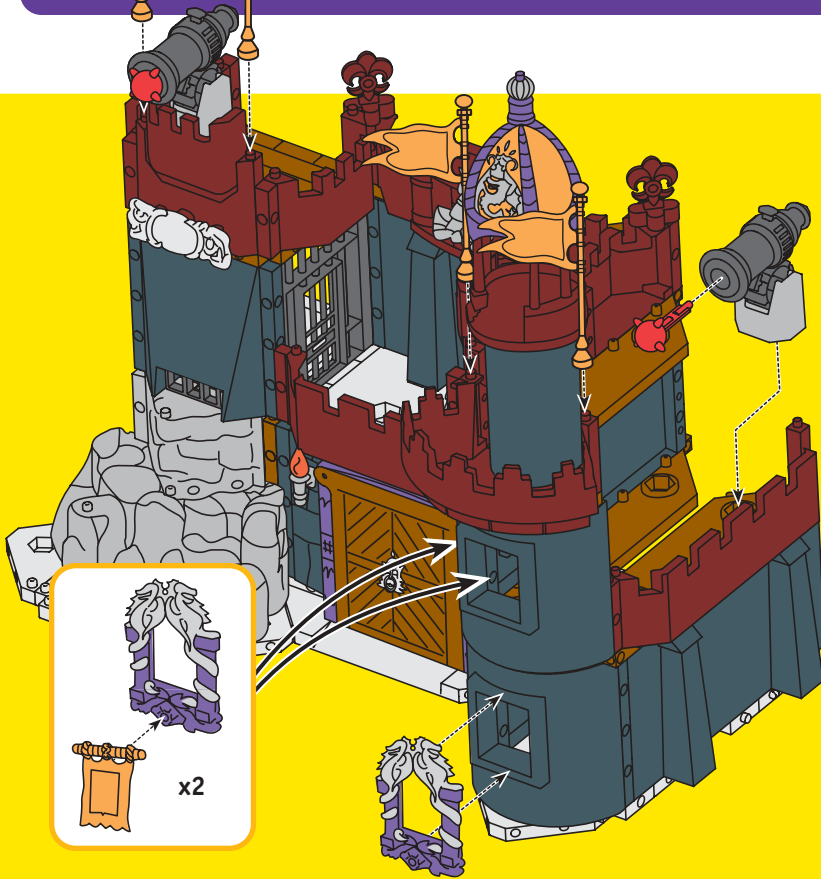

Building System Tips

Here are a few basic tips of the Imaginext System!

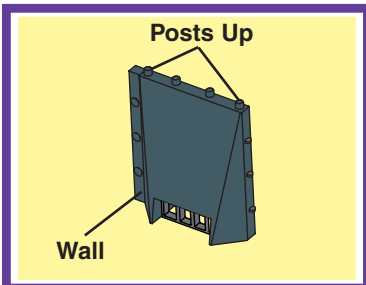

Posts Up: Posts on walls should always face up.

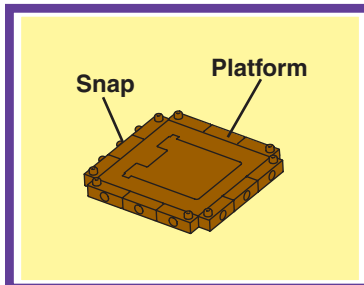

Locate Snaps: Note the locations of the snaps on platforms.

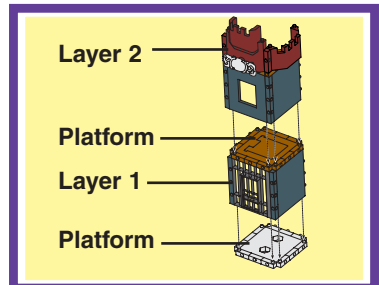

Build Up: Build the bottom layer first, then build additional layers. Use a platform between each layer of your design.

Add to The Excitement!

Combine multiple playsets for an entirely new adventure!



BATTLE CASTLE 78333



LOST FORTRESS 78590



WIZARDS TOWER 78331



ROYAL COACH 78351

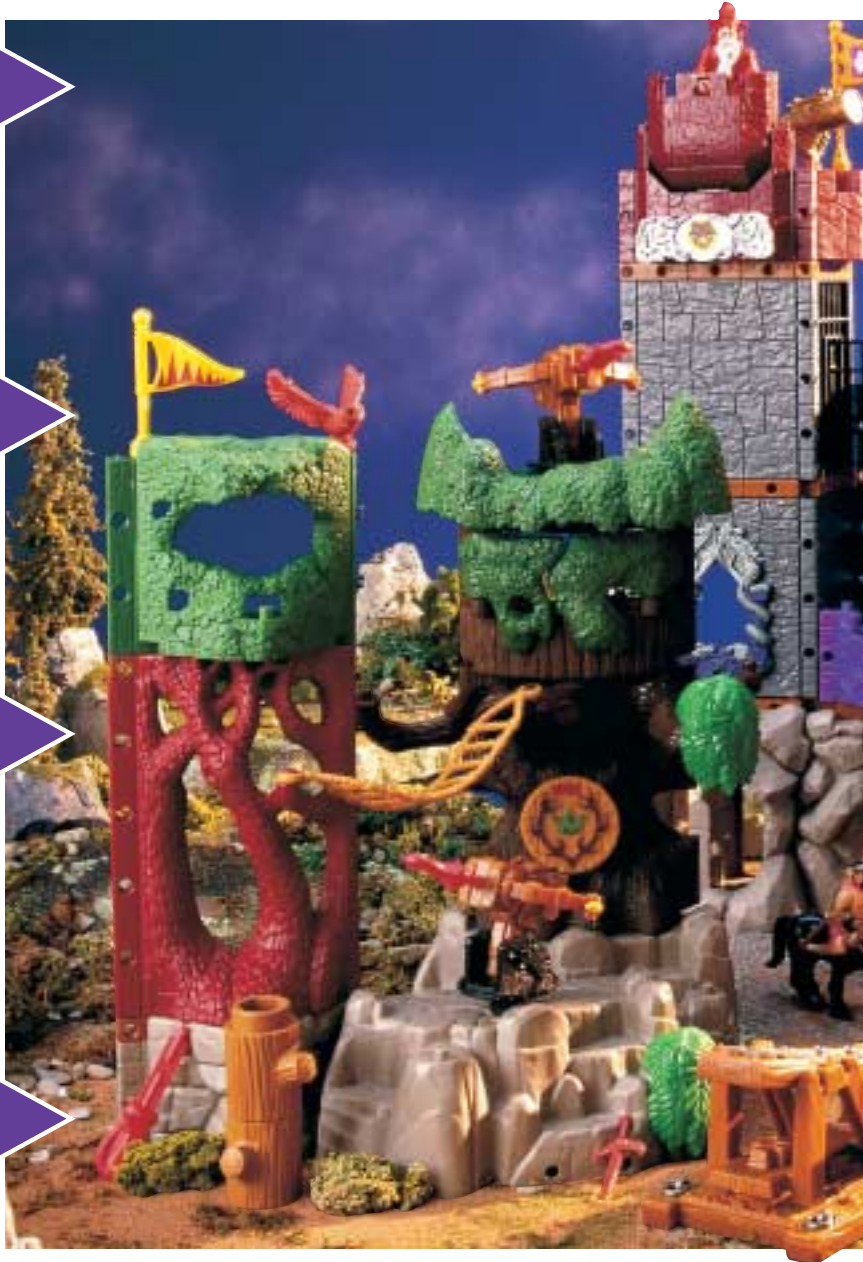





WARNING

Warning – Choking Hazard. Not recommended for children under 3 years because it contains small parts that can be swallowed.

CAUTION

- Do not launch the projectile at close range.
- Only use the projectile supplied with this toy.
- Do not fire at people or animals.

**Please keep this instruction sheet for future reference, as it contains important information.
For children 4-10 years.**

Care

Wipe the toy with a clean cloth dampened with a mild soap and water solution.
Do not immerse the toy.

Questions? We'd like to hear from you!

Call Fisher-Price® Consumer Relations, toll-free at **1-800-432-5437**, 8 AM - 6 PM EST
Monday through Friday. Hearing-impaired consumers using TTY/TDD equipment,
please call 1-800-382-7470. Or, write to:

Fisher-Price® Consumer Relations, 636 Girard Avenue, East Aurora, New York 14052, U.S.A.

For other countries outside the United States: **Canada:** call **1-800-567-7724**, or write to: Mattel Canada Inc.,
6155 Freemont Blvd., Mississauga, Ontario L5R 3W2. **Great Britain:** telephone 01628 500302.
Australia: Mattel Australia Pty. Ltd., 658 Church Street, Locked Bag #870, Richmond, Victoria 3121 Australia.
Consumer Advisory Service 1300 135 312. **New Zealand:** 16-18 William Pickering Drive, Albany 1331, Auckland.
Asia: Mattel East Asia Ltd, Room 1106, South Tower, World Finance Centre, Harbour City, Tsimshatsui, HK, China.