

BIG BAD KONG



OWNER'S MANUAL

Please read thoroughly before operating your vehicle. Keep these instructions for future reference; they contain important information.

CAUTION-ELECTRIC TOY:

NOT RECOMMENDED FOR CHILDREN UNDER 10 YEARS OF AGE. AS WITH ALL ELECTRIC PRODUCTS, PRECAUTIONS SHOULD BE OBSERVED DURING HANDLING AND USE TO PREVENT ELECTRIC SHOCK. INPUT: 120VAC, 60Hz, 15W. OUTPUT: 6.0VDC, 7.2W.

TYCO R/C CONSUMER AFFAIRS



If you have questions or difficulty operating this vehicle, **DO NOT RETURN IT TO THE STORE!** Call Toll-Free 1-888-557-TYCO (1-888-557-8926) for EXPERT technical help and RAPID parts and service assistance. For battery/charger information, call Toll-Free 1-800-348-0751.

CONTENTS

- BIG BAD KONG™ Vehicle
- Power Wheels® 6 Volt Battery (No. 00801-0712)
- Transmitter
- Charger

FEATURES

- Full function
- Range up to 65'/20m
- 27 MHz

VEHICLE

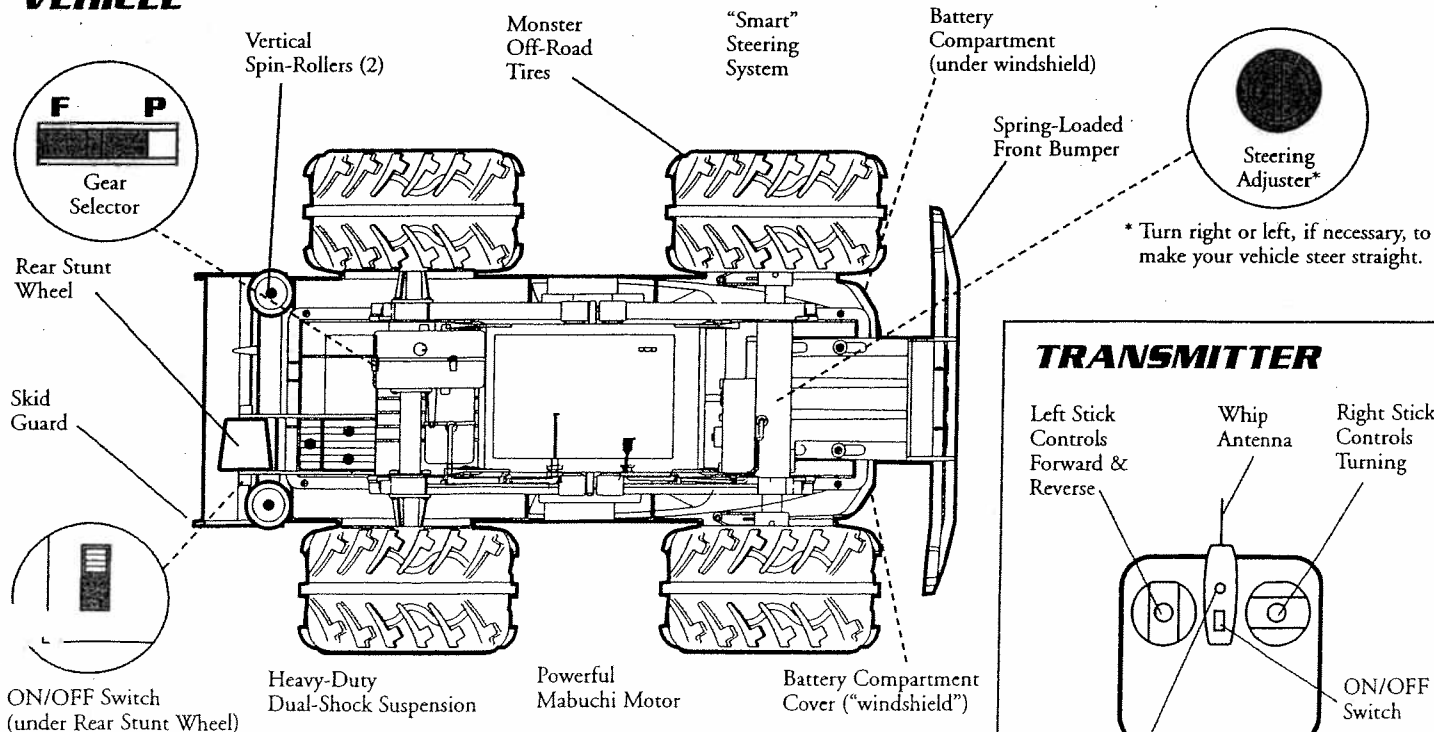

TRANSMITTER

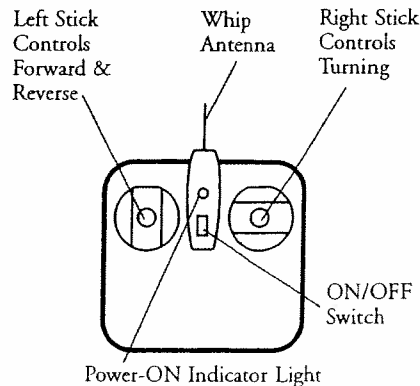

Please read this Owner's Manual thoroughly.

1. Start with a full charge.
2. Turn vehicle switch ON. Turn transmitter switch ON.
When you're done driving, turn vehicle and transmitter switches OFF.

III. OPERATING YOUR VEHICLE

1. BASIC OPERATION

FORWARD

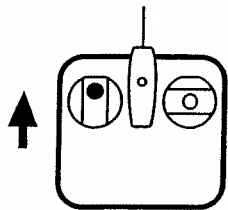

REVERSE

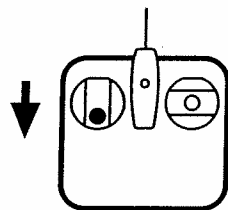

LEFT TURN

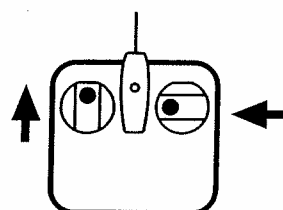

RIGHT TURN

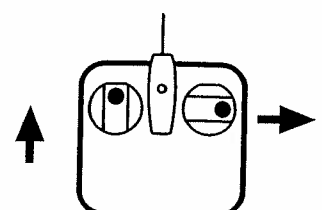

2. COOL BIG BAD KONG™ STUNTS!

For the wildest stunts, start with a full charge.

BRAWLIN', HAULIN' SPEED!

Put the gear selector into FAST mode ("F"). Now jam the left control stick all the way up and keep it there for rippin' speed — on or off-road! For EXTREME off-road conditions, put the gear selector into POWER mode ("P") — for maximum torque!



GIANT JAMMIN' WHEELIES!

Put the gear selector into POWER mode ("P"). Push the left stick down to drive in reverse. Once you've accelerated to full speed, quickly push the left stick up: your vehicle will rear back into an awesome wheelie! Keep the left stick all the way up to keep driving in wheelie mode. When your vehicle drops back onto all four wheels, the heavy-duty suspension will soak up the impact.

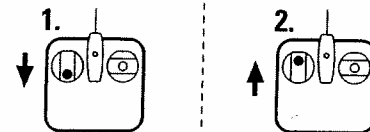
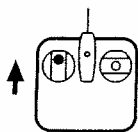
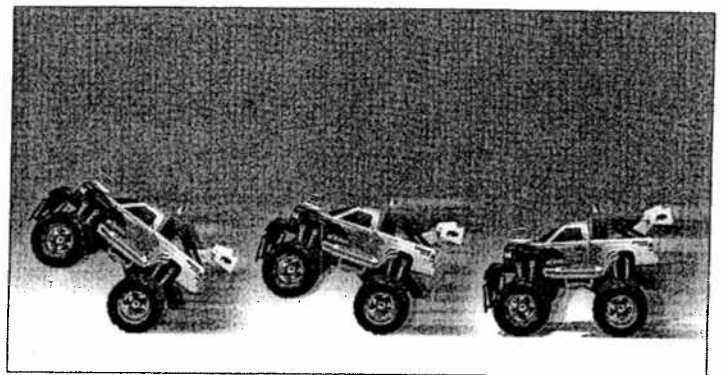

 Do this stunt with the gear selector in POWER mode ("P") ONLY! Using FAST mode ("F") may make your vehicle unstable.

VERTICAL TAILSPINS!

Put the gear selector into POWER mode ("P"). Push the left stick down to drive in reverse. Once you've accelerated to full speed, quickly push the left stick up to go into wheelie mode. Now give the left stick another quick upward push. Your vehicle will rock back onto the Vertical Spin-Rollers. Keep the left stick all the way up for an amazing vertical 360° spin!

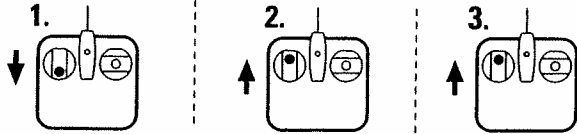

 Do this stunt with the gear selector in POWER mode ("P") ONLY! Using FAST mode ("F") may make your vehicle unstable.



IV. SCREAMIN' TECHNOLOGY™

Your BIG BAD KONG™ vehicle includes many advanced engineering features for ultra-high performance and safety.

1. PERFORMANCE FEATURES

SPECIAL SPEED & STUNT FEATURES

This isn't just a "monster truck" body and a set of giant tires! The Big Bad Kong vehicle is designed for ultra-high speed, extreme off-road driving...AND awesome stunts! See Section III, 2 for detailed stunt information.

"SMART" STEERING & DYNAMIC BRAKING

Unlike many R/C vehicles, the Big Bad Kong vehicle uses an advanced power-steering system. This system actually senses the front wheels' position and steers them straight when the right control stick is released. When it's time to stop, the Big Bad Kong vehicle doesn't just coast to a stop. For added performance and safety, the vehicle actually uses motor power to bring it to a quick, secure stop.

DUAL-SHOCK SUSPENSION

To handle the weight and power of this vehicle, we've designed a special heavy-duty dual-shock-absorber suspension system. These super-tough springs – together with a set of honkin' all-terrain tires – give it amazing off-road driving power!

2. SAFETY SYSTEMS

SPRING-LOADED FRONT BUMPER

Your vehicle features a specially-designed spring-loaded front bumper that "gives" on impact. This feature protects people, walls and the vehicle itself. Please read and follow all of the safety cautions in this Owner's Manual.

"SMART" SENSOR

A special sensor prevents the vehicle from operating if it senses a heavy object trying to "ride" the vehicle. The sensor works by detecting excessive compression of the suspension springs. It's a "smart" sensor that won't cut power if the springs compress just for a second during hard off-road driving.

EASY-CARRY SYSTEM

We've engineered this vehicle to make it safe and easy to carry. There are three "handle" points on the vehicle: (a) the front bumper; (b) the "light bar"; (c) the Rear Stunt Wheel. You can safely carry your vehicle by any two of these points. Please don't try to carry it by just one of them, though: this is a big, heavy vehicle! And be sure to ask for help carrying the vehicle if you need it!

HIGH-SECURITY BATTERY COMPARTMENT

To ensure the security of the high-capacity battery that powers your vehicle, we've designed a special battery compartment. You'll need a Philips screwdriver to open and close the compartment...and to secure the special shield that locks the battery in place. Be sure you NEVER operate your vehicle without the battery properly secured!

THERMAL FUSE

The Power Wheels® battery in your vehicle is equipped with a built-in, self-resetting thermal fuse. The thermal fuse is a safety device which automatically "trips" and shuts down the vehicle temporarily if the driving conditions are too severe. Once a fuse has "tripped," it will automatically reset itself after approximately 25 seconds and allow the vehicle to resume normal operation. To avoid repeated automatic shut-downs, avoid severe driving conditions (such as driving up very steep hills or running into fixed objects) which can cause the wheels to stop spinning while power is still being supplied to the motor. If a thermal fuse continually trips, please contact your local Power Wheels® authorized service center. For the location of the nearest such center, please call 1-800-348-0751.

V. QUICK TIPS

1. When your vehicle starts to lose power, it may lose functions or performance. It's time for fresh batteries (or a recharge). Your vehicle's running time may change depending on your driving style.
Radio interference can make your vehicle run badly. Interference can be caused by other R/C vehicles running on the same frequency; electrical wires; large buildings; or CB radios. Try to stay away from these!
3. Point your transmitter antenna up - not down toward your vehicle. If your vehicle gets too far away, it won't work properly.
4. Don't drive your vehicle in sand or through water or snow. If your vehicle does get wet, wipe with a towel and allow to dry completely.
5. Don't store your vehicle near heat or in direct sunlight. Always turn switches OFF for storage.

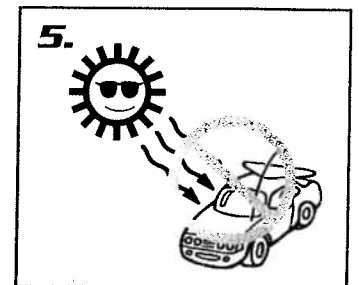
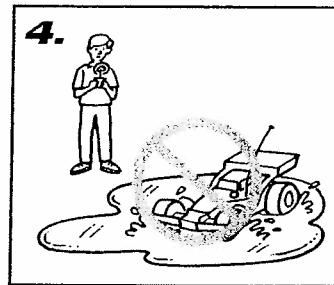
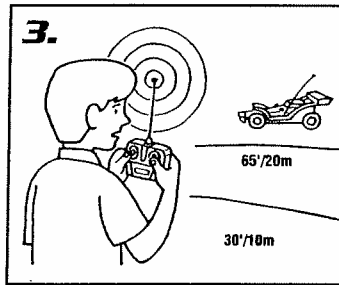
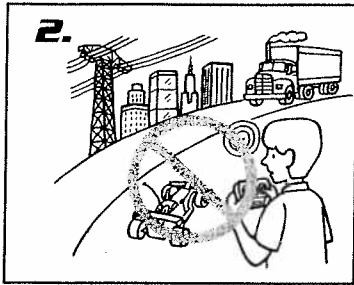
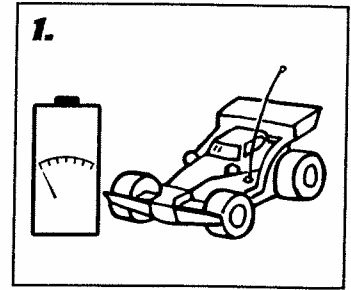

VI. BATTERY INSTALLATION

1. VEHICLE

You'll need a Philips screwdriver to get started. Please ask an adult to help with battery installation.

NEVER operate your vehicle without the battery properly secured!

1. Give your battery a full charge (see Section VII).
2. Make sure vehicle and transmitter switches are turned OFF. Carefully unscrew the 2 screws that secure the battery compartment cover ("windshield"). Lift off the battery compartment cover.
3. Unscrew the 2 screws that hold the battery shield. Carefully lift off the shield. Place the battery in the compartment and slide it all the way back. Replace the shield and tighten the screws. Plug the wire connectors from the battery into the battery compartment socket as shown (make sure the connection is secure).
4. Replace the battery compartment cover ("windshield") and tighten the screws.



Battery Shield



2. TRANSMITTER

1. Install one 9-volt battery with polarity (+/-) as shown inside battery compartment.
2. The transmitter battery will last much longer than the run time of the rechargeable vehicle battery.

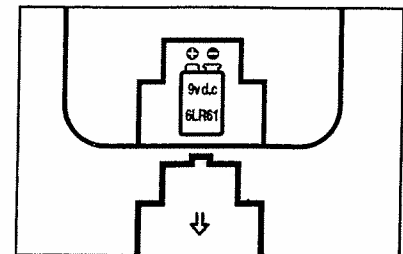

Estimated run time for this vehicle: 45 minutes

VII. BATTERY CHARGING

- Use only Power Wheels® 6V Battery No. 00801-0712.
- We recommend that you charge your battery in the vehicle.
- **THE BATTERY MUST BE UPRIGHT WHILE CHARGING.**

1. Plug the charger and battery connectors together.



If you are recharging your battery, you will first need to disconnect the battery connector from the vehicle's battery compartment socket.

2. Plug the charger into a standard wall outlet.



If power flow to the wall outlet is controlled by a switch, make sure the switch is **ON**.

3. Before first-time use, charge the battery for at least 18 hours. **NEVER** charge the battery longer than 30 hours.

4. Recharge the battery for at least 14 hours after each use of your vehicle. Do not charge the battery longer than 30 hours.

5. Once the battery is charged, disconnect the charger connector from the battery connector. Unplug the charger from the wall outlet. The battery is now ready to be installed in your vehicle. If your battery is already installed in your vehicle, simply re-connect the battery connector to the vehicle's battery compartment socket and replace the battery compartment cover (see Section VI).

6. Recharge the battery after each use.

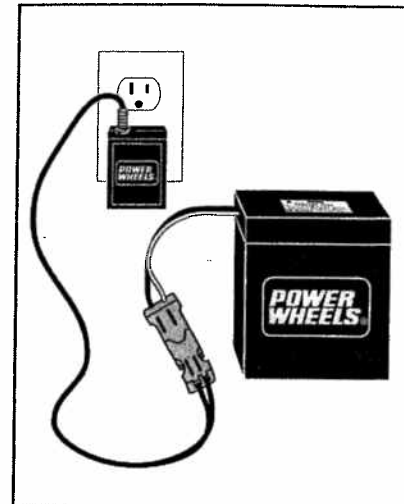

VIII. CAUTIONS

Adults, this toy is recommended for children 10 years of age and older. To ensure that the child's play is both safe and fun, please review the operating instructions and ALL SAFETY PRECAUTIONS AND INSTRUCTIONS with the child.

I. BATTERY SAFETY CAUTIONS

WARNINGS

- The battery and charger must be handled and operated by adults only. Adult supervision is recommended **AT ALL TIMES** during operation of this toy. The battery is heavy and contains sulfuric acid (electrolyte). Dropping the battery could result in serious injury.
- Never allow children to charge the battery. Battery charging must be done by adults only. A child could be injured by the electricity involved in charging the battery.
- Use of the wrong type battery or charger could cause a fire or explosion, resulting in serious injury.
- Read the cautions on the back panel of the battery.
- Never pull, lift or carry the battery by the wires or connector. This can damage the battery and possibly cause a fire resulting in injury. Lift and carry the battery by the case only.
- Examine the battery, charger and their connectors for excessive wear or damage each time you charge the battery. If damage or excessive wear is detected, do not use the charger, the battery or the vehicle until you have replaced the worn or damaged part, as it could possibly cause a fire resulting in injury.
- Never alter your vehicle or its electrical system in any way. Alterations could cause a fire resulting in injury and could also ruin the electrical system.
- Use the charger in dry locations only.

Please Note:

- Your new battery must be charged for at least 18 hours before you use it in your vehicle for the first time. **NEVER** charge the battery longer than 30 hours.
- Before charging a battery, examine the battery for cracks and other damage which may cause sulfuric acid (electrolyte) to leak during the charging process. If damage is detected, do not charge the battery or use it in your vehicle. Battery acid is very corrosive and can cause severe damage to surfaces it contacts.
- **The battery must be upright while charging. We recommend that you charge your battery in the vehicle.**
- This toy is not intended for children under 3 years old. The charger is not a toy.
- Do not short-circuit the supply terminals.
- Do not charge the battery on a surface which could be damaged by the acid contained in the battery. Take precautions to protect the surface on which you charge the battery.
- Use only a Power Wheels® 6 volt charger (INPUT: 120VAC, 60 Hz, 15W; OUTPUT: 6.0VDC, 7.2W) to charge your Power Wheels® 6 volt battery.

BATTERY CARE

- If a battery leak develops, avoid contact with the leaking acid and place the damaged battery in a plastic bag. See information below for proper disposal.
- If acid comes in contact with skin or eyes, flush with cool water for at least 15 minutes and call a physician. If acid is internally ingested, give water, milk of magnesia or egg whites immediately. Never give emetics or induce vomiting. Call a physician.
- Charge a new battery for at least 18 hours before first use. Never charge the battery longer than 30 hours. Overcharging or undercharging the battery may shorten battery life and decrease vehicle running time.
- After the first charge, recharge the battery for at least 14 hours after each use. NEVER charge the battery longer than 30 hours. Recharge the battery after each use, regardless of how long the vehicle was used.
- The battery must be upright while charging.
- Do not allow the battery to run down completely before charging.
- Charge the battery before storing the vehicle.
- Charge the battery at least once per month, even if the vehicle has not been used.
- Leaving the battery in a discharged condition will ruin it.
- Always remove an exhausted battery from the vehicle. Battery leakage and corrosion can damage the vehicle.
- Do not store the battery in temperatures above 75° F or below -10° F.
- Prevent the battery from moving freely inside the battery compartment. Always use the battery shield to secure the battery in the battery compartment.
- Examine the battery, charger and their connectors for excessive wear or damage each time you charge the battery. If damage is detected, do not use the charger, the battery or the vehicle until you have replaced the worn or damaged part.



CONTAINS SEALED LEAD BATTERY. BATTERY MUST BE RECYCLED. FOR FURTHER INFORMATION IN THE UNITED STATES REGARDING BATTERIES OR THEIR DISPOSAL PLEASE CALL 1-800-348-0751.

BATTERY DISPOSAL

- Your Power Wheels® battery is a sealed lead-acid battery. It must be recycled or disposed of in an environmentally sound manner.
- Do not dispose of a lead-acid battery in your regular, household trash. The incineration, landfilling or mixing of sealed lead-acid batteries with household trash is prohibited by law in most areas.
- Return the battery to a federal or state approved lead-acid battery recycler, such as a Power Wheels® authorized service center, or a local seller of automotive batteries. In Minnesota, call 1-800-348-0751 if further disposal information is required. Contact your local waste management officials for other information regarding the environmentally sound collection, recycling and disposal of lead-acid batteries.

IMPORTANT BATTERY INFORMATION

- Insure that battery polarity is correct.
- Use only batteries of the type recommended.
- Do not mix old and new batteries.
- Do not mix alkaline, standard (carbon-zinc), or rechargeable (nickel-cadmium) batteries.
- Remove used-up batteries immediately. Remove batteries if vehicle will not be used for a long period.
- For best performance use alkaline batteries (where disposable batteries are called for). Battery life may vary depending on battery brand.
- Do not recharge non-rechargeable batteries.
- Do not short-circuit terminals.
- Battery charging must be done by adults only.
- Dispose of batteries safely.

2. VEHICLE SAFETY CAUTIONS

Adults, this toy is recommended for children 10 years of age and older. To ensure that the child's play is both safe and fun, please review the operating instructions and these general safety rules with the child.

- DO NOT try to pick up vehicle while it's moving.
- Keep fingers, hair and loose clothing away from the tires and the wheel hubs while the vehicle is switched ON.
- DO NOT operate this vehicle in the presence of young children. Adult supervision is recommended during operation of this vehicle.
- DO NOT operate your vehicle indoors. The Big Bad Kong vehicle is an ultra-fast monster off-road truck.
- To avoid accidental operation, remove all batteries when not in use.
- DO NOT operate your vehicle on streets! They are for real cars.
- DO NOT operate your vehicle in crowded conditions.
- DO NOT aim your vehicle at fragile objects, people or animals.
- The Big Bad Kong vehicle is NOT a ride-on vehicle.

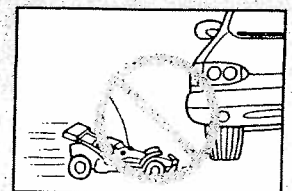

TROUBLESHOOTING

P = PROBLEM

C = POSSIBLE CAUSE

S = SOLUTION

P Vehicle does not run.

C Undercharged battery.

- S**
- Charge the battery. A new battery should have been charged for at least 18 hours before using the vehicle for the first time. After first-time use, recharge the battery for at least 14 hours after each use. NEVER charge the battery longer than 30 hours.
 - Check all connectors. Make sure the battery connector is tightly plugged into the charger connector and that the charger is plugged into the wall.
 - Make sure power flow to the wall outlet is ON.
 - The battery must be upright while charging.

C Charger is not working.

- S**
- There is no sure way to tell if your charger is working unless you have a voltmeter. If you suspect there is a problem with your charger, contact your local Power Wheels® authorized service center. They can test your charger for you.

C Battery's built-in thermal fuse has "tripped" and shut down the vehicle temporarily.

- S**
- The thermal fuse automatically "trips" and shuts down the vehicle temporarily if the driving conditions are too severe. After about 25 seconds, the fuse should automatically reset, permitting normal vehicle operation. If the thermal fuse trips repeatedly, please consult your local Power Wheels® authorized service center.

C Loose wire or loose connectors.

- S**
- Check all wires and connectors. Make sure the battery connector is tightly plugged into the vehicle's battery compartment socket, and that there are no loose wires around the motors.

C Dead battery.

- S**
- If your battery is old or if you have not followed battery care instructions, your battery may be dead. If you are unsure whether or not the battery is dead, you can have it tested at your local Power Wheels® authorized service center.

C Vehicle or transmitter switch not ON.

- S**
- Check vehicle and transmitter switches.

C Weak transmitter battery.

- S**
- Replace transmitter battery with fresh alkaline battery.

P Erratic operation or only short range possible.

C Radio interference likely.

- S**
- Change location (see point 2 - Quick Tips).

P Poor steering control.

C Weak transmitter battery.

- S**
- Replace transmitter battery with fresh alkaline battery.

P Short run time.

C Undercharged battery.

- S**
- Charge the battery. A new battery should have been charged for at least 18 hours before using the vehicle for the first time. After first-time use, recharge the battery for at least 14 hours after each use. NEVER charge the battery longer than 30 hours.
 - Check all connectors. Make sure the battery connector is tightly plugged into the charger connector and that the charger is plugged into the wall.
 - Make sure power flow to the wall outlet is ON.
 - The battery must be upright while charging.

C Overcharged battery.

- S**
- Do not charge the battery longer than 30 hours. If you suspect that your battery is damaged as a result of overcharging, contact your local Power Wheels® authorized service center. They can test your charger for you.

C Battery is old and will not accept full charge.

- S**
- Even with proper care, a rechargeable battery does not last forever. Average battery life is 1 to 3 years, depending on use conditions. Replace the battery with a Power Wheels® 6 volt battery. For best performance, do not use substitute parts.

P Vehicle runs sluggishly.

C Undercharged battery.

- S**
- Charge the battery. A new battery should have been charged for at least 18 hours before using the vehicle for the first time. After first-time use, recharge the battery for at least 14 hours after each use. NEVER charge the battery longer than 30 hours.
 - Check all connectors. Make sure the battery connector is tightly plugged into the charger connector and that the charger is plugged into the wall.
 - Make sure power flow to the wall outlet is ON.
 - The battery must be upright while charging.

C Battery needs charging.

- S**
- After your vehicle's normal running time, the battery will need to be recharged.

P Charger gets warm during use.

C It is normal for some chargers (but not all) to get warm during use; this is not a reason for concern.

- S**
- No action required.
 - If your charger does not get warm during use, this does not indicate a problem.

P Battery makes a sizzling or gurgling noise when charging.

C It is normal for some batteries (but not all) to make noise and swell slightly while charging; this is not a reason for concern.

- S**
- No action required.
 - If your charger does not make noise or swell slightly during charging, this does not indicate a problem.

P Vehicle doesn't work after going through water or snow.

C Water in the electronics area.

- S**
- Vehicle will take several hours to dry. Allow to dry thoroughly before trying again.
 - Operate your vehicle in a dry area. Avoid driving in water and snow.

© 2000 Mattel, Inc., Mt. Laurel, NJ 08054 U.S.A. PRINTED IN CHINA. All Rights Reserved. ® and ™ designate U.S. trademarks of Mattel, Inc.

tain this address for future reference: Mattel U.K., Ltd., Vanwall Business Park, Maidenhead SL6 4UB. Mattel Australia Pty., Ltd., Richmond, Victoria 3121 - Consumer Advisory Service: 1800 800 812 (valid only in Australia). Mattel East Asia Limited, 930 Ocean Centre, Harbour City, HK, China.

COMPLIANCE WITH FCC REGULATIONS

THIS DEVICE COMPLIES WITH PART 15 OF FCC RULES. OPERATION OF THIS DEVICE IS SUBJECT TO THE FOLLOWING TWO CONDITIONS:

- (1) THIS DEVICE MAY NOT CAUSE HARMFUL INTERFERENCE.
- (2) THIS DEVICE MUST ACCEPT ANY HARMFUL INTERFERENCE THAT MAY CAUSE UNDESIRE OPERATION.

This device generates and uses radio frequency energy and if not used properly may cause interference to radio and television reception. It has been tested and found to comply with the limits set by the FCC, which are designed to provide reasonable protection against such interference.

CAUTION: FCC Regulations state that changes or modifications to this product not expressly approved by the party responsible for compliance could void the user's authority to operate the equipment.

LIMITED WARRANTY

Radio Control Vehicle & Transmitter (the "Vehicle")
Battery & Charger (the "Battery")
(collectively the "Product")

Mattel, Inc. (the "Guarantor") warrants the Vehicle to be free from defects in material and workmanship for a period of ninety (90) days from the date of purchase, and warrants the Battery to be free from defects in material and workmanship for a period of six (6) months from the date of purchase. Guarantor will repair or replace the Vehicle and/or the Battery (at its sole option) if any such defect should appear within the applicable Warranty period. This Warranty applies only to the original purchaser. PLEASE RETAIN YOUR ORIGINAL DATED PURCHASE RECEIPT.

Because of the unique nature of this vehicle, two different procedures apply to warranty claims concerning (a) the Vehicle and (b) the Battery. Please read this Warranty carefully for details.

VEHICLE WARRANTY CLAIMS (90-DAY LIMITED WARRANTY)

In the event of a covered defect with respect to the Vehicle:

In the event of such a defect occurring within the applicable Warranty period, DO NOT RETURN THE VEHICLE TO THE STORE. Instead, please call the TYCO® R/C toll-free number listed below. Many problems can be solved in this manner. If necessary, you will be given an authorization number to return the Vehicle, postage prepaid insured, to the TYCO® R/C Consumer Affairs Department (please see address below). Enclose your name and address, your dated receipt, and an explanation of the defect. If the defect is covered by this warranty, replacement will be FREE OF CHARGE (less shipping and handling costs). Please do not send products without authorization; delays in service will result.

BATTERY WARRANTY CLAIMS (6-MONTH LIMITED WARRANTY)

In the event of a covered defect with respect to the Battery:

In the event of such a defect occurring within the applicable Warranty period, DO NOT RETURN THE BATTERY TO THE STORE. Instead, please call 1-800-348-0751 for specific instructions and for the location of the nearest POWER WHEELS® Authorized Service Center.

NOT COVERED UNDER WARRANTY

This Warranty covers normal use and does not cover the Product if it has been damaged by unreasonable use, neglect, accident, abuse, misuse, improper service or other causes not arising out of defects in materials or workmanship. Failure to furnish an original dated purchase receipt may result in the Product not being covered by this Warranty.

LIMITATIONS AND EXCLUSIONS

The Guarantor's sole and exclusive liability for defects in material and workmanship shall be limited to repair or replacement of the Product (at its sole option), and the Guarantor shall not be liable for incidental, consequential, or contingent damages (except in those states that do not allow this exclusion or limitation). This Warranty is exclusive, and is made in lieu of any other express or implied warranty. This warranty gives you specific legal rights. You may have other rights which vary from state to state. This Warranty (and toll-free numbers) valid in the U.S.A. only.

TOLL-FREE NUMBER & ADDRESS FOR VEHICLE WARRANTY CLAIMS:

PHONE NUMBER:

1-888-557-TYCO (1-888-557-8926)

Call between 8:00 a.m. - 5:00 p.m. Eastern Standard Time, Monday - Friday.

Expect some delay in January following the holiday season. Please be patient and keep trying the toll-free number.

ADDRESS:

TYCO® R/C CONSUMER AFFAIRS
636 GIRARD AVENUE
EAST AURORA, NY 14052

TOLL-FREE NUMBER & ADDRESS FOR BATTERY WARRANTY CLAIMS:

PHONE NUMBER:

1-800-348-0751

Call between 8:00 a.m. - 5:00 p.m. Eastern Standard Time, Monday - Friday.

Expect some delay in January following the holiday season. Please be patient and keep trying the toll-free number.

ADDRESS:

POWER WHEELS® CONSUMER AFFAIRS
636 GIRARD AVENUE
EAST AURORA, NY 14052