

Pirate's Island

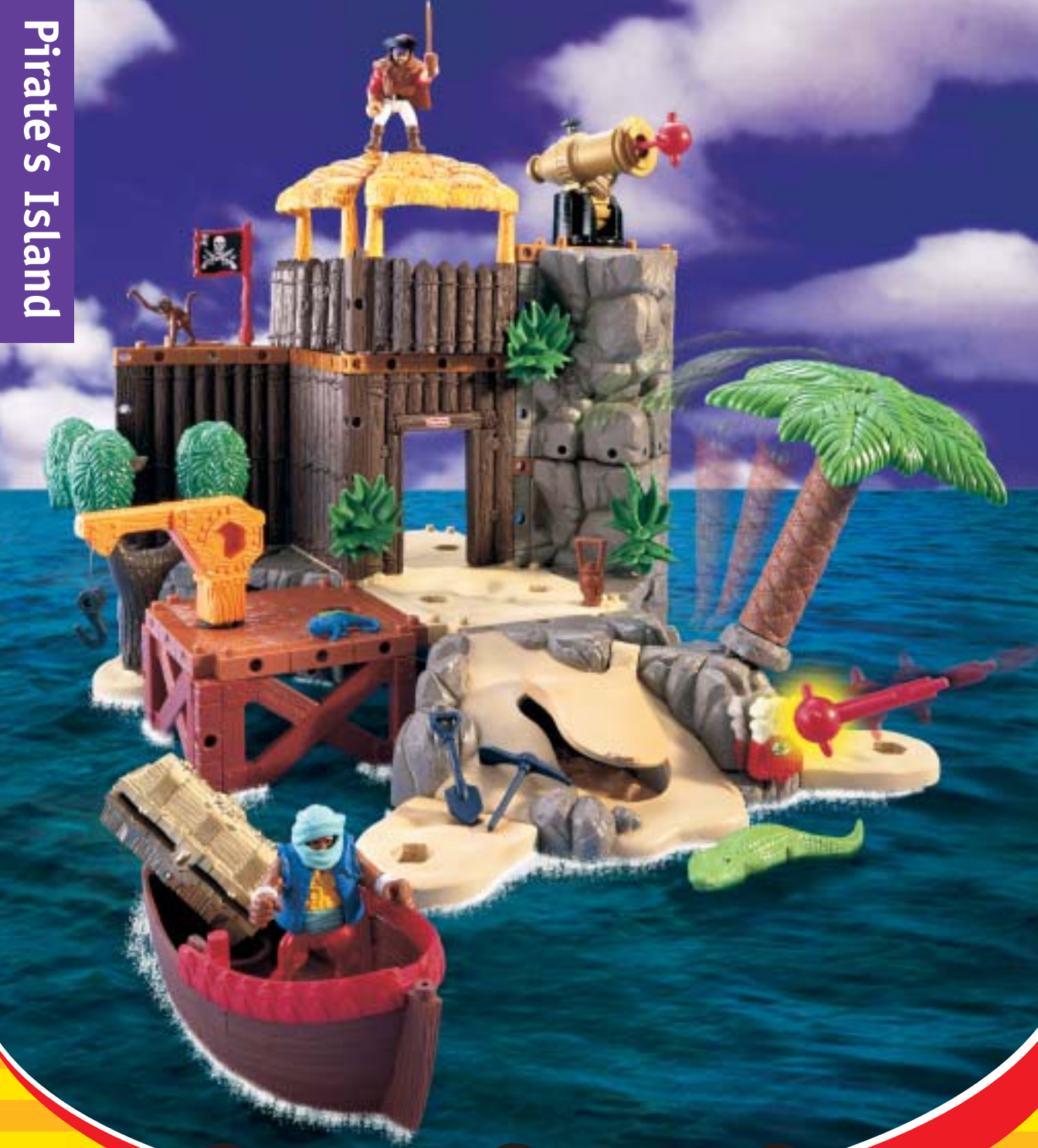

**imaginext** SYSTEM

Fisher-Price

[www.fisher-price.com](http://www.fisher-price.com)

Model  
B1473

# Welcome to the Imaginext™ System

The Imaginext™ system lets your child's imagination come alive. With Quick-Snap Panels™, kids can build different structures in lots of different ways. Use some of the parts or all of them!

*Preschool children will enjoy using all parts of this toy to build structures of their own creation. At first they will need parental assistance to build the structure on the front cover. It may be easier to use our step-by-step instructions and give your preschooler only the parts that will be assembled in each step. The more your child plays with this toy, and development and skill increases, the less assistance your child will need!*



Each sold separately and subject to availability.

Please keep this instruction sheet for future reference, as it contains important information.  
For children 4-10 years.

# Let's Build It!

1.

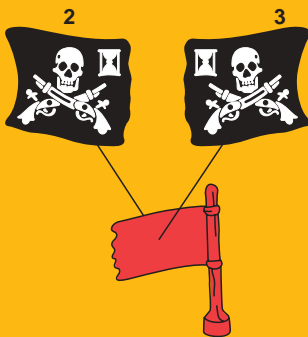

• Proper label application will help to keep the labels looking their best! When applying labels, keep the following guidelines in mind:

- Wash your hands before applying the labels.
- Before applying the labels, wipe the surfaces of this toy with a clean, dry cloth to remove any dust or oils.
- Place the labels exactly as shown in the illustrations.
- For best results, avoid repositioning a label once it has been applied.

2.

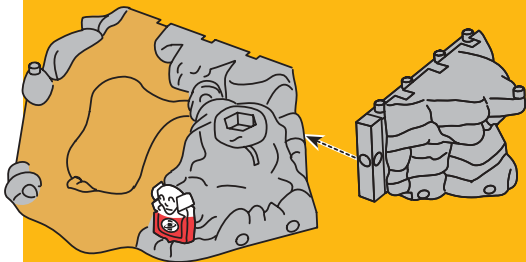

3.

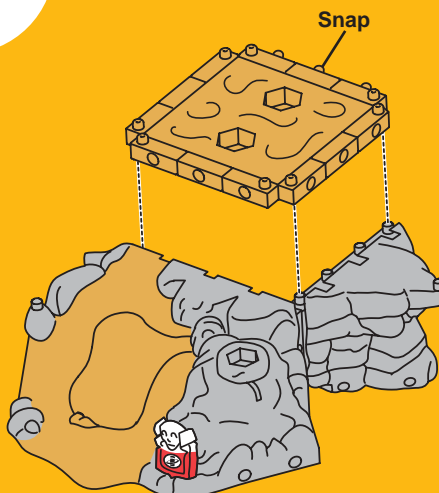

# Let's Build It!

4.

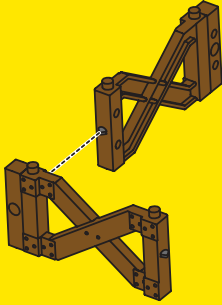

5.

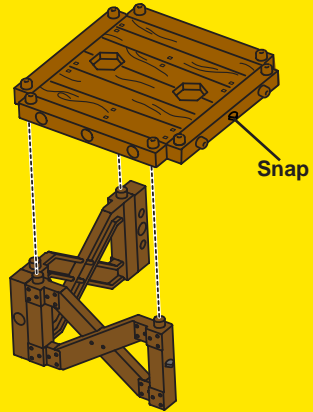

6.

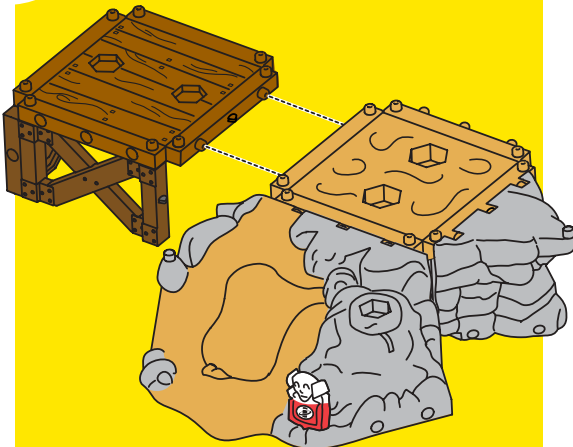

7.

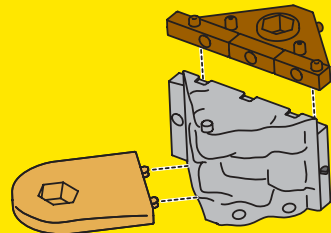

# Let's Build It!

8.

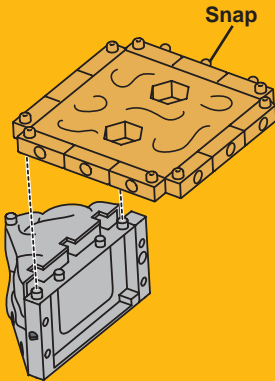

9.

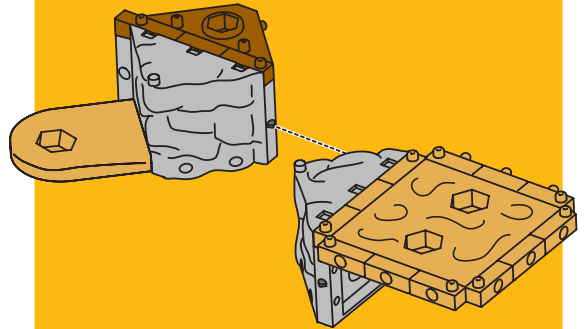

10.

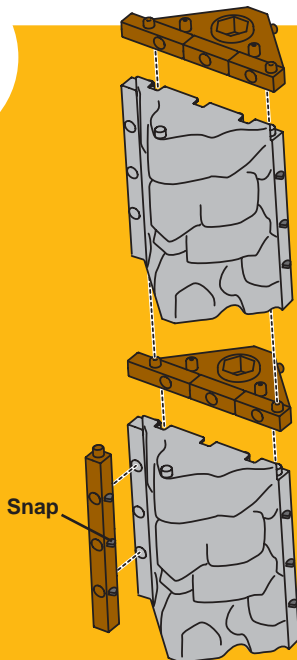

11.

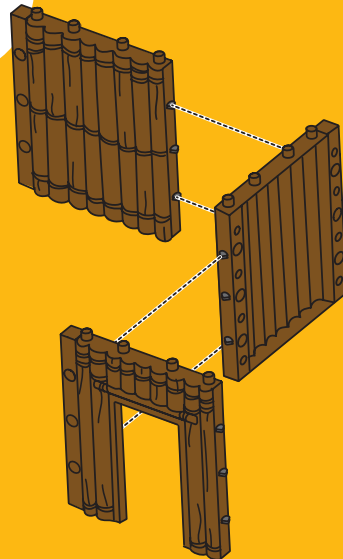



# Let's Build It!

12.

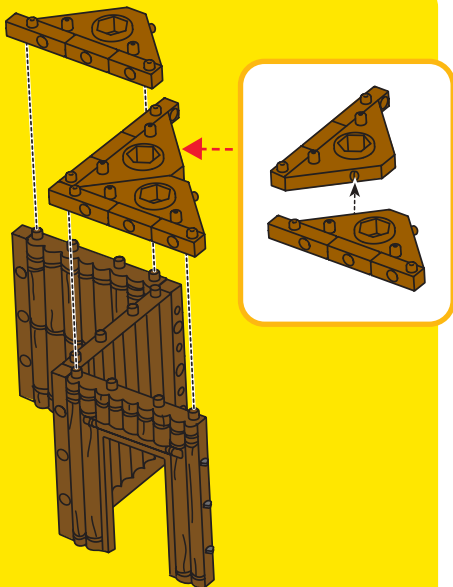

13.

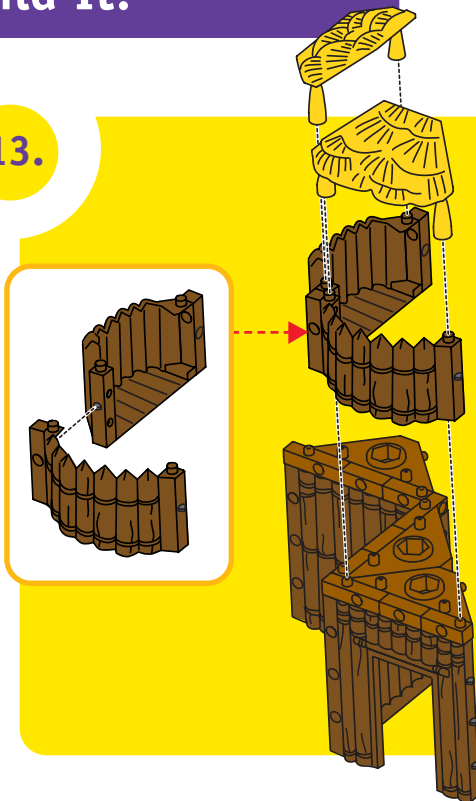

14.

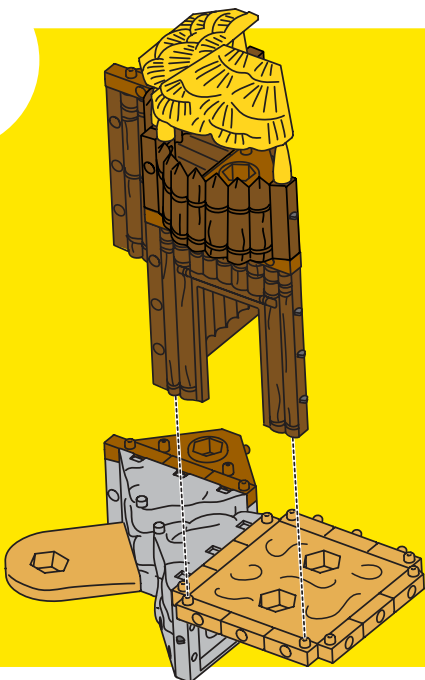

15.

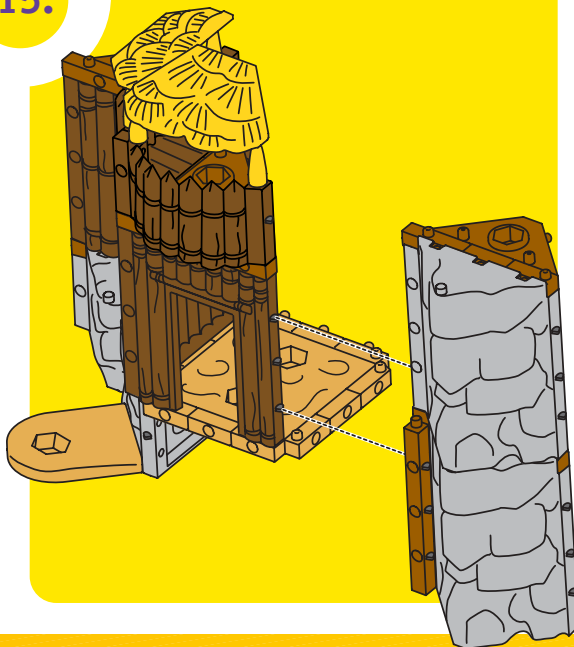

# Let's Build It!

16.



# Let's Build It!

17.

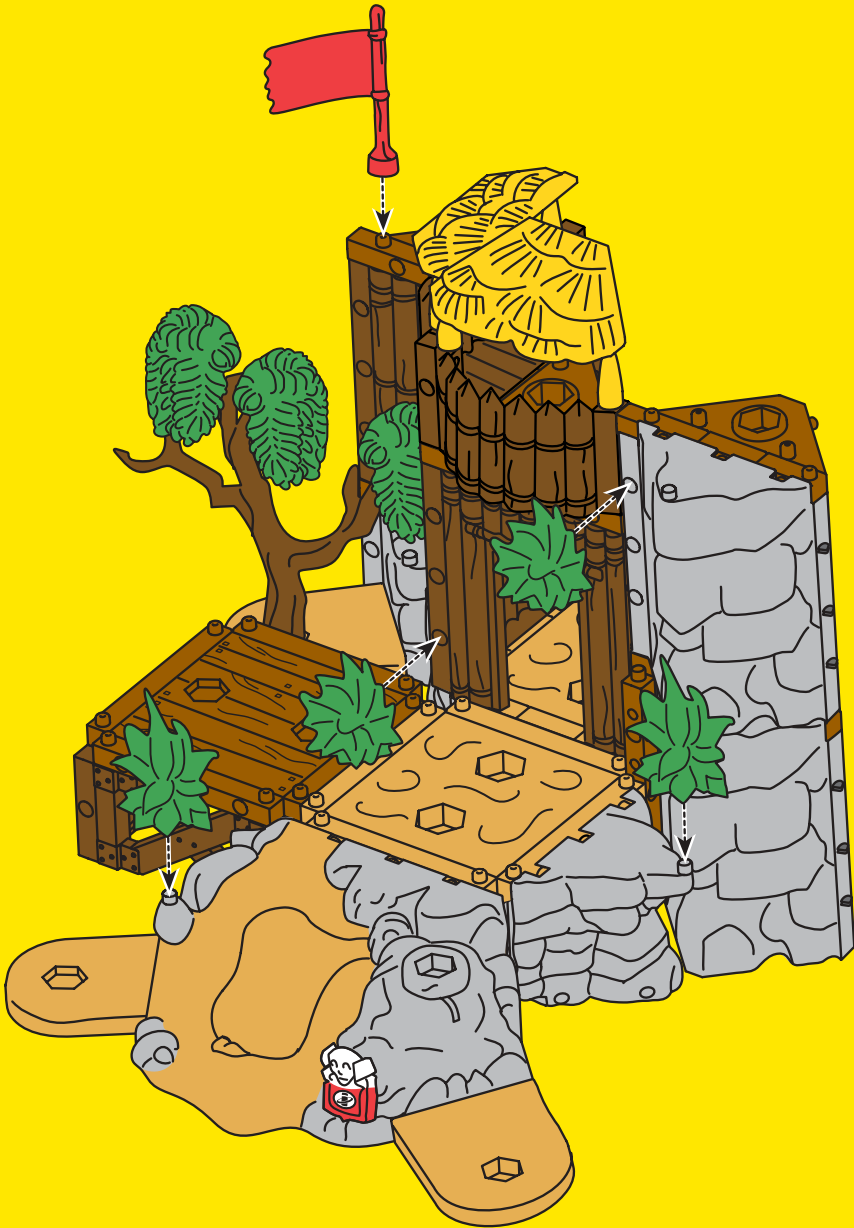





## Imagine... So Many Ways To Build!

With so many ways to build your playset, you can create a new adventure every time you play!



## Warning and Caution

### **WARNING**

Warning – Choking Hazard  
Not recommended for children under 3 years because it contains small parts that can be swallowed.

### **CAUTION**

- Do not launch the projectile at close range.
- Only use the projectile supplied with this toy.
- Do not fire at people or animals.

## Care

Wipe the toy with a clean cloth dampened with a mild soap and water solution.  
Do not immerse the toy.



**imaginext** SYSTEM™

**Questions? We'd like to hear from you!**

Call Fisher-Price® Consumer Relations, toll-free at **1-800-432-5437**,  
8 AM - 6 PM EST Monday through Friday.

Hearing-impaired consumers using TTY/TDD equipment,  
please call 1-800-382-7470. Or, write to:

Fisher-Price® Consumer Relations, 636 Girard Avenue, East Aurora, New York 14052. U.S.A.

For other countries outside the United States: **Canada:** call **1-800-567-7724**, or write to: Mattel Canada Inc.,  
6155 Freemont Blvd., Mississauga, Ontario L5R 3W2. **Great Britain:** telephone 01628 500302.

**Australia:** Mattel Australia Pty. Ltd., 658 Church Street, Locked Bag #870, Richmond, Victoria 3121 Australia.

Consumer Advisory Service 1300 135 312. **New Zealand:** 16-18 William Pickering Drive, Albany 1331, Auckland.  
**Asia:** Mattel East Asia Ltd, Room 1106, South Tower, World Finance Centre, Harbour City, Tsimshatsui, HK, China.