



Shopopolis™

people, places & things™ set



INSTRUCTIONS

CONTENTS

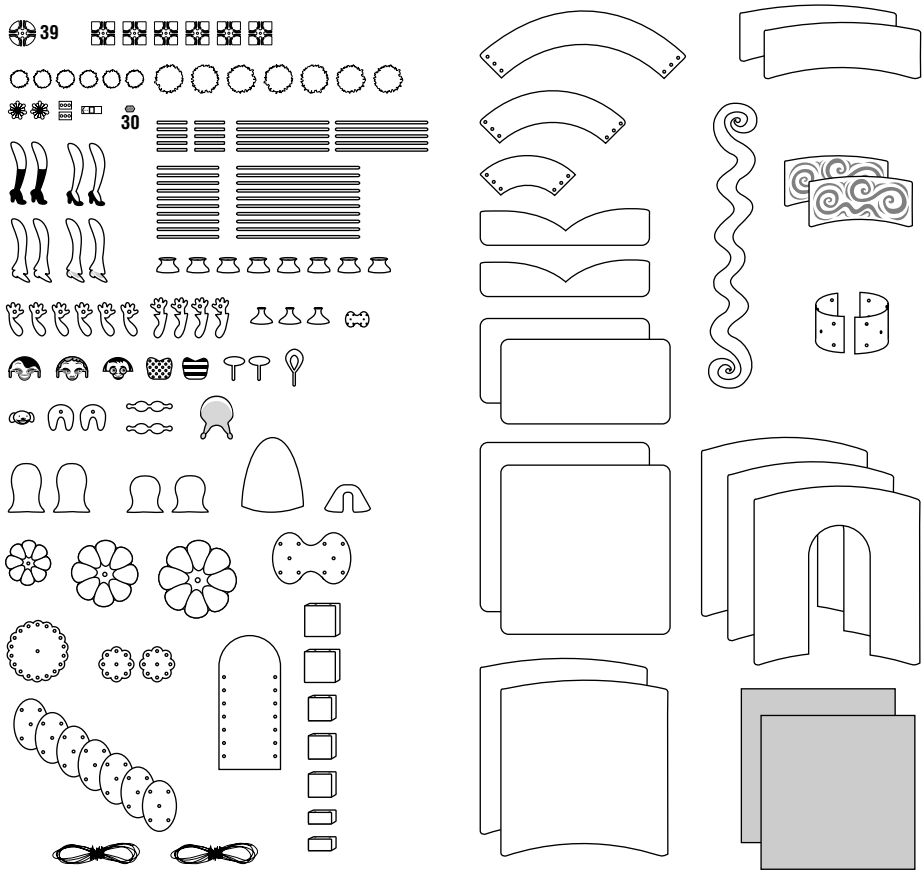

WARNING:
CHOKING HAZARD – Toy contains small balls and small parts.
Not for children under 3 years.

Save the product box for future storage.
Models shown cannot all be made at once.
Accessories not included.
Colors and decorations may vary from those shown.

Please remove everything from the package and compare to the contents shown here.
If any items are missing, please call 1-800-524-TOYS.

Keep these instructions for future reference as they contain important information.

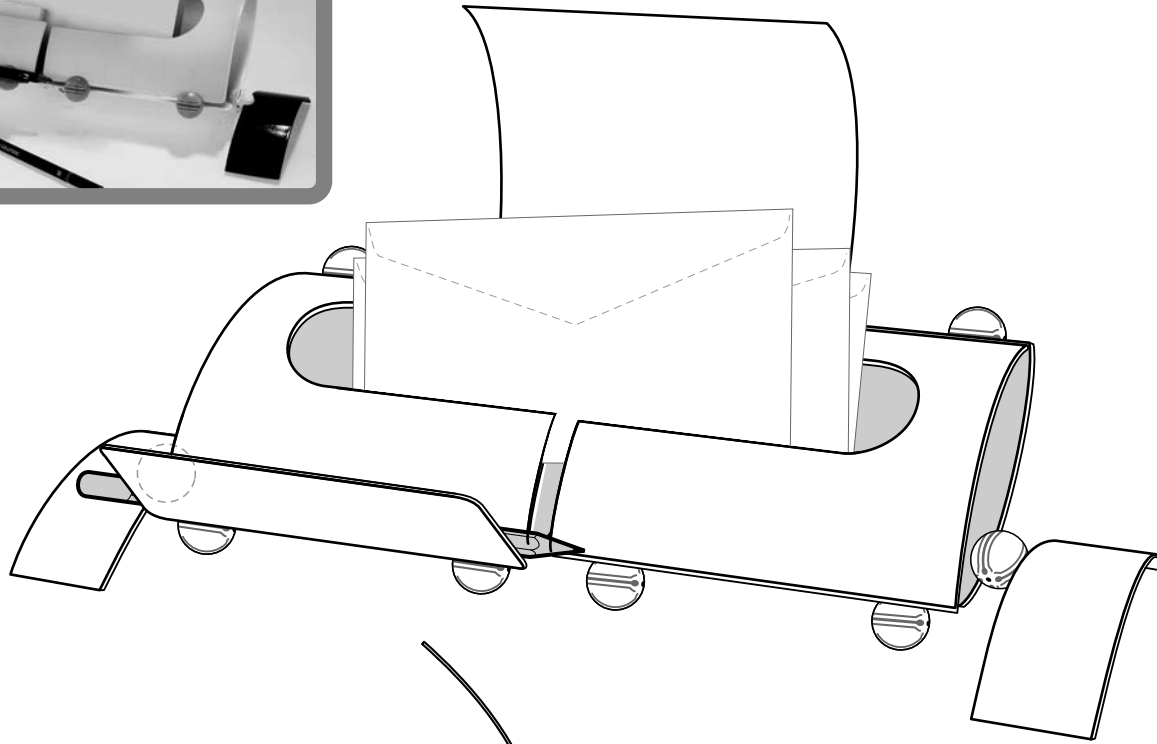

Side view

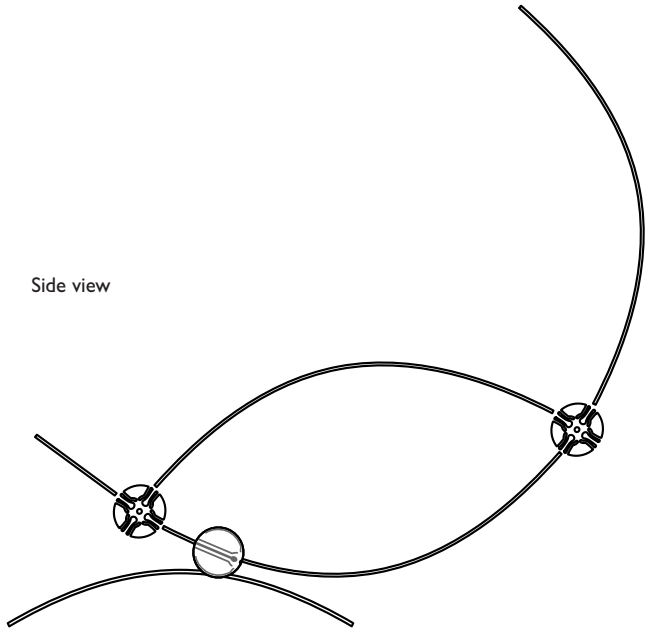

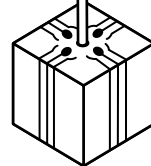
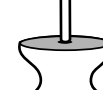
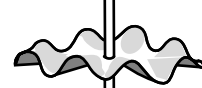
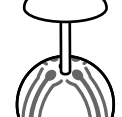
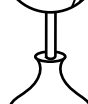
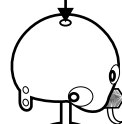
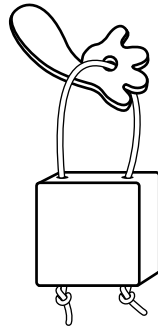
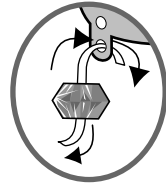
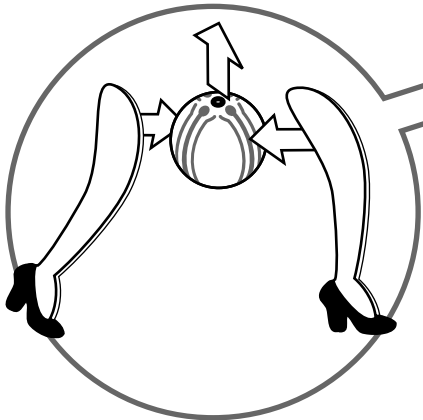
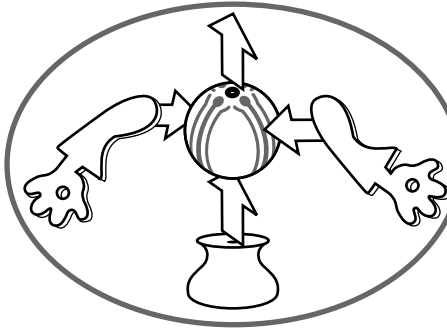
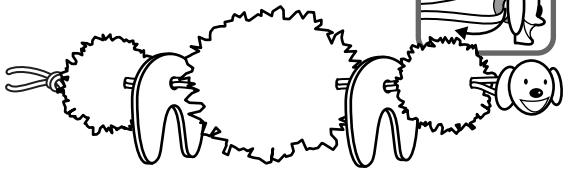
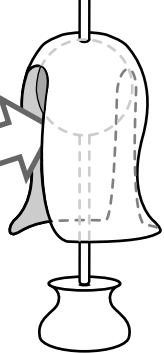
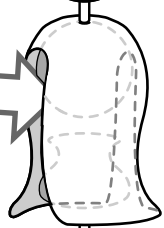
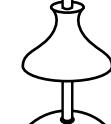
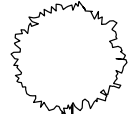
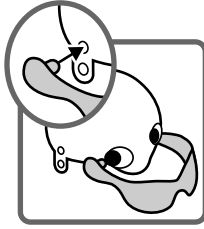

Stickers

Press for a few seconds to secure in place.

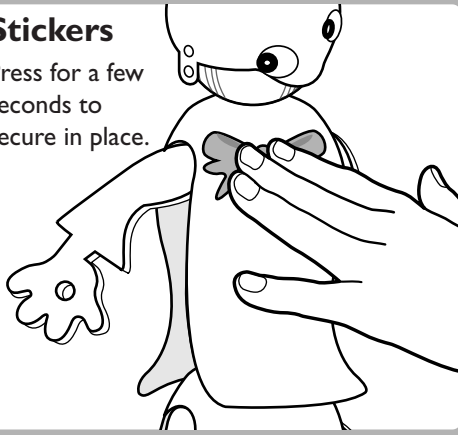

Bendy Wire

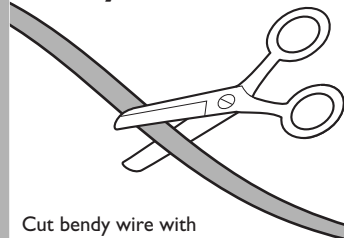

Cut bendy wire with scissors under adult supervision. Safety scissors will not cut the wire.

Photos

Insert photograph into small slot on connector.

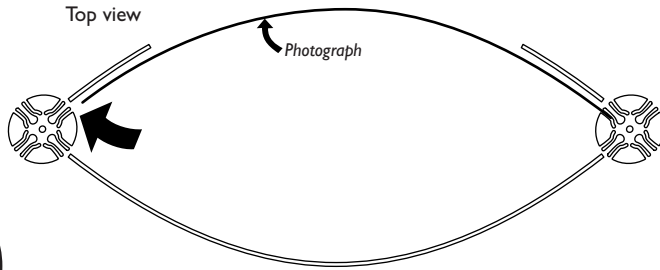

Front view

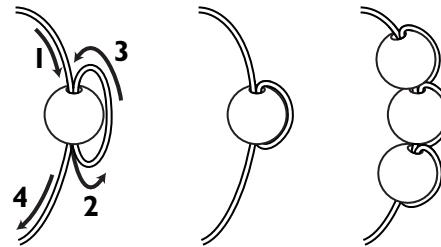
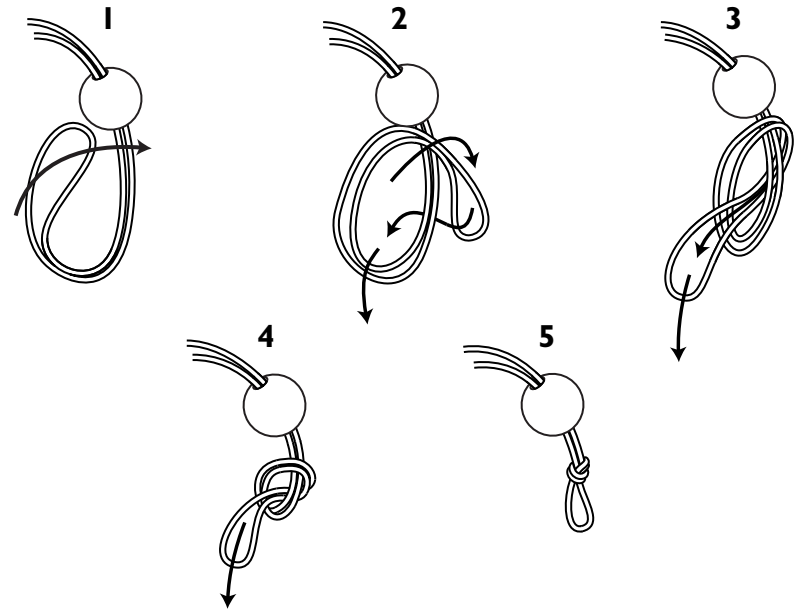
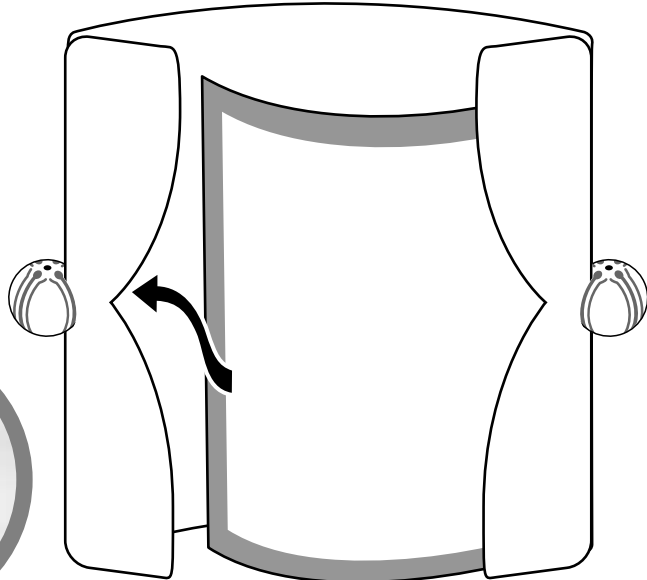

CONSUMER INFORMATION

YOU CAN TELL IT'S MATTEL!™ CALL us toll-free or write with any comments or questions about our products or service. Monday-Friday 8:00 a.m.-6:00 p.m. Eastern Time. Outside U.S.A., see telephone directory for Mattel listing.

Consumer Relations, Mattel, Inc.
333 Continental Blvd.
El Segundo, CA 90245 USA

1(800) 524-TOYS

WE ARE DEDICATED TO QUALITY PRODUCTS.

Mattel U.K., Ltd., Vanwall Business Park, Maidenhead SL6 4UB. Helpline 01628500303.

Mattel Australia Pty., Ltd., Richmond, Victoria 3121. Consumer Advisory Service 1300 135 312 (valid only in Australia).

Mattel East Asia Ltd, Room 1106, South Tower, World Finance Centre, Harbour City, Tsimshtsui, HK, China.

Diimport & Diedarkan Oleh: Mattel SEA Ptd Ltd.(993532-P) Lot 13.5, Menara Lien Hoe, Persiaran Tropicana Golf Country Resort, 47410