

Fisher-Price®

B8775

Kawasaki®

Ninja



Please keep this instruction sheet for future reference,
as it contains important information.

Adult assembly is required.

Tools required for assembly: Phillips Screwdriver,
Hammer and Scrap Block of Wood (not included).

Age: 2-5 years

Weight limit: 55 lbs (25 kg).

Consumer Information

⚠️ WARNING

To avoid serious injury:

- Adult supervision is required.
- Never use near cars and other motor vehicles, near streets, steps, sloped driveways, hills, roadways, alleys, swimming pool areas or other bodies of water.
- Always wear shoes or sneakers.
- Never allow more than one rider.

⚠️ CAUTION

This product contains small parts in its unassembled state. Adult assembly is required.

IMPORTANT!

- Please save all packaging material until assembly is complete to ensure that no parts are discarded.
- Please wipe each part with a clean, dry cloth before assembly.

Note: Some parts shown are assembled to both sides of the trike.

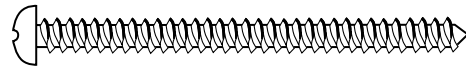

#8 x 2 1/4" Screw - 1



#8 x 3/4" Screw - 6



.354" Cap Nut - 2*

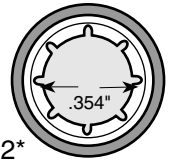

ALL SHOWN ACTUAL SIZE

*We've included one extra .354" cap nut for your convenience.

Note: Tighten and loosen the screws with a Phillips screwdriver. Do not over-tighten the screws.

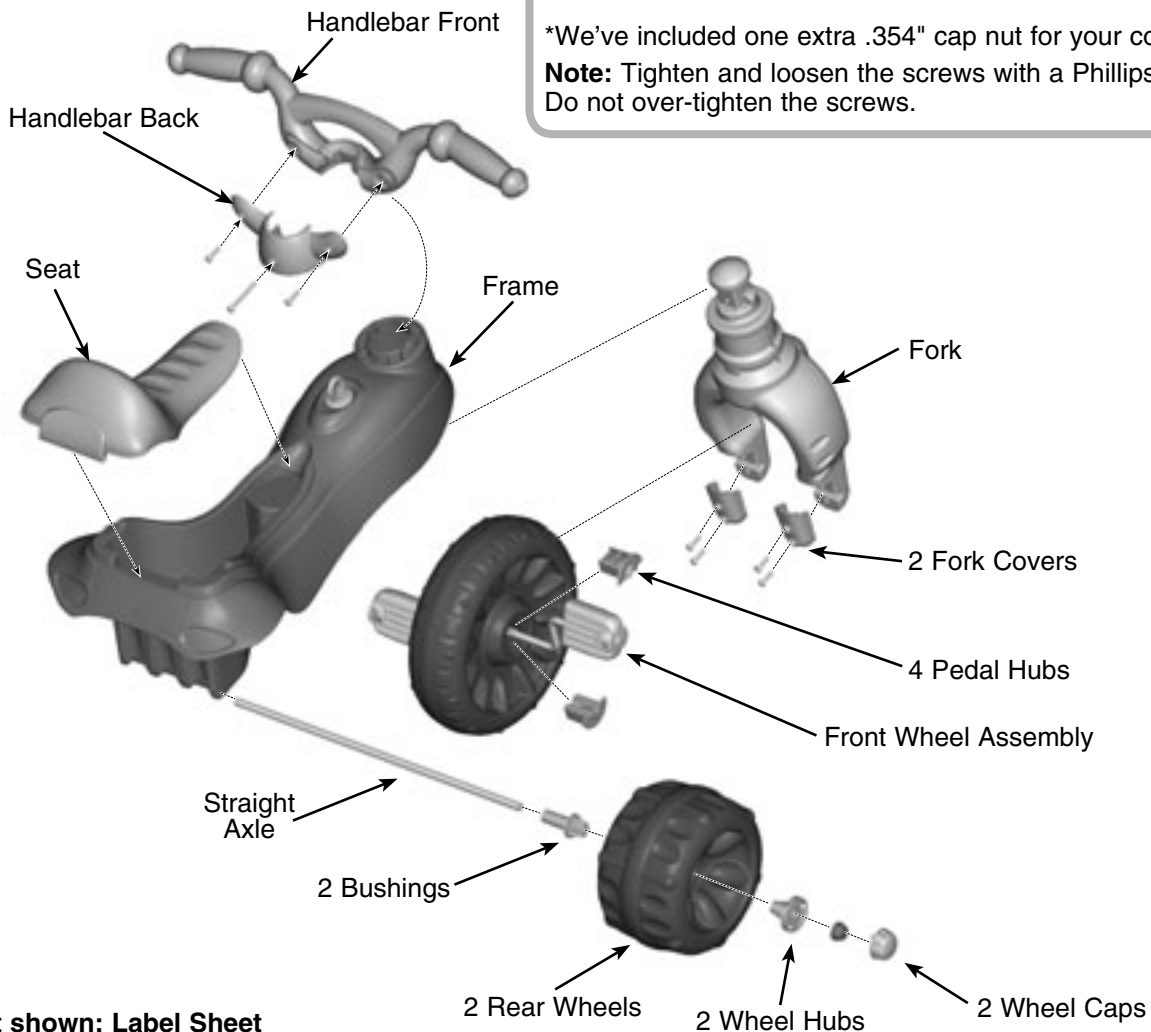

Part not shown: Label Sheet

Assembly

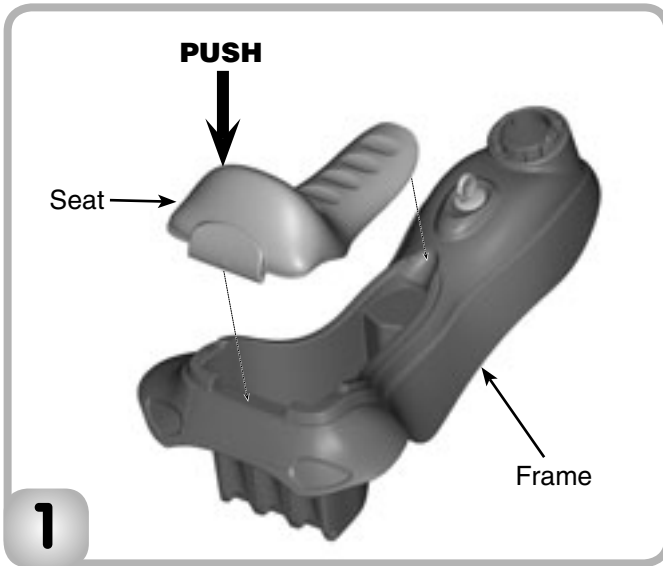

- Fit the seat onto the frame.
- Push firmly near the back end of the seat to "**snap**" it into place.

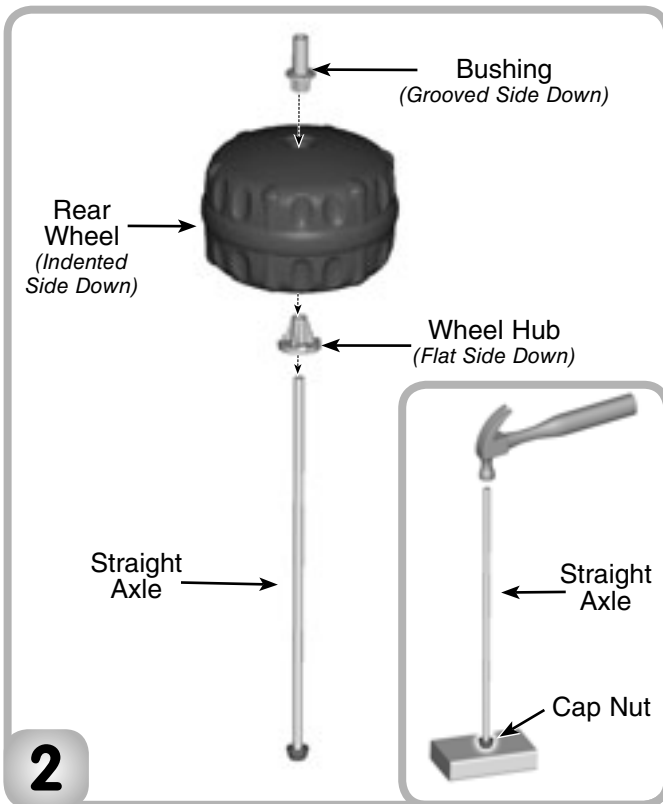

- Place one end of the straight axle into the cap nut. Tap the end of the straight axle with a hammer. **Make sure the cap nut is securely attached to the straight axle.**
- Slide a wheel hub, *flat side down*, onto the straight axle.
- Slide a rear wheel, *indented side down*, onto the straight axle.
- Slide a bushing, *grooved side down*, onto the straight axle.

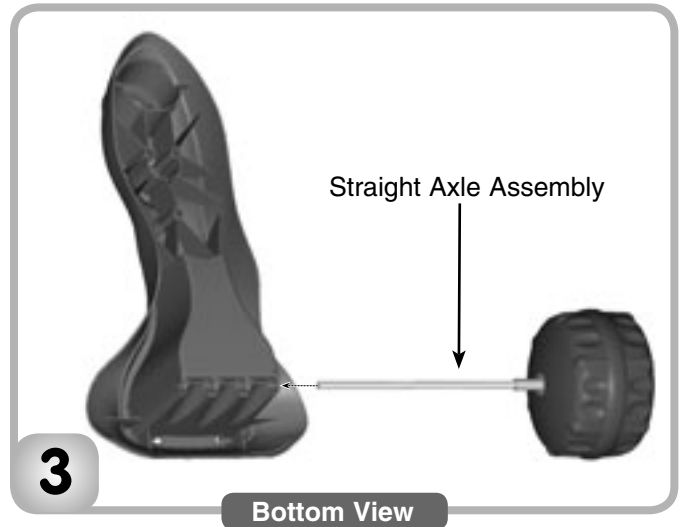

- Turn the frame upside down.
- Insert the straight axle assembly through the holes in the rear of the frame.

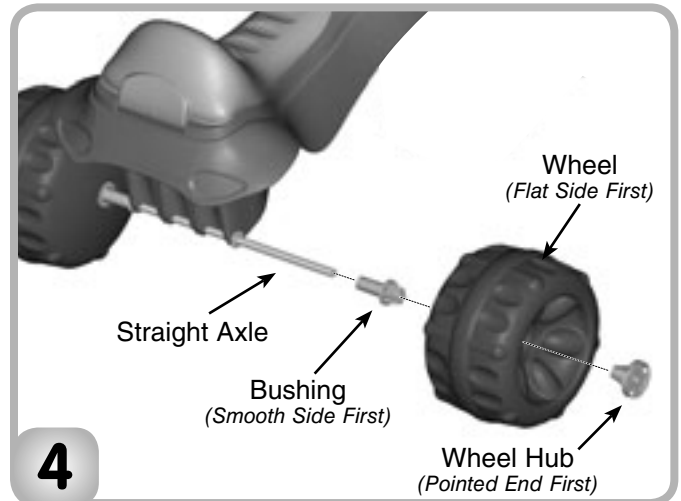

- Turn the assembly upright.
- Slide a bushing, *smooth side first*, onto the end of the straight axle.
- Slide a wheel, *flat side first*, onto the end of the straight axle.
- Slide a wheel hub, *pointed end first*, onto the end of the straight axle.

Assembly



5

- Fit the cap nut on the end of the straight axle.
- Tap the cap nut with a hammer. **Gently pull the rear wheel to be sure the cap nut is securely attached to the straight axle.**

Hint: You may need the help of another adult to hold the other end of the straight axle in place.



6

- Fit the tabs on the wheel cap into the slots in the wheel hub. Push to "**snap**" the wheel cap in place.
- Repeat this procedure to attach the other wheel cap to the other wheel hub.

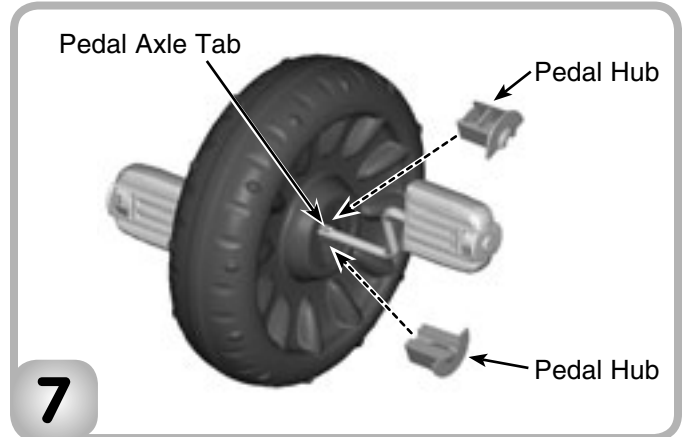

7

- Fit two pedal hubs onto the pedal axle tabs. Make sure the tabs fit into the slot in each pedal hub.
- While holding the pedal hubs on the pedal axle, insert the pedal axle into the hole in the center of the front wheel.
- Press the pedal hubs into the center of the front wheel until they are flush with the surface of the front wheel.
- Repeat this procedure for the other two pedal hubs on the other side of the front wheel assembly.

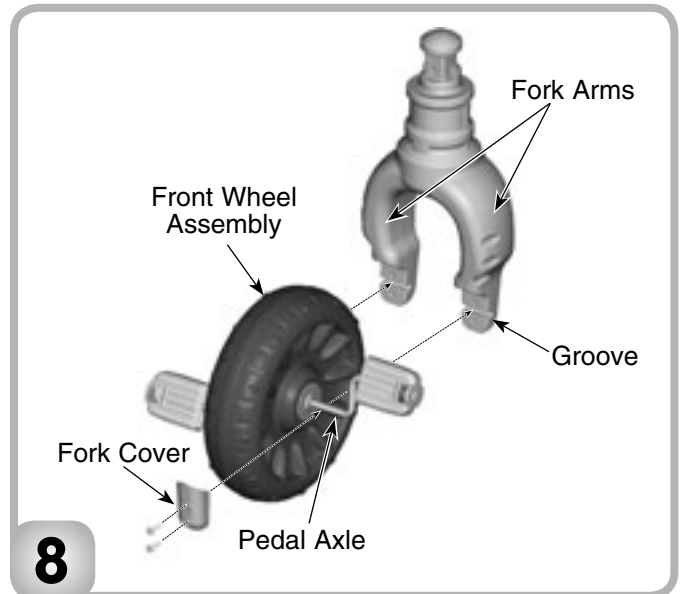

8

- Place the front wheel assembly between the fork arms. Make sure the pedal axle fits into the groove at the bottom of each fork arm.
- Place a fork cover over the pedal axle on one fork arm.
- Insert two #8 x $\frac{3}{4}$ " screws into the fork cover and tighten.
- Repeat this procedure to attach the other fork cover to the other fork arm.

Assembly

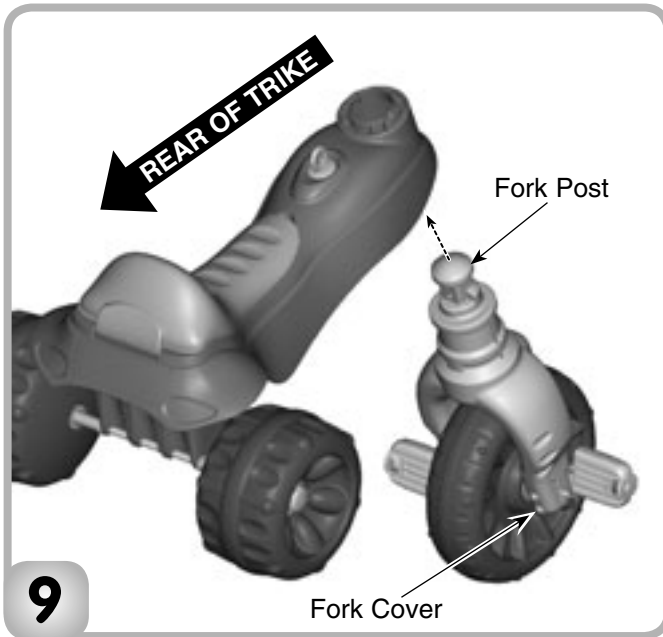

- Insert the fork post up through the hole in the neck of the frame. Make sure the fork is positioned so that the fork covers face the rear wheels.

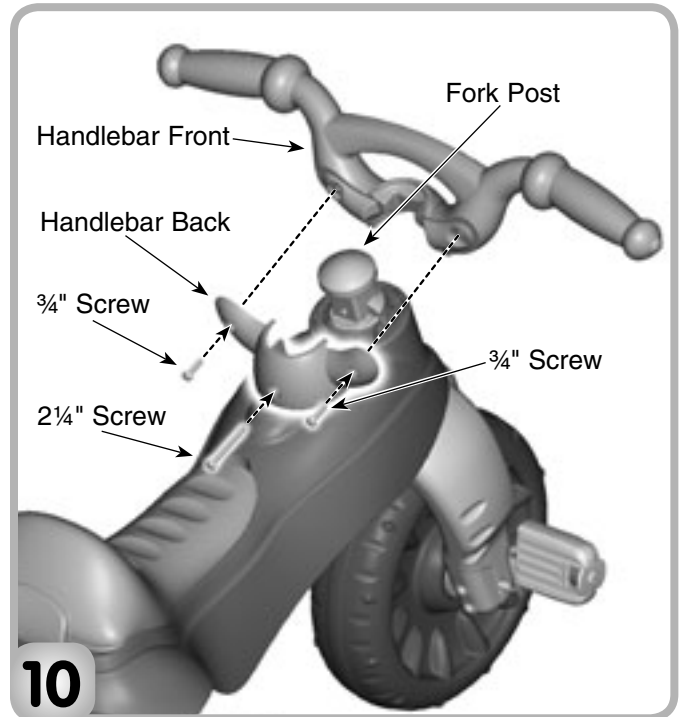

- Fit the handlebar front to the fork post.
- Hint:** The handlebar front is designed to assemble to the fork post one way.
- Fit the handlebar back to the fork post and handlebar front. Hold them together firmly.
 - First, insert the remaining #8 x 3/4" screws through the outer holes in the handlebar back and tighten.
 - Then, insert the #8 x 2 1/4" screw through the center hole in the handlebar back and tighten.

Label Decoration

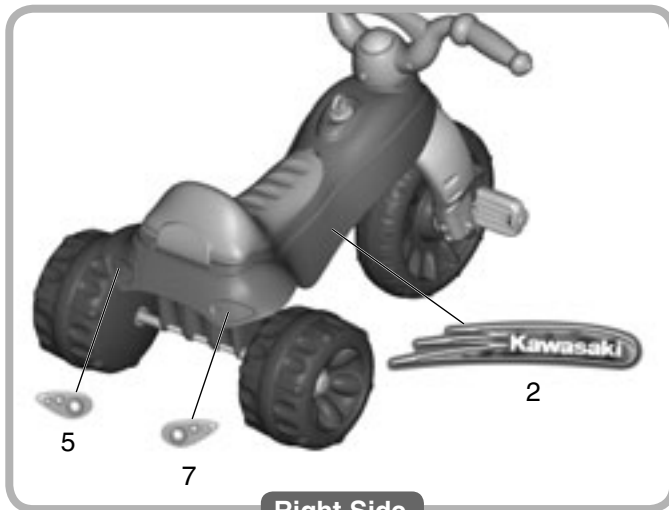

Right Side

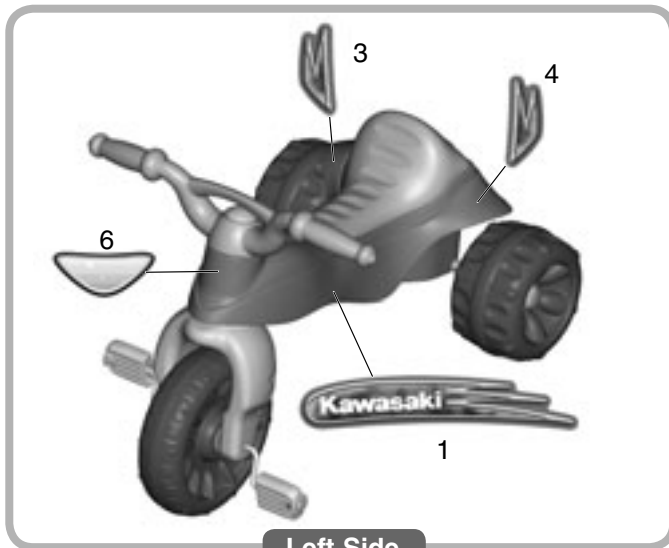

Left Side

Proper label application will help to keep the labels looking their best!

- Wash your hands before applying the labels.
- Make sure the areas where the labels will be applied are clean and dry. Wipe your vehicle with a clean, soft, dry cloth to remove any dust or oils.
- For best results, avoid applying a label more than once.
- Apply the labels as shown in the illustration above.
- After applying a label, rub the label firmly with a cloth to make sure the label is adhered to your vehicle.

Assembly is complete.

Consumer Information

- Periodically, check the plastic parts and if broken or cracked, dispose of them properly.
- Periodically, check all fasteners regularly to be sure they are tight. If the fasteners are not tight, tighten them as necessary.
- To clean, use a mild soap and water solution and a clean cloth. Rinse clean with water to remove soap residue.

IMPORTANT! It is a good practice to start training children very young regarding the importance of helmet use. When children are older and riding bicycles and faster vehicles, it is important that they use a helmet each and every time they ride. For this reason, even while riding a tricycle, it is a good idea to familiarize your child with helmet use, so that it becomes a habit for life. Choose a helmet that complies with requirements of the applicable certifying agency for bicycle helmets.



CONSUMER ASSISTANCE

Call toll free: 1-800-432-5437 (US & Canada only)
M-F 9AM to 7PM / SAT 11AM to 5PM (EST)

service.fisher-price.com

Write to us at: Fisher-Price® Consumer Relations,
636 Girard Avenue, East Aurora, New York 14052.

Hearing-impaired consumers using TTY/TDD equipment,
please call 1-800-382-7470.

For countries outside the United States:

Canada: Mattel Canada Inc., 6155 Freemont Blvd.,
Mississauga, Ontario L5R 3W2; www.service.mattel.com.

Great Britain: Mattel UK Ltd. Vanwall Business Park, Maidenhead SL6 4UB. Helpline: 01628 500303.
www.service.mattel.com/uk

Australia: Mattel Australia Pty. Ltd., 658 Church Street,
Locked Bag #870, Richmond, Victoria 3121 Australia.
Consumer Advisory Service 1300 135 312.

New Zealand: 16-18 William Pickering Drive,
Albany 1331, Auckland.

Asia: Mattel East Asia Ltd, Room 1106, South Tower,
World Finance Centre, Harbour City, Tsimshatsui, HK, China.

Kawasaki, Ninja and associated trademarks are used under license by Kawasaki Motors Corp., U.S.A. However, this product is neither manufactured nor distributed by Kawasaki Motors Corp., U.S.A. Consumer inquiries should be directed to: Fisher-Price, Inc.

Fisher-Price, Inc., a subsidiary of Mattel, Inc., East Aurora, NY 14052 U.S.A.
©2008 Mattel, Inc. All Rights Reserved. ® and ™ designate U.S. trademarks of Mattel, Inc.