

Fisher-Price®

**BFT56
CKB84**

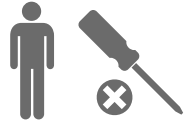

Keep this instruction sheet for future reference, as it contains important information.



Battery installation is required. Only adults should install batteries. Tool required for battery installation: Phillips screwdriver (not included).



Requires two AAA batteries for remote control (not included) and six AA batteries for Batbot (included).



Wipe toy with a clean, damp cloth. Do not immerse. This toy has no consumer serviceable parts. Do not take apart.

fisher-price.com

Battery Installation

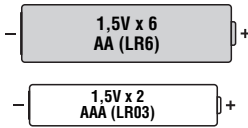

For longer life, use **alkaline** batteries.

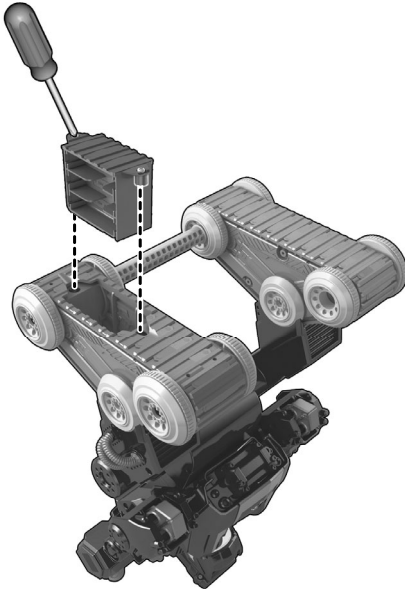

Batbot

- Loosen the screw in the battery compartment. Lift to remove the battery compartment.
- Remove the exhausted batteries and dispose of them properly.
- Insert six, new AA (LR6) **alkaline** batteries.
- Replace the battery compartment and tighten the screw.
- If Batbot begins to operate erratically, you may need to reset the electronics. Slide the power switch off and then back on again.

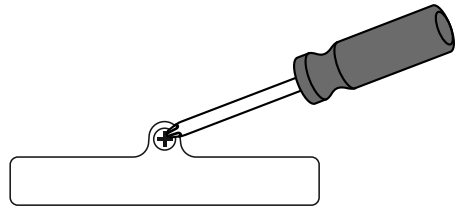

Remote Control

- Loosen the screw in the battery compartment door and remove the door.
- Insert two, new AAA (LR03) **alkaline** batteries.
- Replace the battery compartment door and tighten the screw.
- If the remote control begins to operate erratically, you may need to reset the electronics. Remove and reinstall the batteries.

Battery Safety Information

In exceptional circumstances, batteries may leak fluids that can cause a chemical burn injury or ruin your product. To avoid battery leakage:

- Do not mix old and new batteries or batteries of different types: alkaline, standard (carbon-zinc) or rechargeable (nickel-cadmium).
- Insert batteries as indicated inside the battery compartment.
- Remove batteries during long periods of non-use. Always remove exhausted batteries from the product. Dispose of batteries safely. Do not dispose of this product in a fire. The batteries inside may explode or leak.
- Never short-circuit the battery terminals.
- Use only batteries of the same or equivalent type as recommended.
- Do not charge non-rechargeable batteries.
- Remove rechargeable batteries from the product before charging.
- If removable, rechargeable batteries are used, they are only to be charged under adult supervision.

2-in-1 Transformation

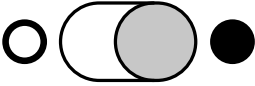



**BATBOT
POWER SWITCH**

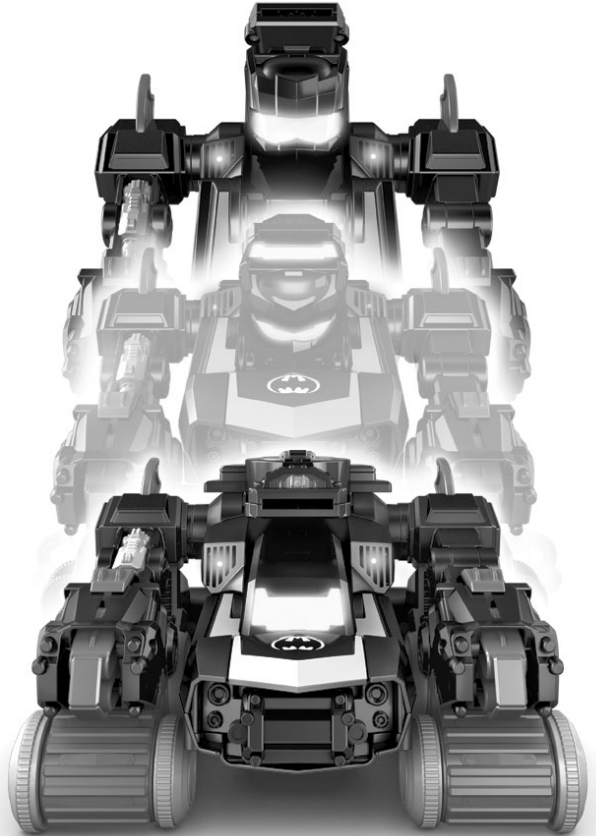

Remote Control



- Slide the Batbot power switch ON ● or OFF ○.
- Press the TRANSFORM button  to lower into Bat-Tank or raise to Batbot.
- Press and hold the FORWARD button  to move forward.
- Press and hold the BACK-UP AND TURN button  to back-up and turn.
- You can transform this toy using the turn disk. Place a figure (or your fingers!) in the disk and turn to transform!
- We do not recommend using the Batbot on carpets. For best performance, use on hard, flat surfaces.

Let's Fight Crime!



WARNING

Do not aim at eyes or face. Only use projectiles supplied with this toy.
Do not fire at point blank range.



- Open the hatch and insert the disks.
- Push the lever to fire at villains!

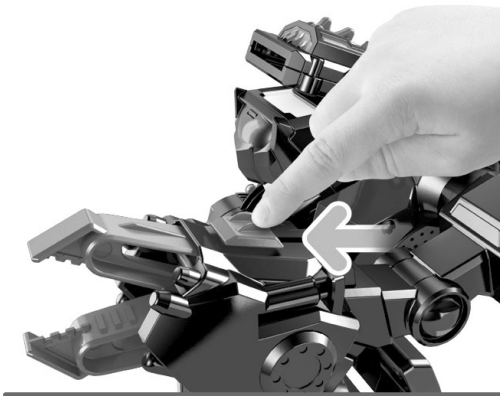

- Slide the switch completely forward the claw "chomping" action!

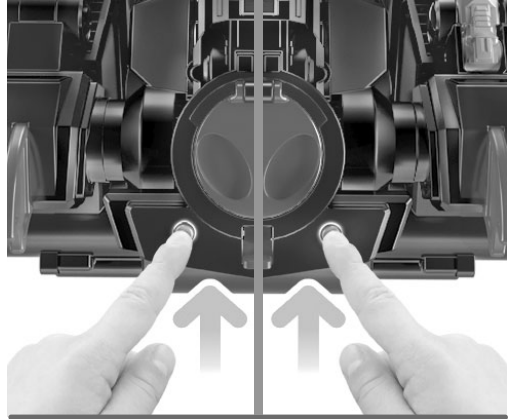

- Press the systems button or the mission button for cool phrases and lights!



- Lift or lower the blaster to activate sounds and lights!

Consumer Information

Troubleshooting

- This toy will enter “sleep mode” after a few minutes of inactivity. To turn this toy back on, press a systems or mission button, slide the claw switch, lift or lower the blaster or fire a disk.
- When movement/sound/lights from Batbot become slow/faint/stop, it is time for an adult to change the batteries.
- If Batbot does not respond to the remote control, it is time for an adult to change the batteries.
- If the remote control or Batbot are accidentally dropped in the water, remove the batteries and allow them to air dry. Replace with fresh batteries before operation.



- Protect the environment by not disposing of this product with household waste (2002/96/EC). Check your local authority for recycling advice and facilities.
- The toy is not to be connected to more than recommended number of power supplies.

FCC Statement (United States Only)

This equipment has been tested and found to comply with the limits for a Class B digital device, pursuant to Part 15 of the FCC rules. These limits are designed to provide reasonable protection against harmful interference in a residential installation. This equipment generates uses and can radiate radio frequency energy and, if not installed and used in accordance with the instructions, may cause harmful interference to radio communications. However, there is no guarantee that interference will not occur in a particular installation. If this equipment does cause harmful interference to radio or television reception, which can be determined by turning the equipment off and on, the user is encouraged to try to correct the interference by one or more of the following measures:

- Reorient or relocate the receiving antenna.
- Increase the separation between the equipment and receiver.
- Consult the dealer or an experienced radio/TV technician for help.

NOTE: Changes or modifications not expressly approved by the manufacturer responsible for compliance could void the user's authority to operate the equipment.

This device complies with Part 15 of the FCC Rules. Operation is subject to the following two conditions: (1) This device may not cause harmful interference, and (2) this device must accept any interference received, including interference that may cause undesired operation.

Consumer Information



CONSUMER ASSISTANCE

1-800-432-5437 (US & Canada)
1300 135 312 (Australia)

service.fisher-price.com

Fisher-Price, Inc., 636 Girard Avenue, East Aurora, NY 14052.
Hearing-impaired consumers: 1-800-382-7470.

Outside the United States:

Canada: Mattel Canada Inc., 6155 Freemont Blvd.,
Mississauga, Ontario L5R 3W2; www.service.mattel.com.

Great Britain: Mattel UK Ltd, Vanwall Business Park,
Maidenhead SL6 4UB. Helpline: 01628 500303.
www.service.mattel.com/uk

Mattel Europa B.V., Gondel 1, 1186 MJ Amstelveen, Nederland.

Australia: Mattel Australia Pty. Ltd., 658 Church Street,
Locked Bag #870, Richmond, Victoria 3121 Australia.

New Zealand: 16-18 William Pickering Drive,
Albany 1331, Auckland.

CAN ICES-3 (B)/NMB-3 (B)

Operation is subject to the following two conditions: (1) this device may not cause interference, and (2) this device must accept any interference, including interference that may cause undesired operation of the device.

L'utilisation de ce dispositif est autorisée seulement aux conditions suivantes : (1) il ne doit pas produire de brouillage et (2) l'utilisateur du dispositif doit être prêt à accepter tout brouillage radioélectrique reçu, même si ce brouillage est susceptible de compromettre le fonctionnement du dispositif.



DC SUPER FRIENDS: TM & © DC Comics.
WB SHIELD: TM & © Warner Bros. Entertainment Inc.
(s14)

©2014 Mattel. All Rights Reserved.

® and ™ designate U.S. trademarks of Mattel, except as noted.