

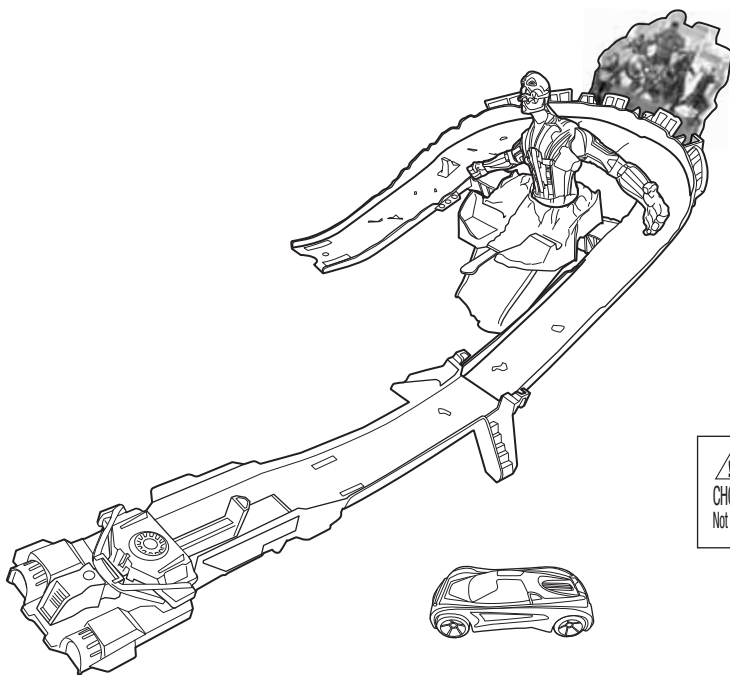

AVENGERS TOWER TAKEOVER™



WARNING:
CHOKING HAZARD - Small parts.
Not for children under 3 years.



CDD27-1100177551

4+

service.mattel.com
HOTWHEELS.COM

PLEASE KEEP THESE INSTRUCTIONS FOR FUTURE REFERENCE AS THEY CONTAIN IMPORTANT INFORMATION.

ASSEMBLY (CONTD.)

3.

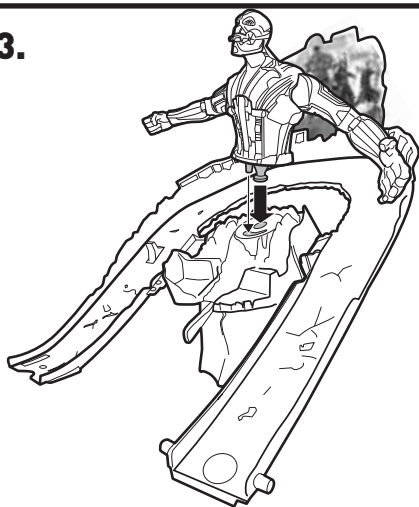

4.

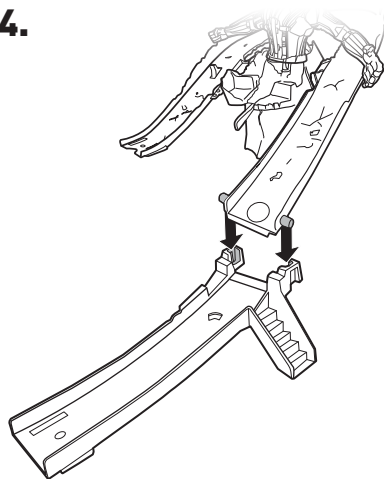

5.

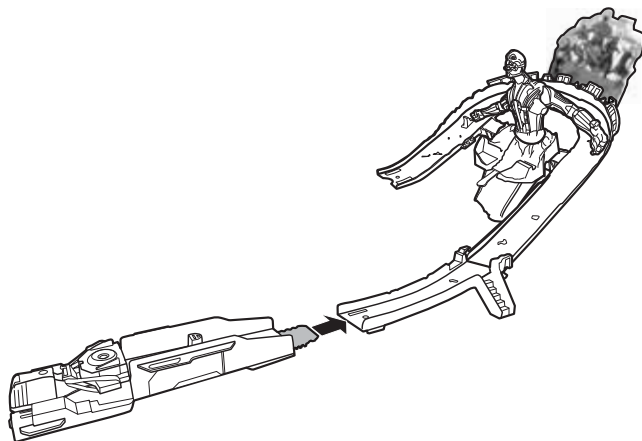

6. CONNECT TO OTHER HOT WHEELS® SETS (SOLD SEPARATELY).

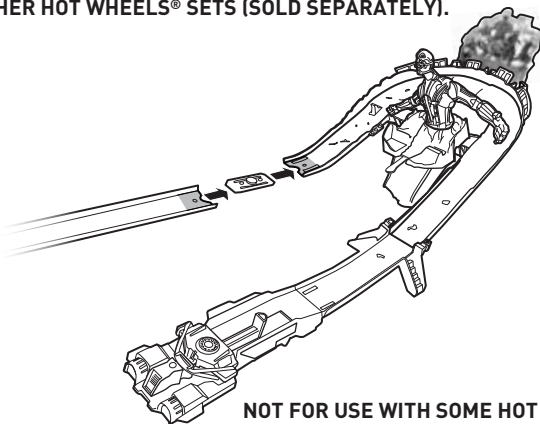

NOT FOR USE WITH SOME HOT WHEELS® VEHICLES.

TO PLAY

1. LOCK LAUNCHER BACK AND LOAD VEHICLE.

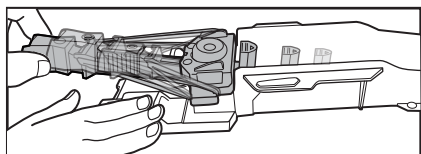

3-SPEED LAUNCHER
TRY DIFFERENT LAUNCH SETTINGS
TO FIND THE BEST PERFORMANCE.

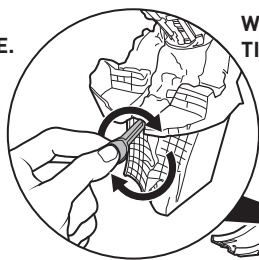

**WIND CRANK SEVERAL
TIMES AND LET GO.**

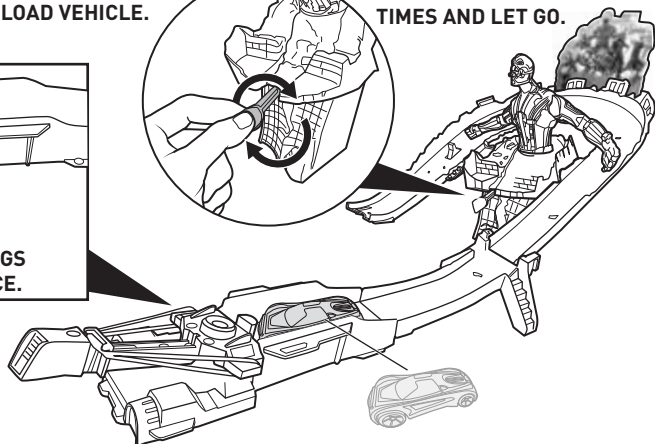

2. PUSH BUTTON TO LAUNCH AROUND THE CURVE!

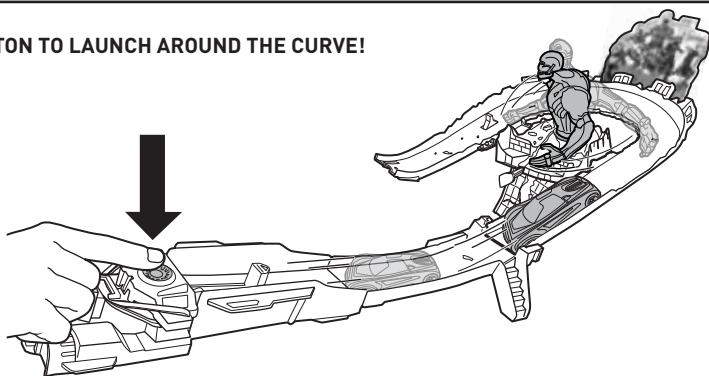

3. AVOID ULTRON'S ARMS TO HIT THE TRIGGER POINT AND TAKE HIM DOWN.

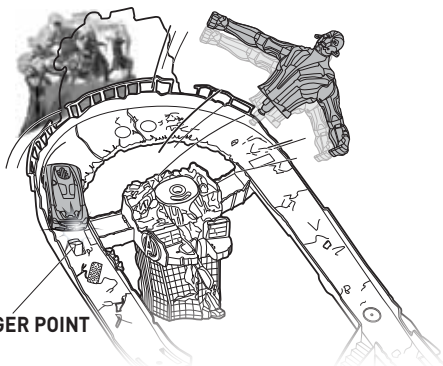

TRIGGER POINT

4. DON'T LET ULTRON KNOCK YOU OFF TRACK!

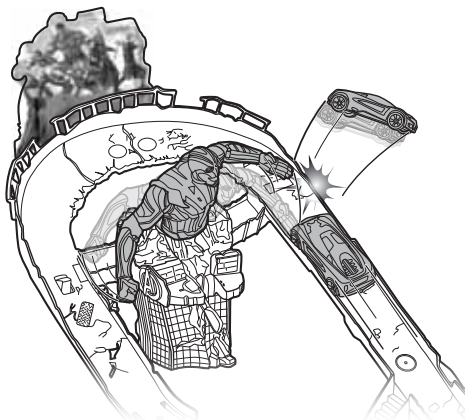

Warning: Do not aim at eyes or face. Only use projectiles supplied with this toy. Do not fire at point-blank range.

©2014 Mattel. All Rights Reserved. © and ™ designate U.S. trademarks of Mattel, except as noted. Mattel, Inc., 636 Girard Avenue, East Aurora, NY 14052, U.S.A. Consumer Relations 1-800-524-8697. Mattel U.K. Ltd., Vanwall Business Park, Maidenhead SL6 4UB. Helpline 01628 500303. Mattel Australia Pty., Ltd., Richmond, Victoria. 3121. Consumer Advisory Service - 1300 135 312. Mattel East Asia Ltd., Room 1106, South Tower, World Finance Centre, Harbour City, Tsimshatsui, HK, China. Diimport & Diedarkan Oleh: Mattel SEA Ptd Ltd.(993532-P) Lot 13.5, 13th Floor, Menara Lien Hoe, Persiaran Tropicana Golf Country Resort, 47410 PJ. Tel:03-78803817, Fax:03-78803867.