

Fisher-Price®



- Read all instructions BEFORE assembly and USE of product.
- **KEEP INSTRUCTIONS FOR FUTURE USE.**



- Adult assembly/setup is required. No tools required.



- The play yard, mattress, inclined sleeper frame and storage bag are surface washable.
- The inclined sleeper pad is machine washable. Remove the pad from the inclined sleeper frame and machine wash separately in cold water on the gentle cycle. Do not use bleach. Tumble dry on low heat.
- The changing station clutch is machine washable. Machine wash separately in cold water on the gentle cycle. Do not use bleach. Line dry.
- Product features and decorations may vary from photographs and images.



IMPORTANT! Before assembly/setup and each use, inspect this product for damaged hardware, loose joints, missing parts or sharp edges. DO NOT use if any parts are missing or broken. Contact Fisher-Price® for replacement parts and instructions if needed. Never substitute parts.

fisher-price.com

Play Yard Warnings



WARNING

Failure to follow these warnings and the instructions could result in serious injury or death.

- The product, including side rails, must be fully erected prior to use.
- Strings can cause strangulation! Never place items with a string around a child's neck such as hood strings or pacifier cords. Never suspend strings over product or attach strings to toys.
- Use only with a child who cannot climb out and is less than 35 inches (890 mm) in height.
- Child can become entrapped and die when improvised netting or covers are placed on top of product. Never add such items to confine child in product.
- Never place product near a window where cords from blinds or drapes can strangle a child.
- Always provide the supervision necessary for the continued safety of your child. When used for playing, never leave child unattended.
- To reduce the risk of Sudden Infant Death Syndrome (SIDS), pediatricians recommend healthy infants be placed on their back to sleep, unless otherwise advised by your physician.
- Never use this product if there are any loose or missing fasteners, loose joints, broken parts, or torn mesh/fabric. Check before assembly and periodically during use. Contact Fisher-Price® for replacement parts. Never substitute parts.
- **SUFFOCATION HAZARD**
 - Infants can suffocate:
 - In gaps between a mattress too small or too thick and product sides.
 - On soft bedding.
 - NEVER add a mattress, pillow, comforter, or padding.
- Never use plastic shipping bags or other plastic film as mattress covers not sold and intended for that purpose. They can cause suffocation.
- Make sure latches are secure.
- When child is able to pull to a standing position, remove bumper pads, large toys, and other objects that could serve as steps for climbing out.
- Use ONLY the mattress provided by Fisher-Price®.
- Never use a water mattress with this product.

Inclined Sleeper Warnings



WARNING: Failure to follow these warnings and the instructions could result in death or serious injury.

- **FALL HAZARD** – To prevent falls, stop using the inclined sleeper when infant:
 - Begins to roll over or
 - can pull up on sides, whichever comes first (approximately 5 months).
- **ALWAYS** use restraint system.
- **SUFFOCATION HAZARD**
 - Infants have suffocated:
 - In gaps between extra padding and side of a inclined sleeper.
 - On soft bedding. Use **ONLY** the pad provided by Fisher-Price®. **NEVER** add a pillow, comforter or extra padding.
 - When trapped between inclined sleeper and adjacent surfaces. **NEVER** use in play yard unless it's attached to the mounts on play yard.
 - **ALWAYS** place child on back to sleep.
- Strings can cause strangulation! Never place items with a string around a child's neck such as hood strings or pacifier cords. Never suspend strings over product or attach strings to toys.
- **ENTRAPMENT HAZARD**
 - Never leave the inclined sleeper in place when child is in the play yard.



**CONSUMER ASSISTANCE
AYUDA AL CONSUMIDOR**

1-800-432-5437 (US)



service.fisher-price.com

Fisher-Price, Inc., 636 Girard Avenue, East Aurora, NY 14052.

Hearing-impaired consumers/Clientes con problemas auditivos
1-800-382-7470.

Parts

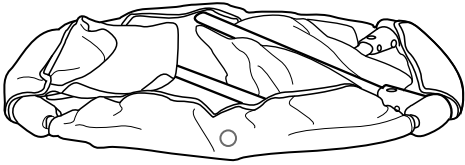

Play Yard

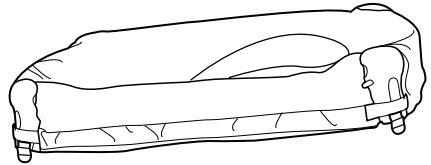

Inclined Sleeper Frame

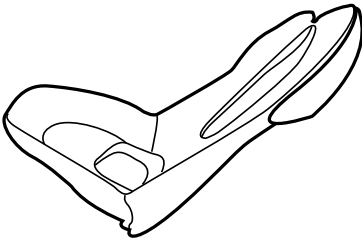

Inclined Sleeper Pad

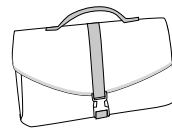

Changing Station Clutch

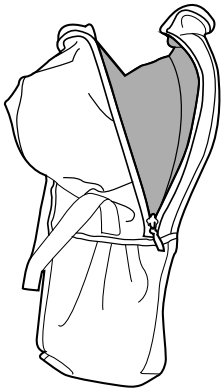

Storage Bag

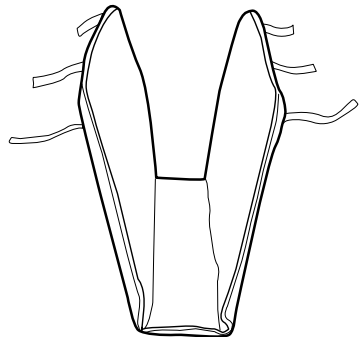

Mattress

Play Yard Setup

1

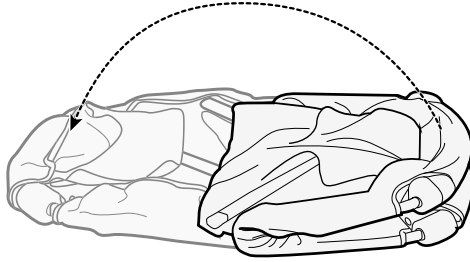

- Remove the play yard from the storage bag.
- Unfold the play yard.

A

Leg

2

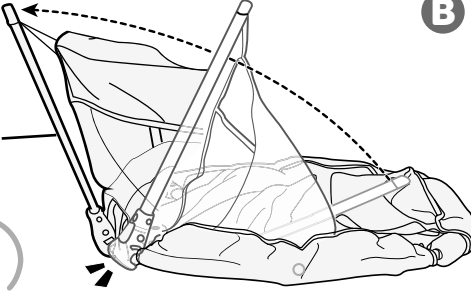

B

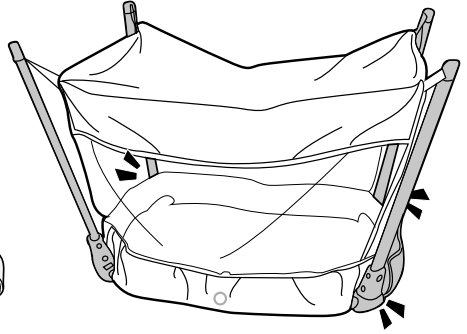

- Lift a leg until you hear a “click” **A**. Repeat this procedure to open each leg **B**.

3

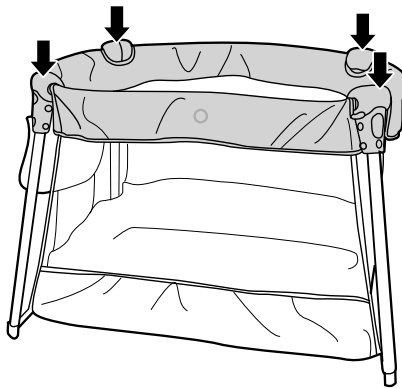

- Turn the play yard upright.
- Push down on the play yard top rails to make sure the legs are locked in place.

Play Yard Setup

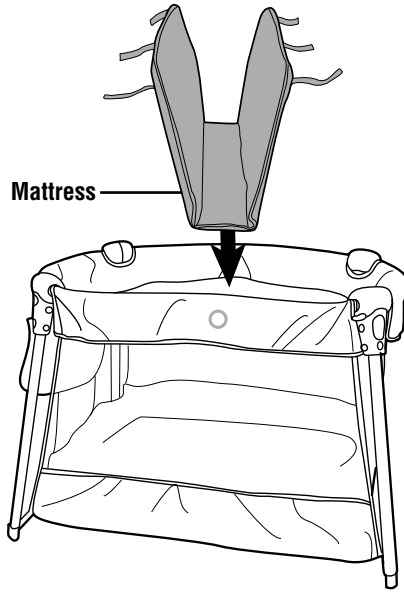

4

- Place the mattress in the bottom of the play yard.

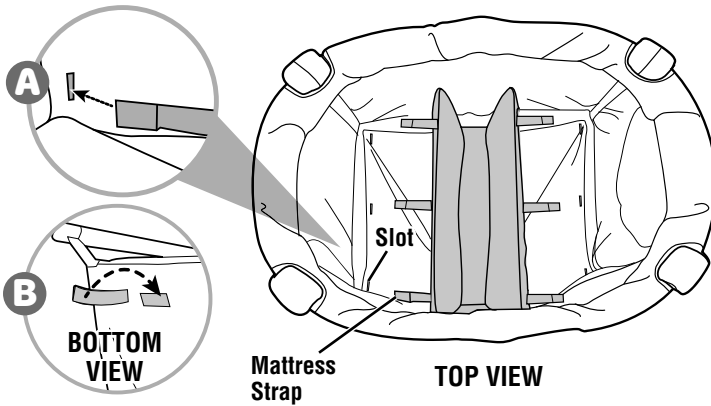

5

- Fit the strap on a corner of the mattress through the slot in corner of the play yard floor **A**.
- Repeat this procedure and fit the remaining five mattress straps through the slots in the play yard floor.
- Reach under the play yard floor and pull a strap down. Fasten it to the bottom of the play yard **B**.
- Repeat this procedure to fasten the remaining mattress straps.

Inclined Sleeper Setup

IMPORTANT! The inclined sleeper is only to be used attached to the play yard. Follow the Play Yard Setup instructions **BEFORE** following the instructions in this section.

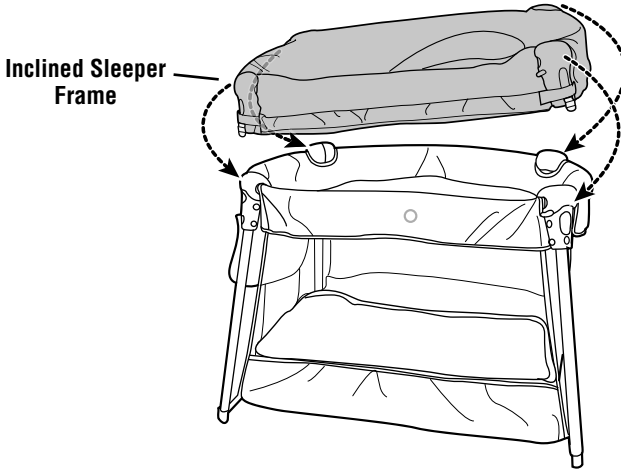

- Fit the inclined sleeper frame around the top rails of the play yard.

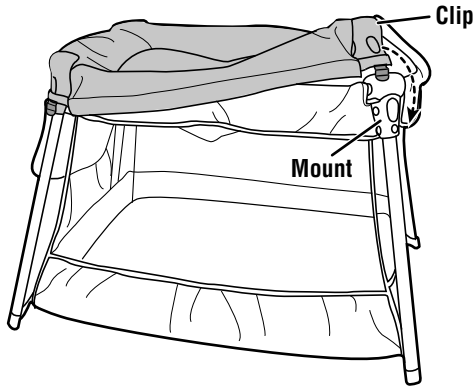

- Fit all four clips on the inclined sleeper frame to the mounts on each corner of the play yard top rails.

Inclined Sleeper Setup

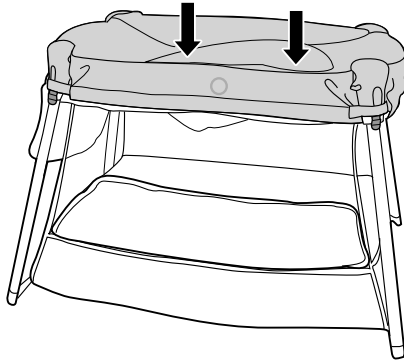

3

- Push down on the inclined sleeper frame to be sure it's secure.

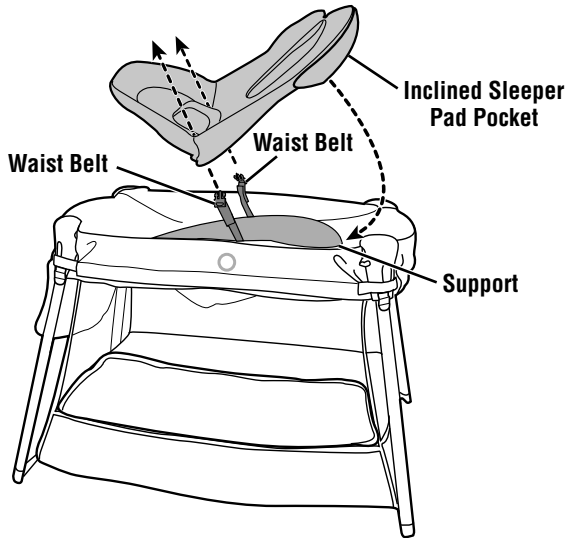

4

- Fit the waist belts through the slots in the inclined sleeper pad.
- Fit the pocket on the inclined sleeper pad onto the support on the inclined sleeper frame.
- Press the inclined sleeper pad edges onto the fasteners on the inclined sleeper frame.

Inclined Sleeper Use

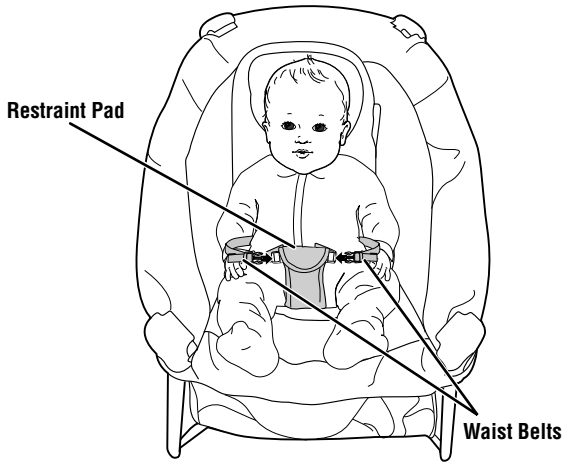

TOP VIEW

1

Securing Your Child

- Place your child in the inclined sleeper.
- Position the restraint pad between your child's legs.
- Fasten both waist belts to the restraint pad. Make sure you hear a “click” on both sides.
- Tighten each waist belt so that the restraint system is snug against your child. Please refer to the next section for instructions to tighten the waist belts.

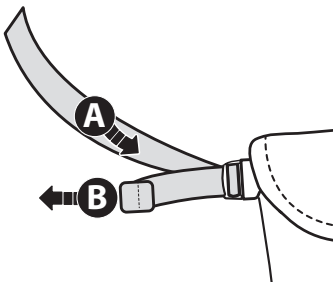

TIGHTEN

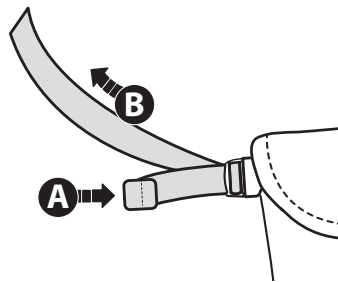

LOOSEN

2

- **To tighten the waist belts:** Feed the anchored end of the waist belt up through the buckle to form a loop **A**. Pull the free end of the waist belt **B**.
- **To loosen the waist belts:** Feed the free end of the waist belt up through the buckle to form a loop **A**. Enlarge the loop by pulling on the end of the loop toward the buckle. Pull the anchored end of the waist belt to shorten the free end of the waist belt **B**.
- Check to be sure the restraint system is securely attached by pulling it away from your child. The restraint system should remain attached.

Play Yard Use

REMOVE inclined sleeper frame

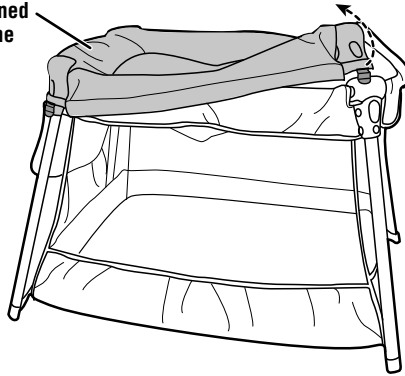

IMPORTANT! Remove the inclined sleeper for play yard use. Pull up to remove all four clips on the inclined sleeper frame to remove from the play yard mounts.

Changing Station Clutch

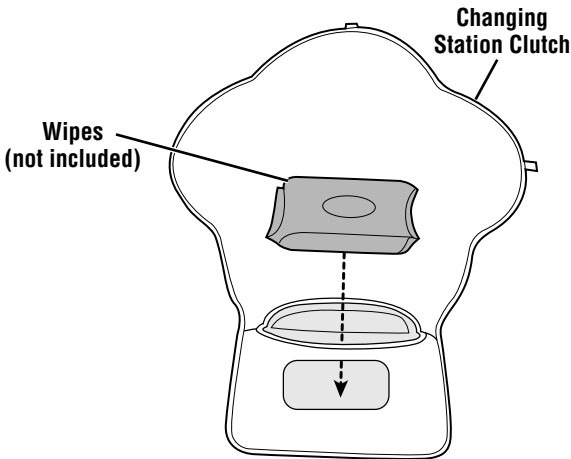

The changing station clutch easily folds and stores in the play yard pocket.

- Unfold the changing station clutch.
- Insert wipes (not included) into the pocket in the clutch.

Storage

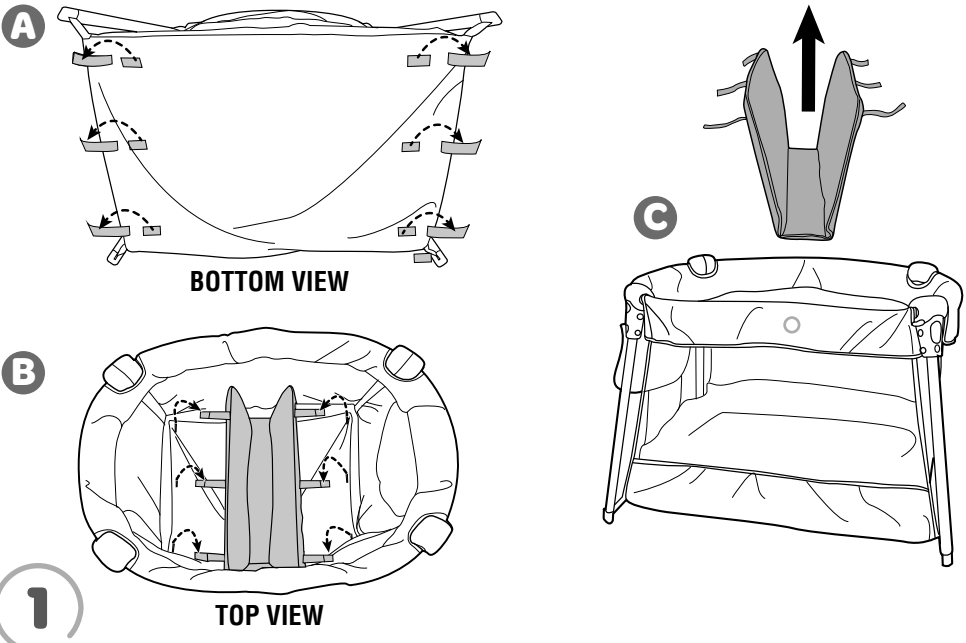

- Unfasten the mattress straps underneath the play yard floor **A**.
- Pull each strap up through the slot in the play yard floor **B**.
- Lift the ends of the mattress and remove from the play yard **C**.

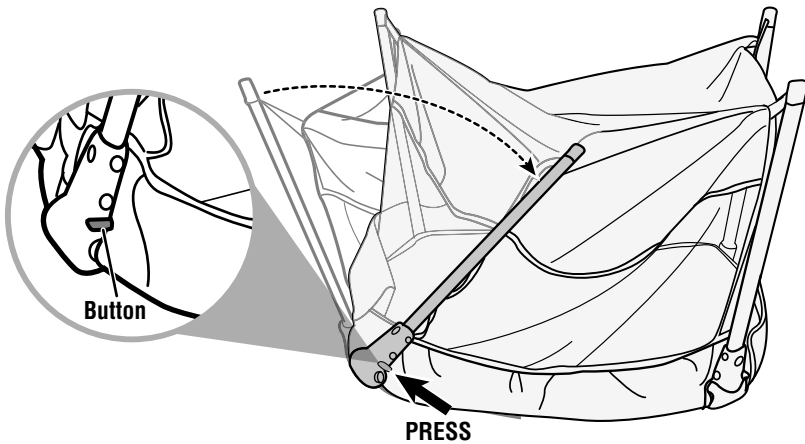

- Turn the play yard over.
- Press the button on a leg and lower the leg.
- Repeat this procedure to lower the remaining legs.

Storage

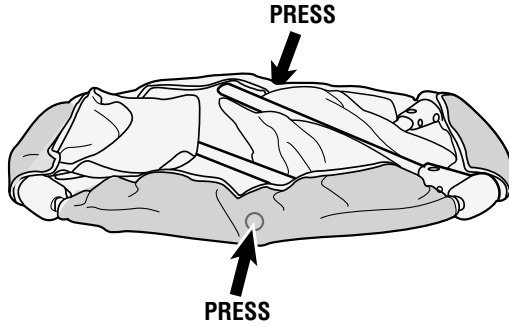

3

- Press the latches on each play yard top rail.

Hint: The latches are located under the circles (and inside the fabric) on the play yard top rails.

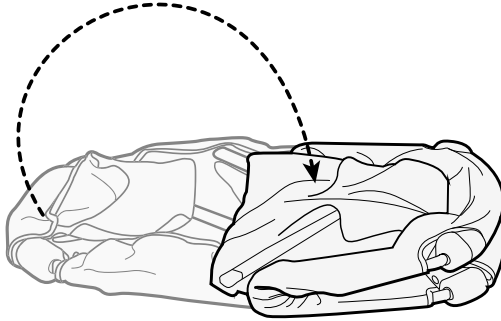

4

- Fold the play yard in half.

Storage

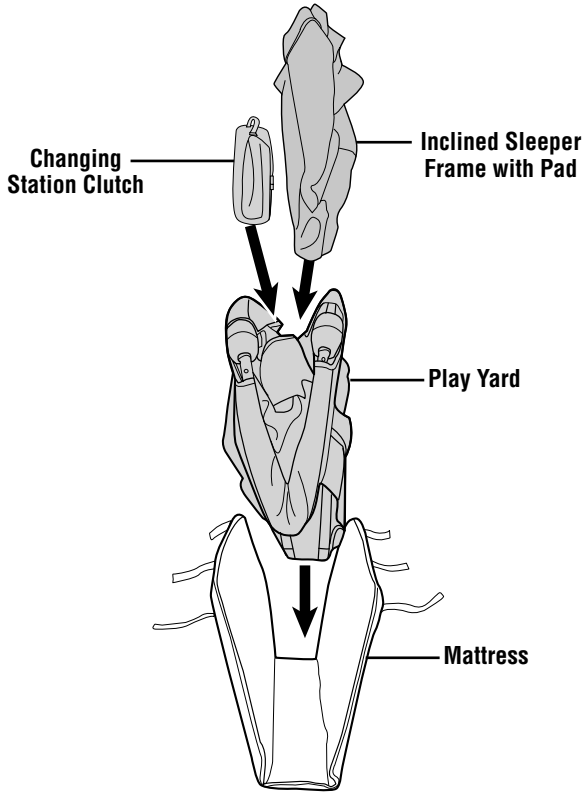

5

- Place the inclined sleeper frame with pad and the changing station clutch inside the play yard.
Hint: Tuck the fabric from the inclined sleeper frame into the center of the play yard.
- Fit the play yard inside the mattress.

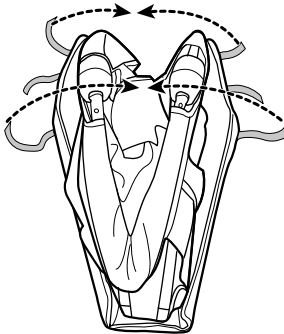

6

- Fasten the straps on the mattress.

Storage

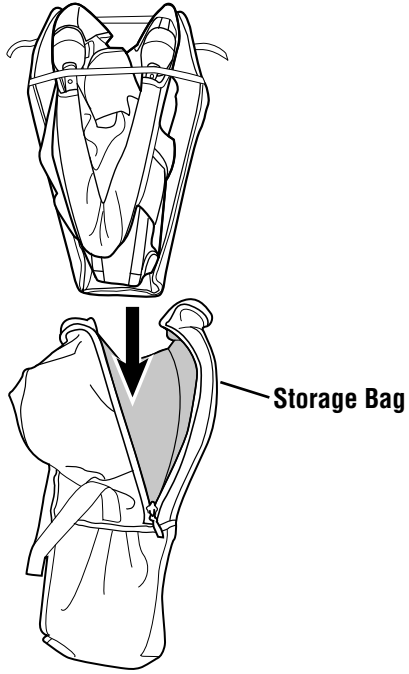

7

- Place the mattress with play yard, inclined sleeper and pad and changing station clutch inside the storage bag.
- Zip the storage bag closed.

Preventing Baby's Head from Flattening



Pediatricians and child health organizations agree that healthy babies should be placed on their backs to sleep for naps and at nighttime, to reduce the risk of Sudden Infant Death Syndrome (SIDS). But babies who are always on their backs can sometimes develop flat spots on their head (plagiocephaly). Most cases of positional plagiocephaly can be prevented (and sometimes corrected) by repositioning your baby to relieve pressure on the back of the head. Here are some tips and techniques from the experts to keep in mind as you care for your baby:

- Change the location of your baby's sleeper or crib in the room, so she has to look in different directions to see the door, or the window, or interesting things going on around her.
- When your baby is awake, provide opportunities for adult-supervised "tummy time" play. Playing on his tummy helps take the pressure off the back of his head, which will help prevent flat spots from developing. Tummy time play also helps your baby's head, neck and shoulder muscles get stronger as part of normal development.
- Try tummy time two or three times a day, for short periods of time, until your baby gets used to being on her tummy. Once your baby begins to enjoy this position, try longer periods of time or increase the frequency of tummy time play.
- Help your baby avoid resting his head in the same position all the time by frequently changing the direction he lies in the crib. For example, have your baby's feet point toward one end of the crib for a few days, and then change the position so his feet point toward the other end of the crib. This will encourage your baby to turn and look in different directions.
- Try to minimize the amount of time your baby spends in car seats, carriers and bouncy seats while awake.
- Lastly, make sure you enjoy lots of "cuddle time" with your baby by holding her upright over your shoulder.

For additional information on positional plagiocephaly and the benefits of tummy time play for your baby, speak with your pediatrician or family physician.

National Institute of Health (NIH) Eunice Kennedy Shriver National Institute of Child Health and Human Development