

4 TO PLAY (CONTD.)

C. Smash...

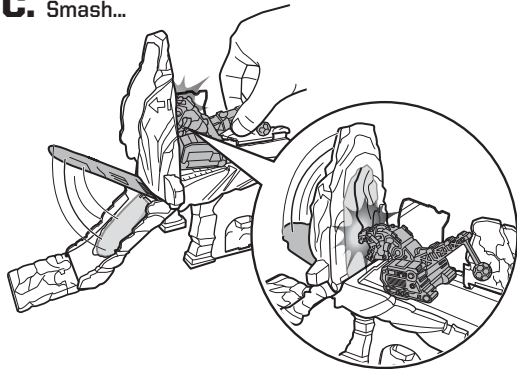

D. ...and slide!

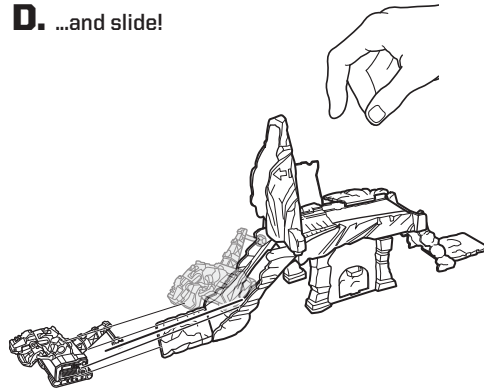

E. Smash and collapse the other wall!

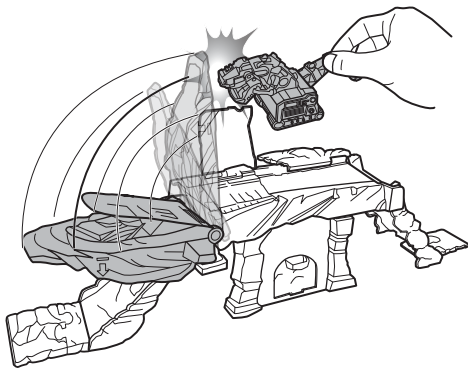

F. Find and reveal the hidden ore.

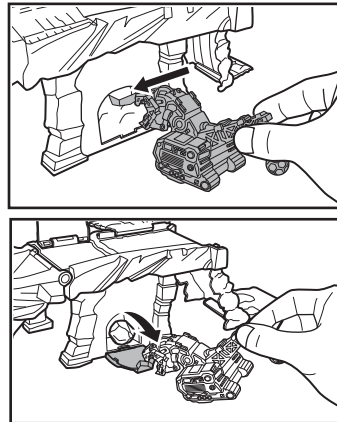

5 MORE WAYS TO PLAY

CONNECTS WITH OTHER DINOTRUX PLAYSETS!

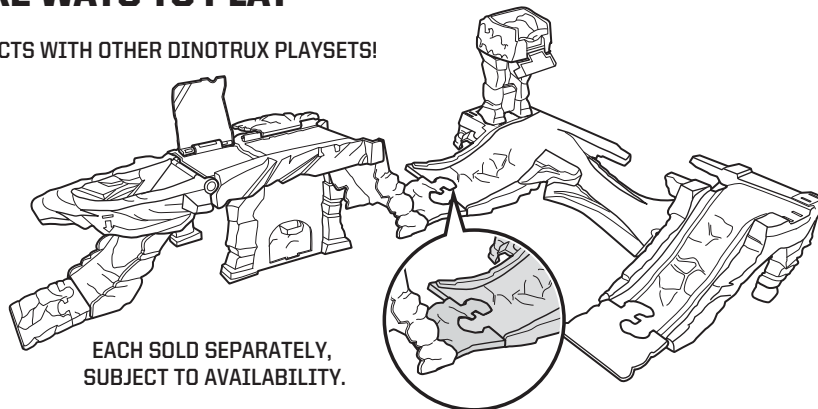

EACH SOLD SEPARATELY,
SUBJECT TO AVAILABILITY.

SMASH & SLIDE CONSTRUCTION SITE

DINOTRUX INSTRUCTIONS

3+

Please keep these instructions for future reference as they contain important information.

CONTENTS

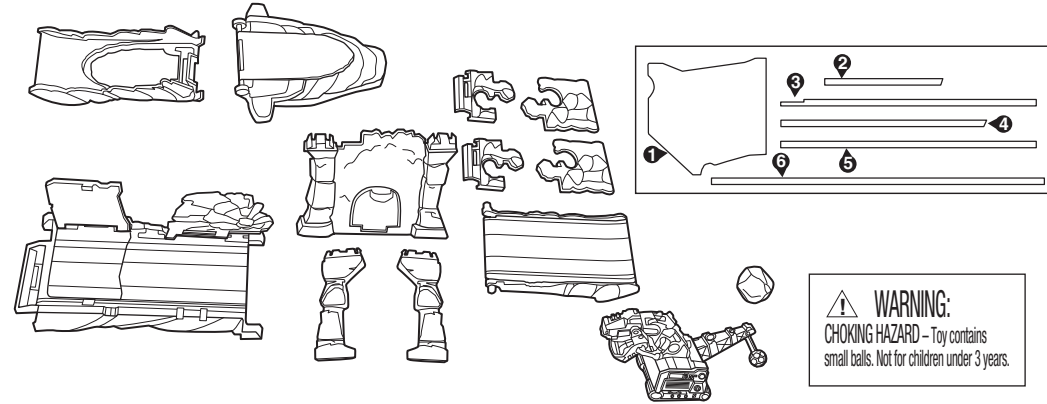

WARNING:
CHOKING HAZARD - Toy contains
small balls. Not for children under 3 years.

1 APPLY LABELS

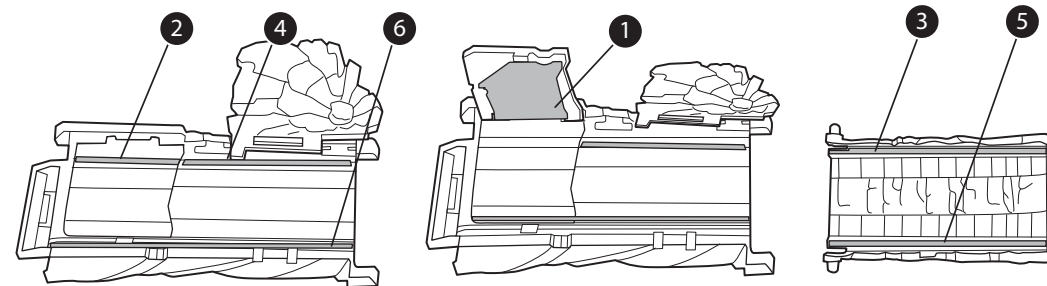

©2015 Mattel. All Rights Reserved. Mattel, Inc., 636 Girard Avenue, East Aurora, NY 14052, U.S.A. Consumer Services 1-800-524-8697. Mattel U.K. Ltd., Vanwall Business Park, Maidenhead SL6 4UB. Helpline 01628 500303. Mattel Australia Pty., Ltd., Richmond, Victoria. 3121. Consumer Advisory Service - 1300 135 312. Mattel East Asia Ltd., Room 503-09, North Tower, World Finance Centre, Harbour City, Tsimshatsui, HK, China. Tel.: (852) 3185-6500. Diimport & Diedarkan Oleh: Mattel Southeast Asia Pte. Ltd., No 19-1, Tower 3 Avenue 7, Bangsar South City, No 8, Jalan Kerinchi, 59200 Kuala Lumpur, Malaysia. Tel: 03-78803817, Fax: 03-78803867.

Asst. CJV82
CJV83-0970
1100662725_DOM

Dinotrux © 2015 DreamWorks Animation LLC. All Rights Reserved.



2 ASSEMBLY

A.

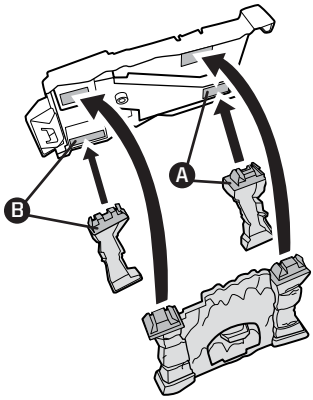

B.

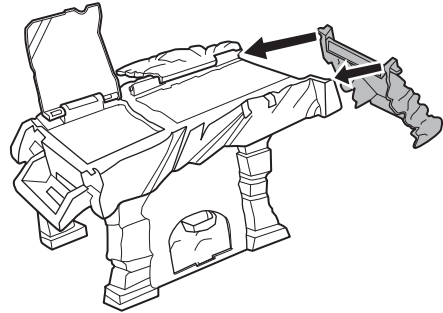

C.

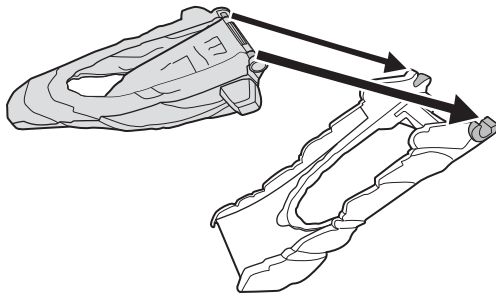

D.

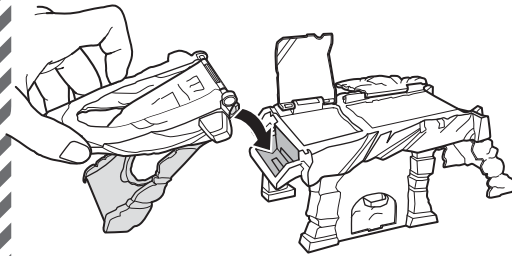

E.

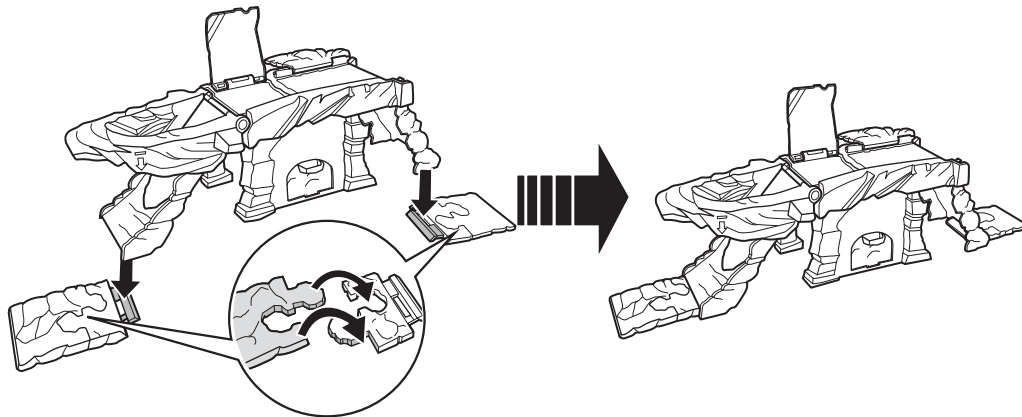

3 SET UP

A. Open the secret cave.

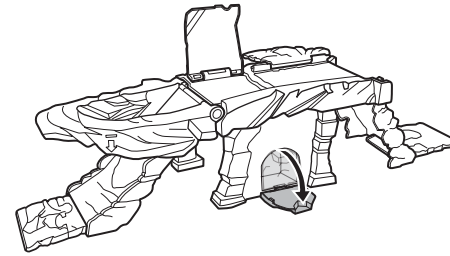

B. Hide and store the ore!

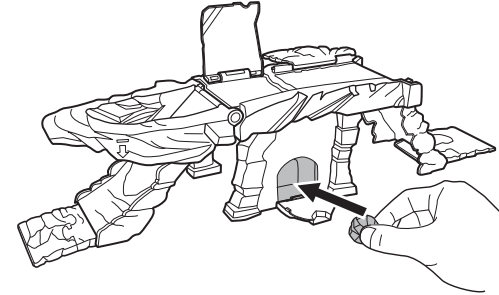

C. Raise the walls.

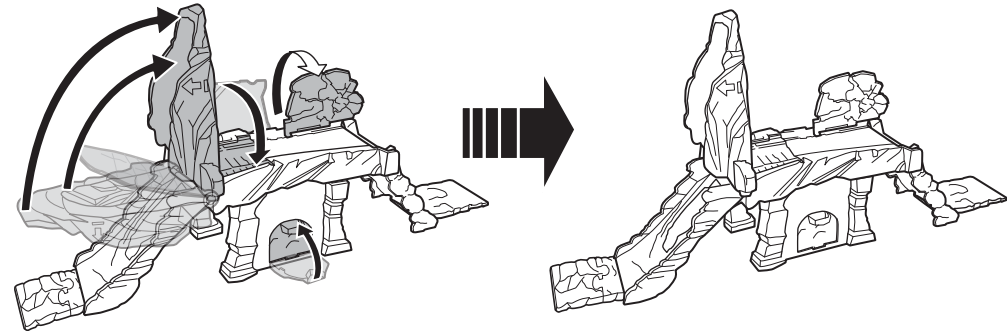

4 TO PLAY

A. Push Ty Rux up the slope.

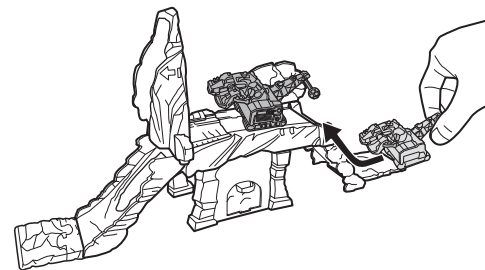

B. Smash the wall to reveal Rewvit's plans!

