

# HALO

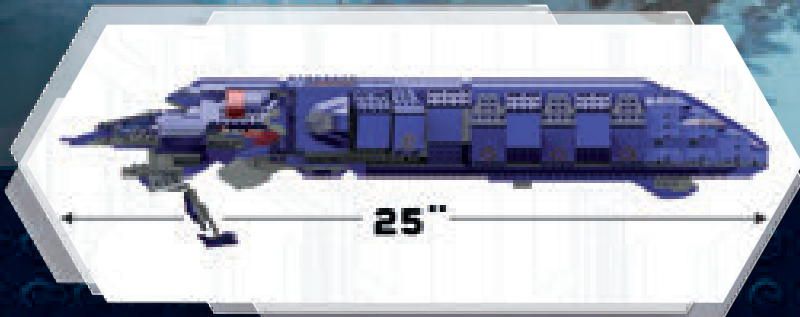

Covenant Spirit Dropship | Dropship Spirit Covenant | Nave Covenant  
Veículo Espírito Covenant | Covenant Spirit Dropship Zestaw | Разведывательная машина "Призрак"









**SECTION • SECCIÓN • ABSCHNITT**  
**SECTIE • SEZIONE • SECÇÃO**



1

4-23



1

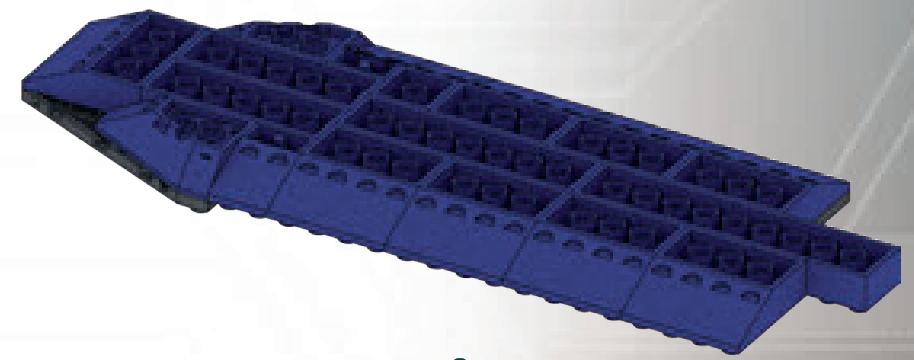
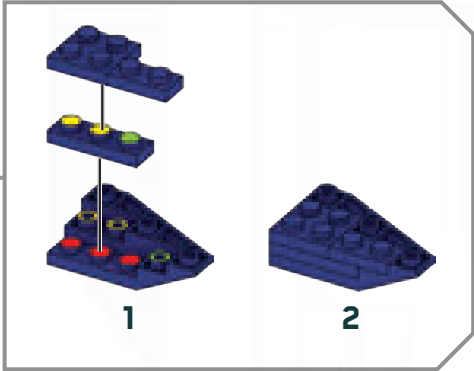
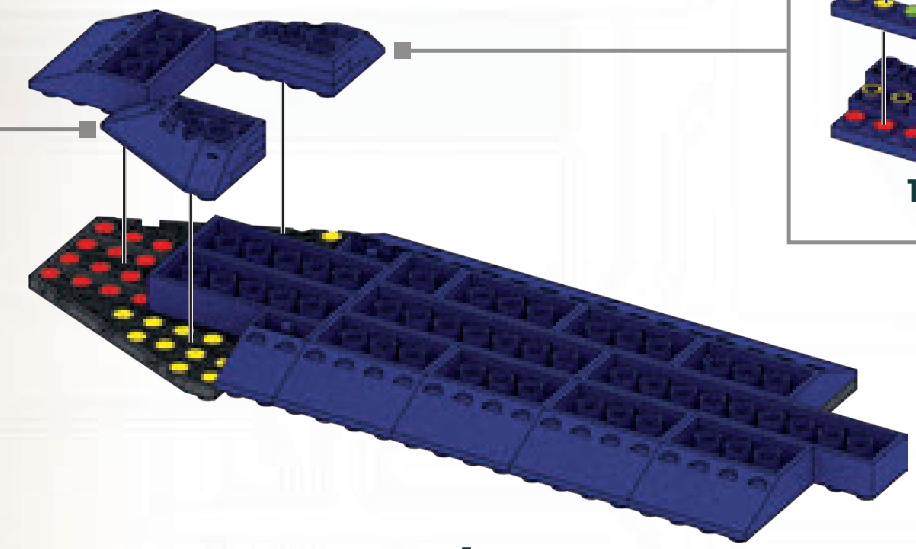
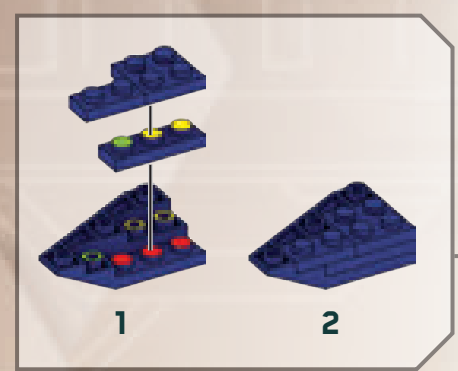
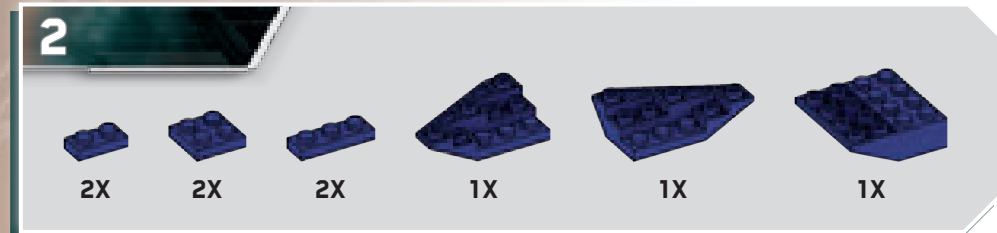
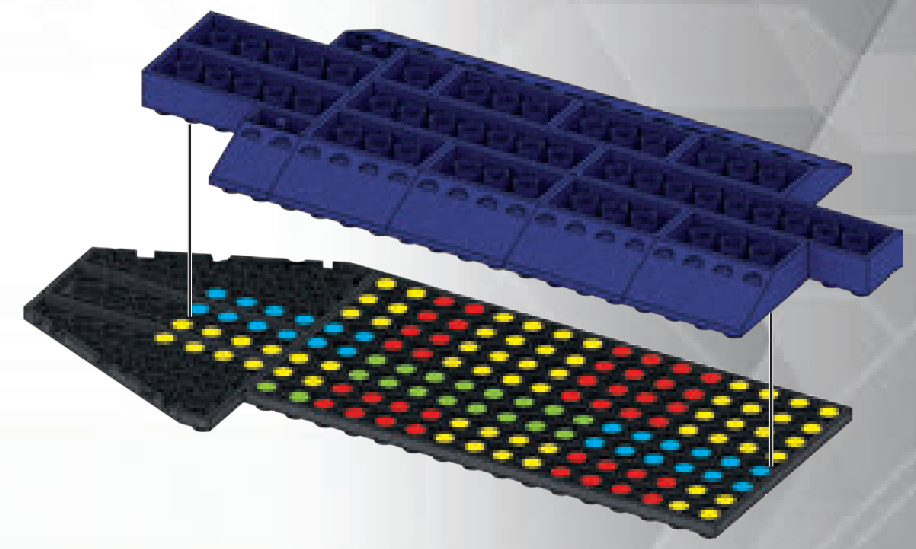
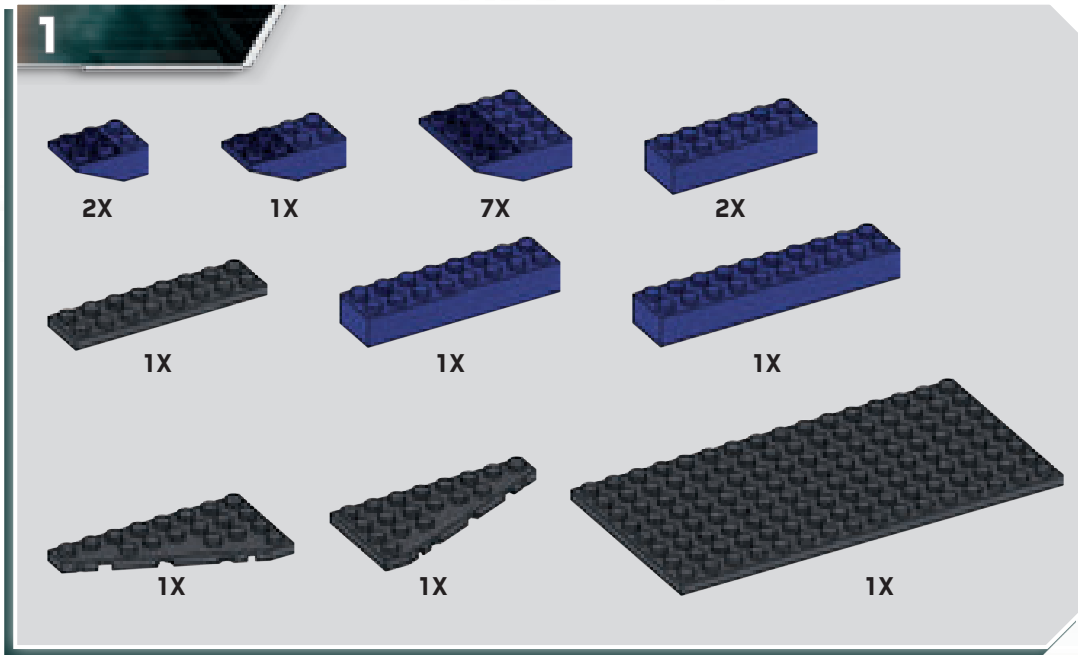

6

**3**

3X 1X 1X

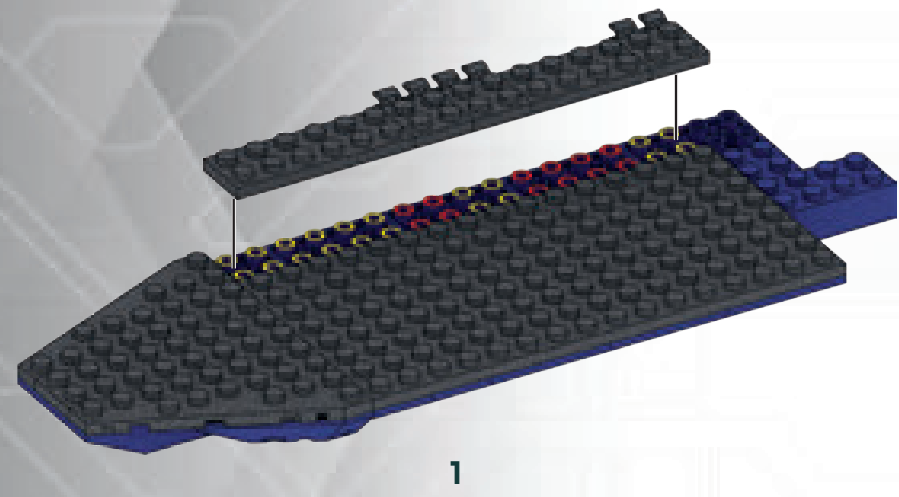

**4**

2X 7X 1X

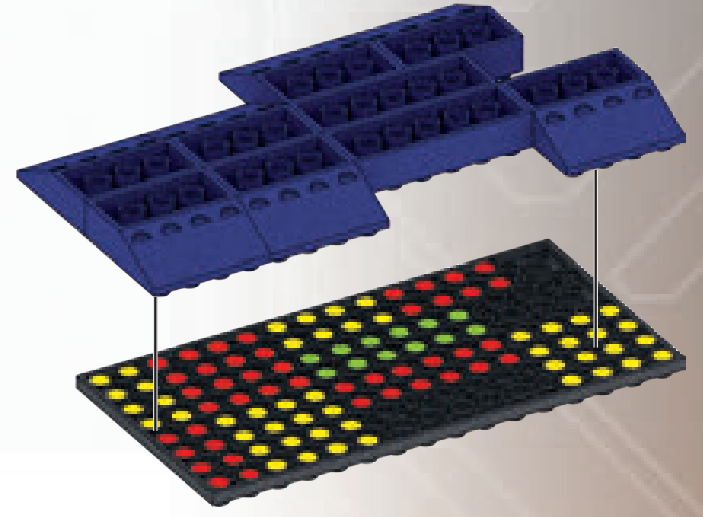

**5**

1X 1X 3X 1X 2X 2X

1 2 1 2 1 2 3

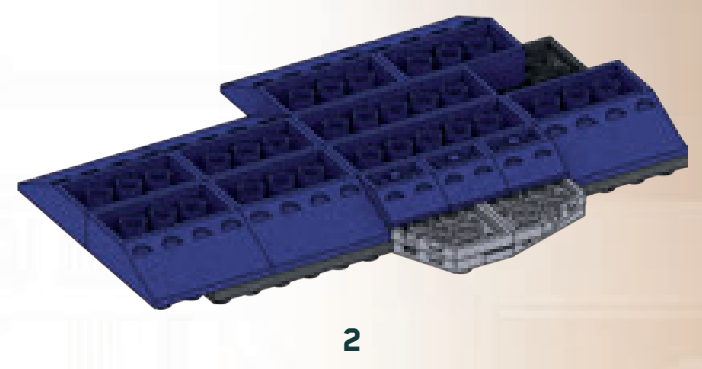
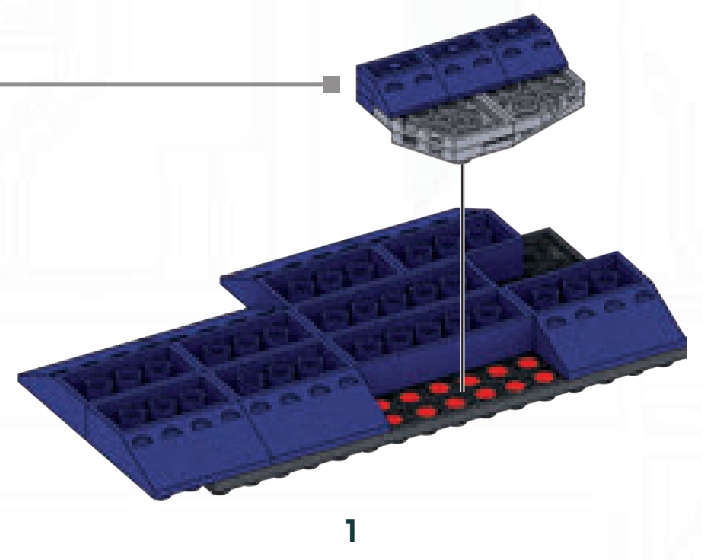

6

1

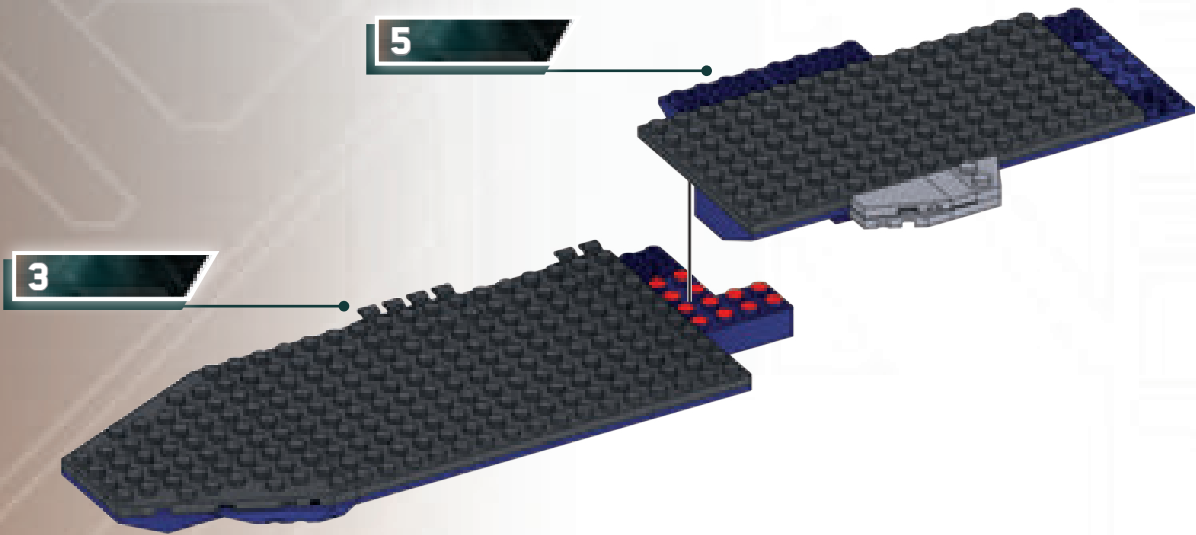

7

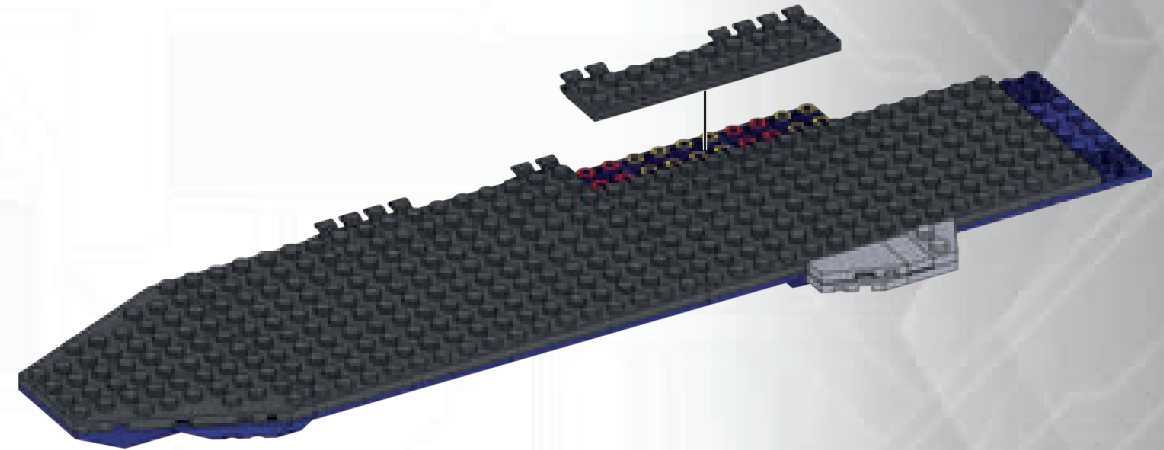

8

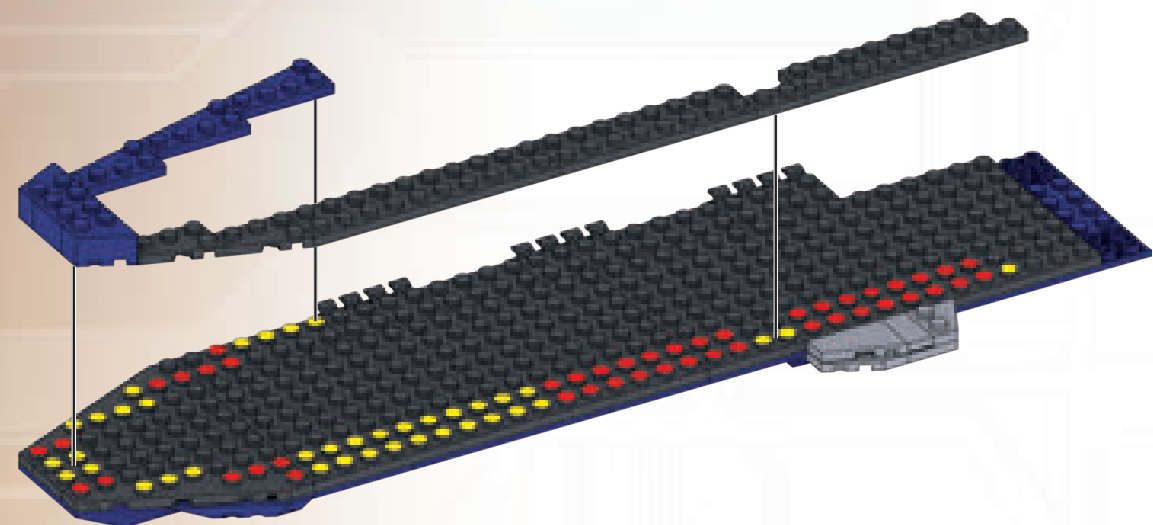

9

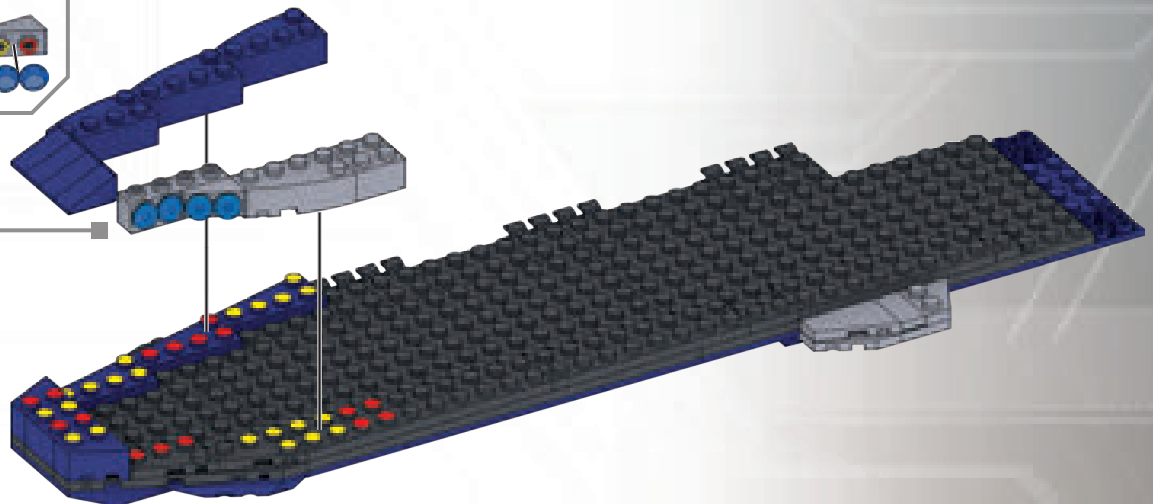
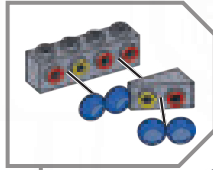
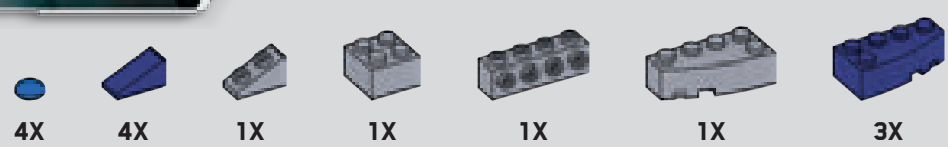

8



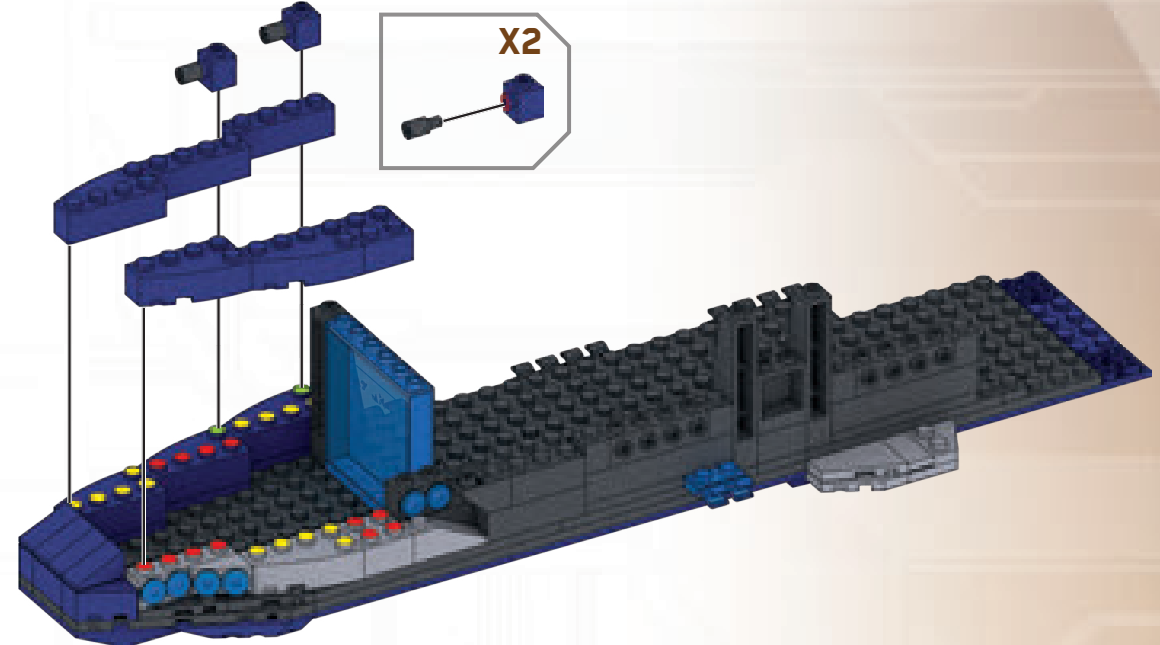
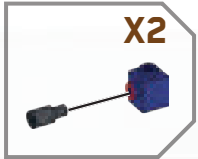
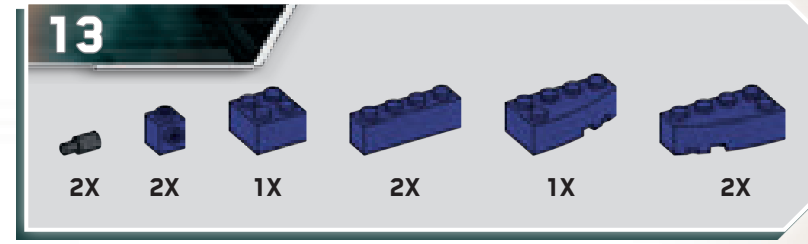
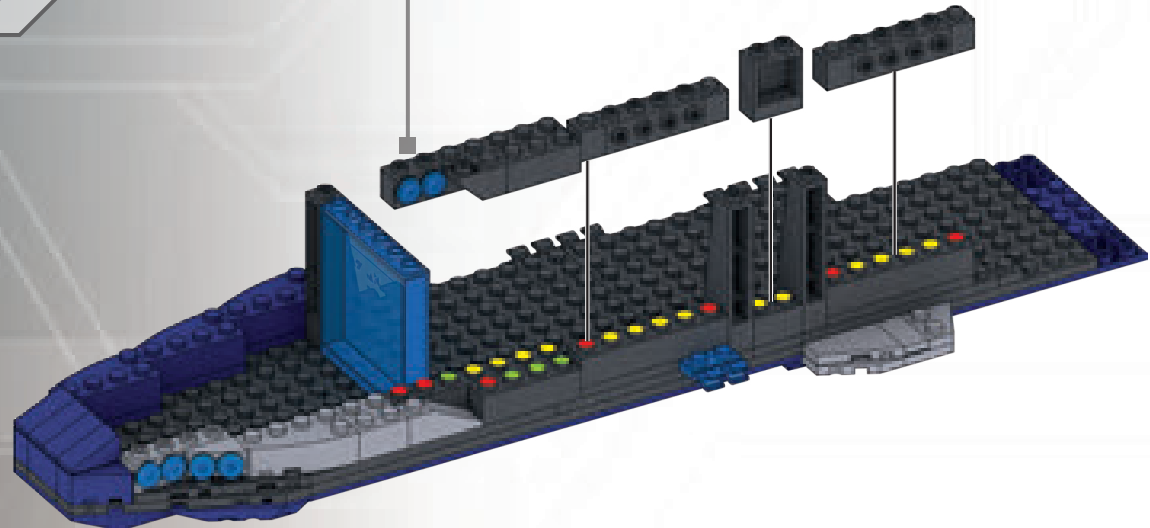
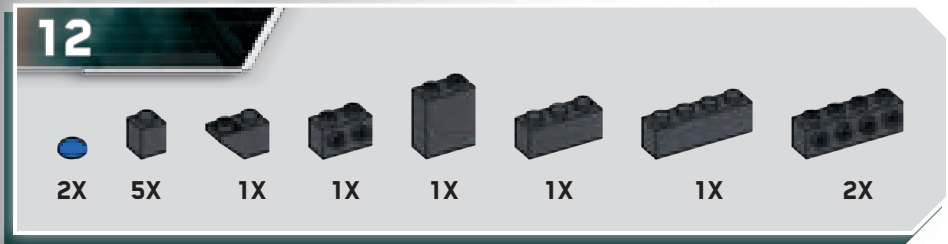
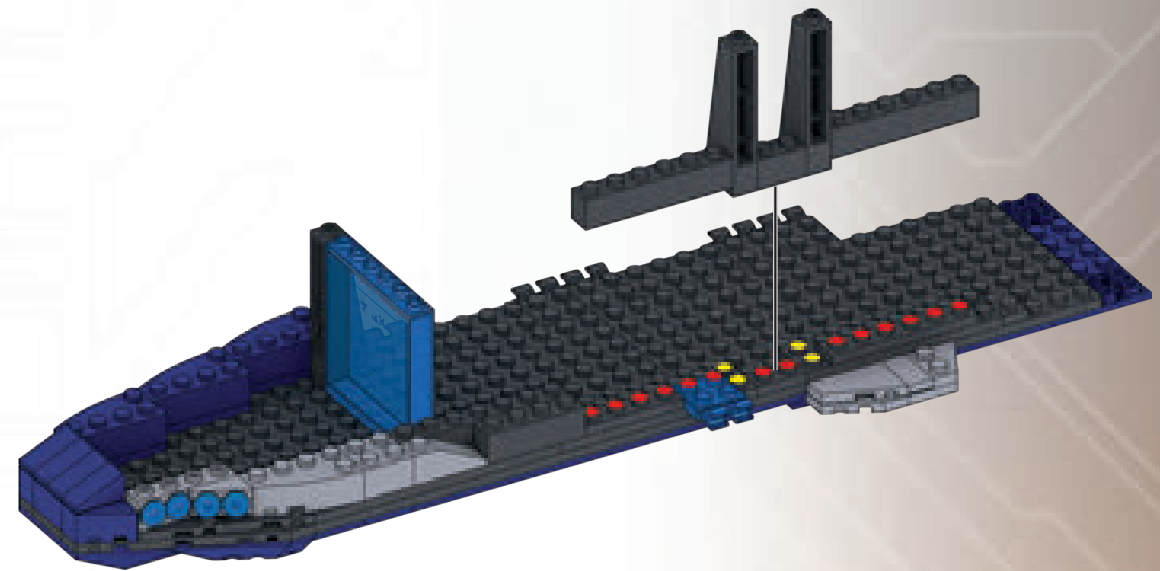
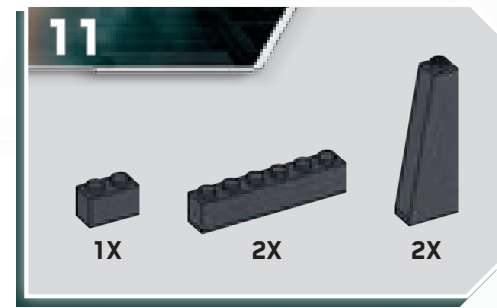
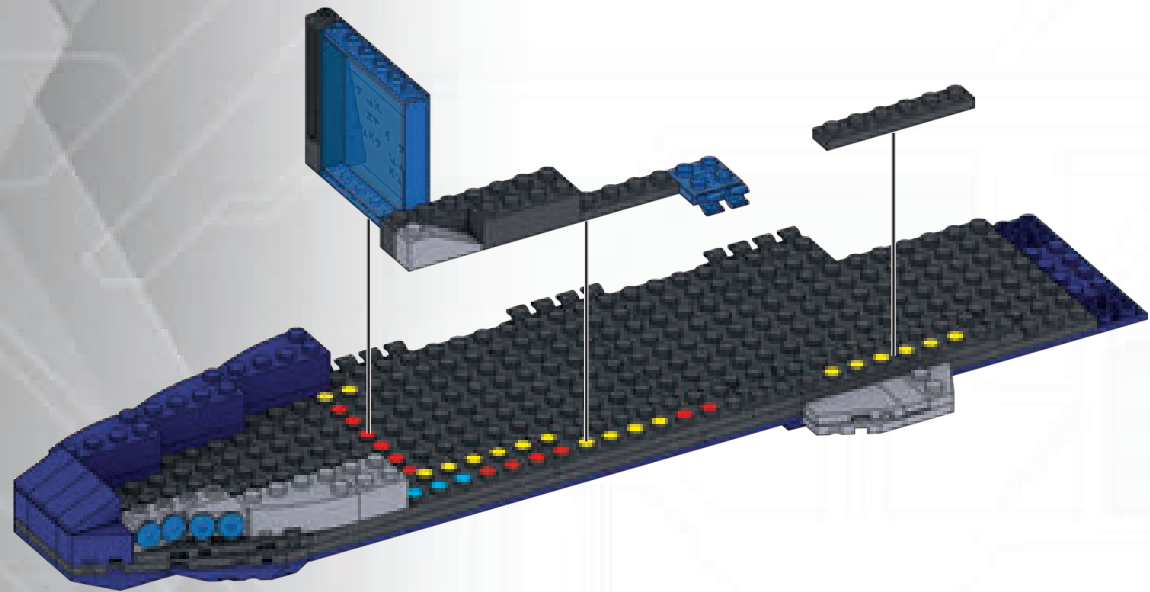
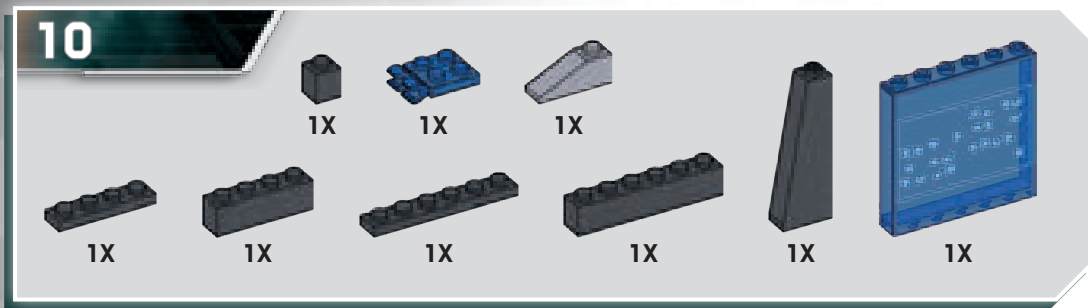

14

- 2X 
- 1X 
- 1X 
- 1X 
- 1X 
- 4X 

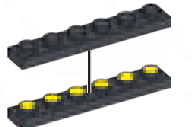
- X2 

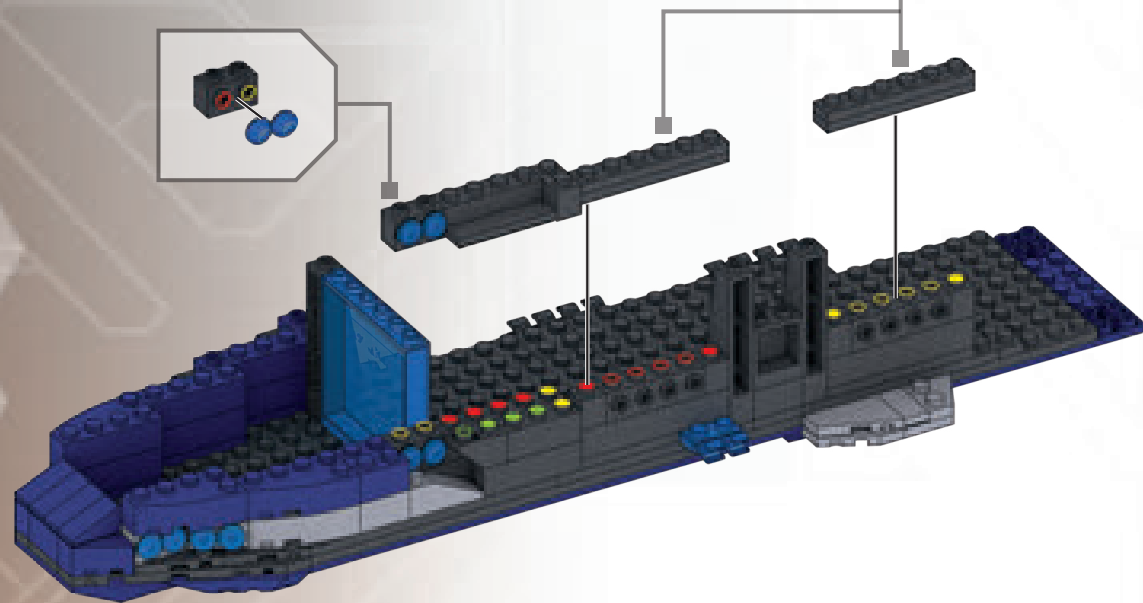

15

- 1X 
- 1X 
- 1X 
- 1X 
- 2X 

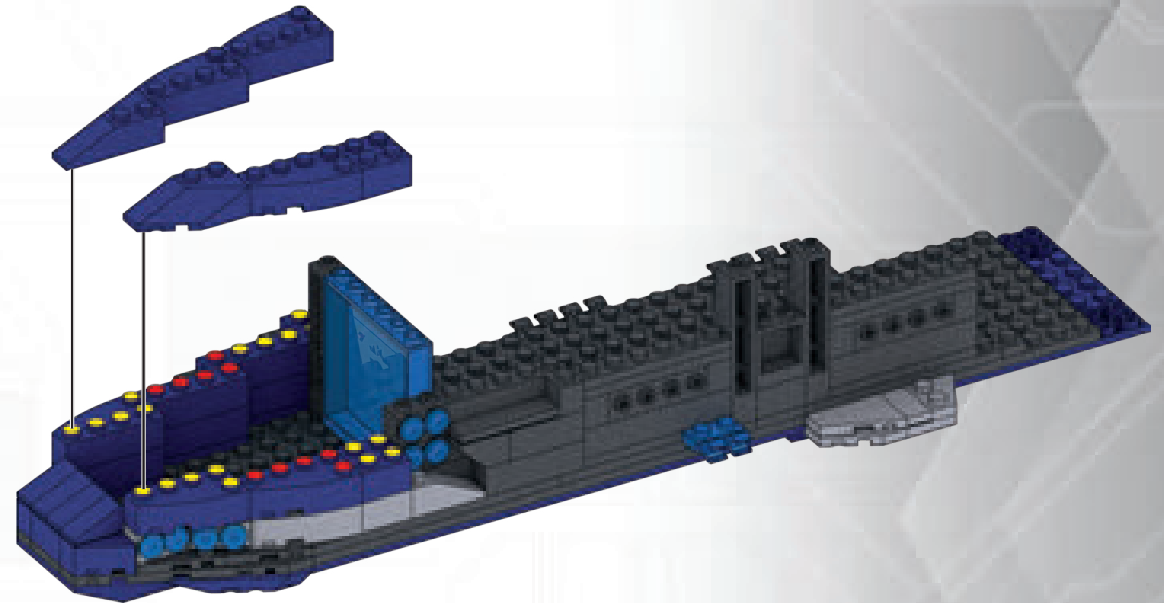





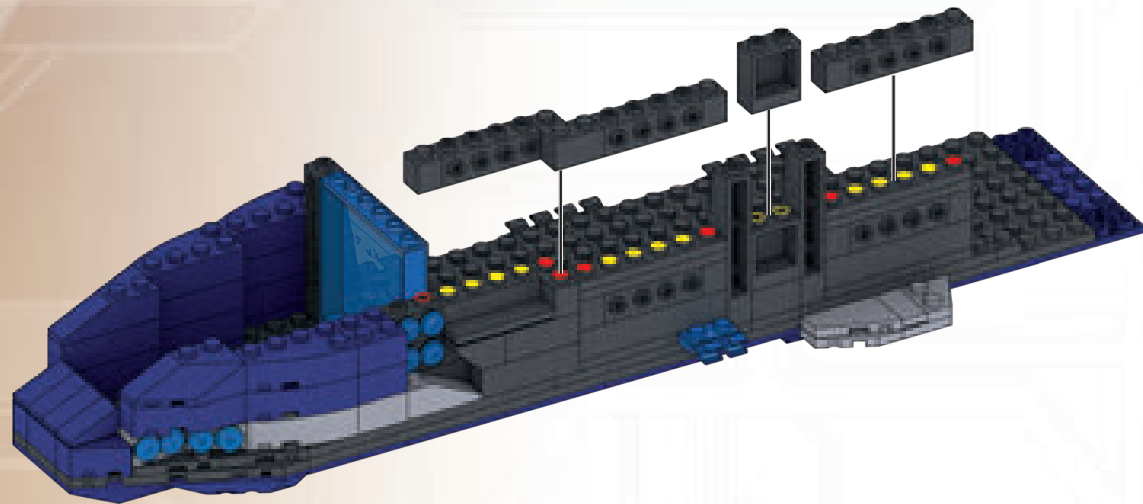

16

- 4X 
- 1X 
- 1X 
- 3X 

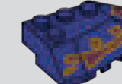

17

- 2X 
- 1X 
- 2X 
- 1X 
- 1X 
- 1X 

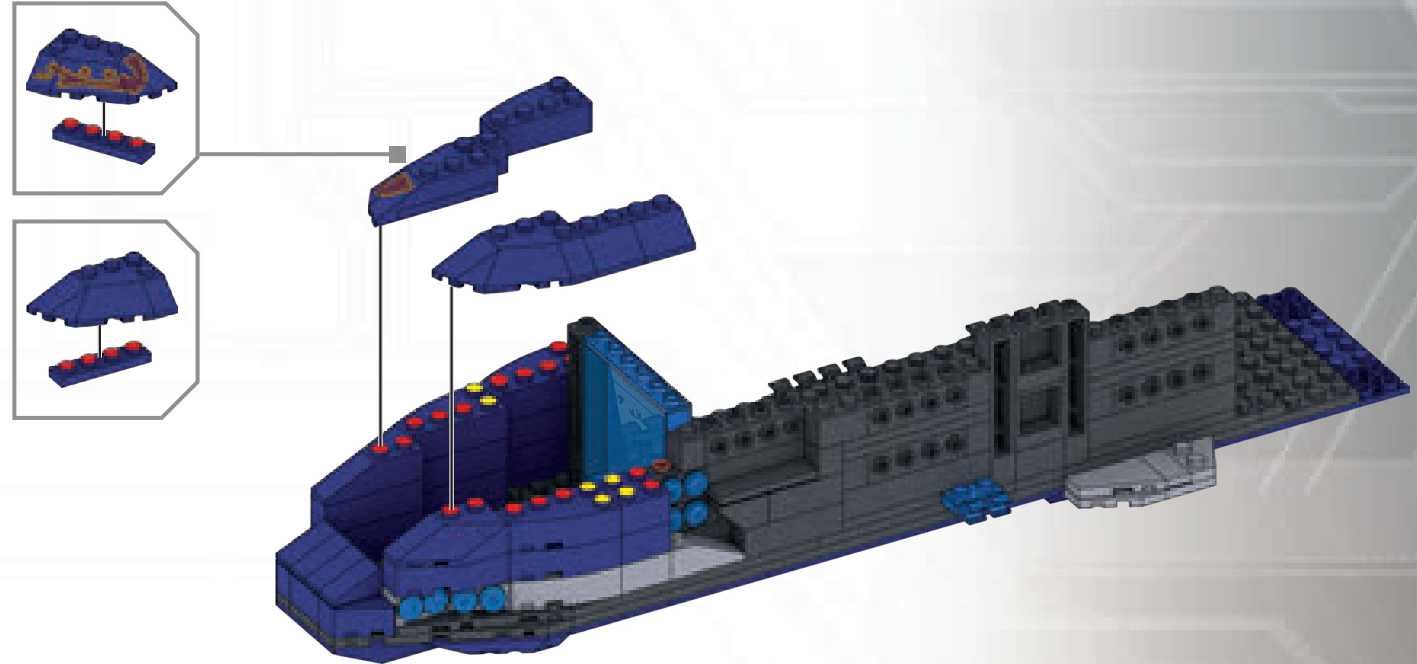

**18**

1X 1X 1X  
2X 1X

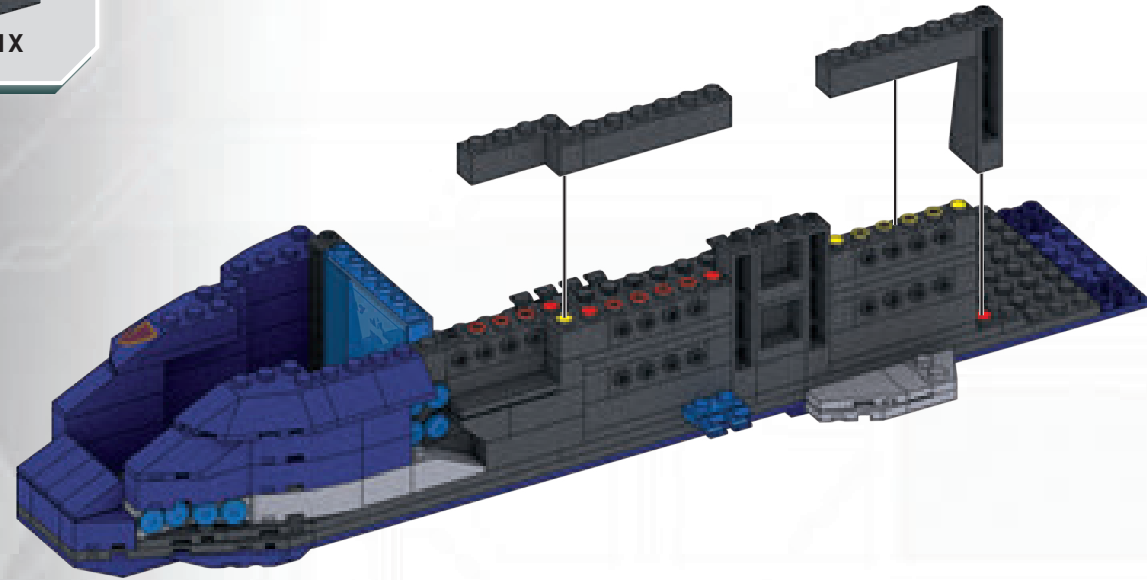

**19**

4X 1X 1X 1X 1X 1X

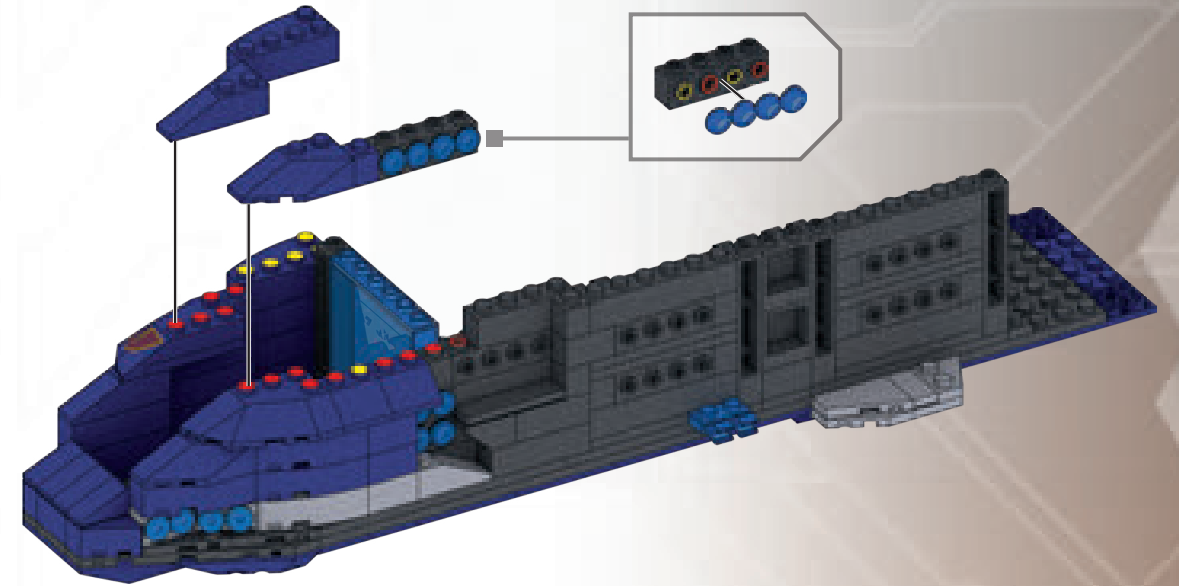

**20**

2X 1X 1X 1X 1X

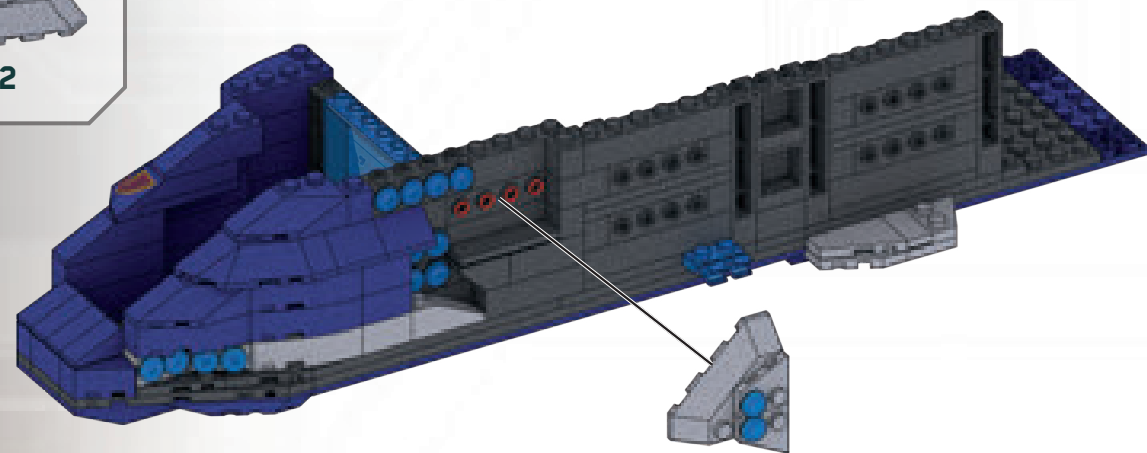
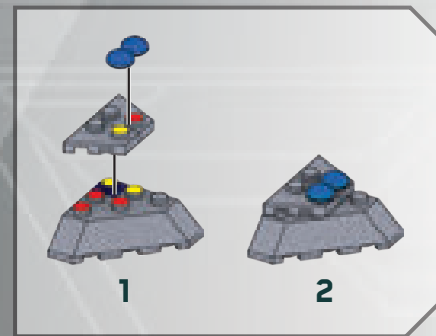

**21**

2X 1X

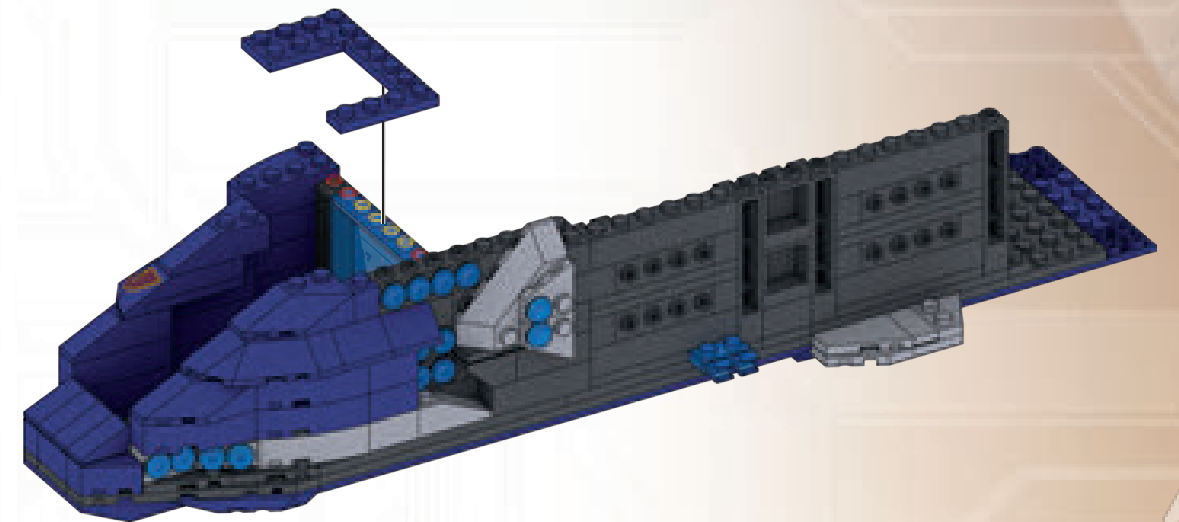

22

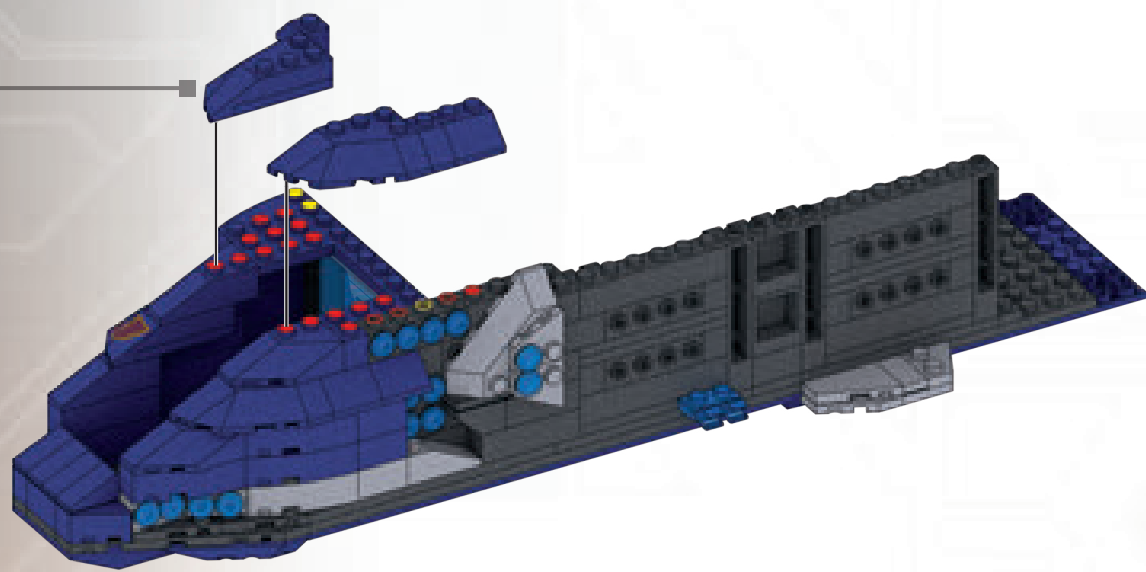
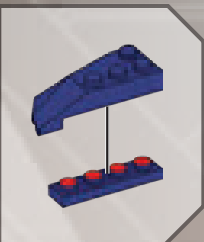
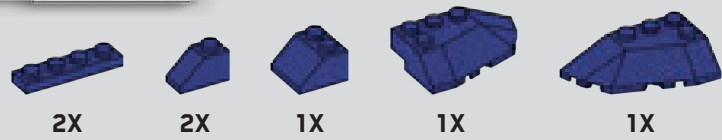

1

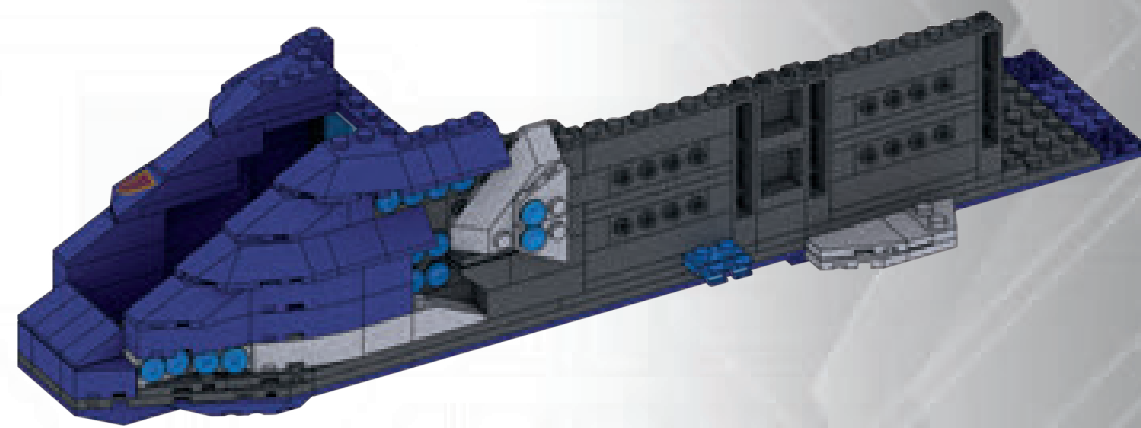

2

23

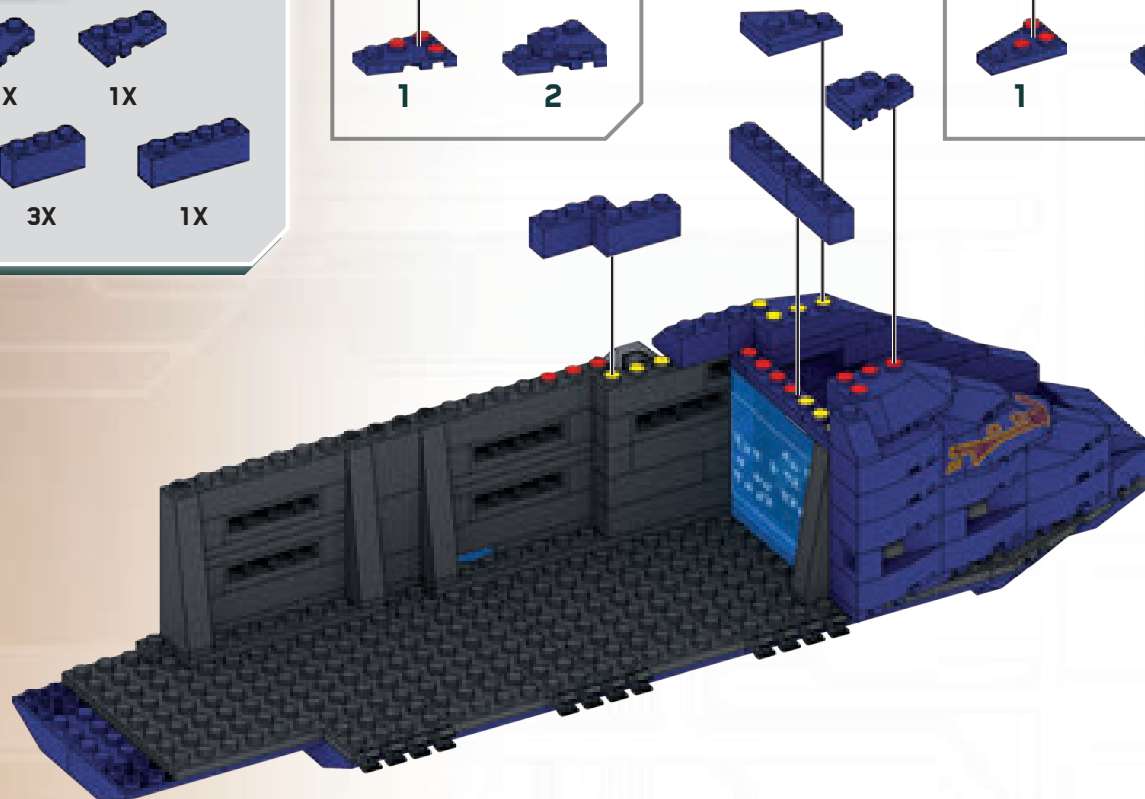
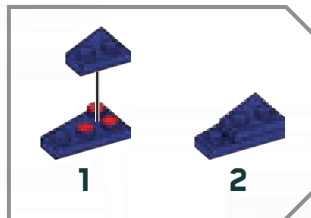
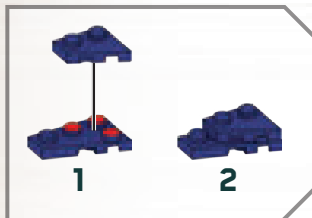
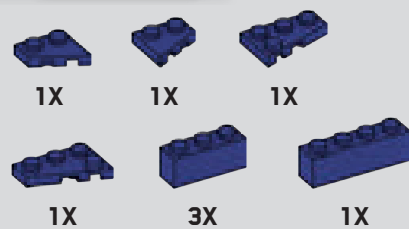

24

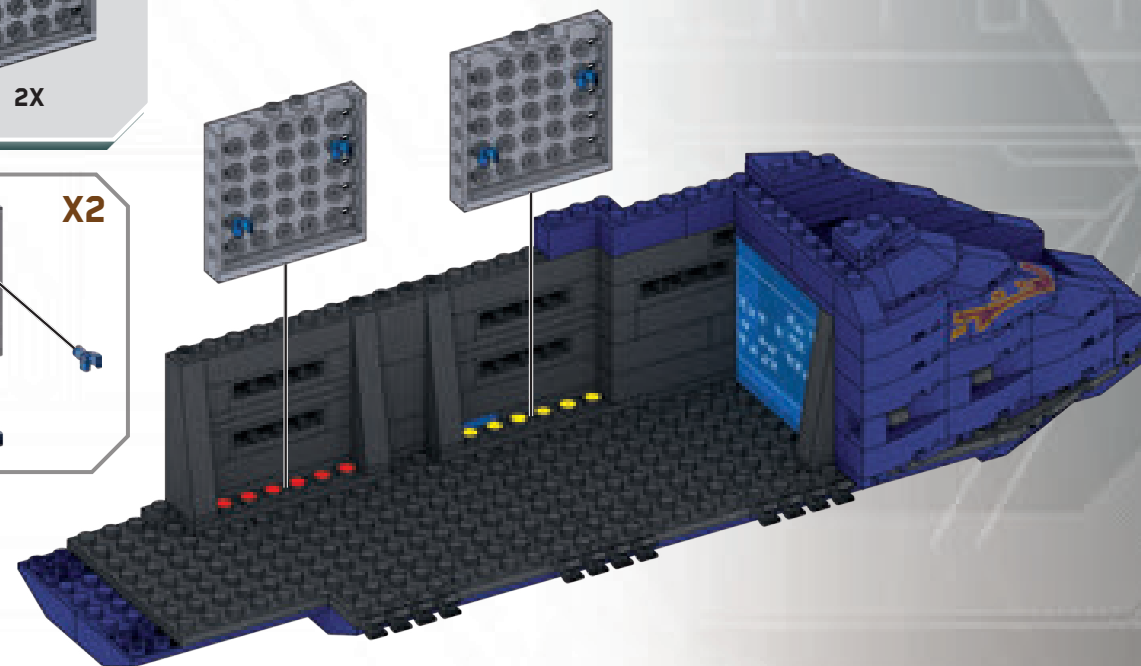
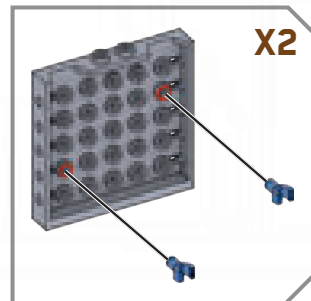
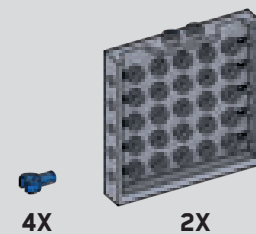

**25**

2X      1X

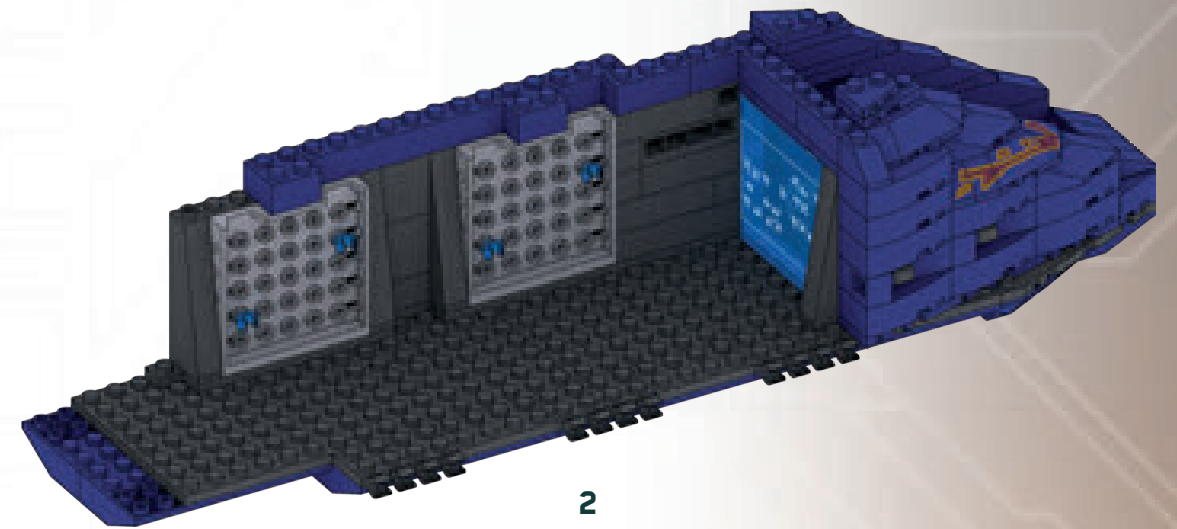
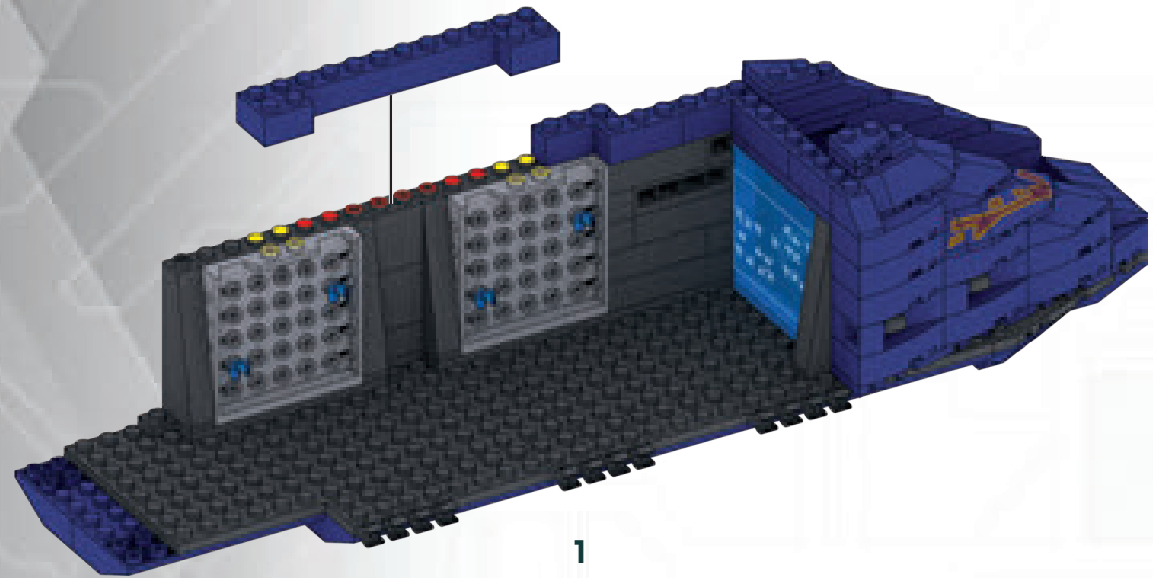

**26**

1X      2X

1X      1X

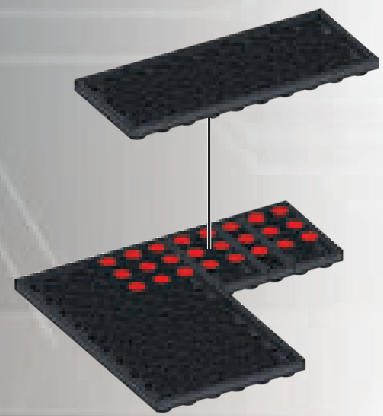

**27**

1X      1X      1X

1X      1X      1X

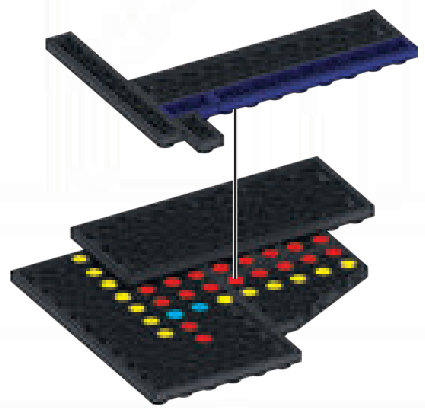

**28**

1X

1X



29

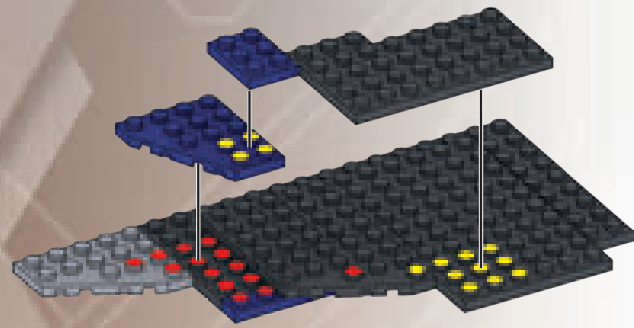
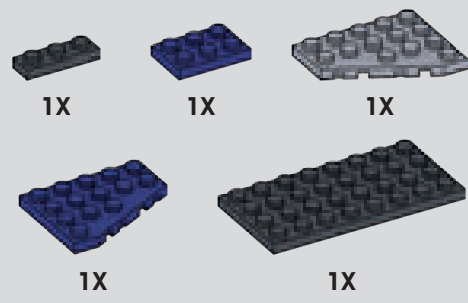

30

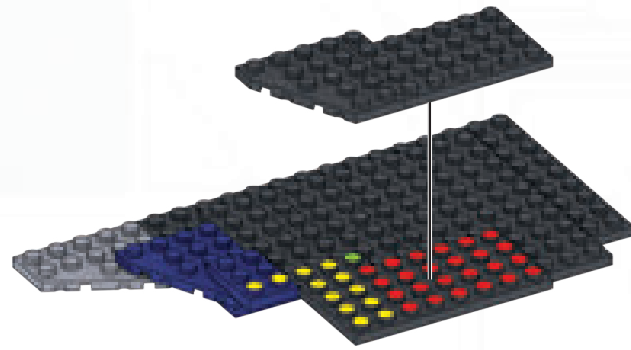

31

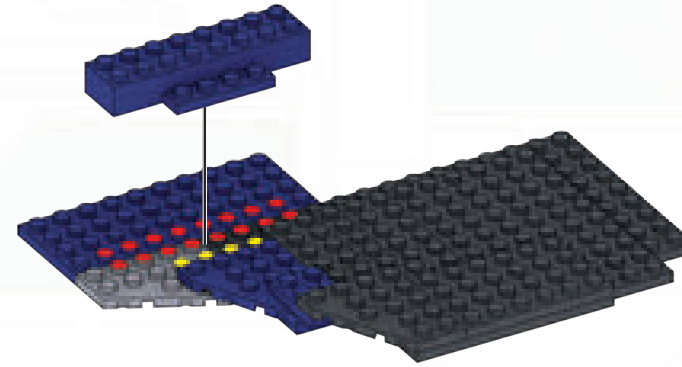
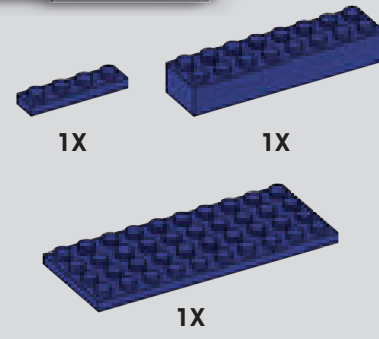

32

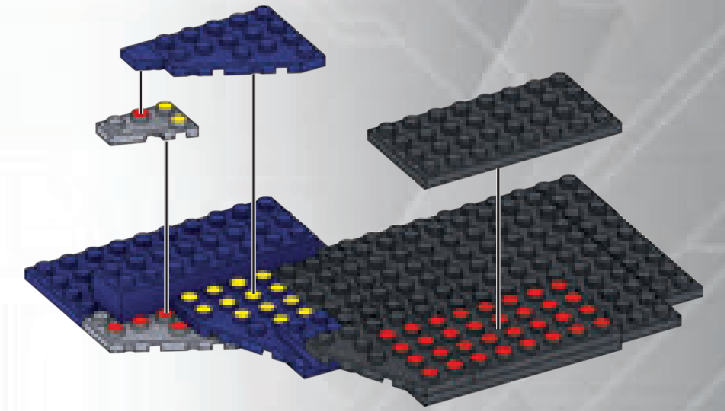
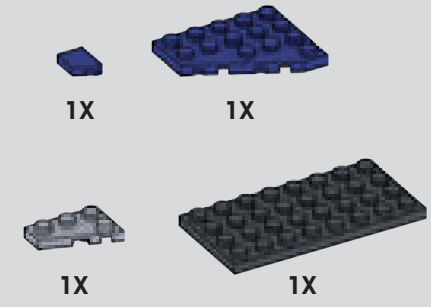

33

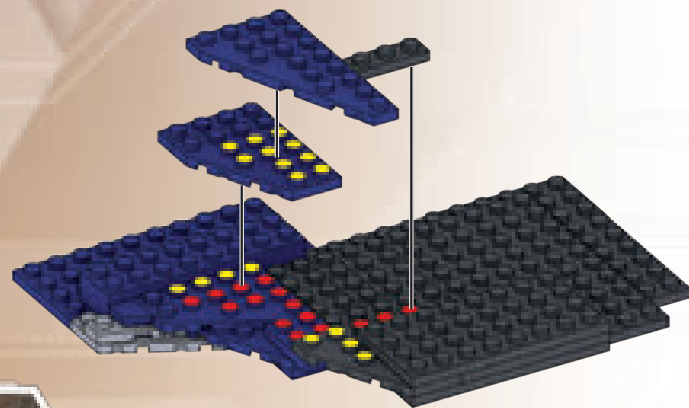

34

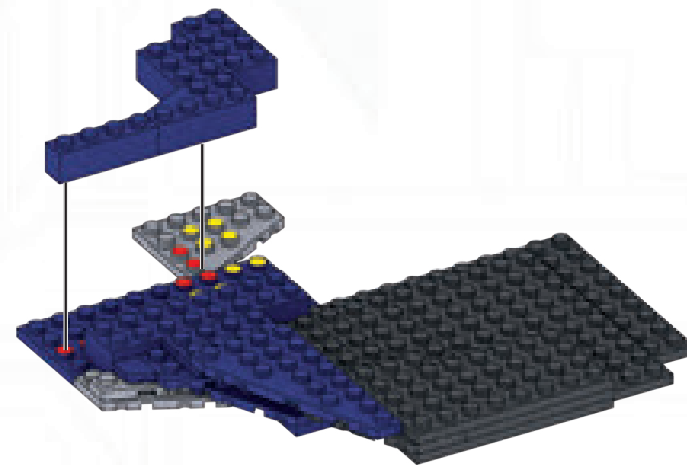
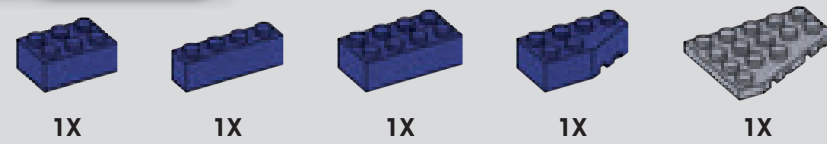

1

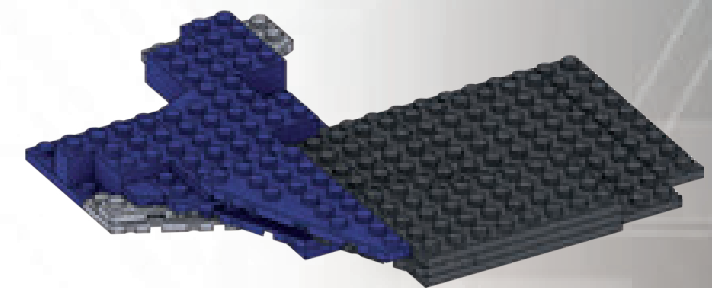

2

35

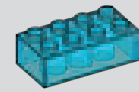

1X



1X



1X

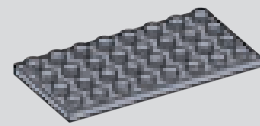

1X

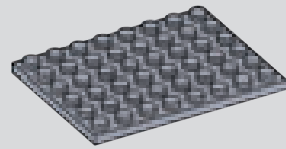

1X

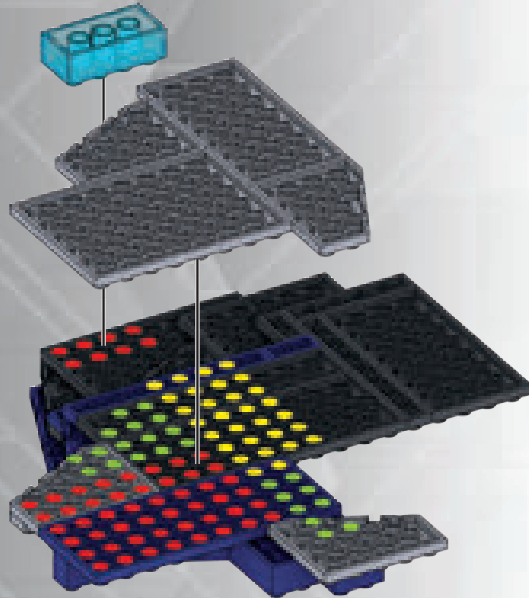

1

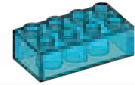

Place temporary piece  
 Placer la pièce temporaire  
 Colocar la pieza provisional  
 Colocar a peça temporária  
 Posizionare il pezzo provvisorio  
 Das vorübergehend benötigte Teil platzieren  
 Umieść tymczasowy element  
 Plaats tijdelijk deel  
 Поместите временную деталь  
 Placer midlertidigt stykke.  
 Placera temporär del  
 Plasser midlertidig del  
 Aseta väliaikainen osa  
 Τοποθετήστε το προσωρινό κομμάτι  
 Geçici parçayı yerleştirin  
 放置临时件  
 暫定ピースを配置してください  
 ضع القطعة المؤقتة

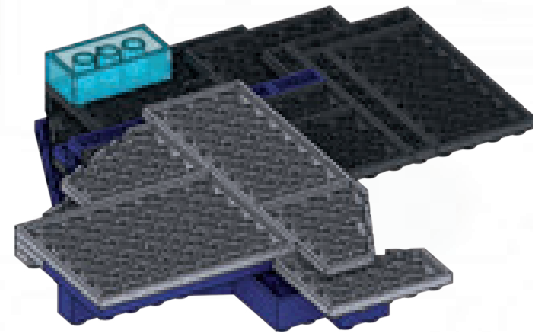

2

36



1X



1X



1X

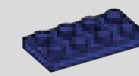

1X

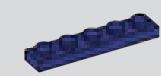

1X

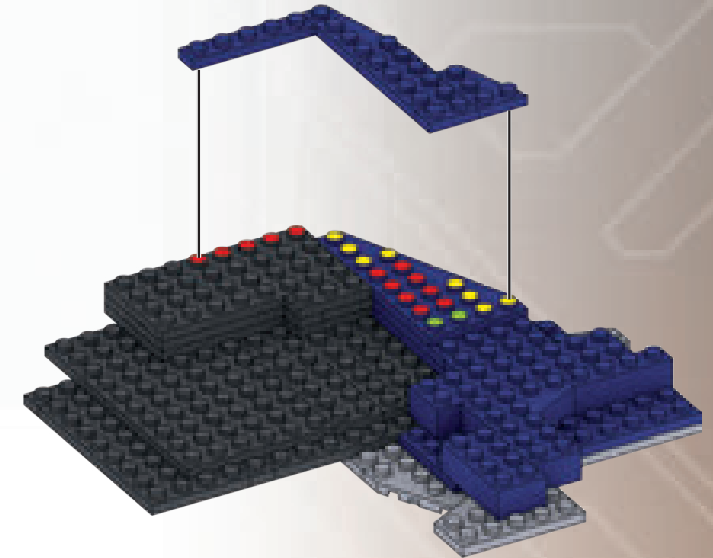

37



1X



2X



1X

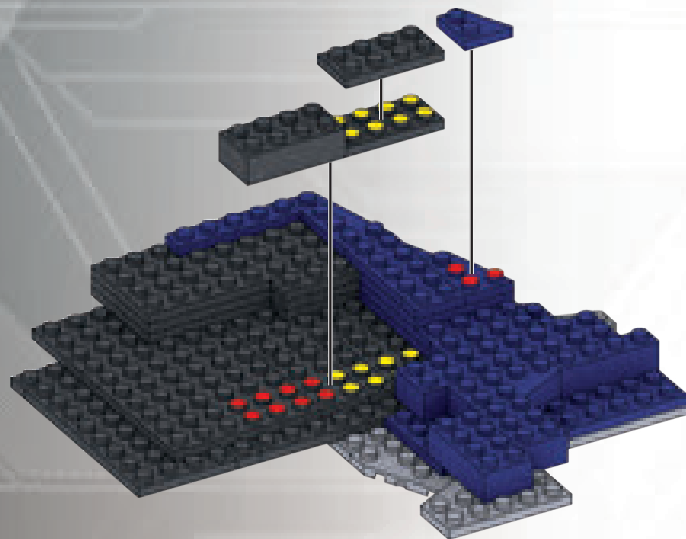

38



1X



1X



1X



1X

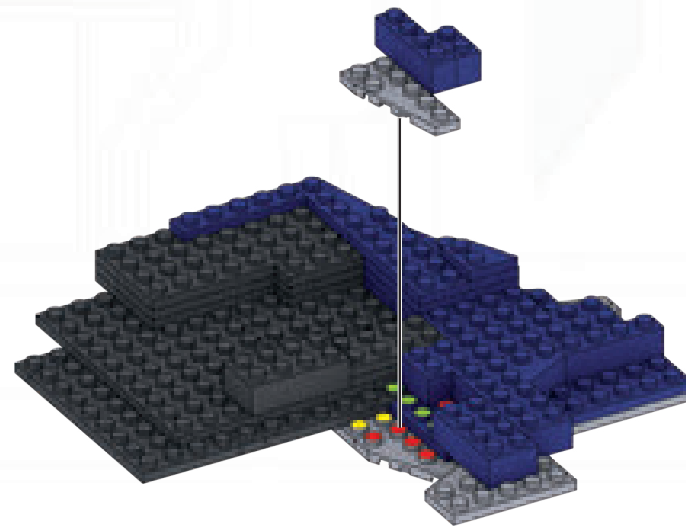

39



1X



1X



1X

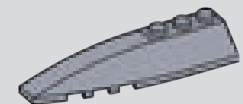

1X

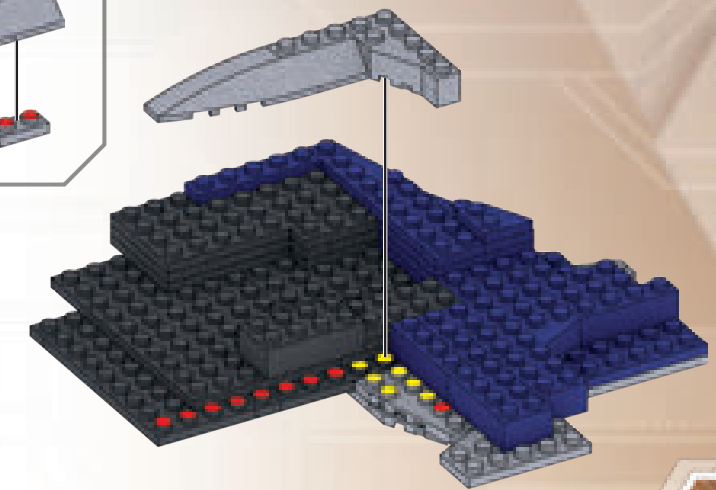
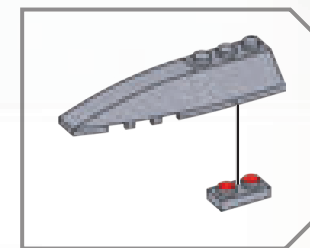

40

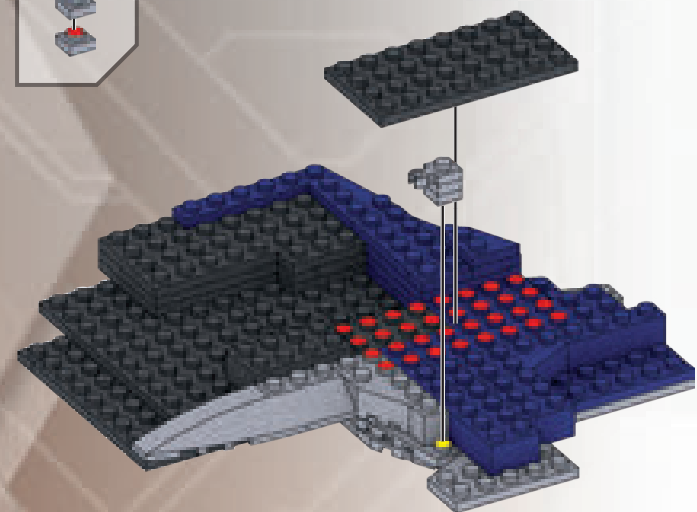
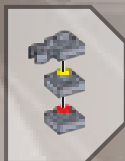

41

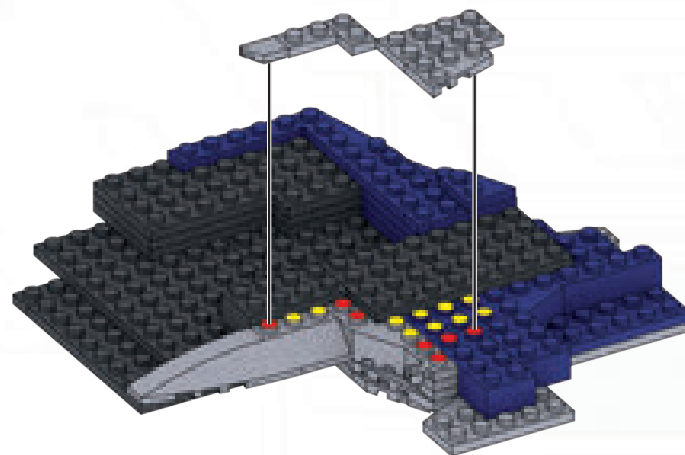

42

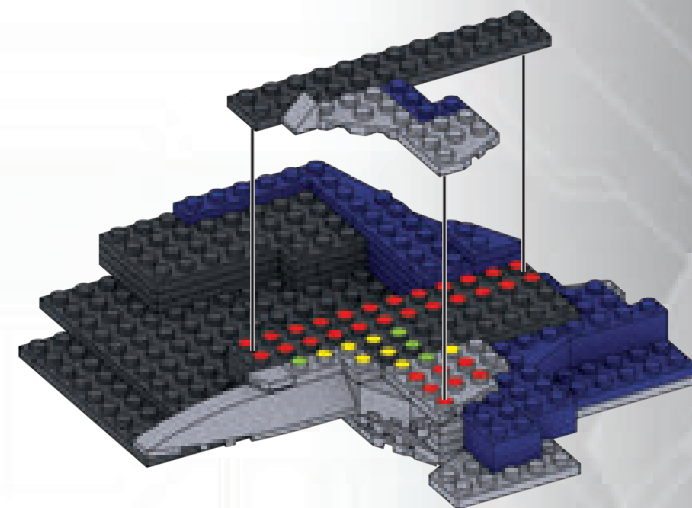
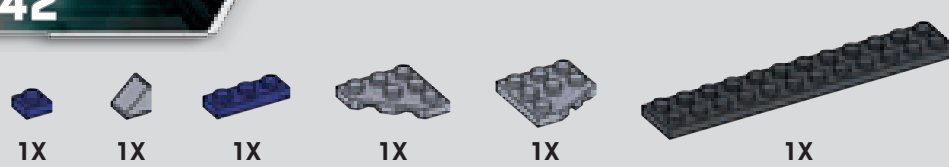

43

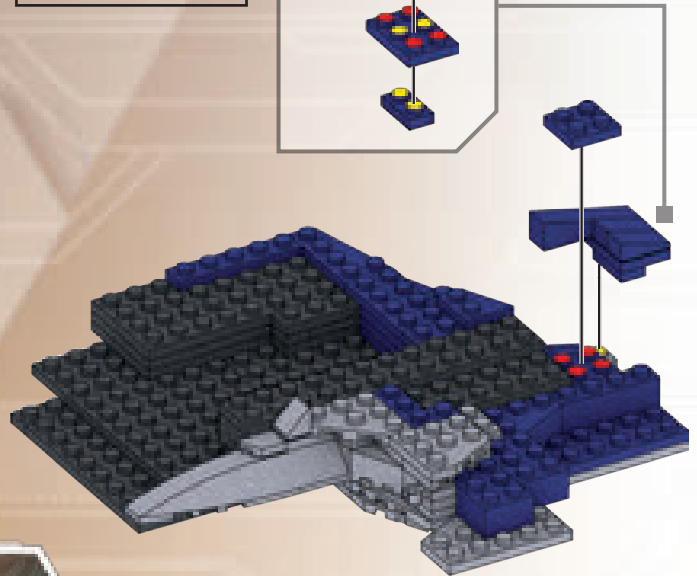
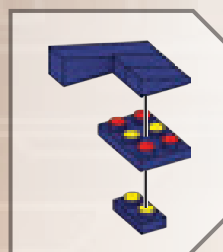

44

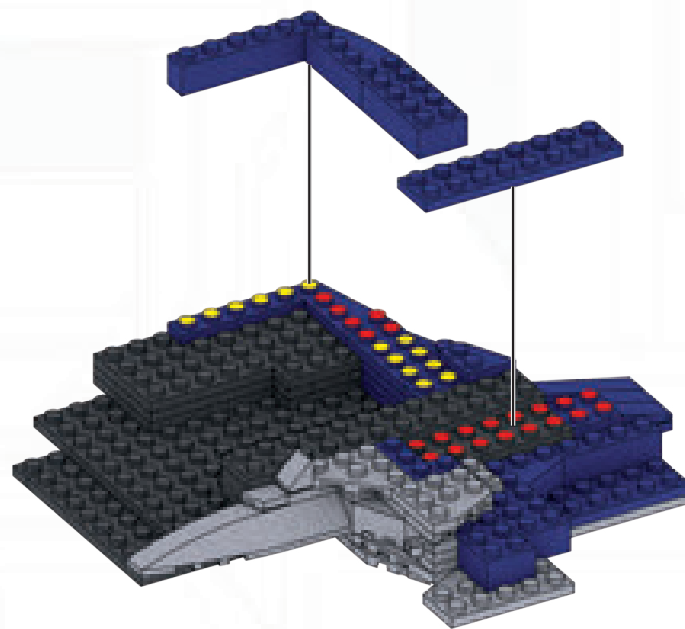
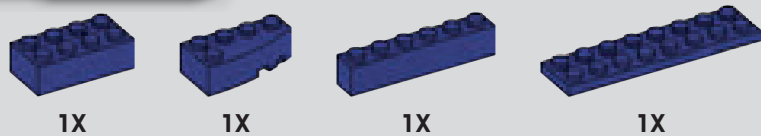

45

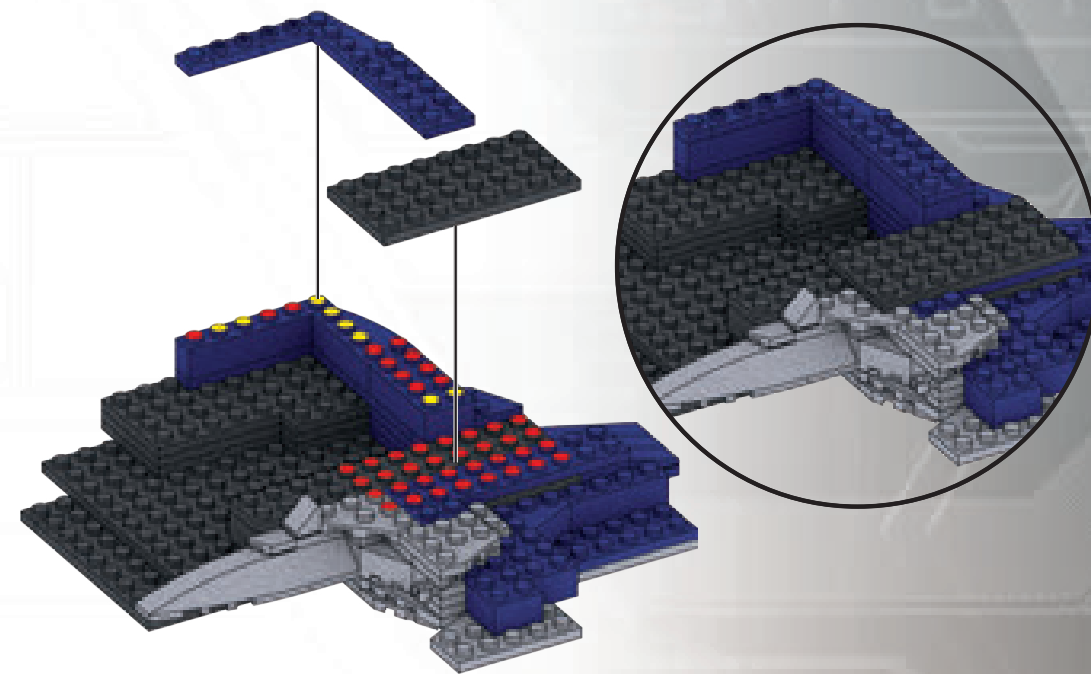



46

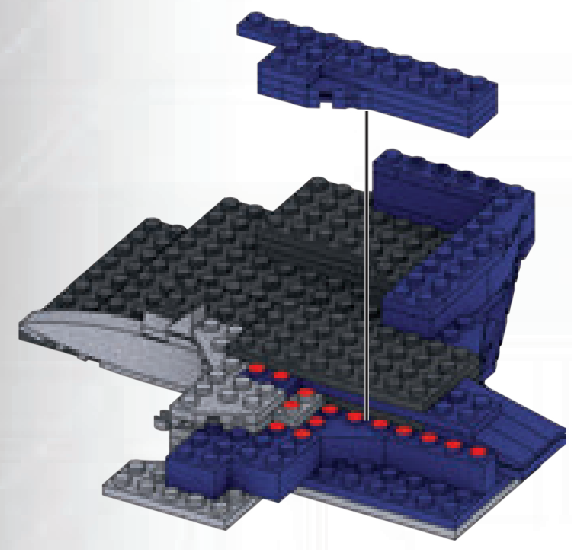
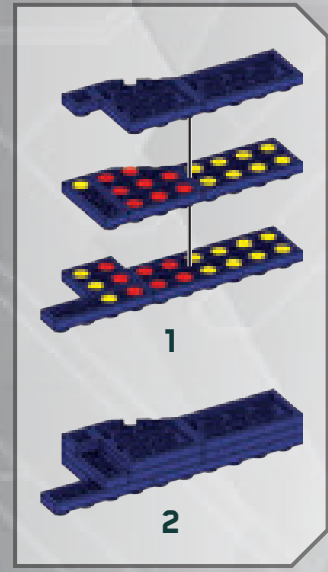
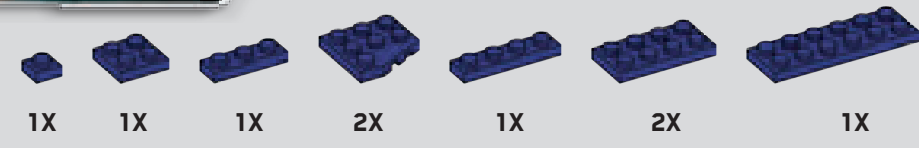

47

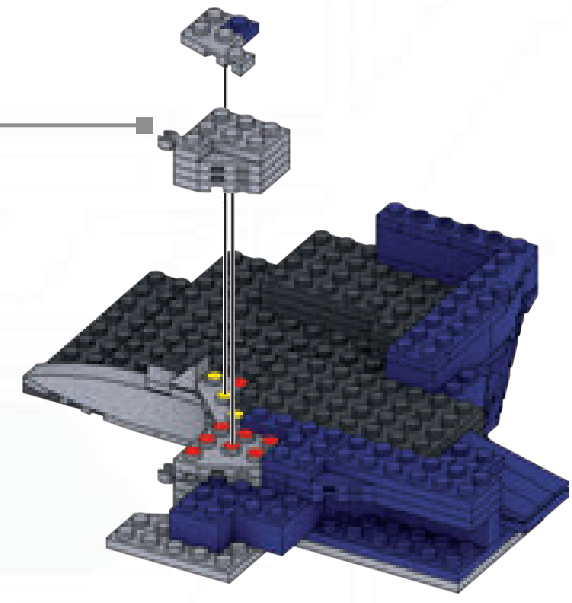
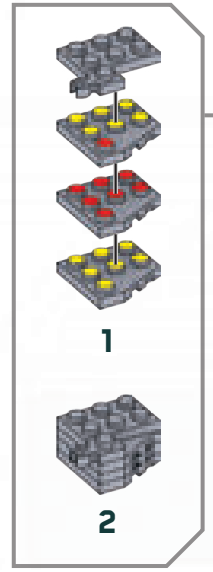
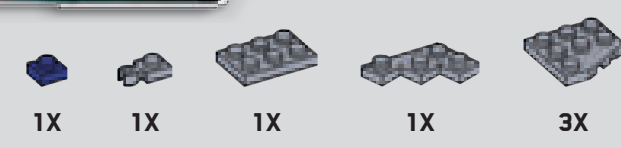

48

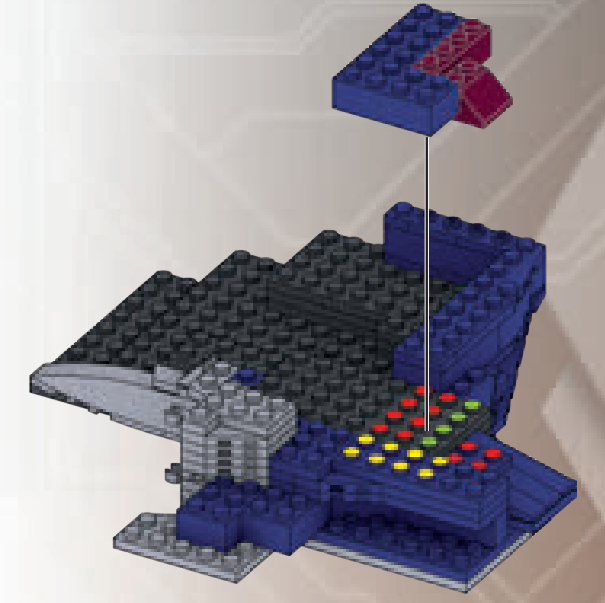
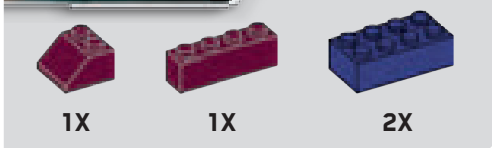

49

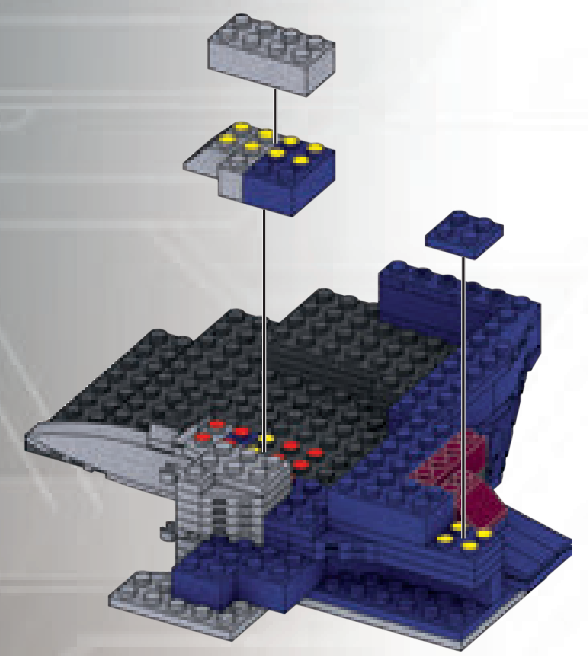
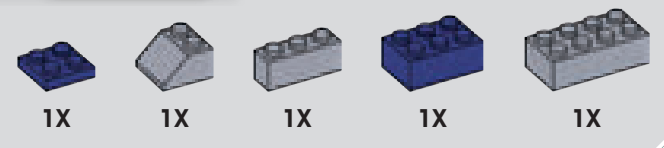

50

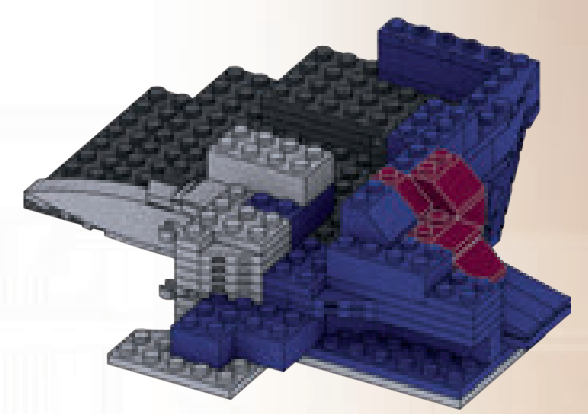
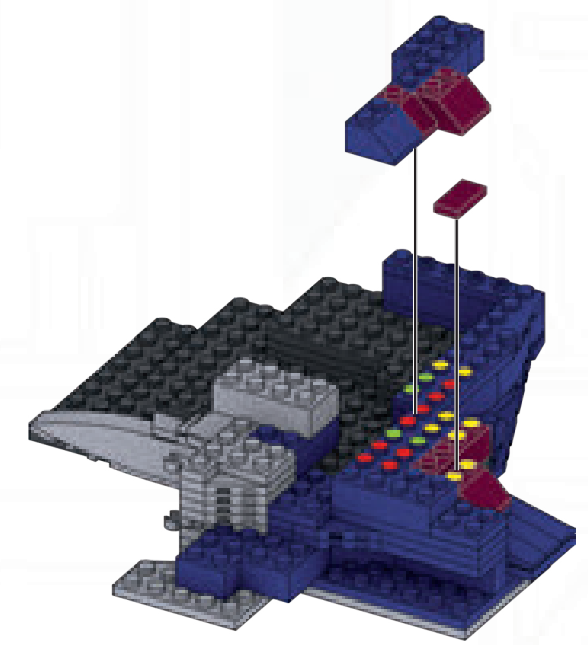
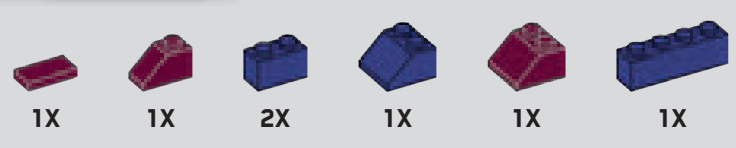

1

51

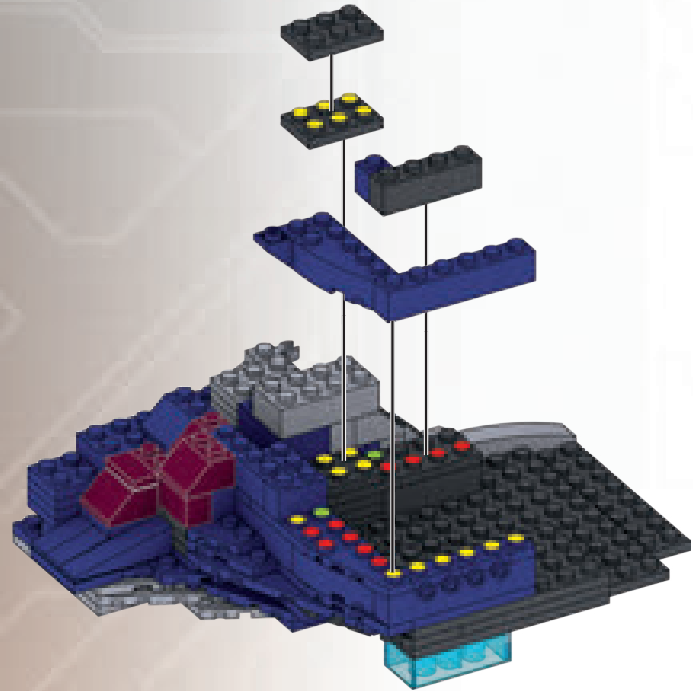

52

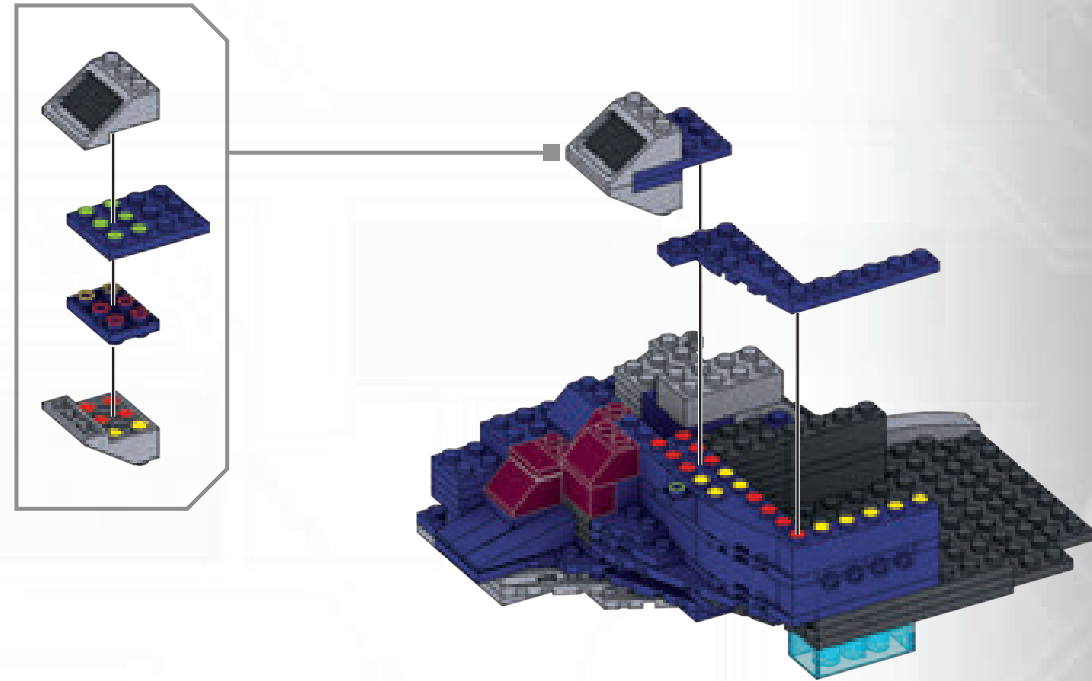
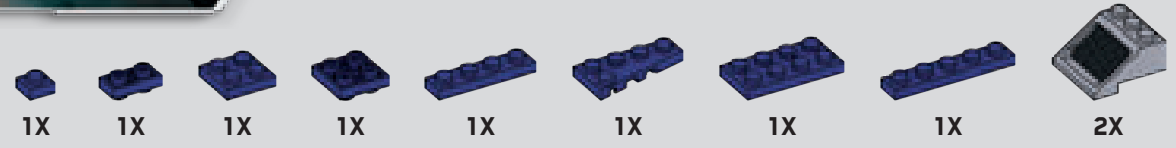

53

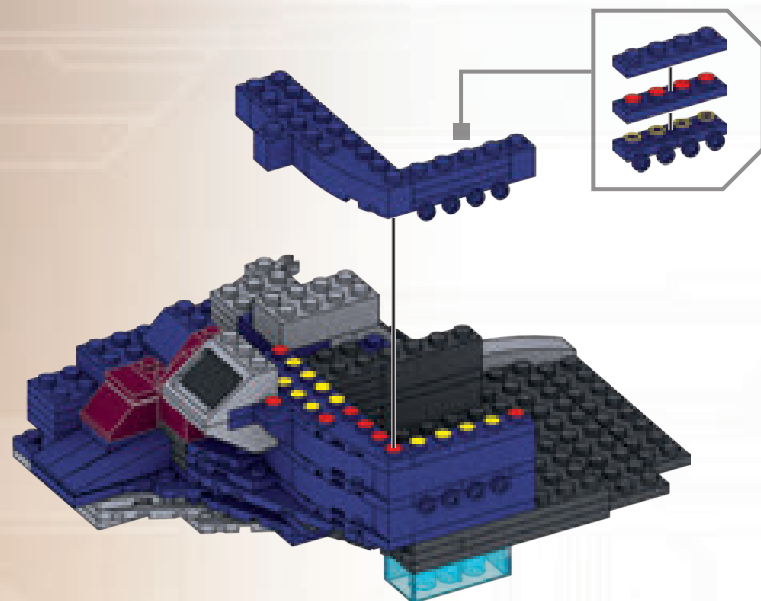

54

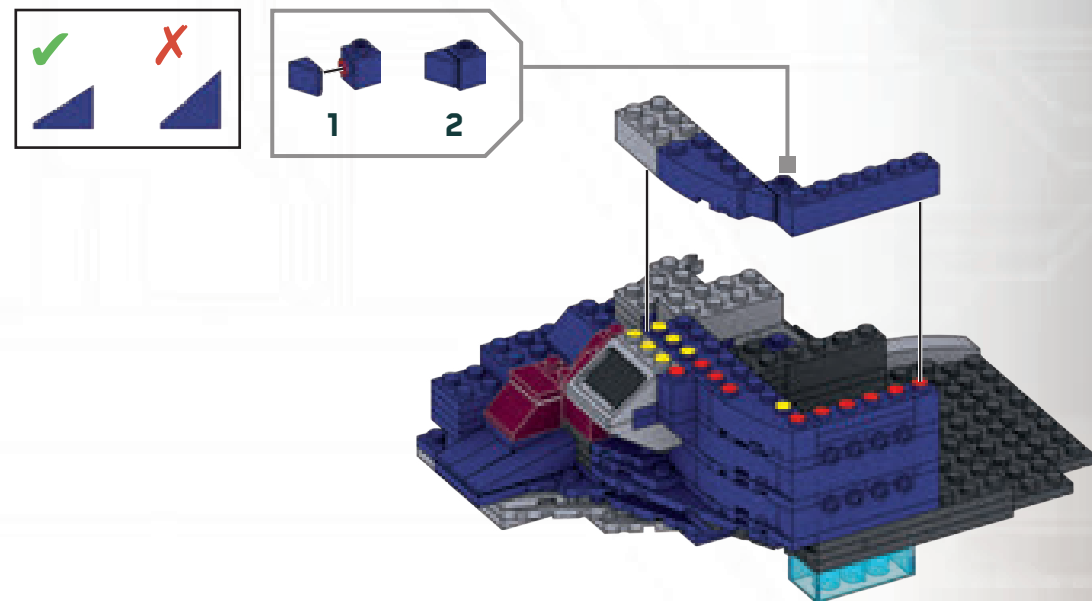
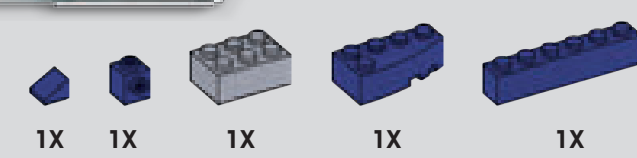

55

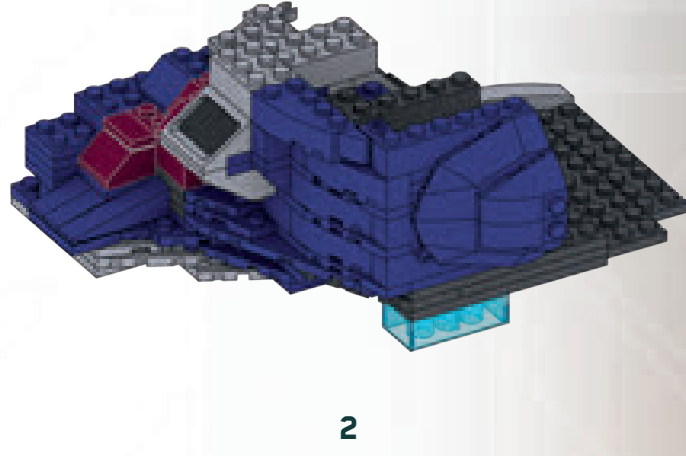
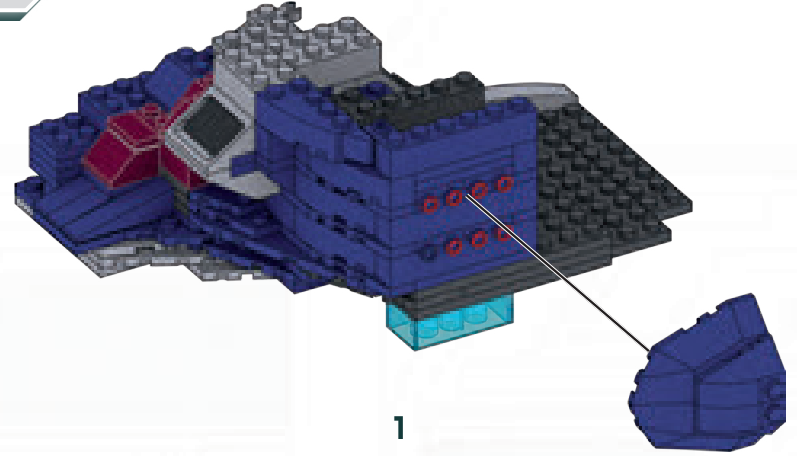
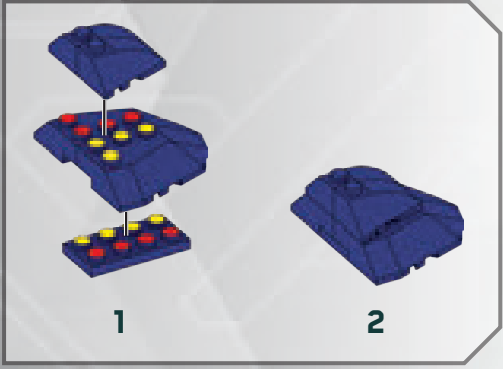
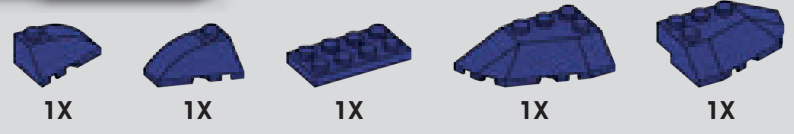

56

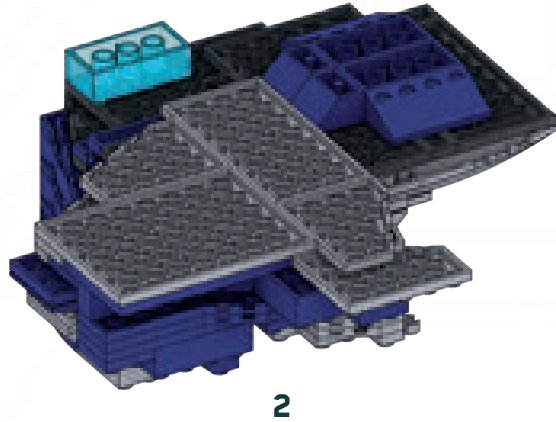
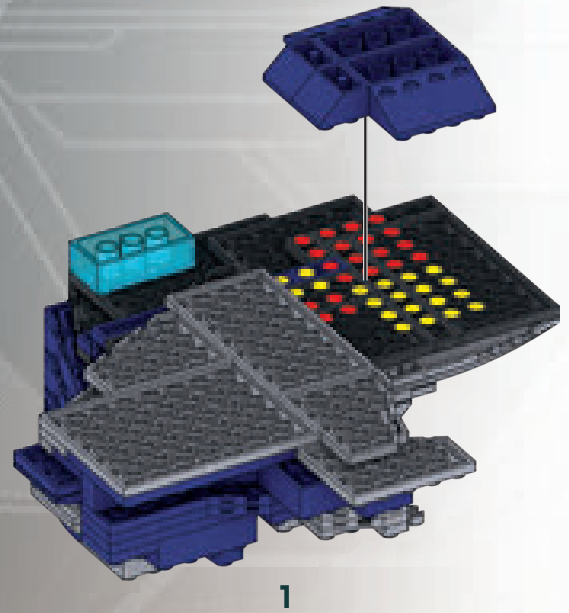
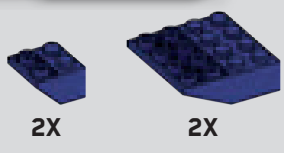

57

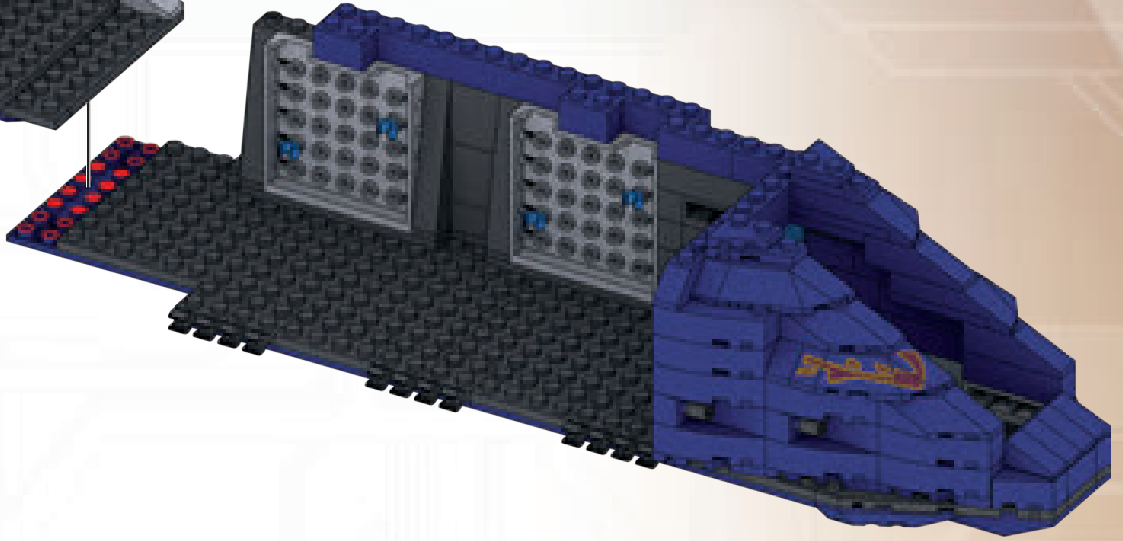
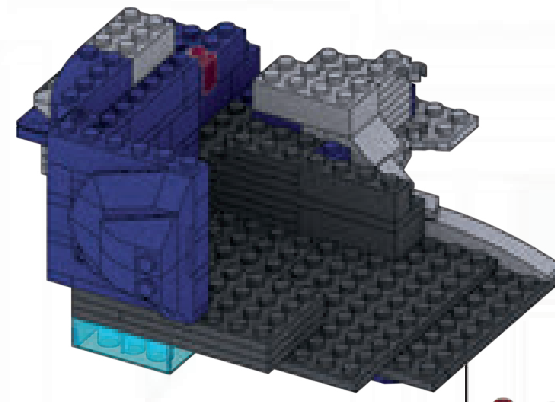

58



1X



1X



1X

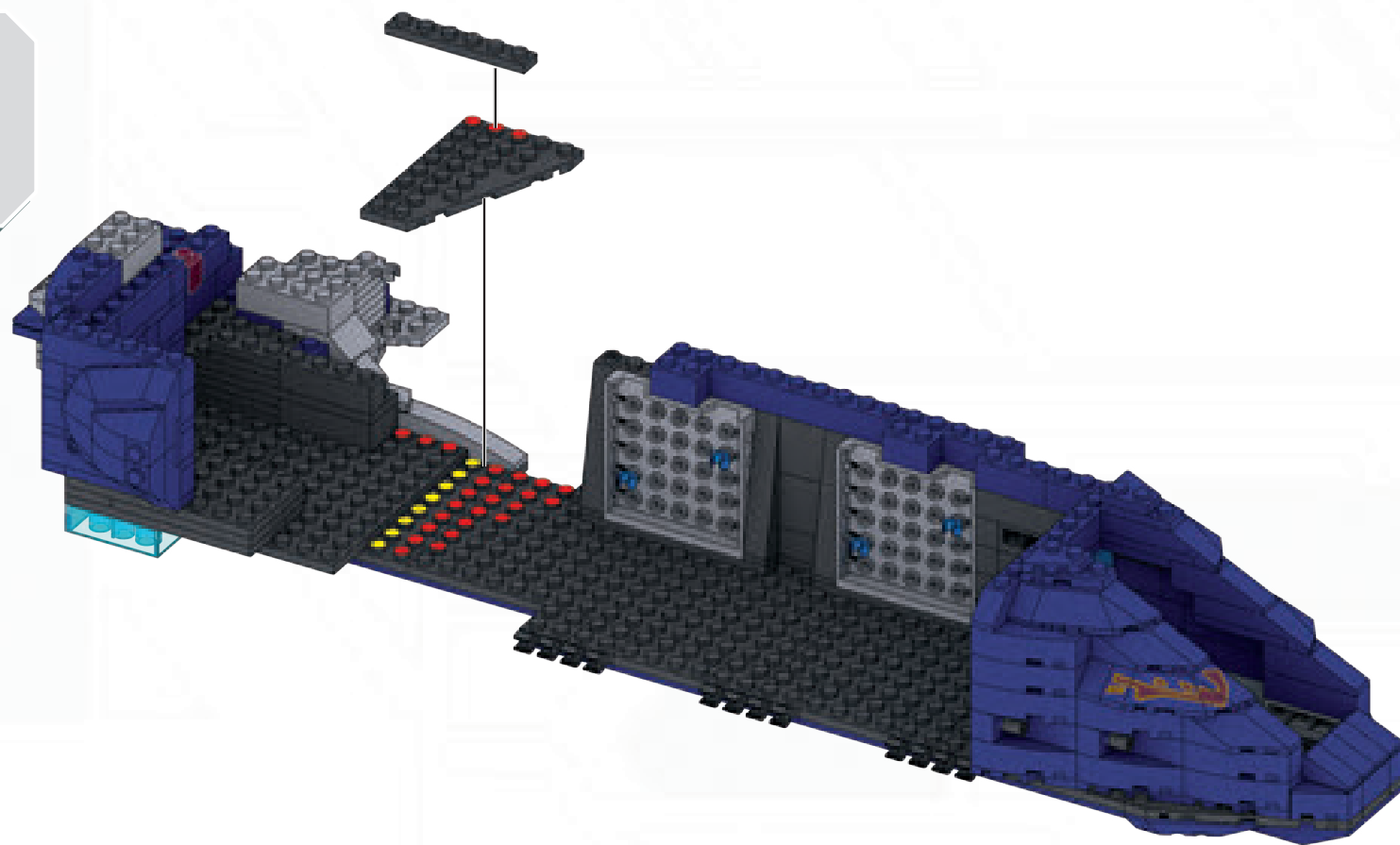

59



1X

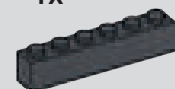

1X



1X

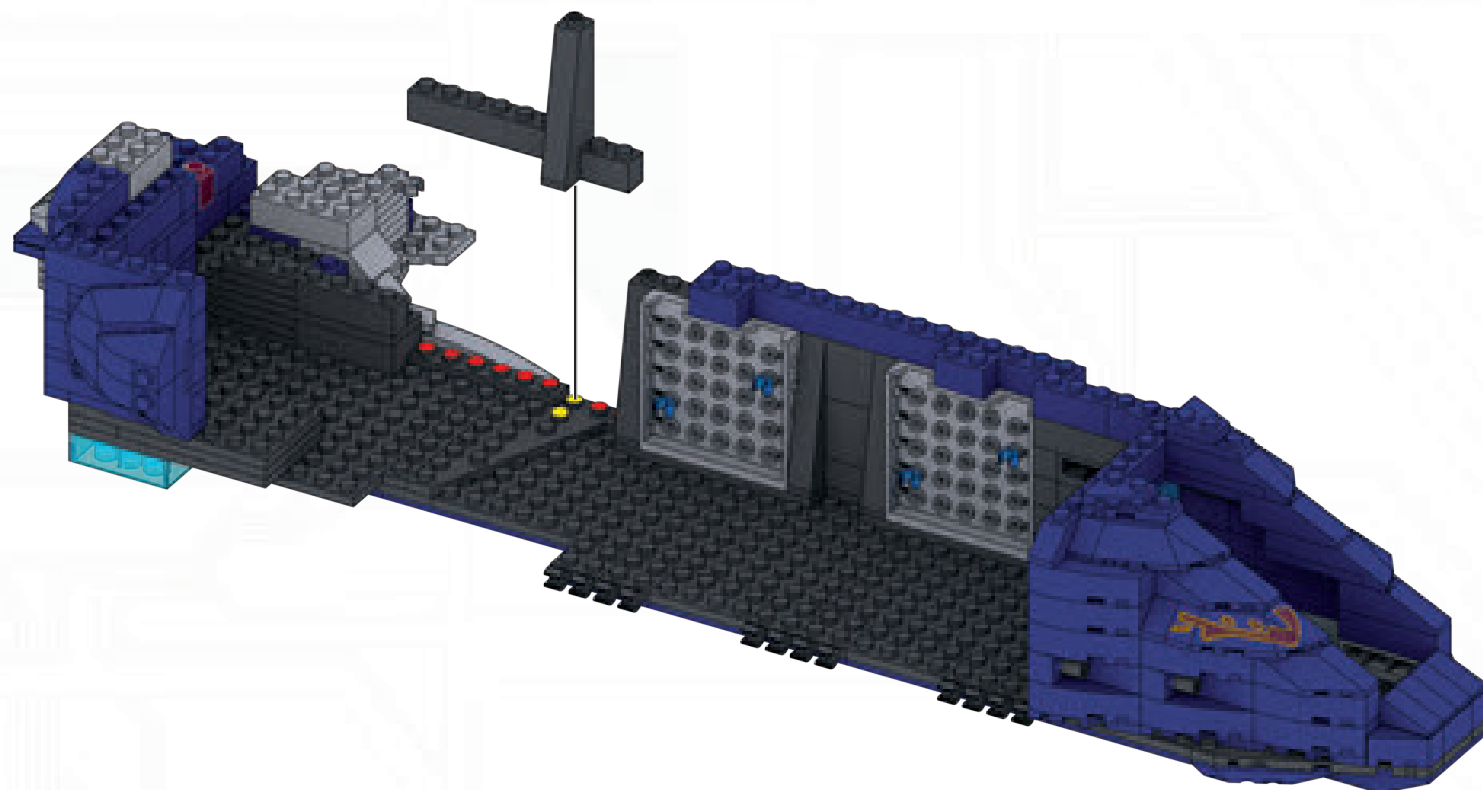

60

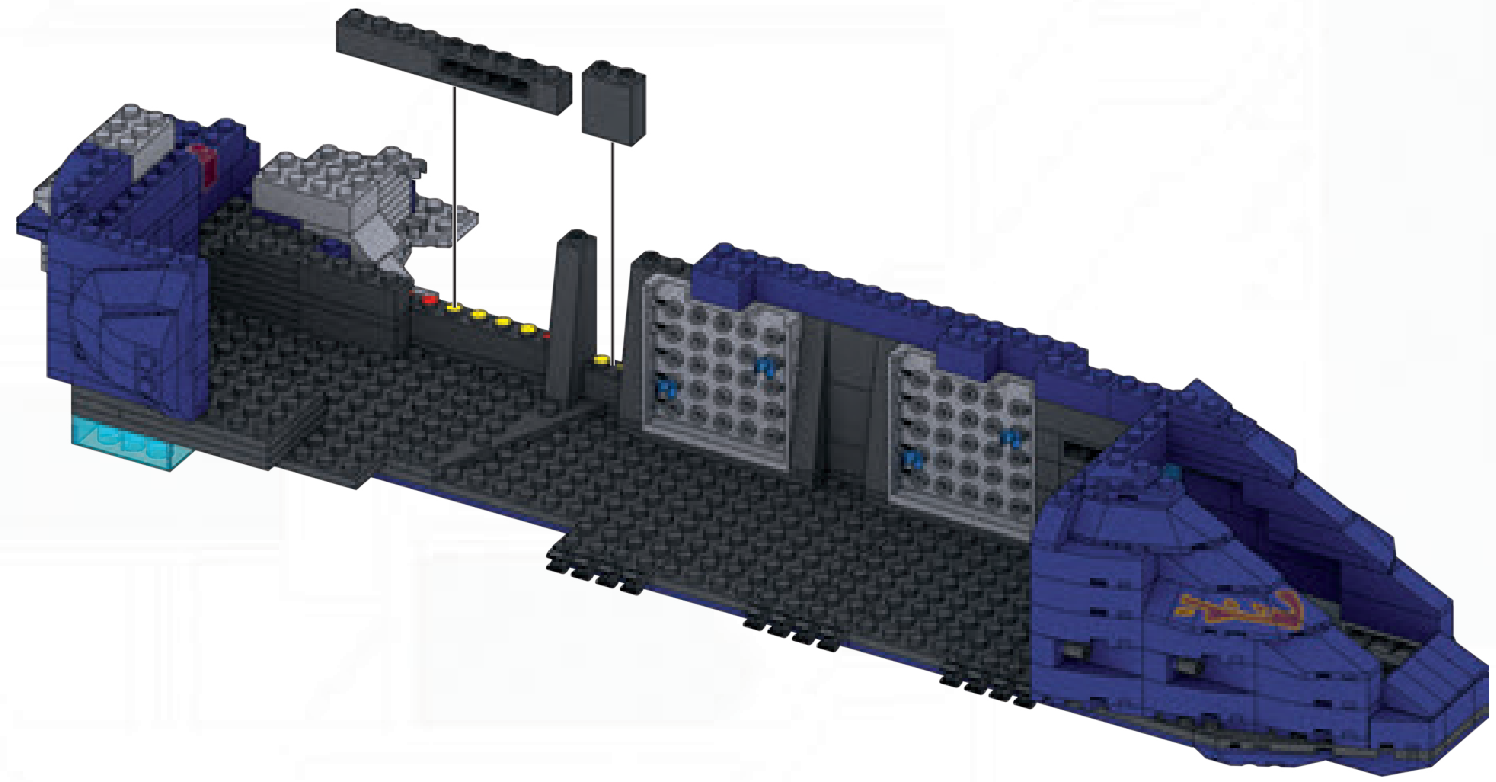

61

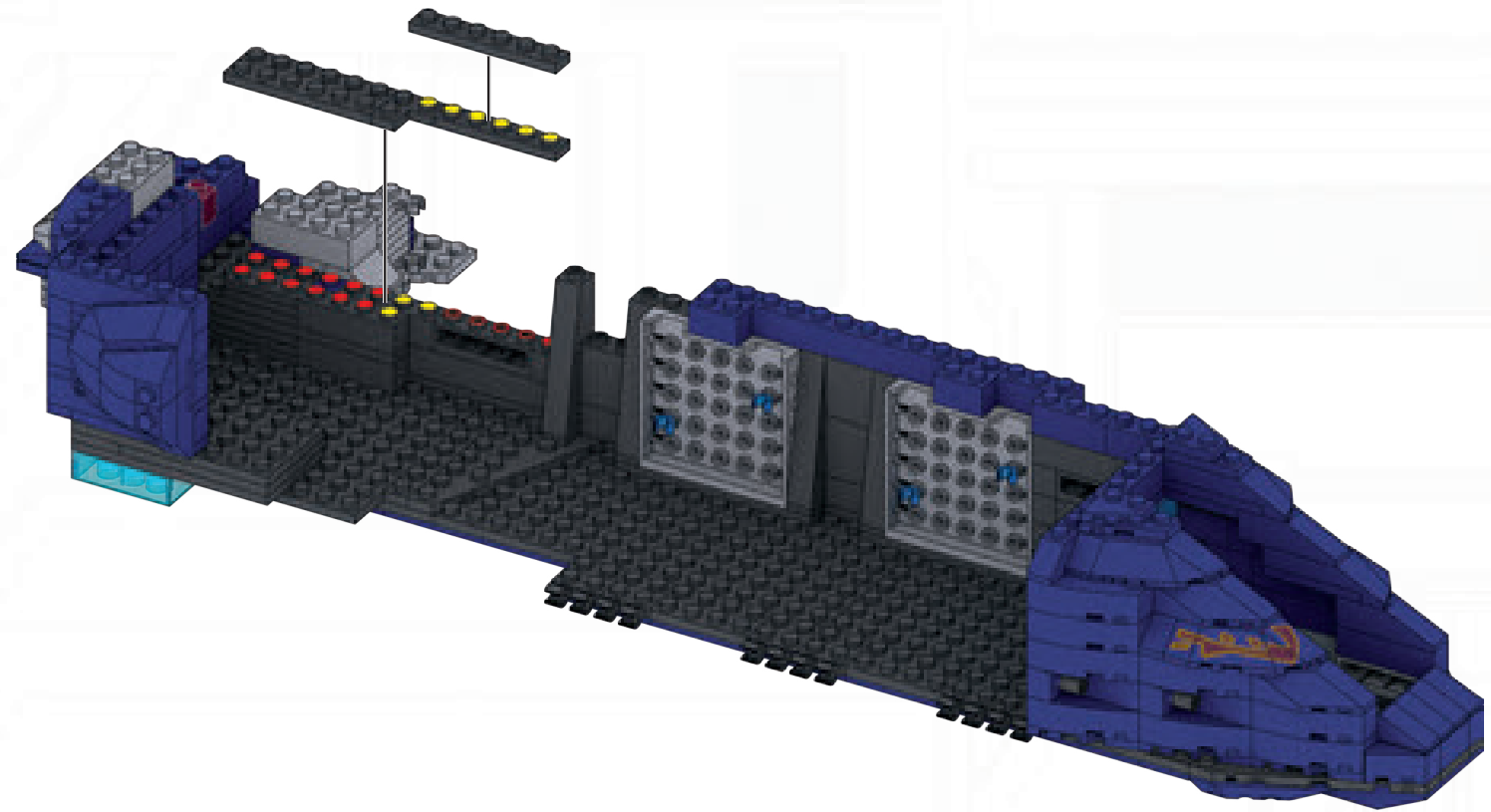

1

62

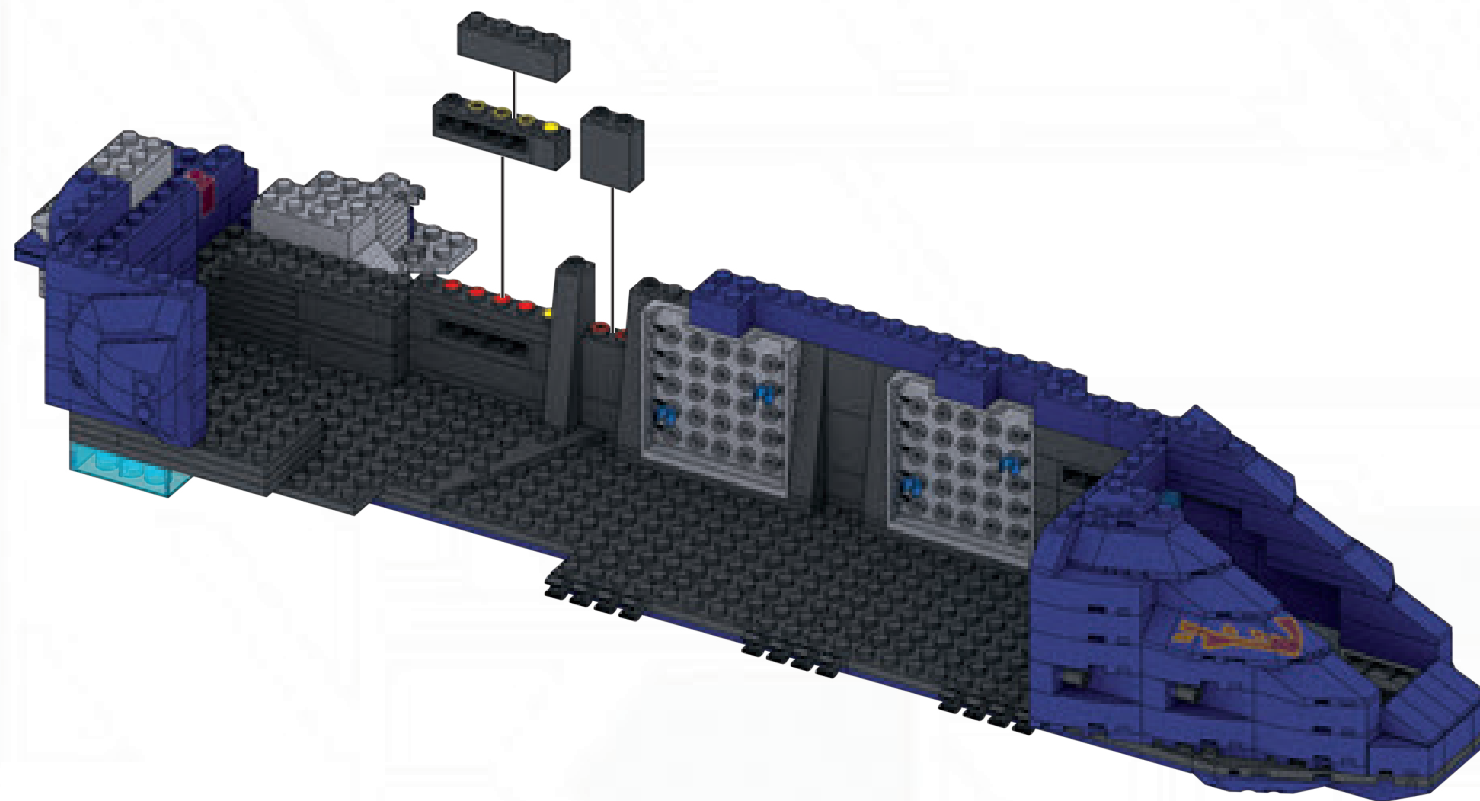

63

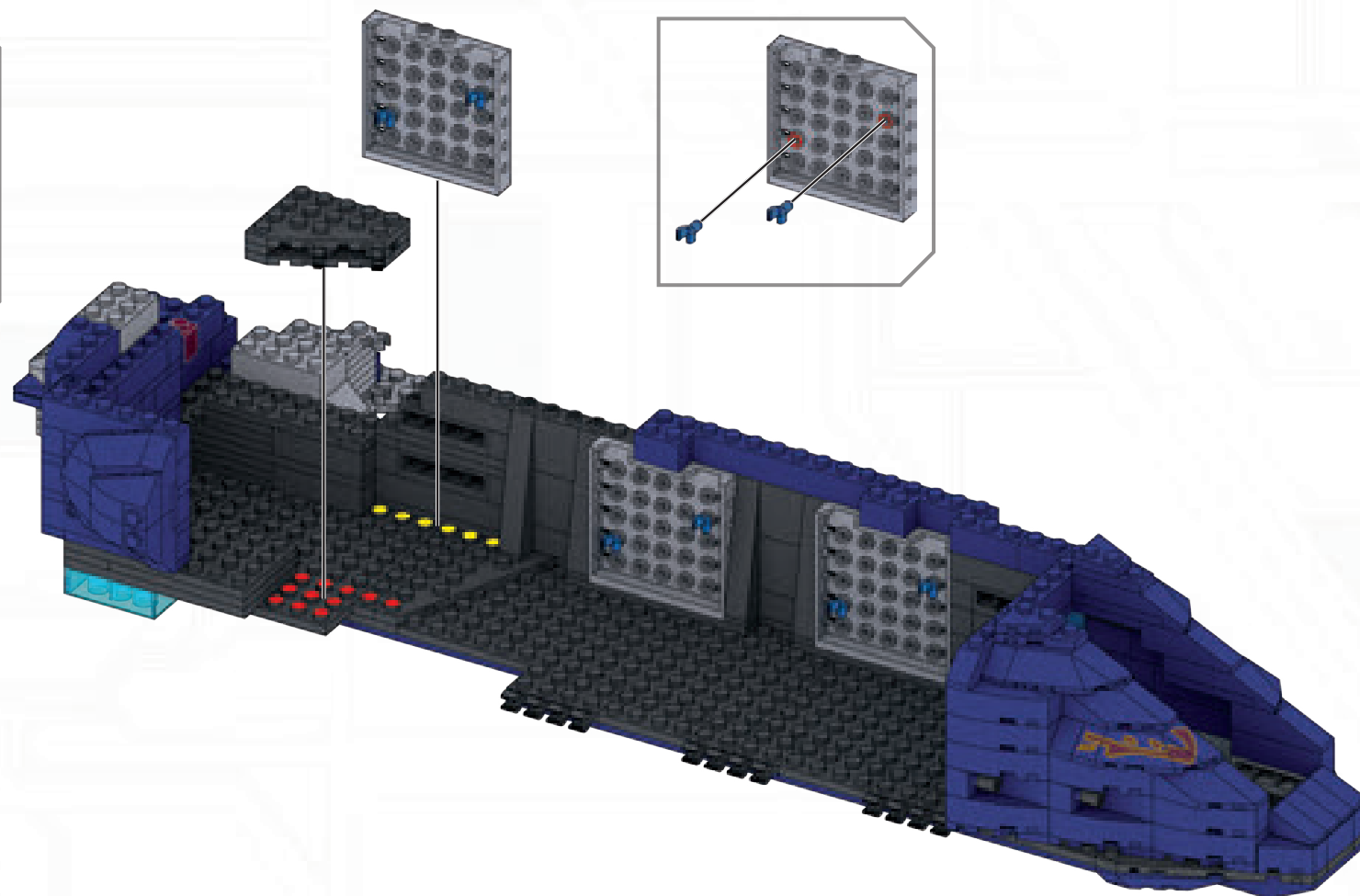
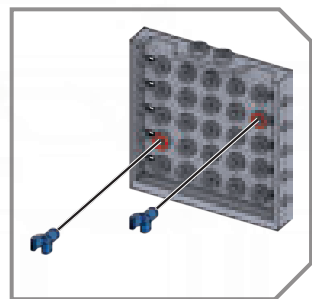
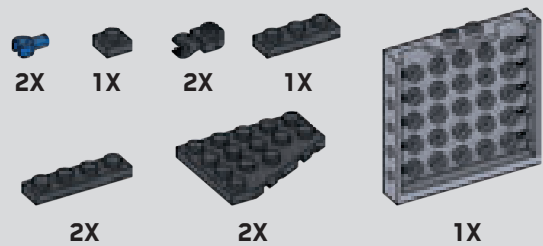

**64**

1X      1X

Remove temporary piece  
 Retirez la pièce temporaire  
 Retirar pieza temporal  
 Remova peça temporária  
 Rimuovere il pezzo temporaneo  
 Vorübergehendes Teil entfernen  
 Usunąć element tymczasowy.  
 Verwijder tijdelijke bouwsteen  
 Снимите временную деталь  
 Fjern midlertidigt stykke.  
 Ta bort temporär del  
 Fjern midlertidig del  
 Poista väliaikainen osa  
 Αφαίρεση προσωρινού κομματιού  
 انزع القطعة المؤقتة  
 移除临时件  
 暫定ピースを外してください

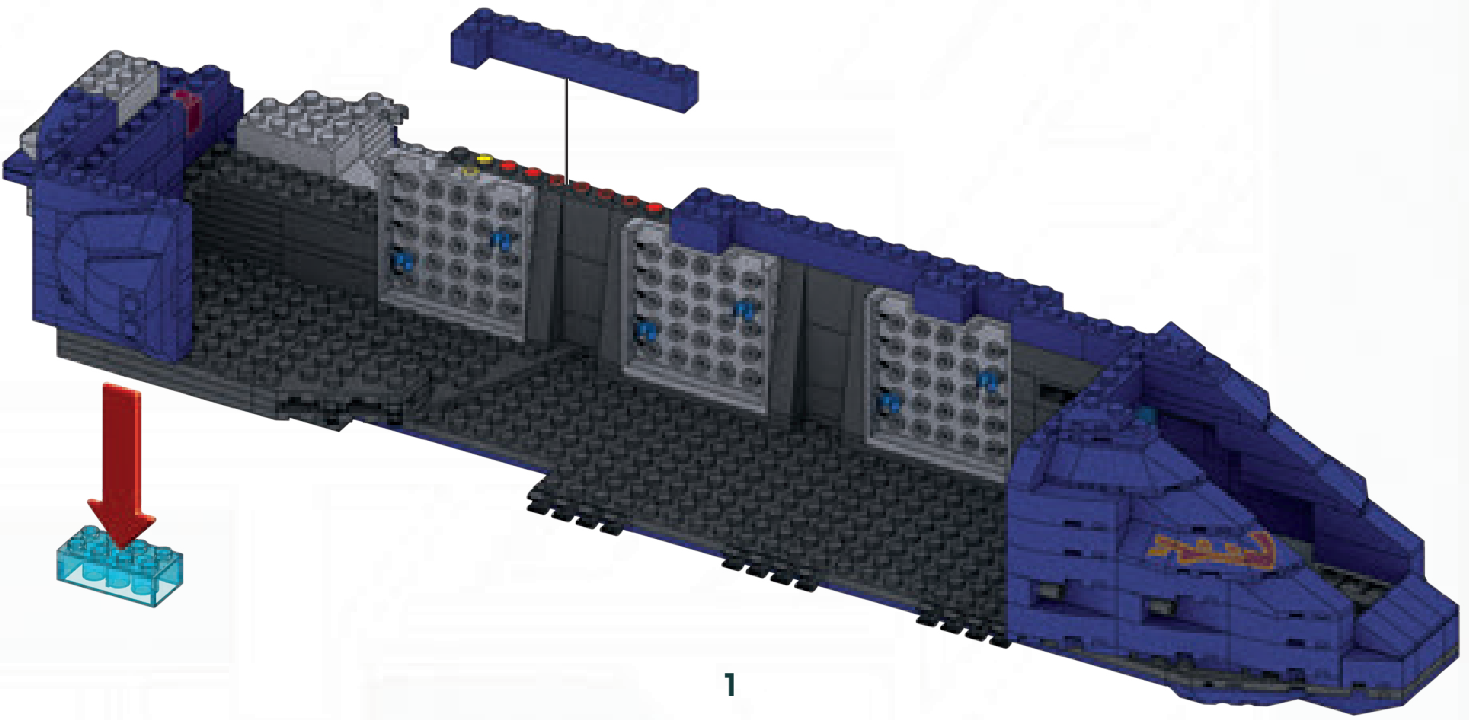

1

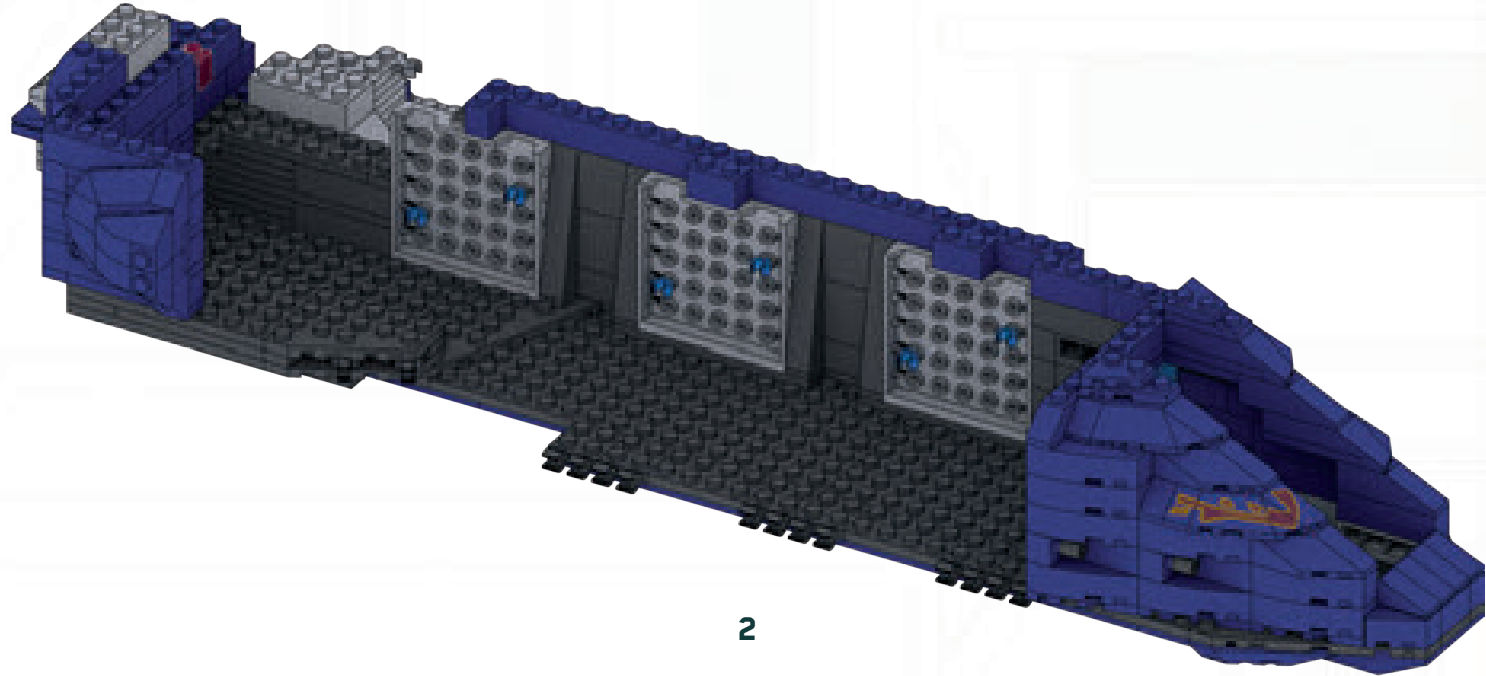

2

1



**SECTION • SECCIÓN • ABSCHNITT**  
**SECTIE • SEZIONE • SECÇÃO**





2

24-43



2

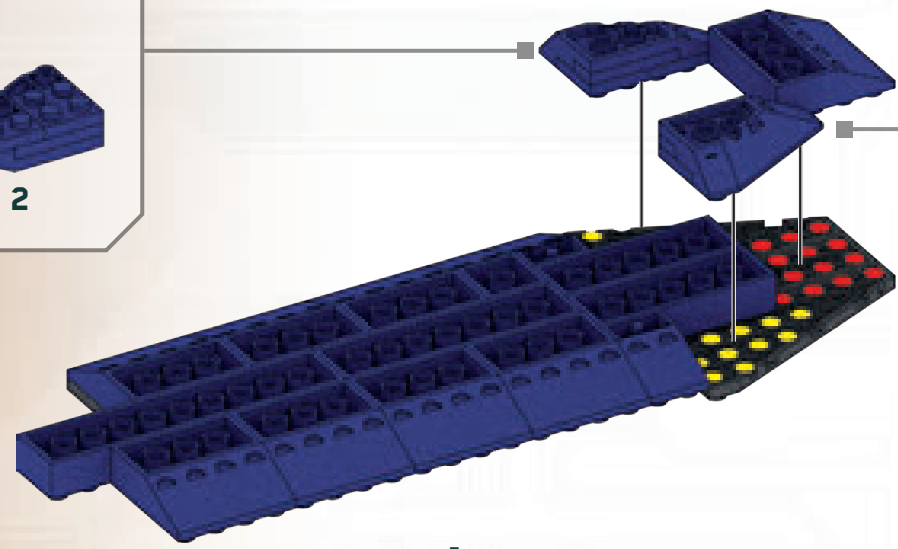
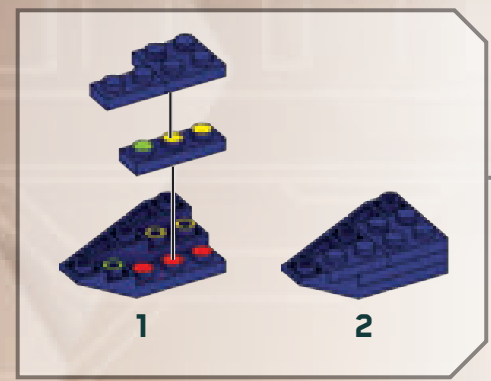
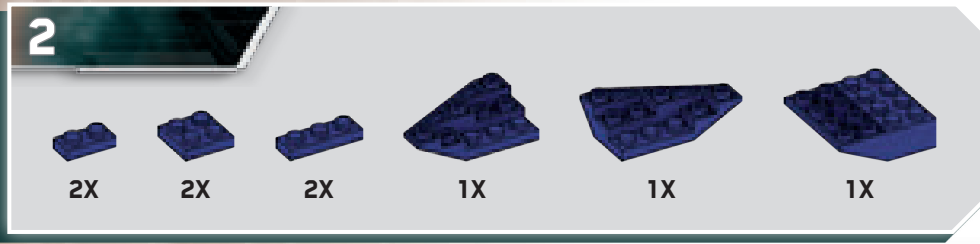
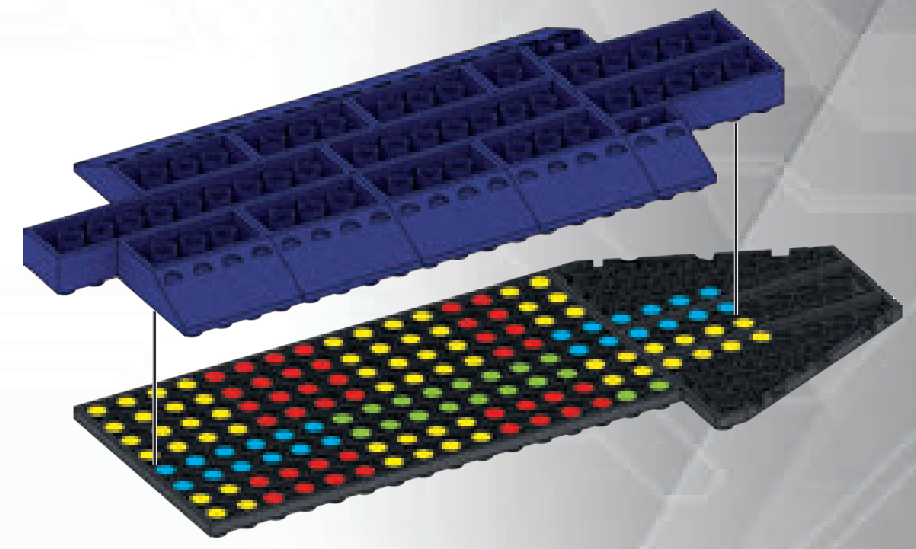
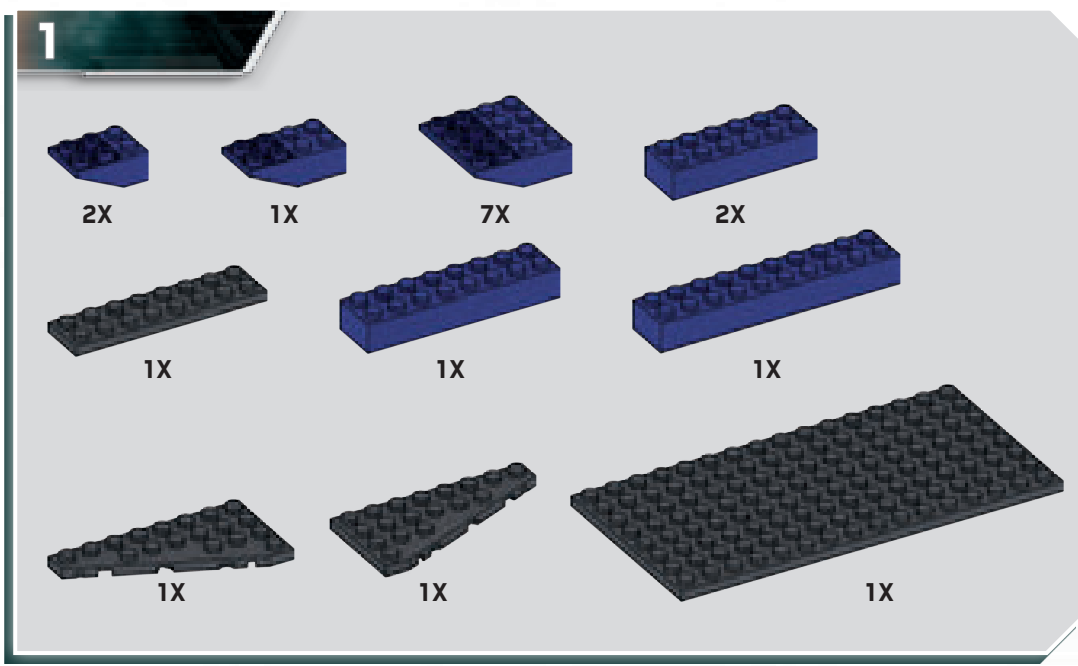
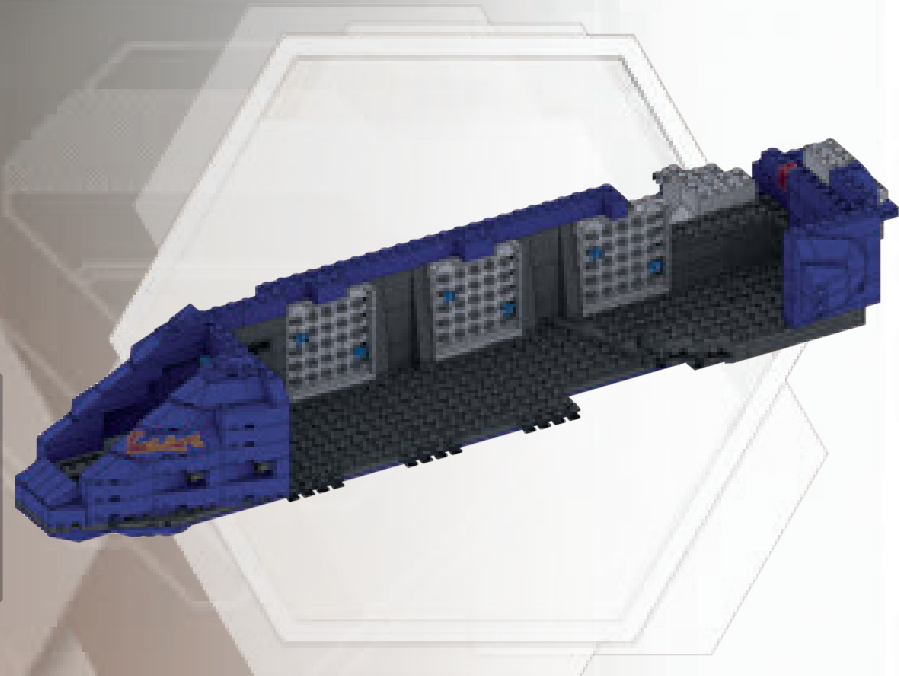

1

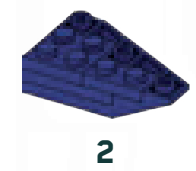
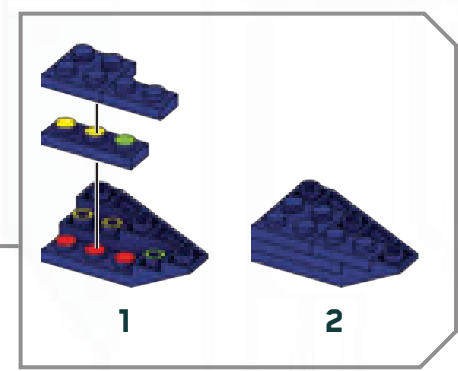

2

**3**

3X 1X 1X

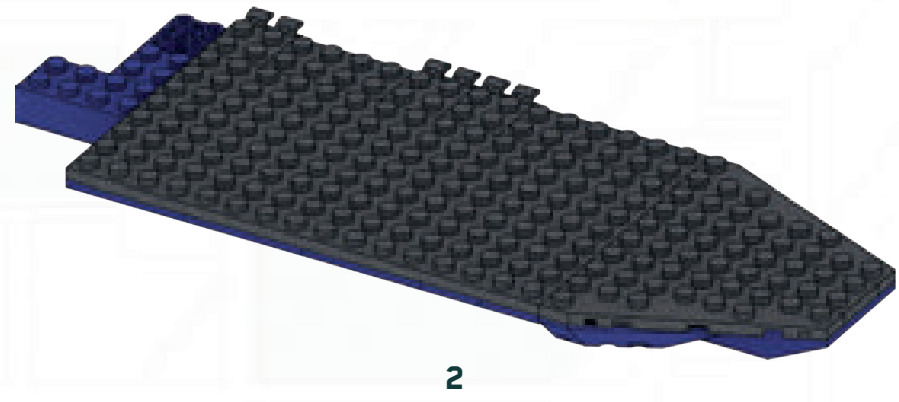
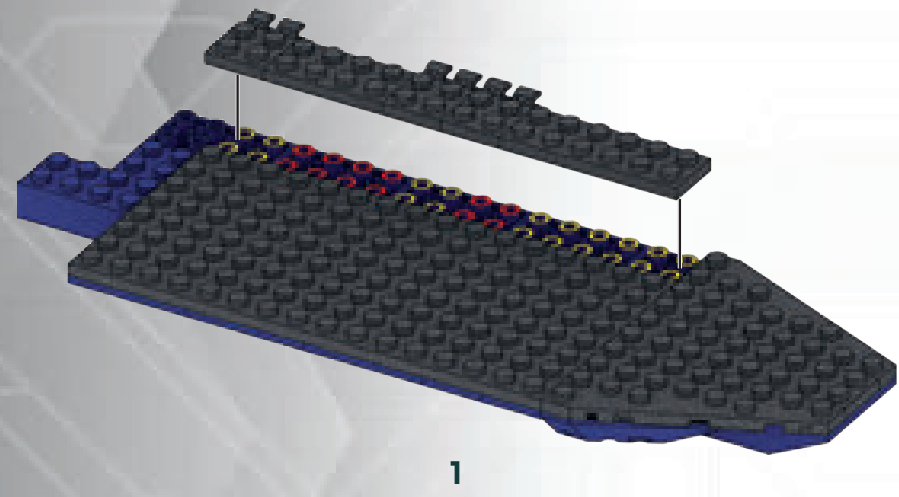

**4**

2X 7X 1X

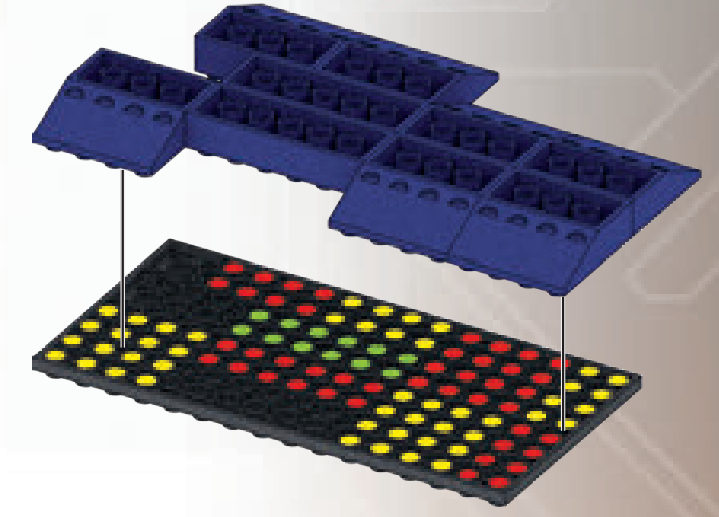

**5**

1X 1X 3X 1X 2X 2X

1 2 1 2 1 2 3

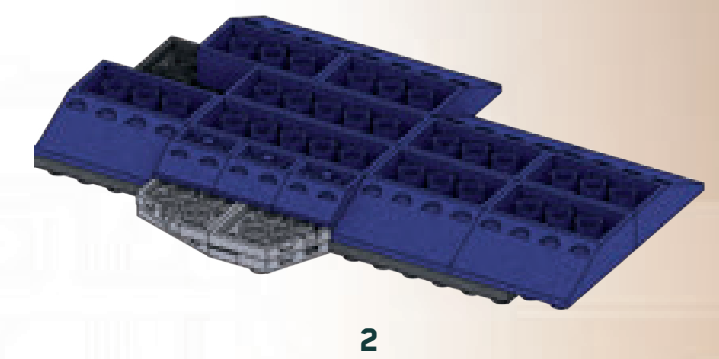
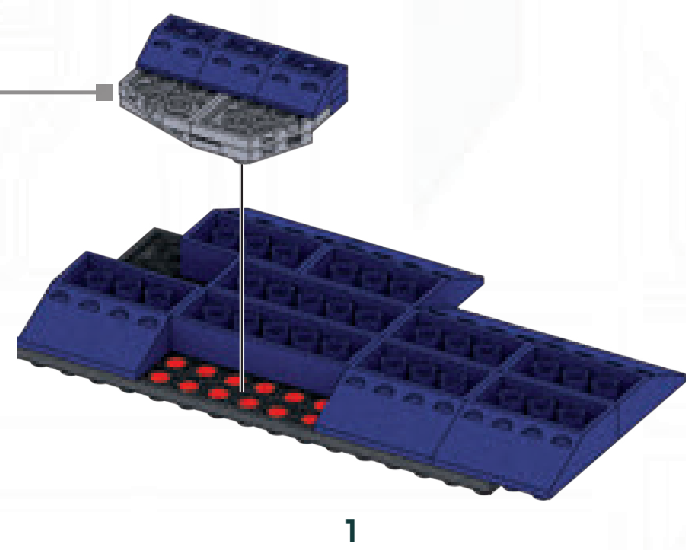

6

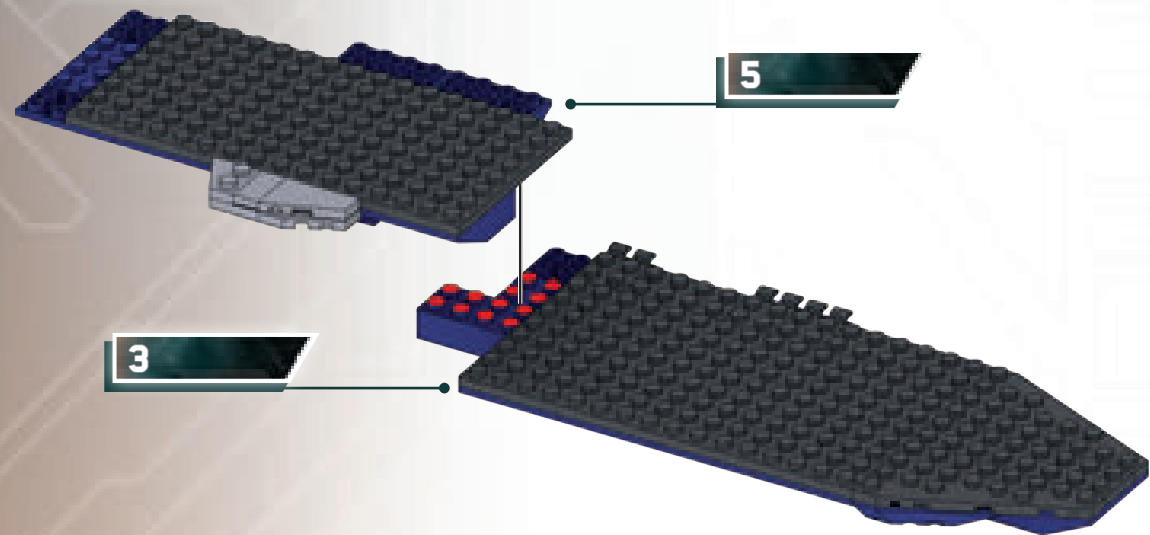

7



3X

1X

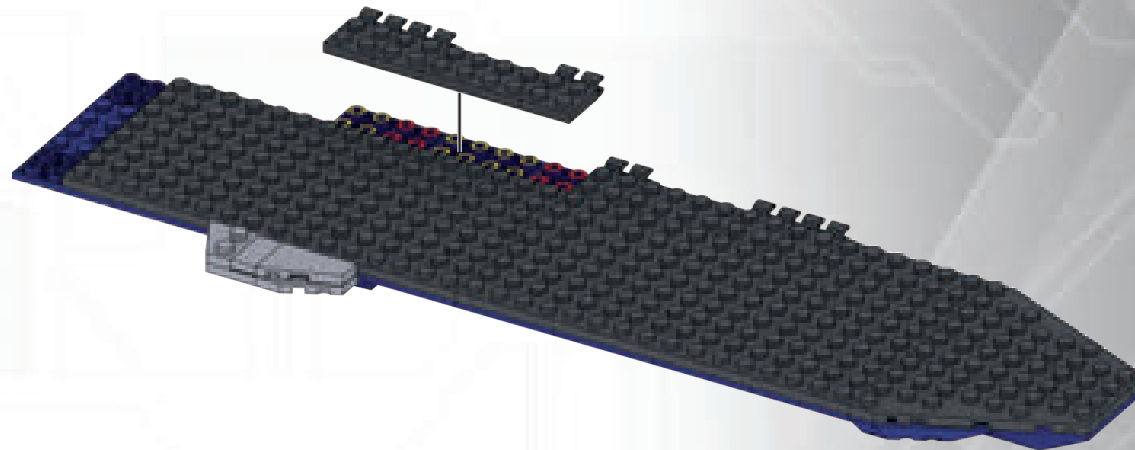

8

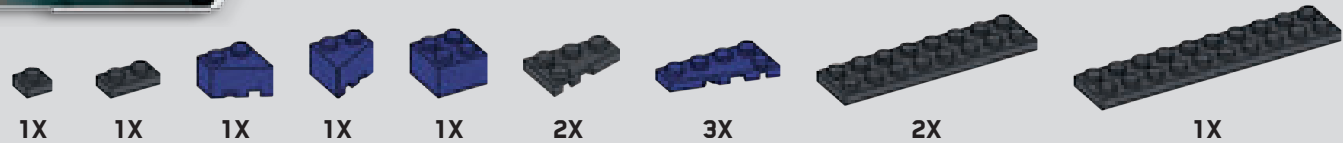

1X

1X

1X

1X

1X

2X

3X

2X

1X

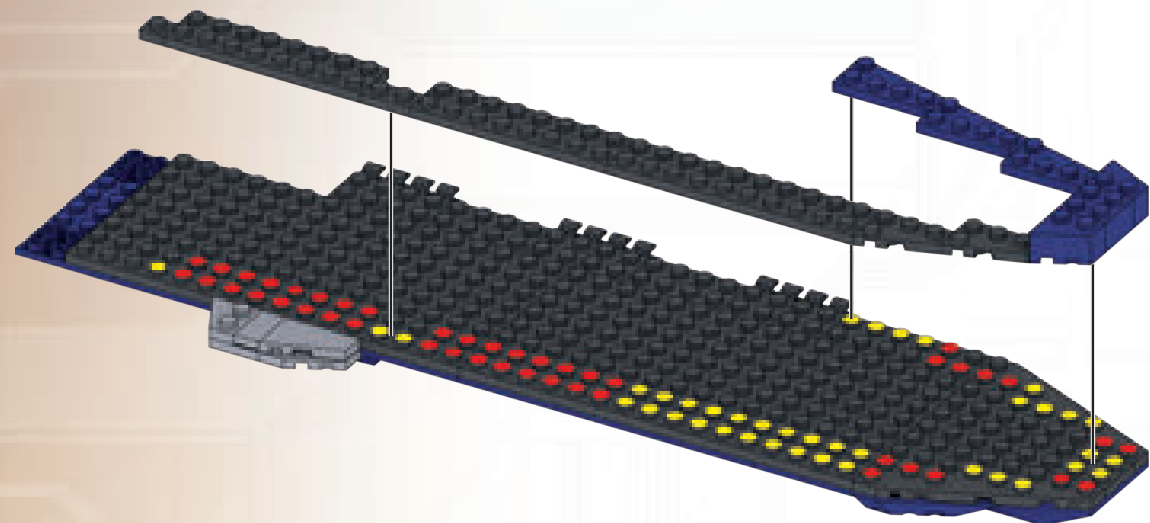

9

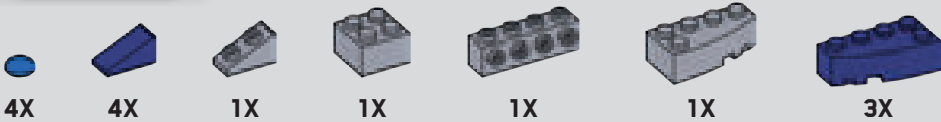

4X

4X

1X

1X

1X

1X

3X

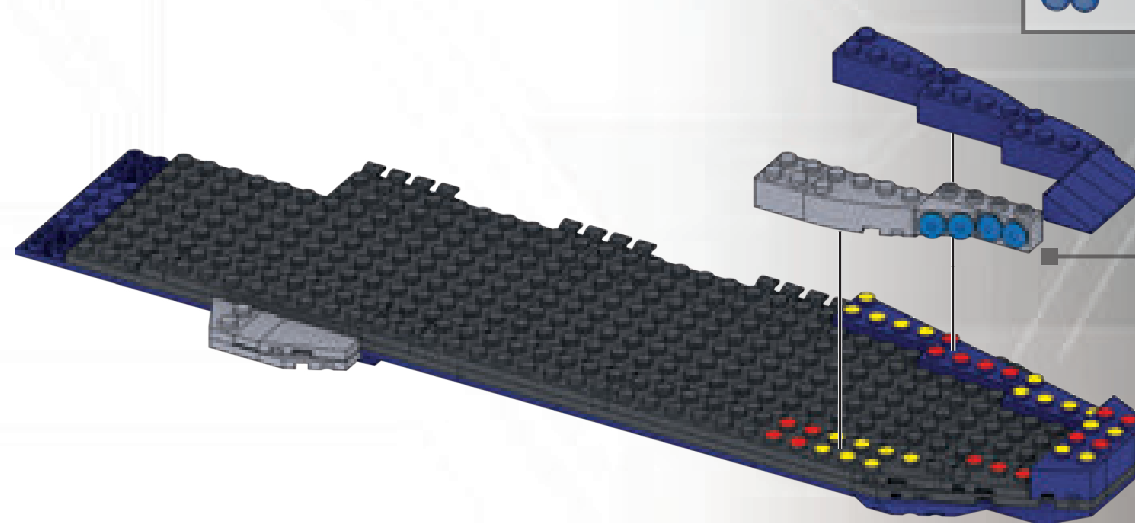
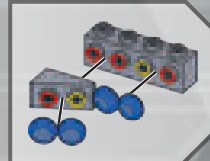

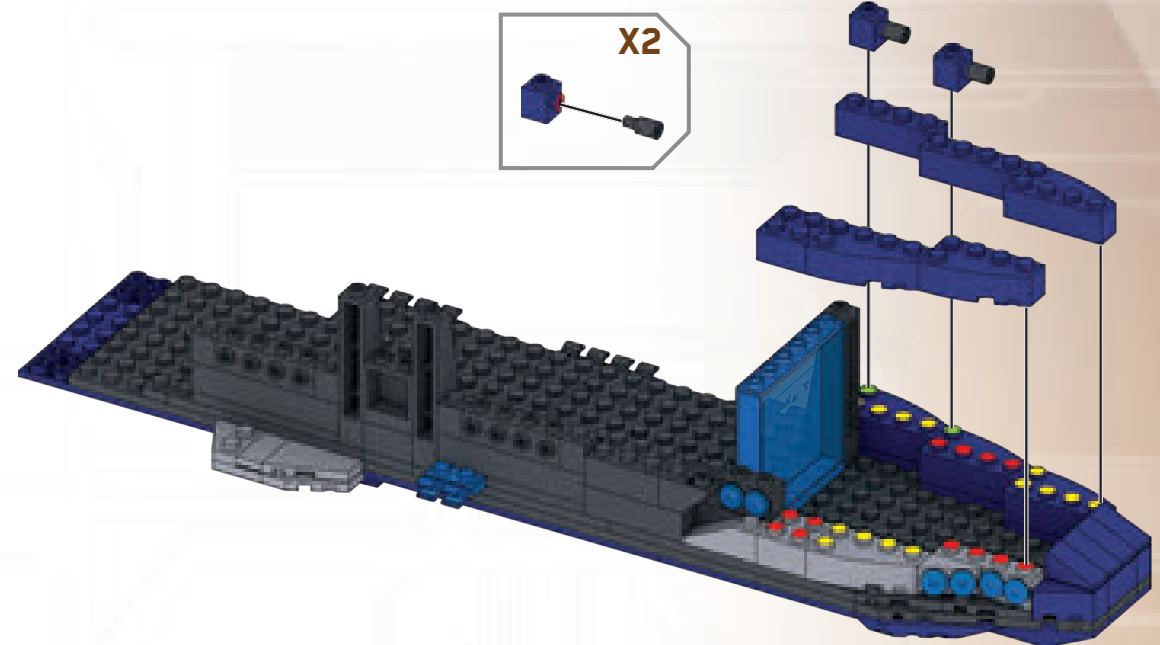
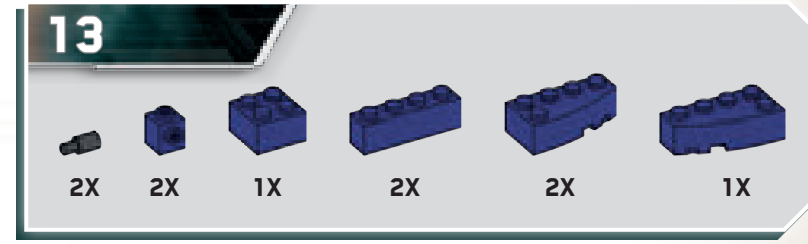
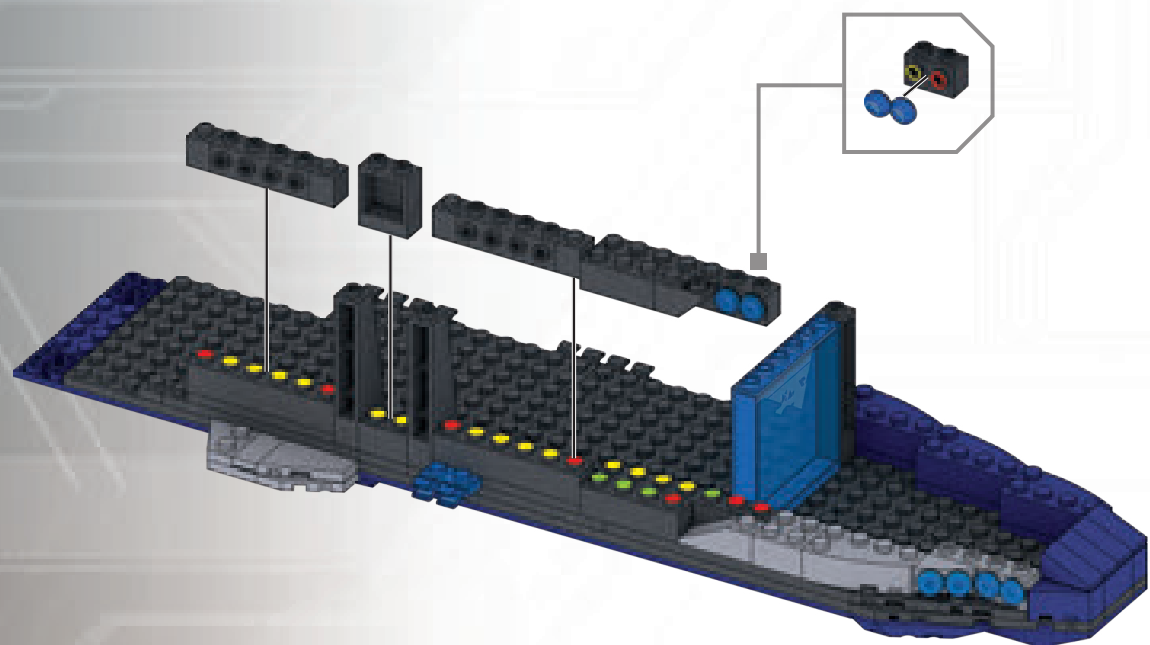
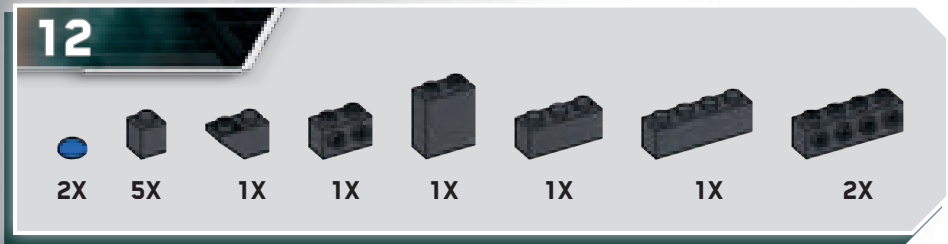
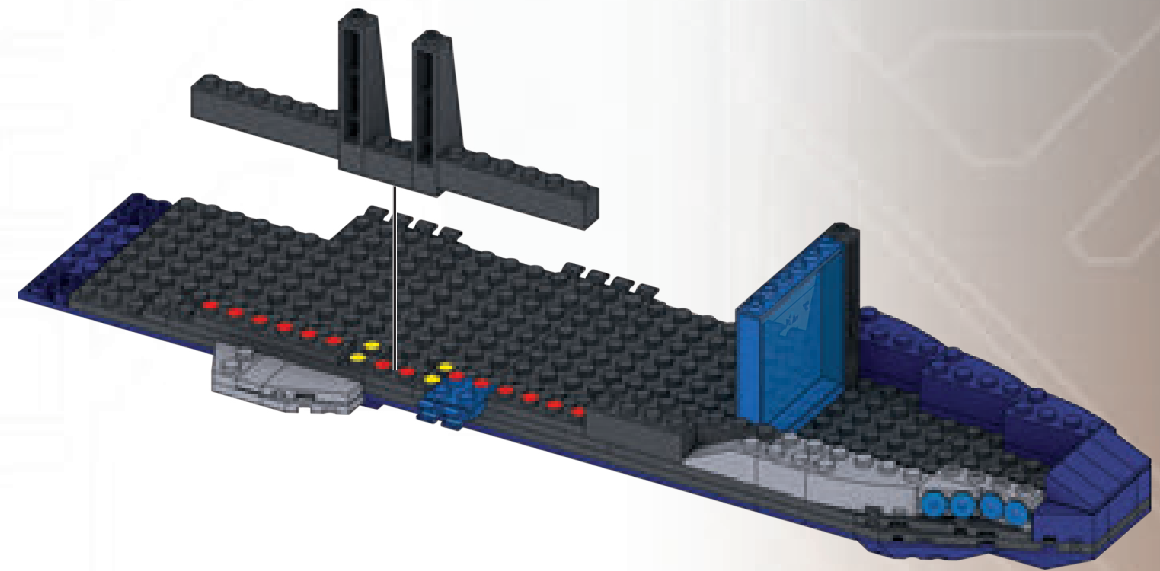
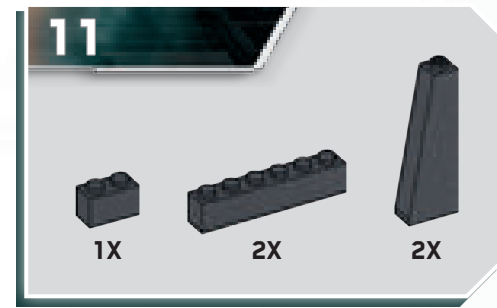
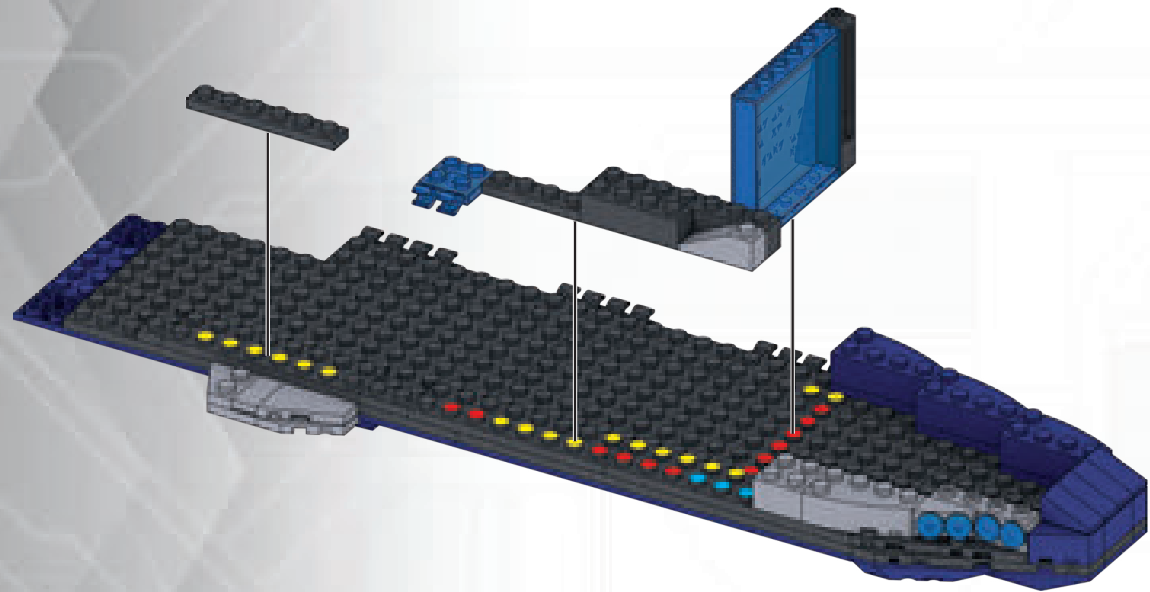
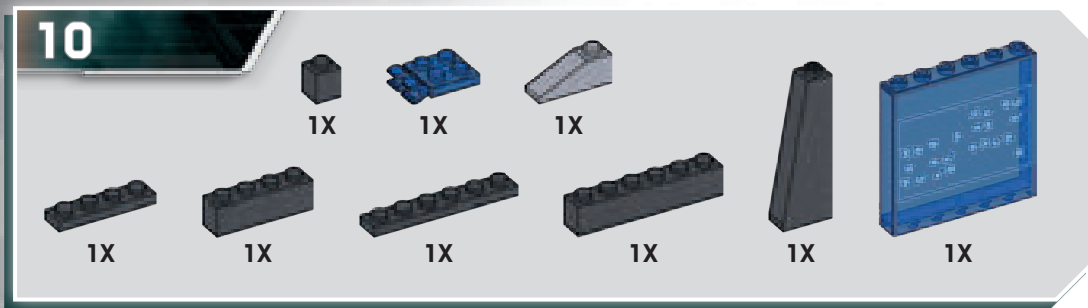

14

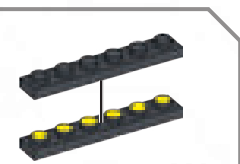

X2

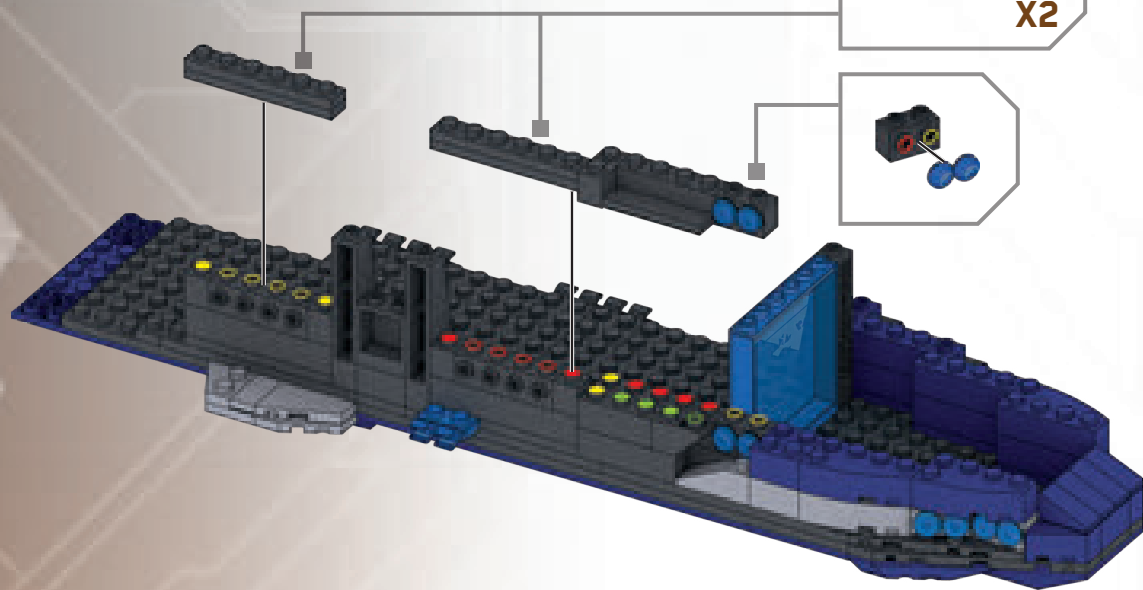
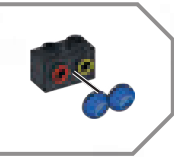

15

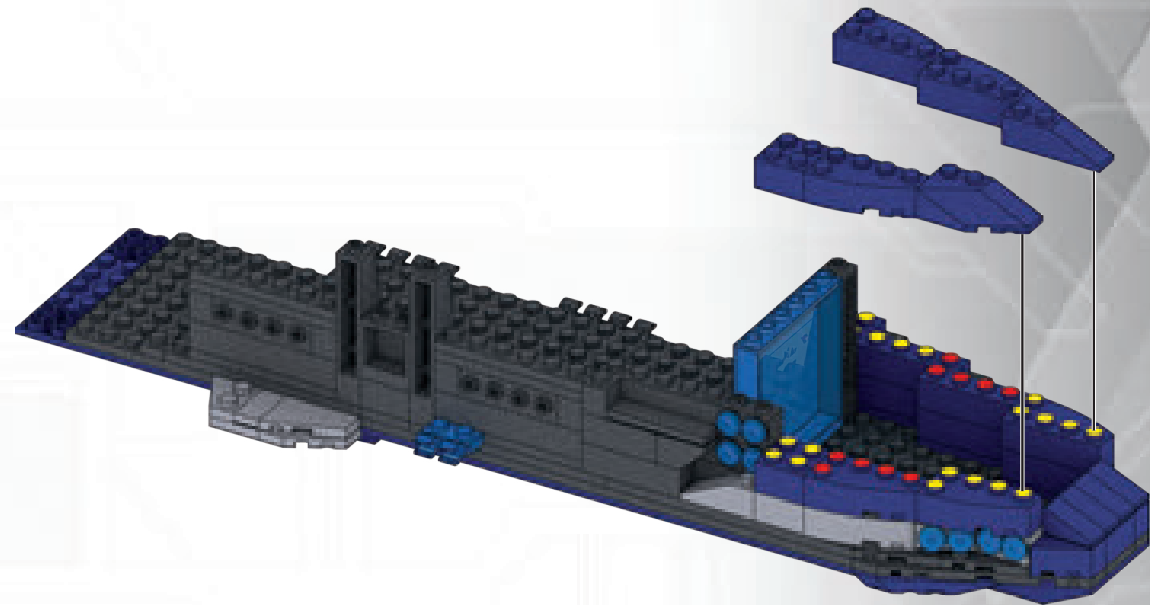

16

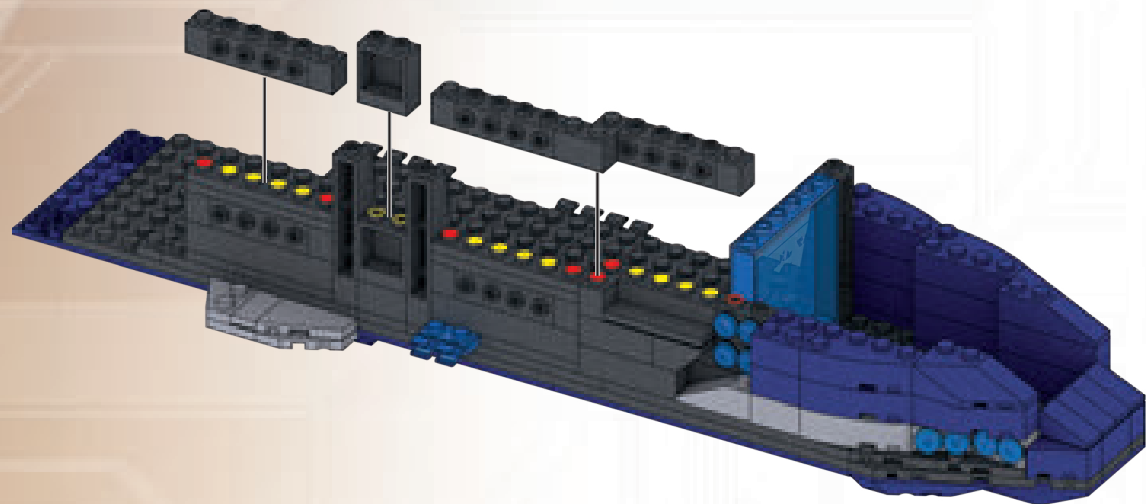

17

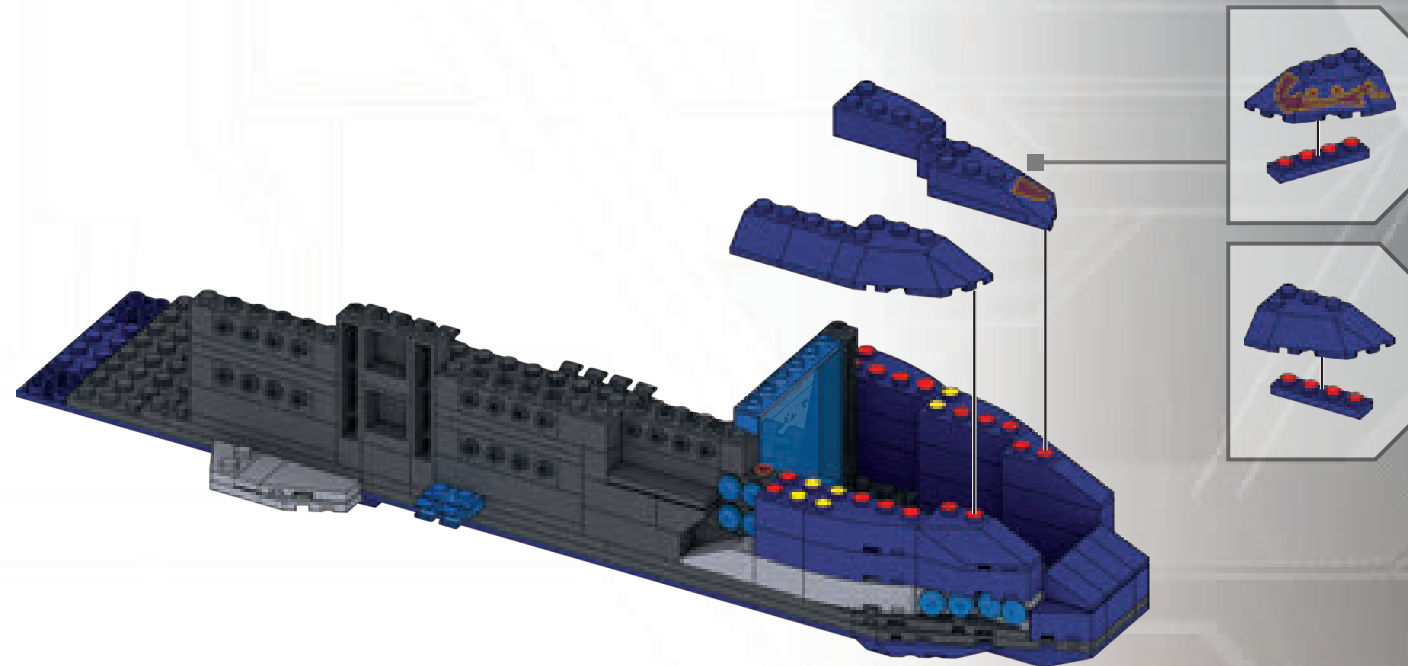

2

**18**

1X 1X  
2X 1X

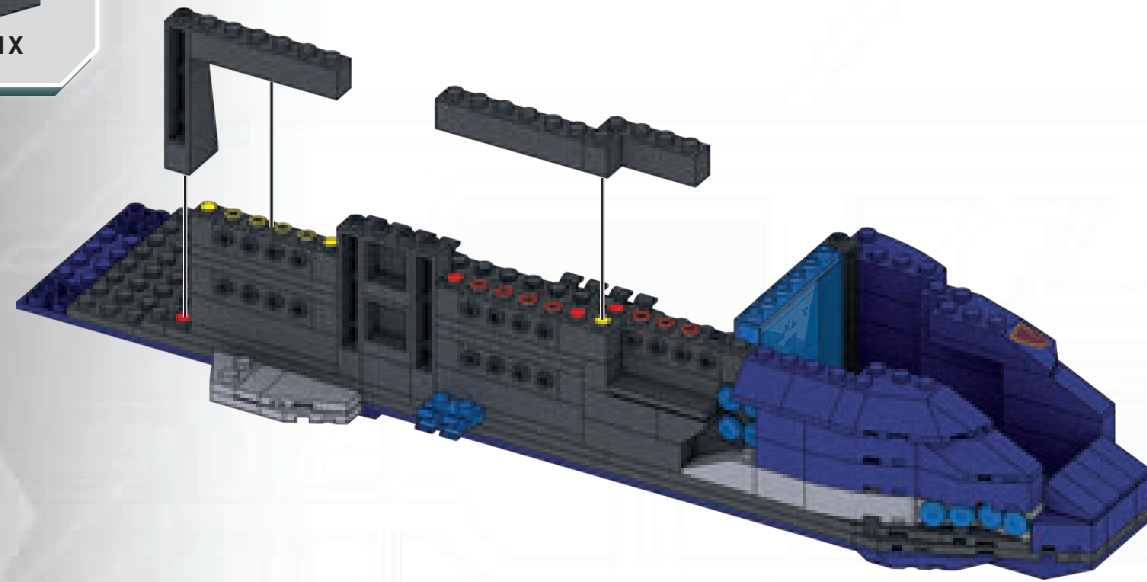

**19**

4X 1X 1X 1X 1X 1X

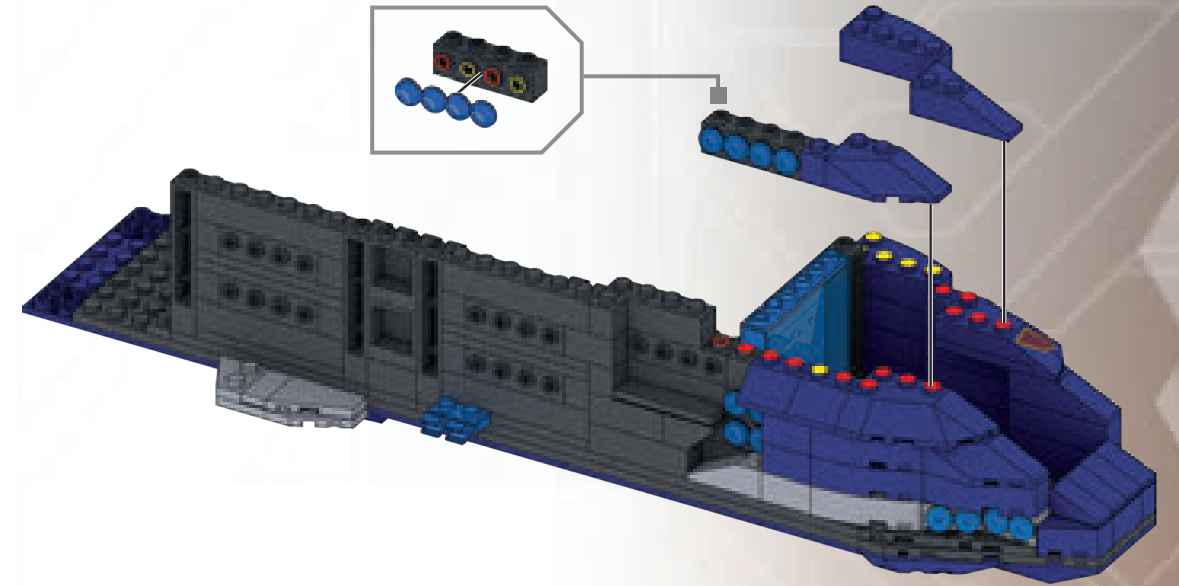

**20**

2X 1X 1X 1X 1X

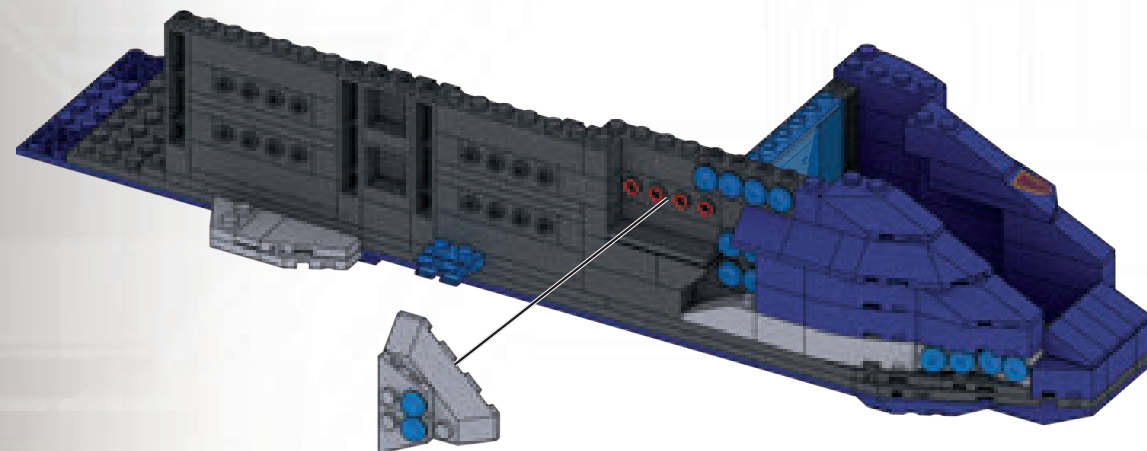
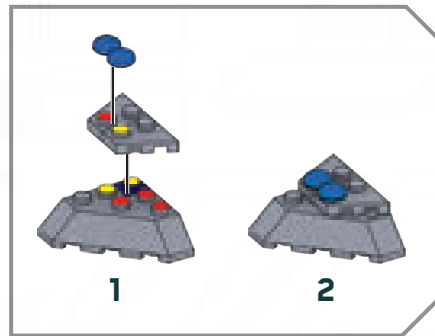

**21**

2X 1X

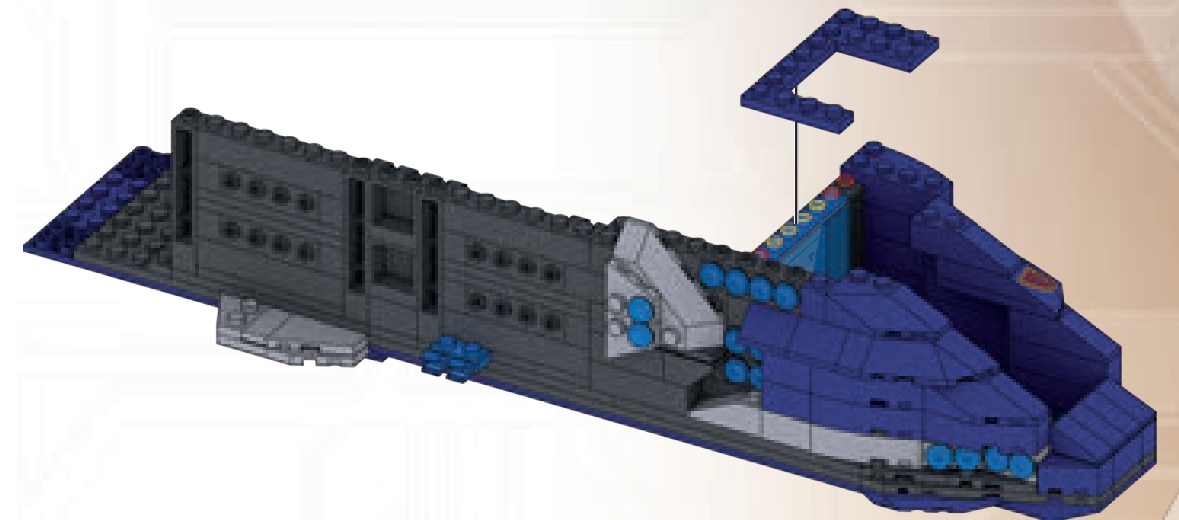

22

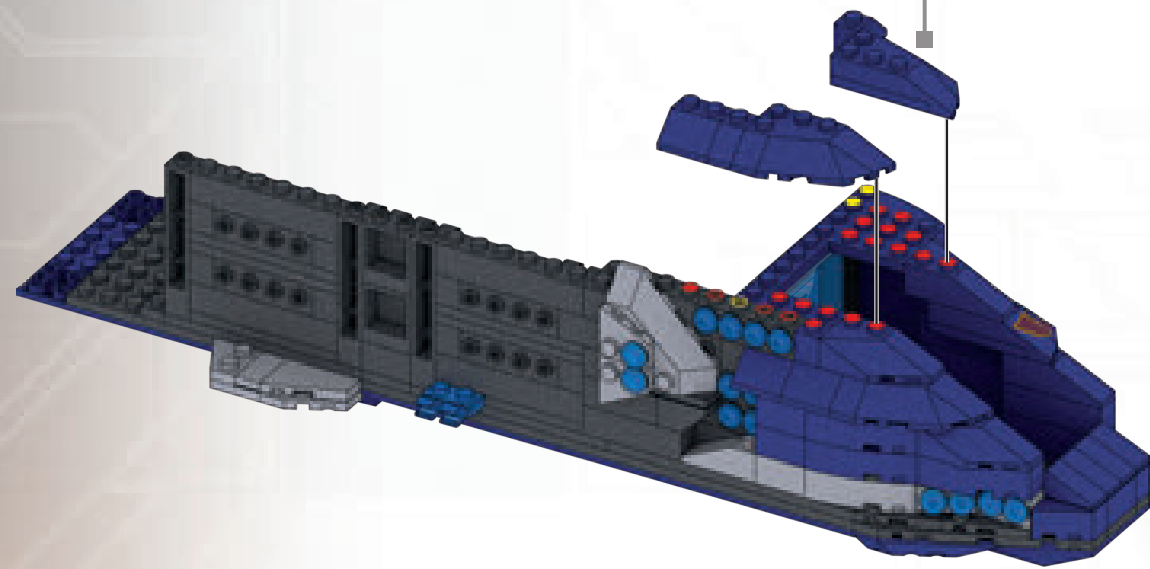
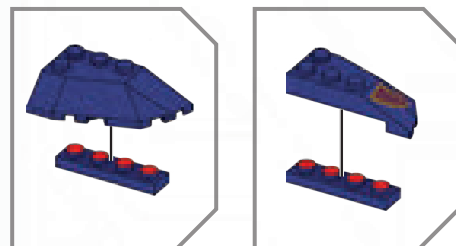
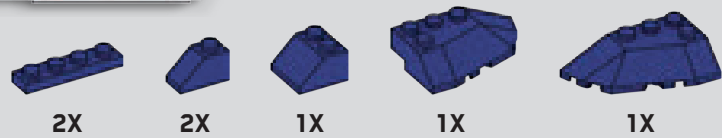

1

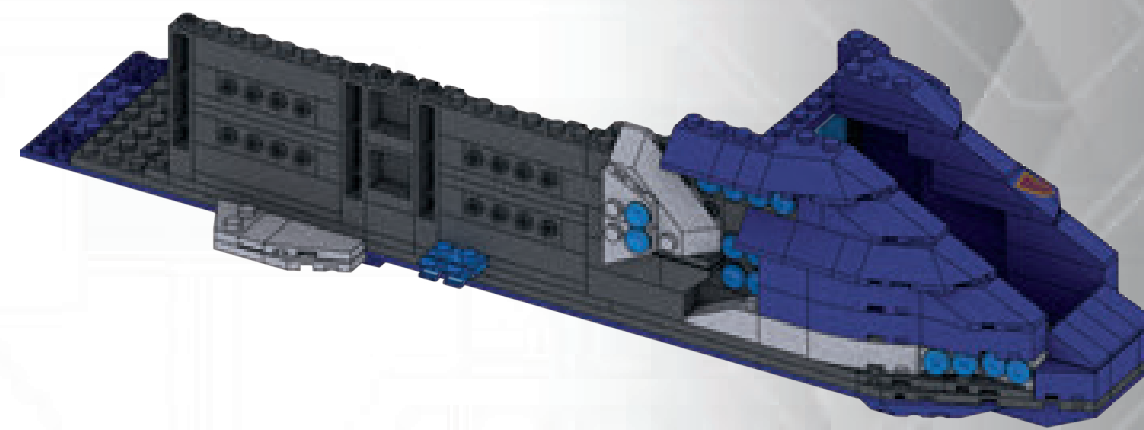

2

23

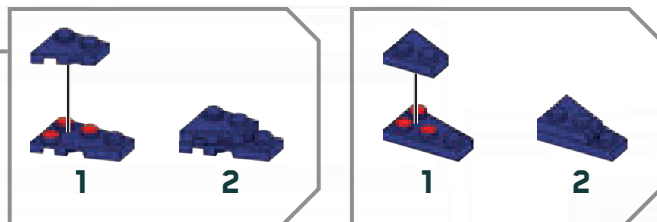
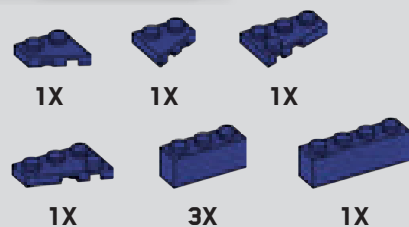

24

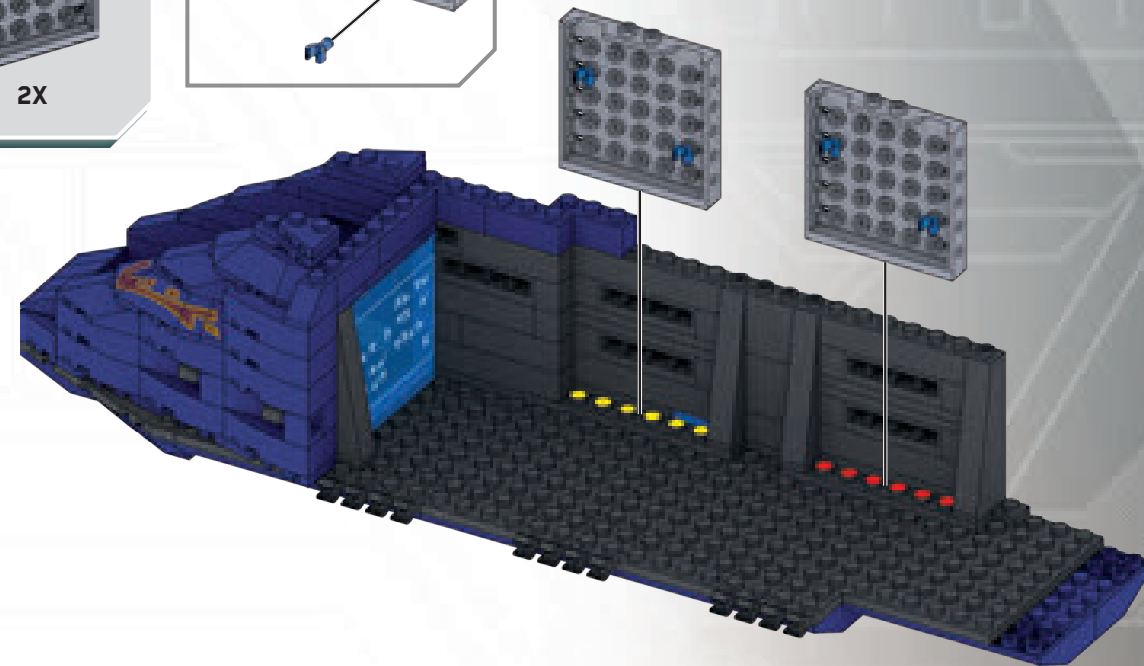
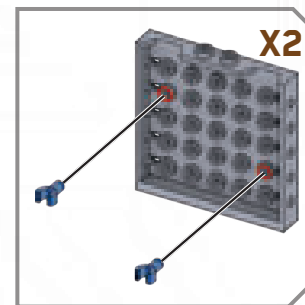
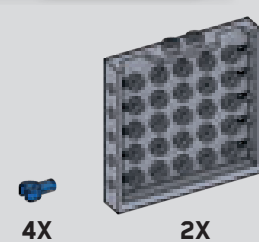

2



**25**

2X 1X

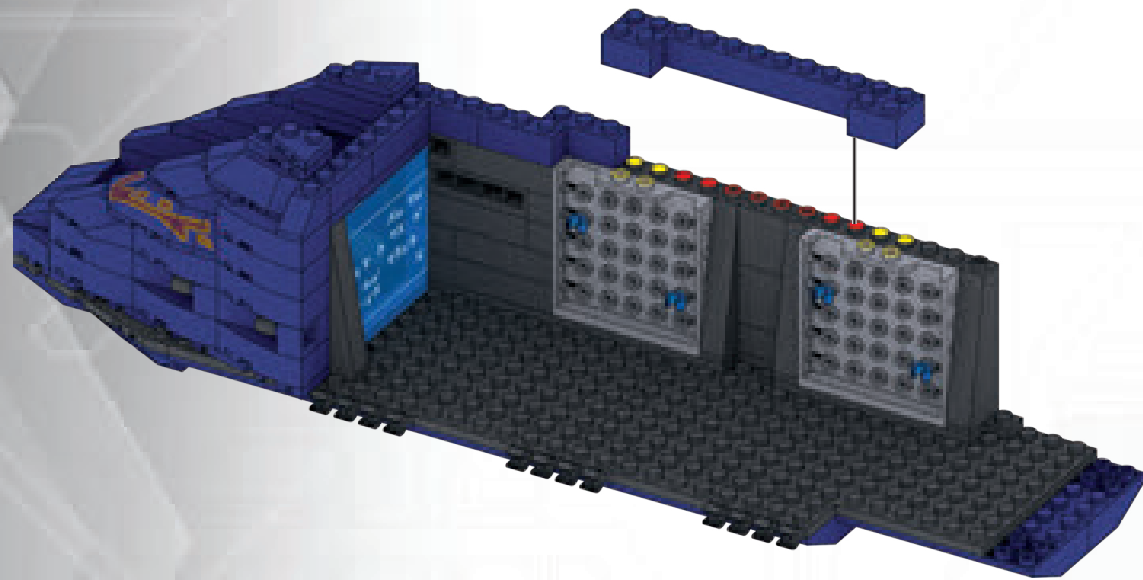

1

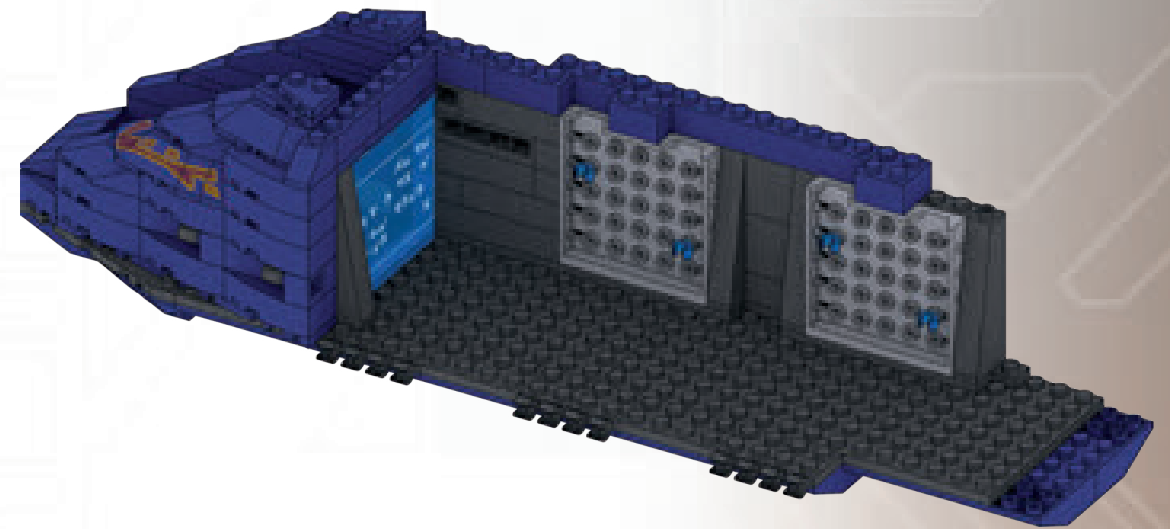

2

2

**26**

1X 2X  
1X 1X

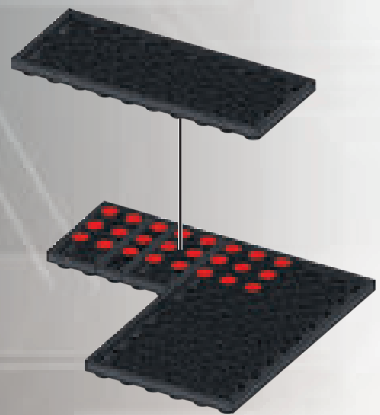

**27**

1X 1X 1X  
1X 1X 1X

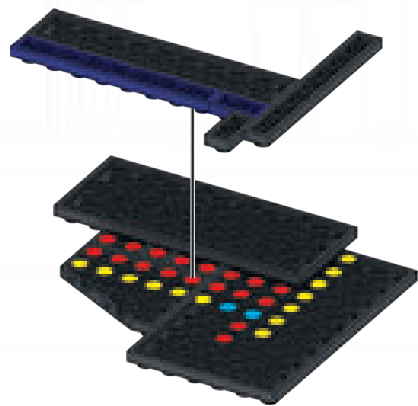

**28**

1X 1X



1



2

29

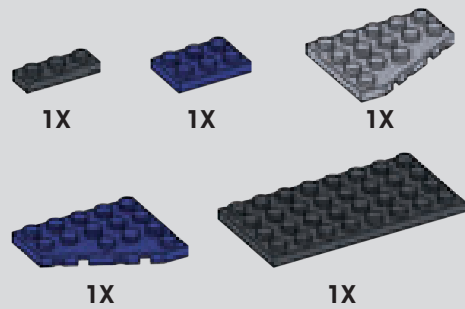

30



31

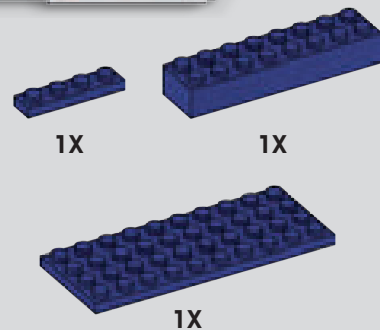

32

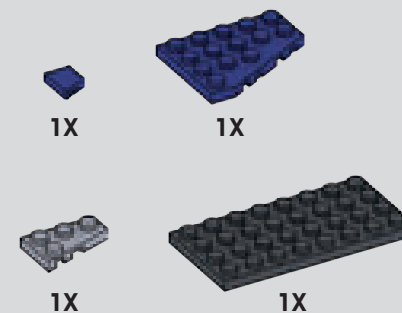

2

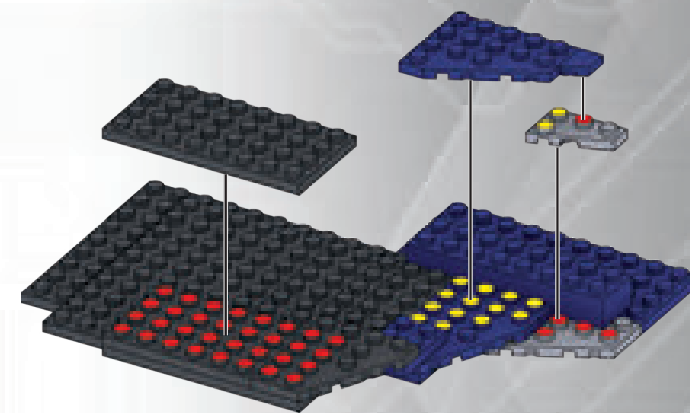
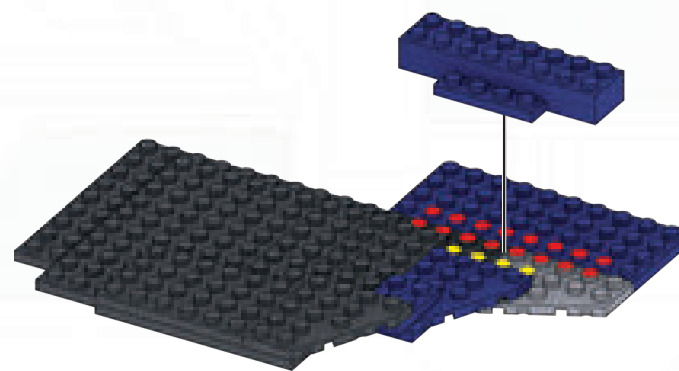
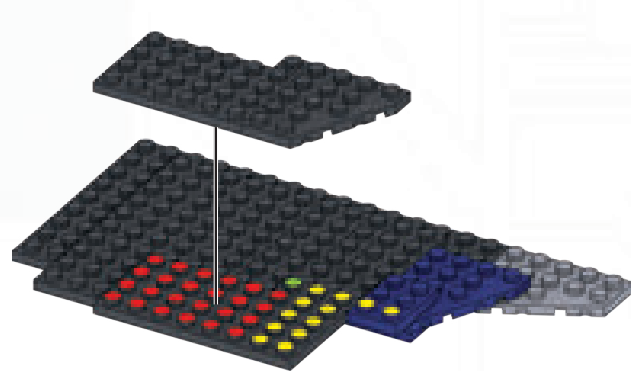
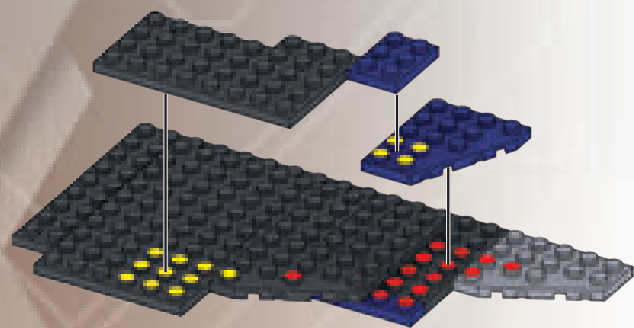

33



34

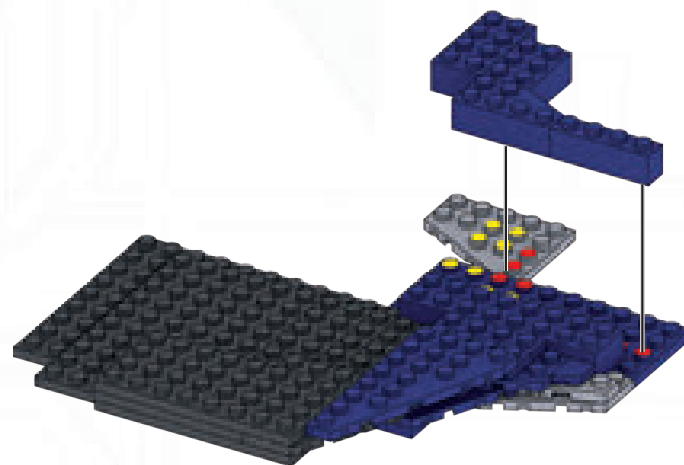
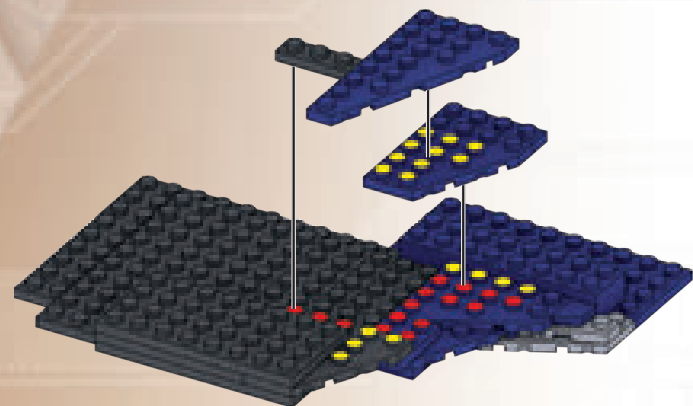
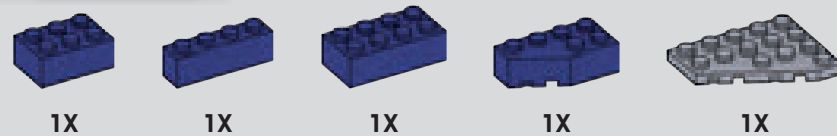

1

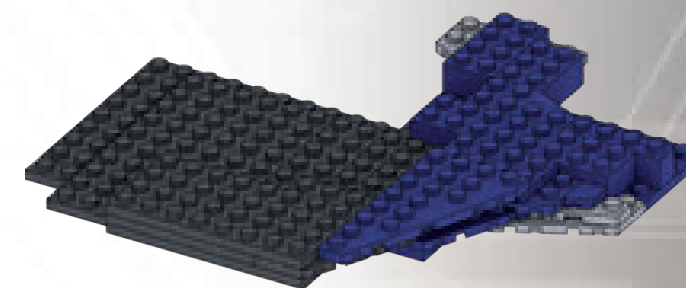

2

34

35

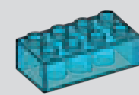

1X



1X



1X

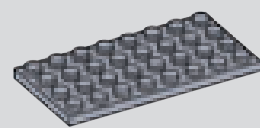

1X

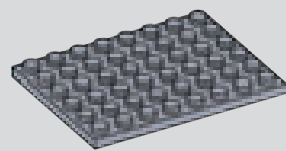

1X

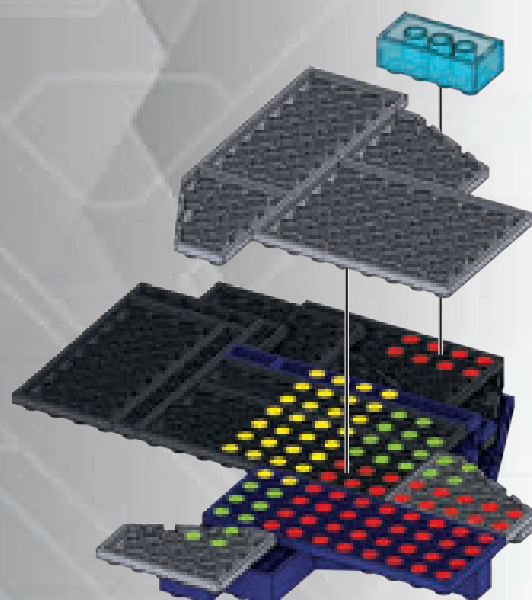

1

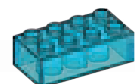

Place temporary piece  
 Placer la pièce temporaire  
 Colocar a peça provisória  
 Colocar a peça provisória  
 Posizionare il pezzo provvisorio  
 Das vorübergehend benötigte Teil platzieren  
 Umieść tymczasowy element  
 Plaats tijdelijk deel  
 Поместите временную деталь  
 Placer midlertidigt stykke.  
 Placera temporär del  
 Plasser midlertidig del  
 Aseta väliaikainen osa  
 Τοποθετήστε το προσωρινό κομμάτι  
 Geçici parçayı yerleştirin  
 放置临时件  
 暫定ピースを配置してください  
 ضع القطعة المؤقتة

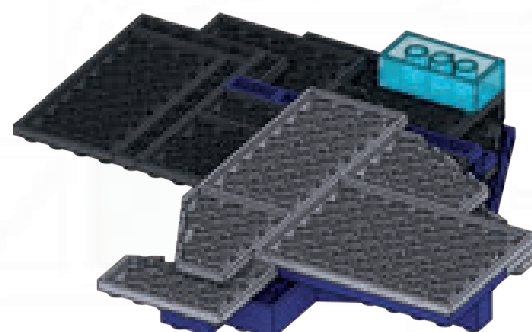

2

36



1X



1X



1X

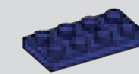

1X



1X

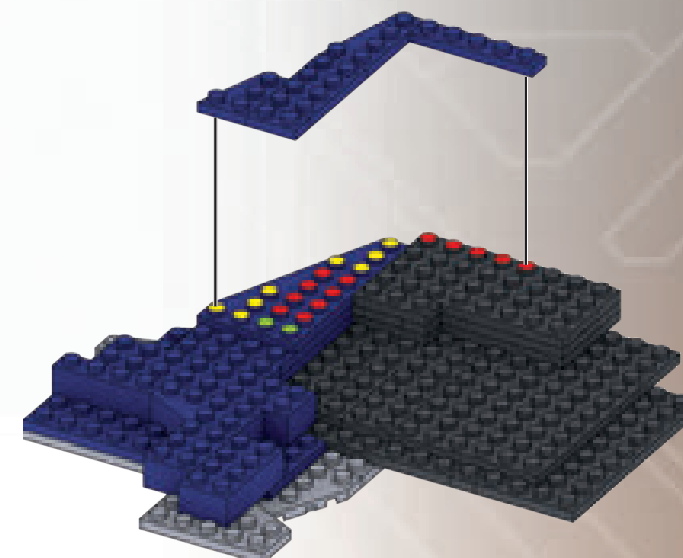

37



1X



2X



1X

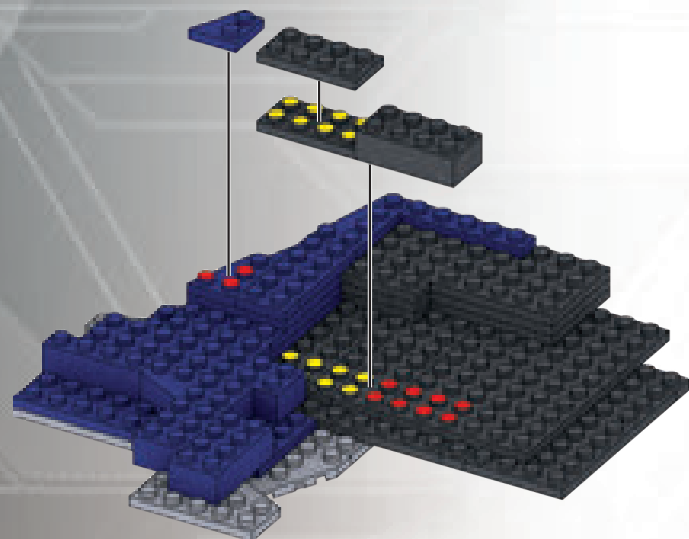

38



1X



1X



1X



1X

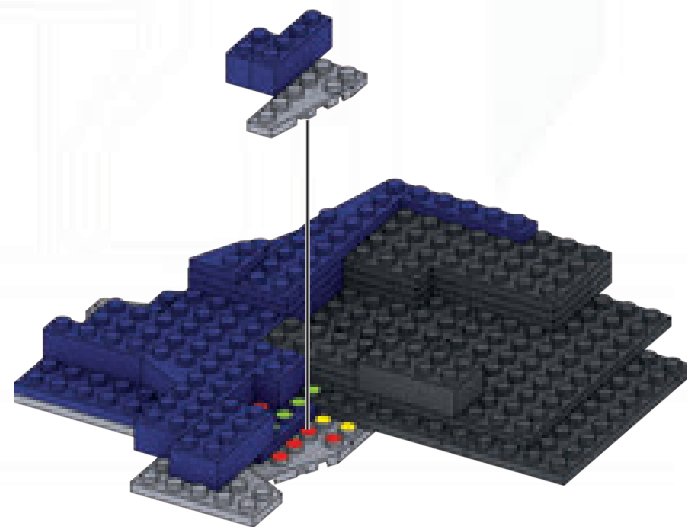

39



1X



1X



1X



1X

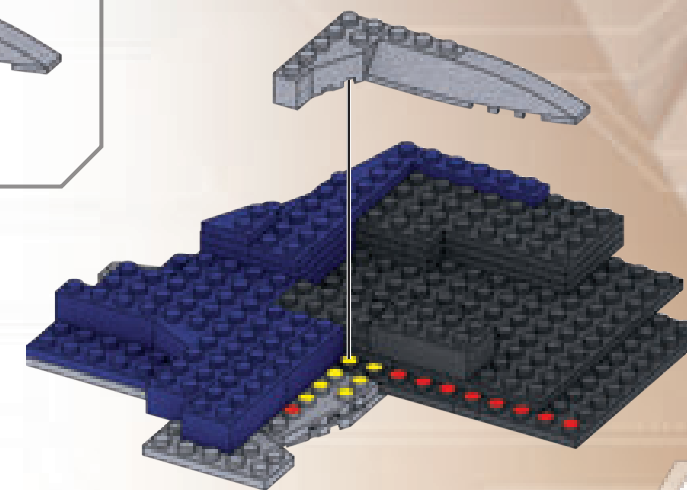
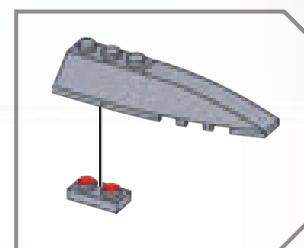

2

40

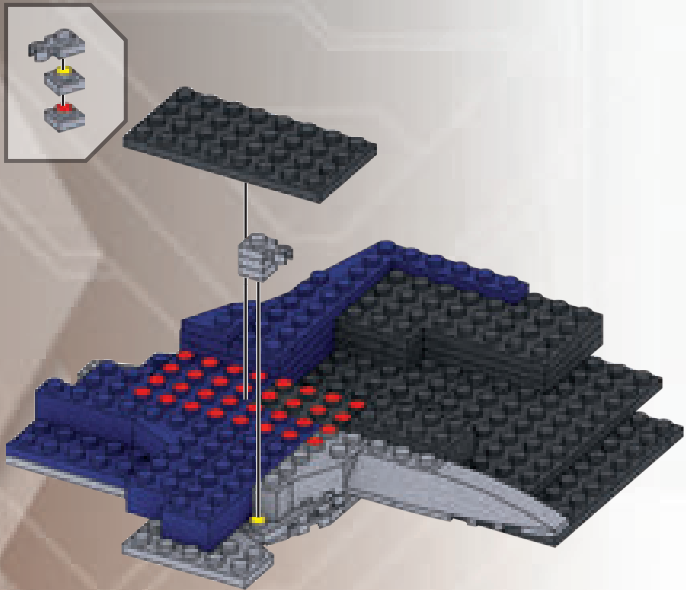

41

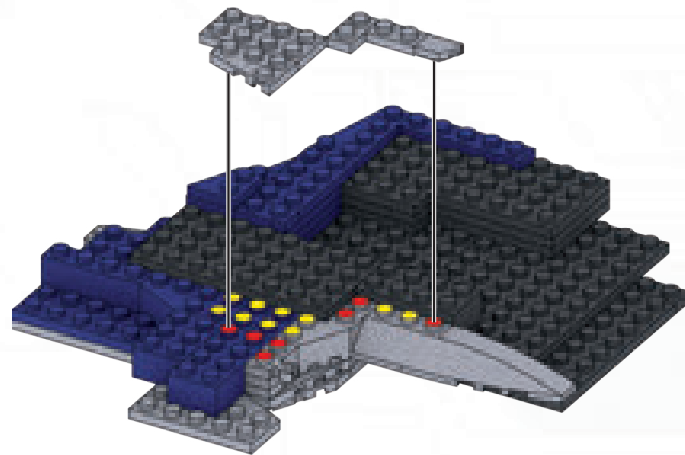

42

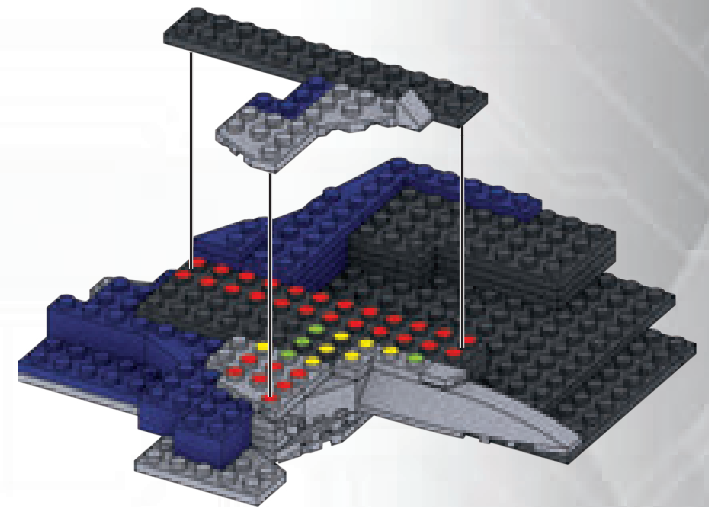
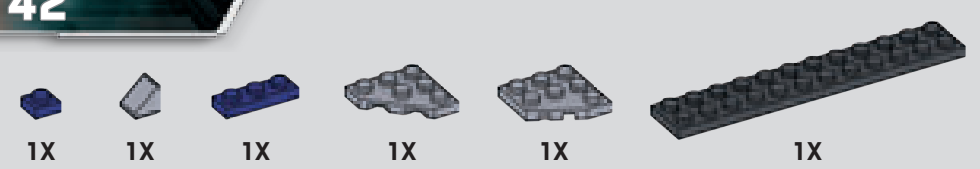

43

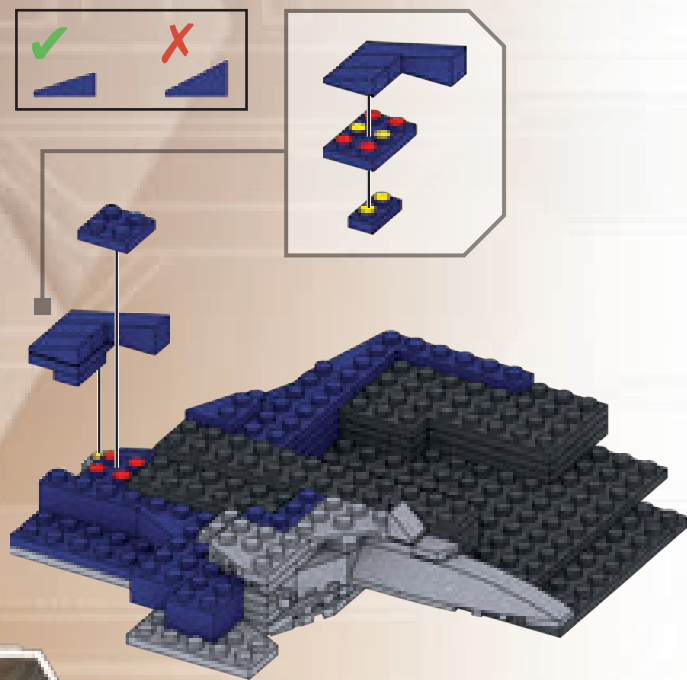
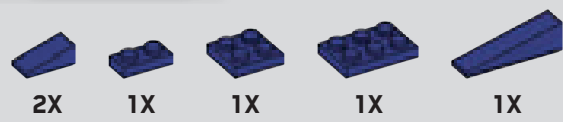

44

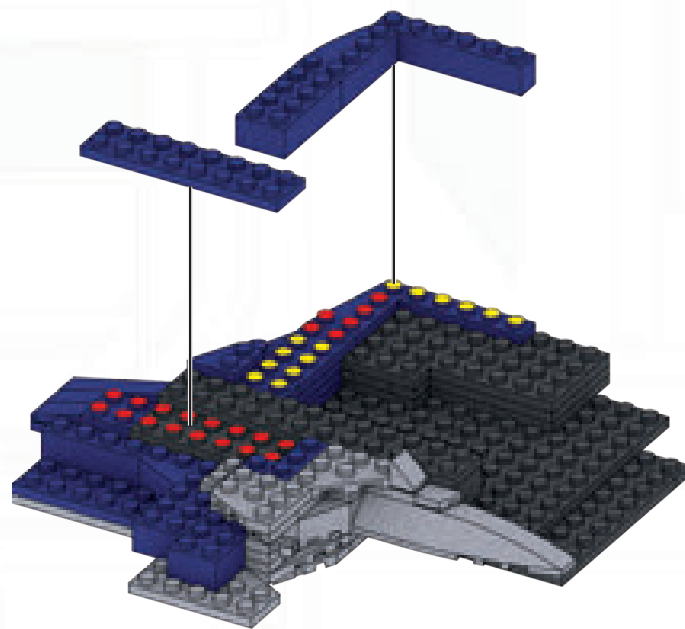
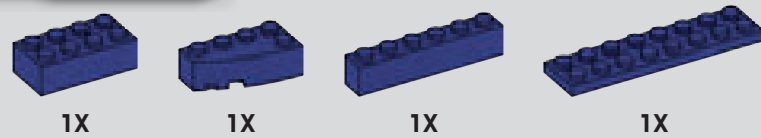

45

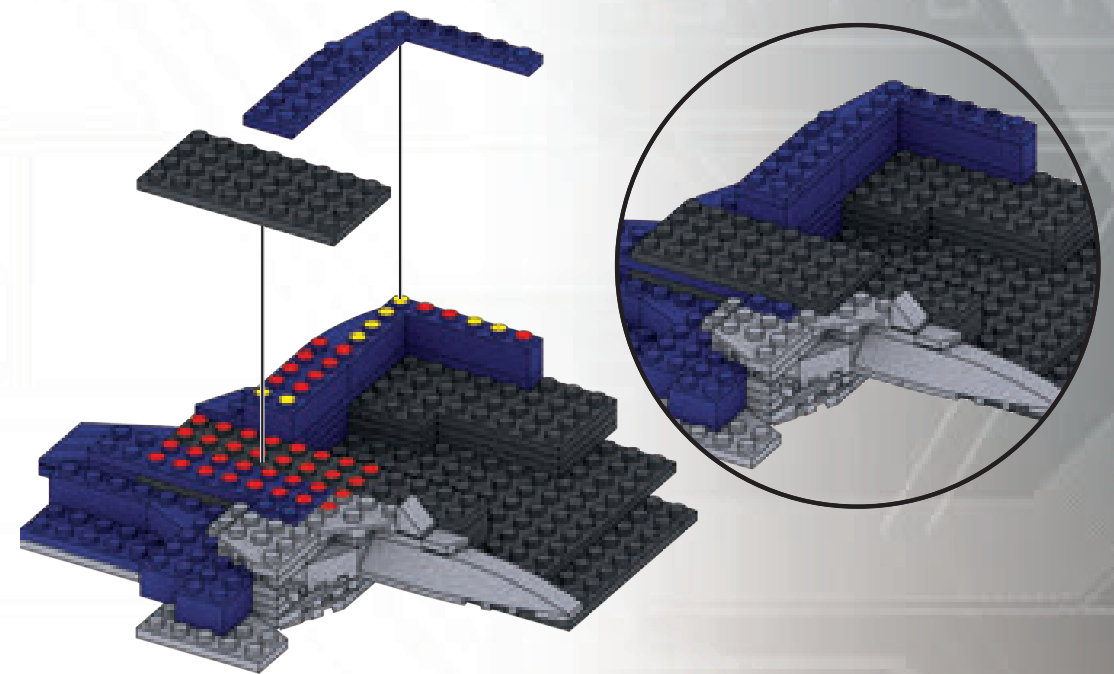

46

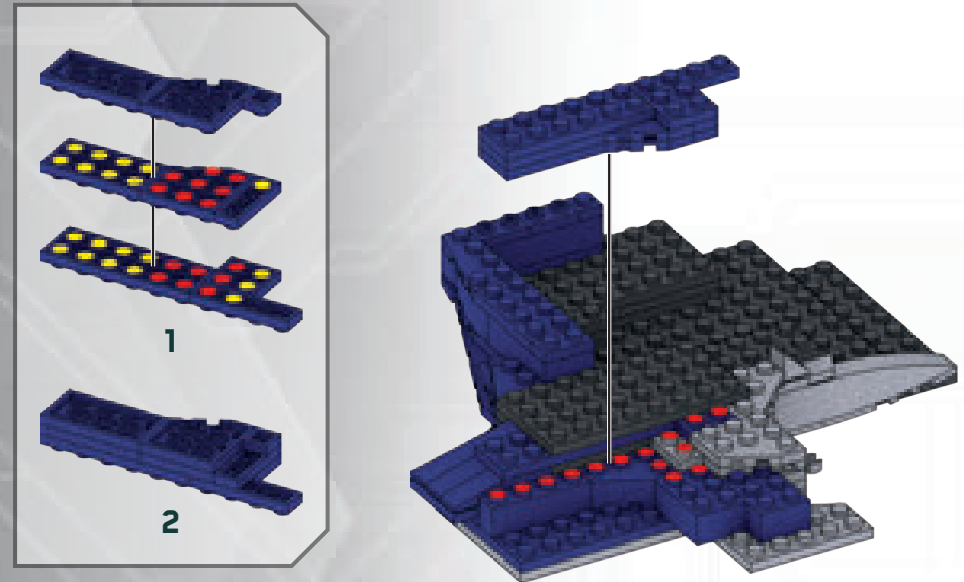
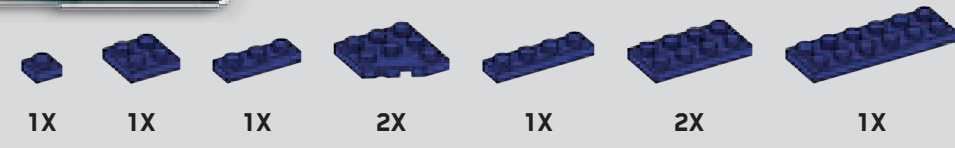

47

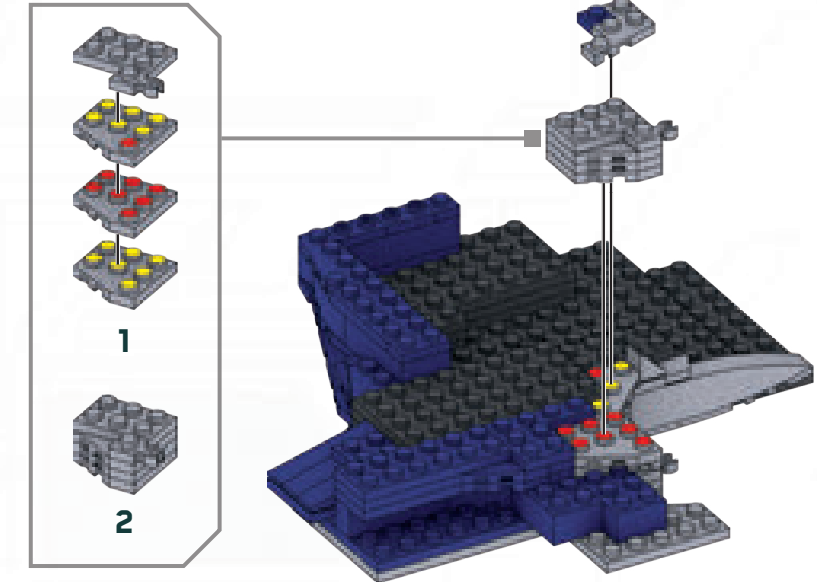

48

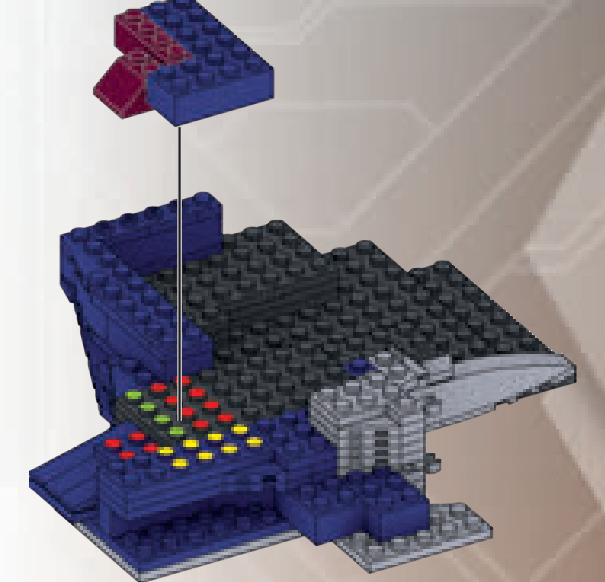
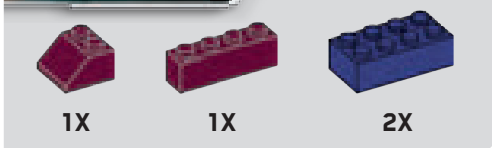

49

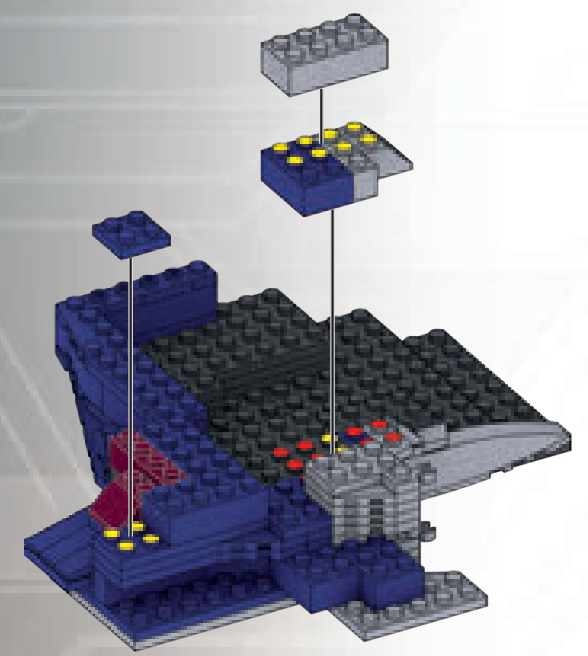
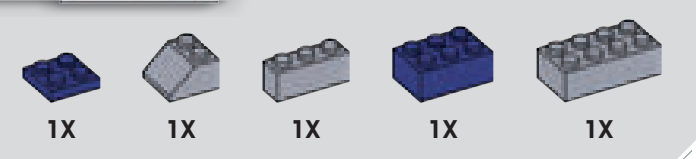

50

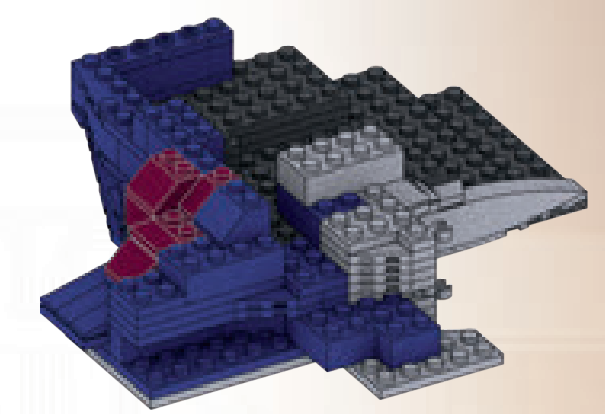
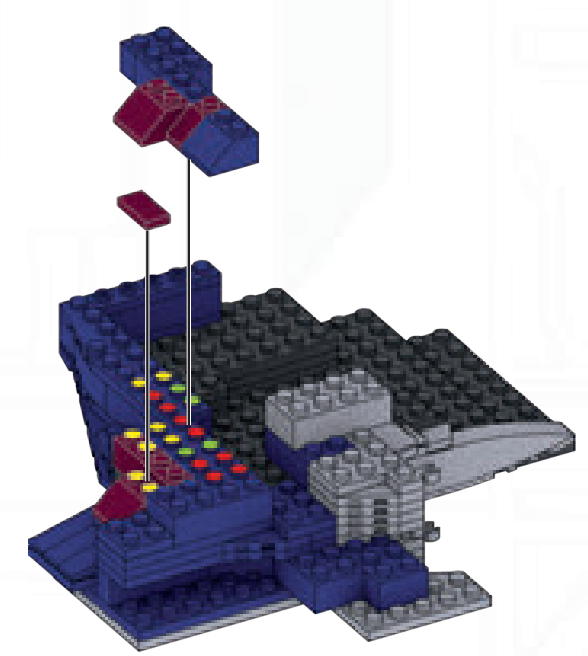
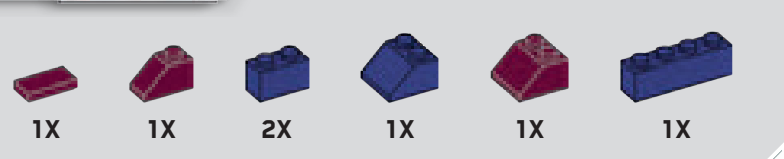

2

51

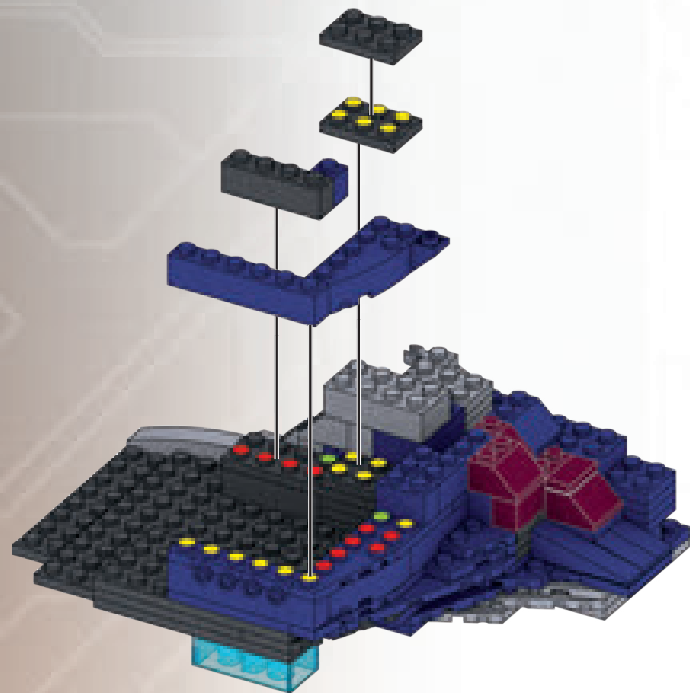

52

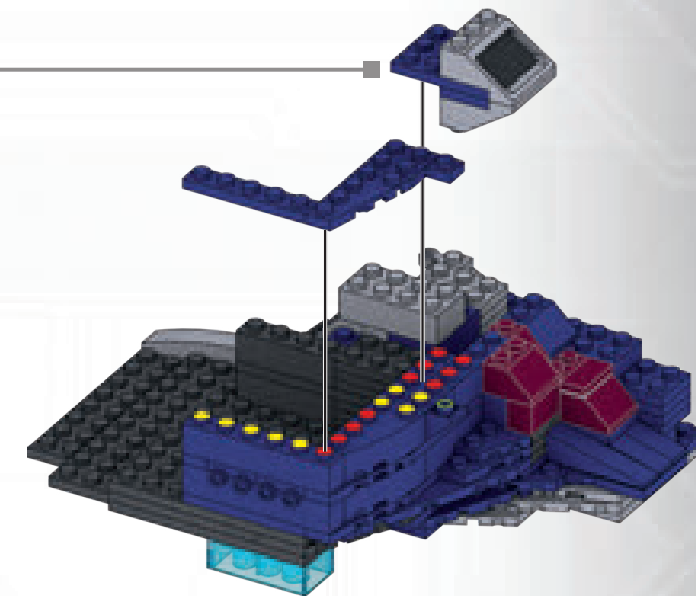
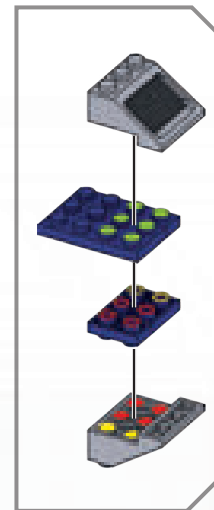
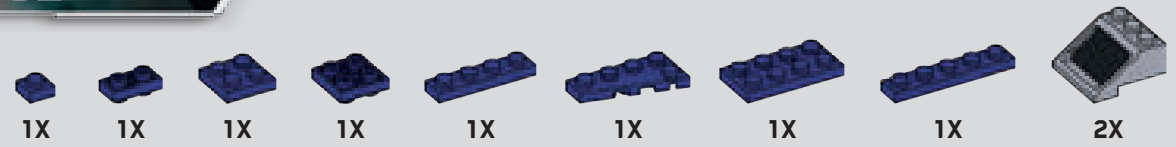

53

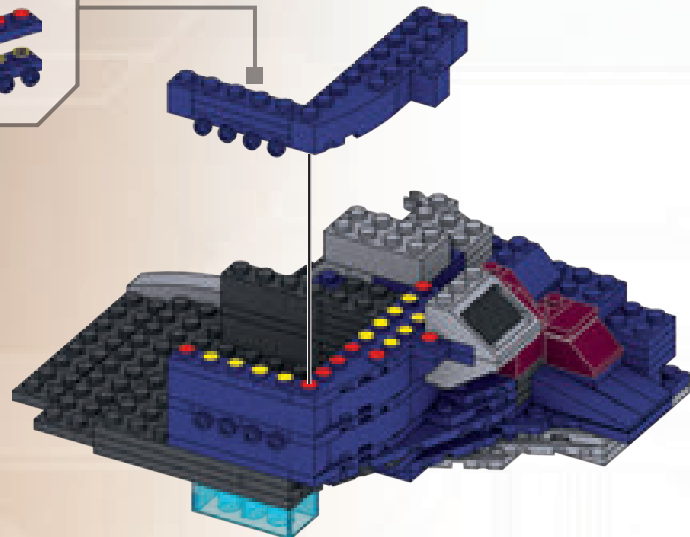
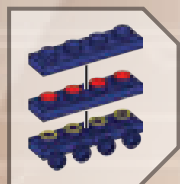

54

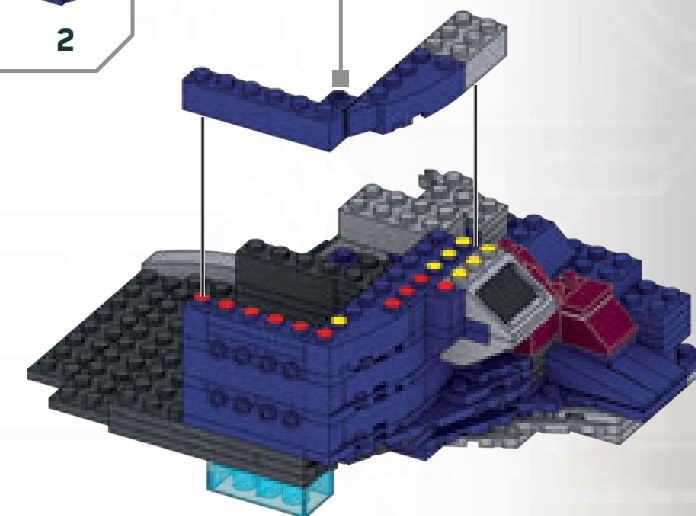
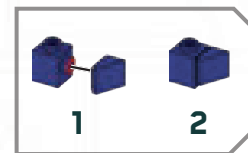
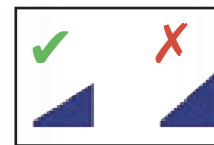

2

55

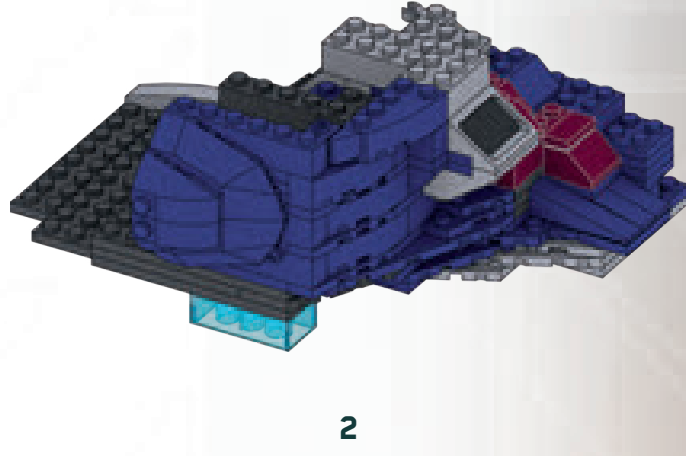
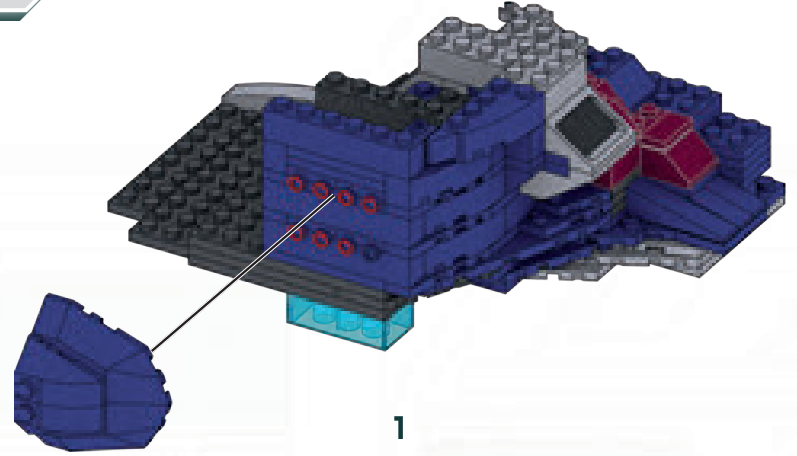
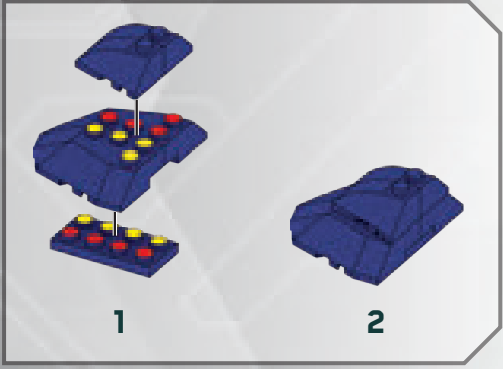
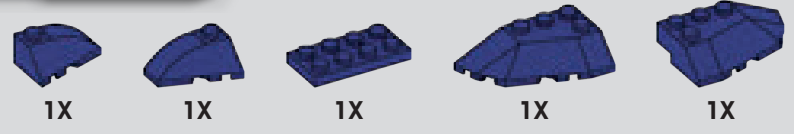

2

56

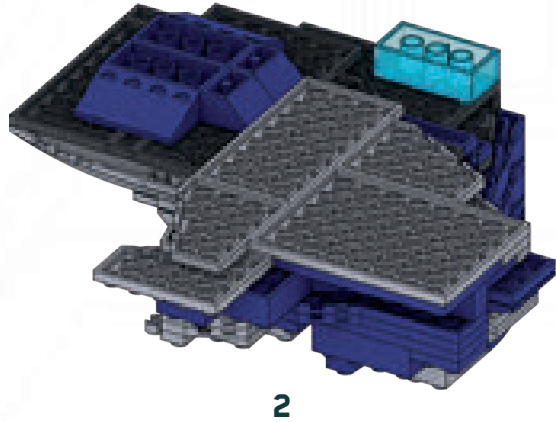
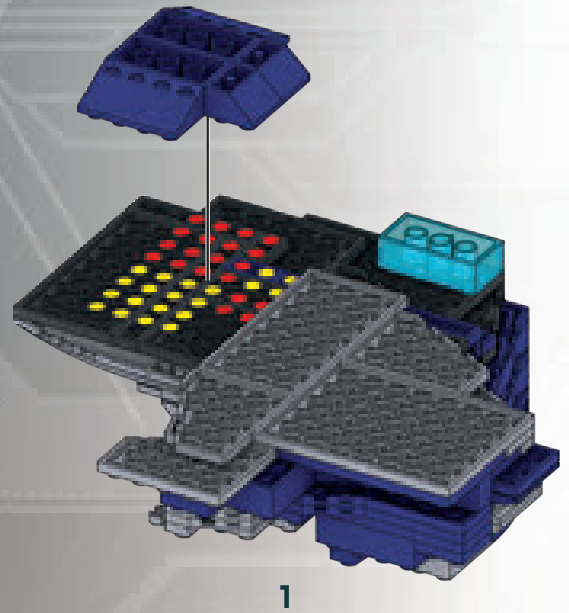
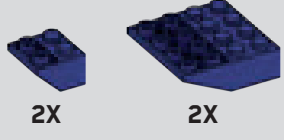

57

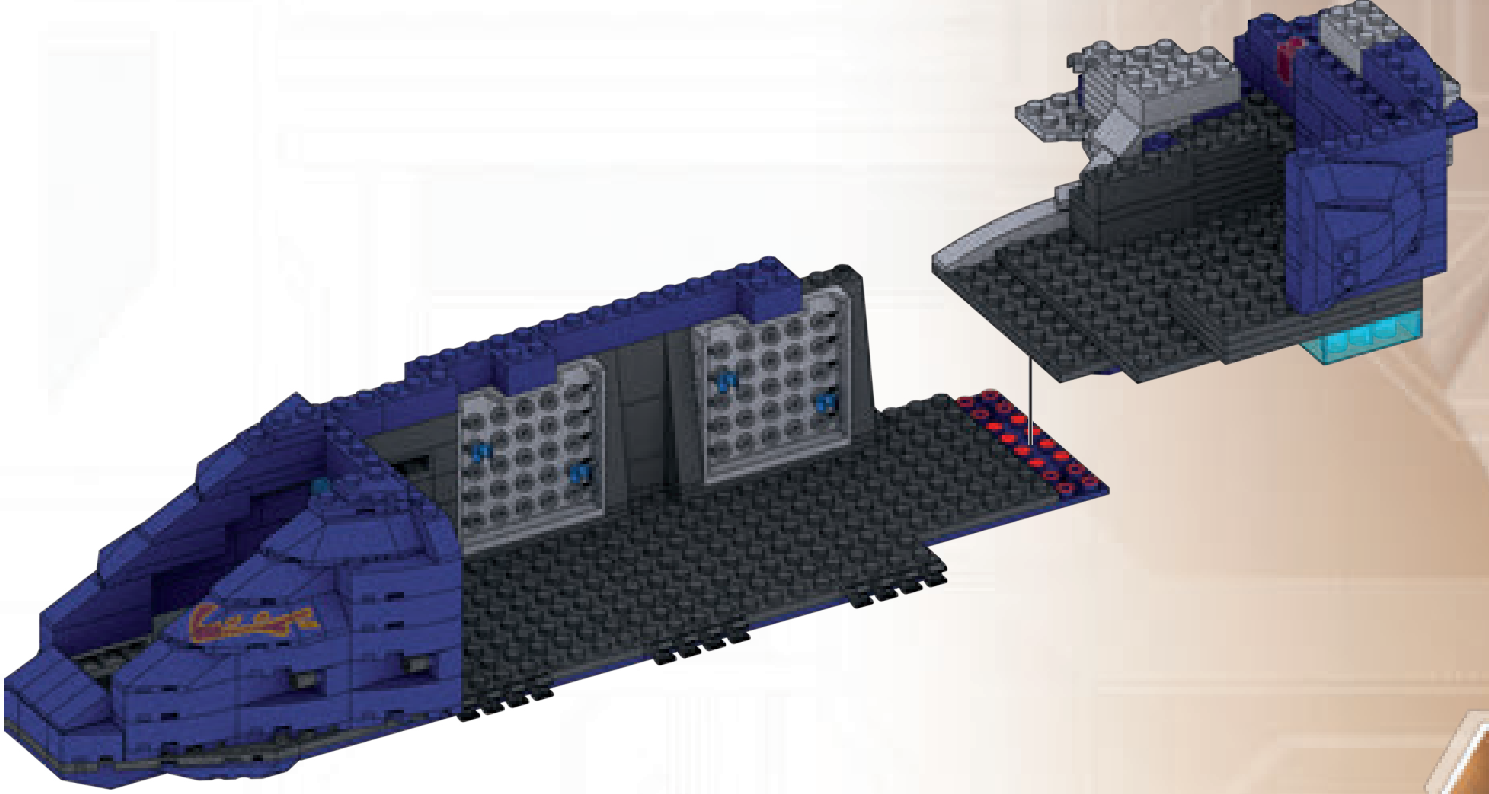

58



1X



1X



1X

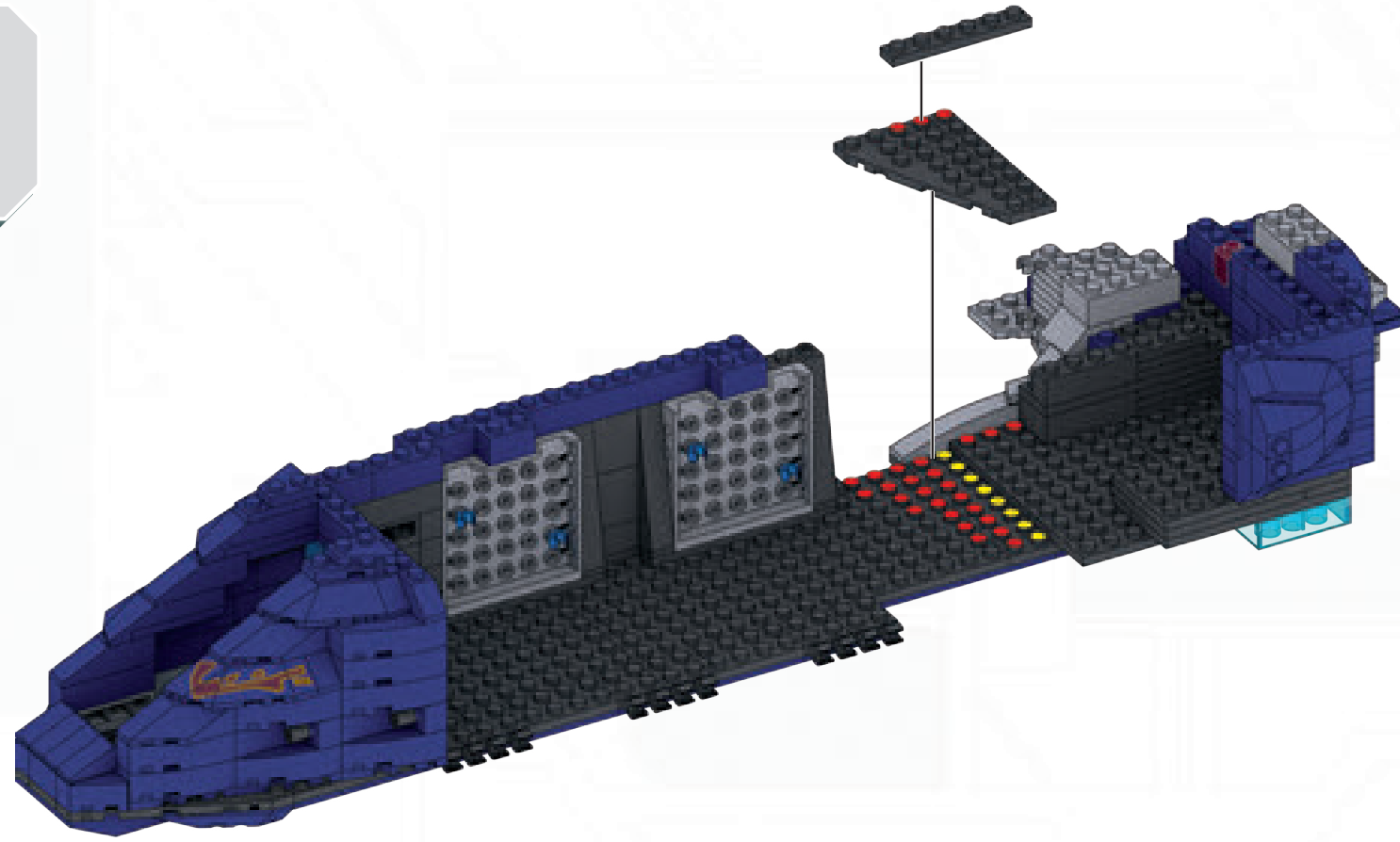

2

59



1X



1X



1X

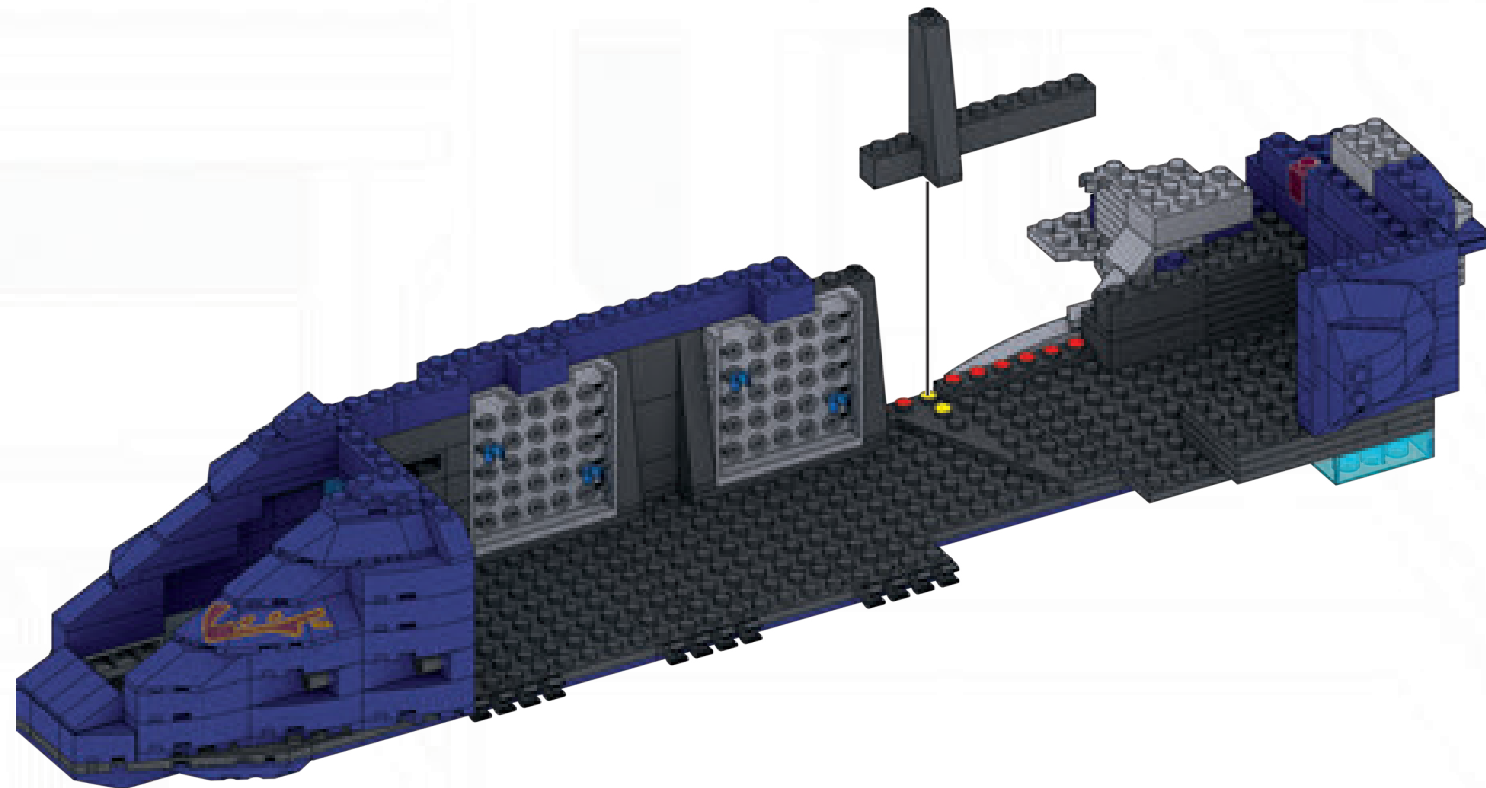



60

- 1X 
- 1X 
- 1X 
- 1X 

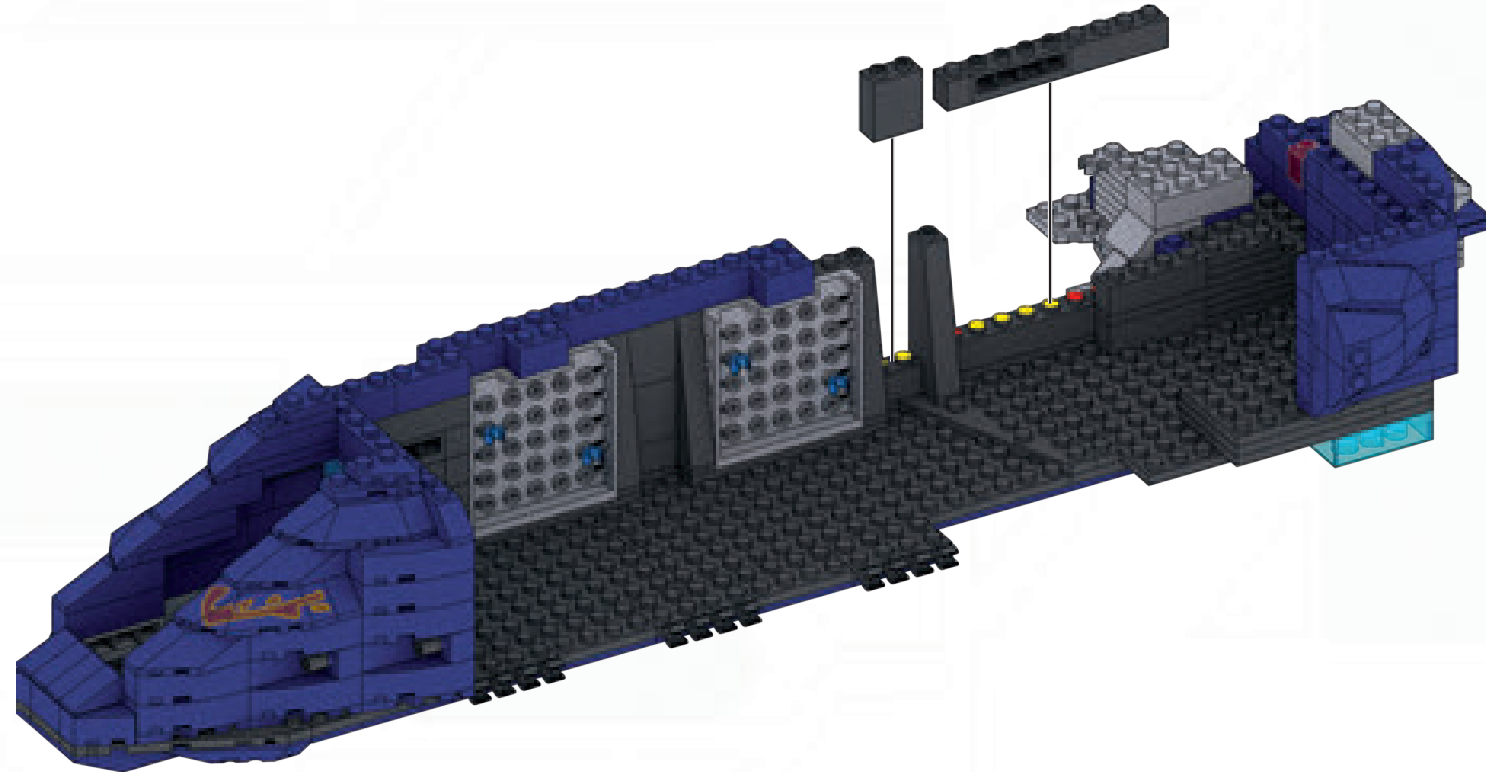

61

- 1X 
- 1X 
- 1X 
- 1X 

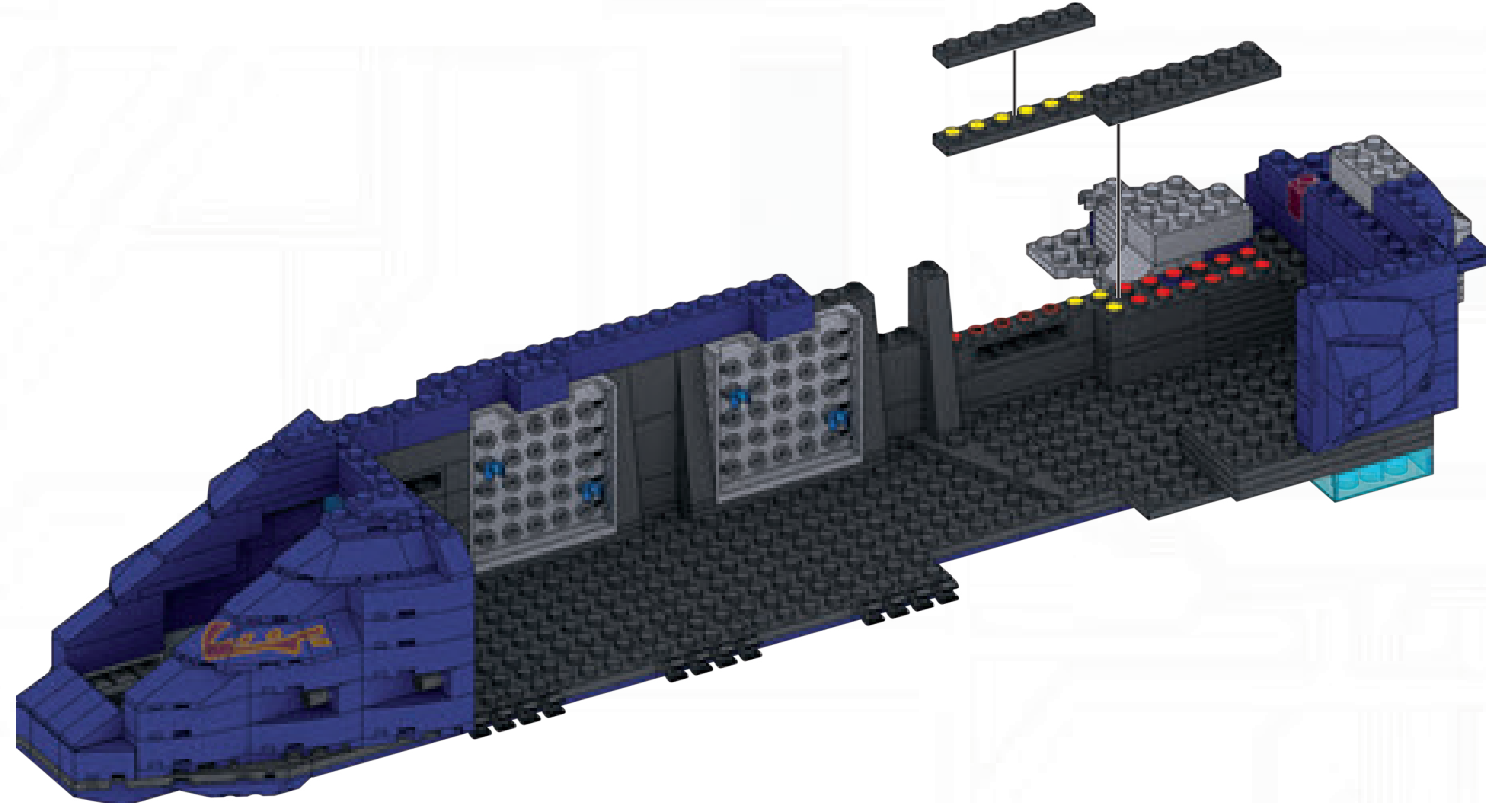

62

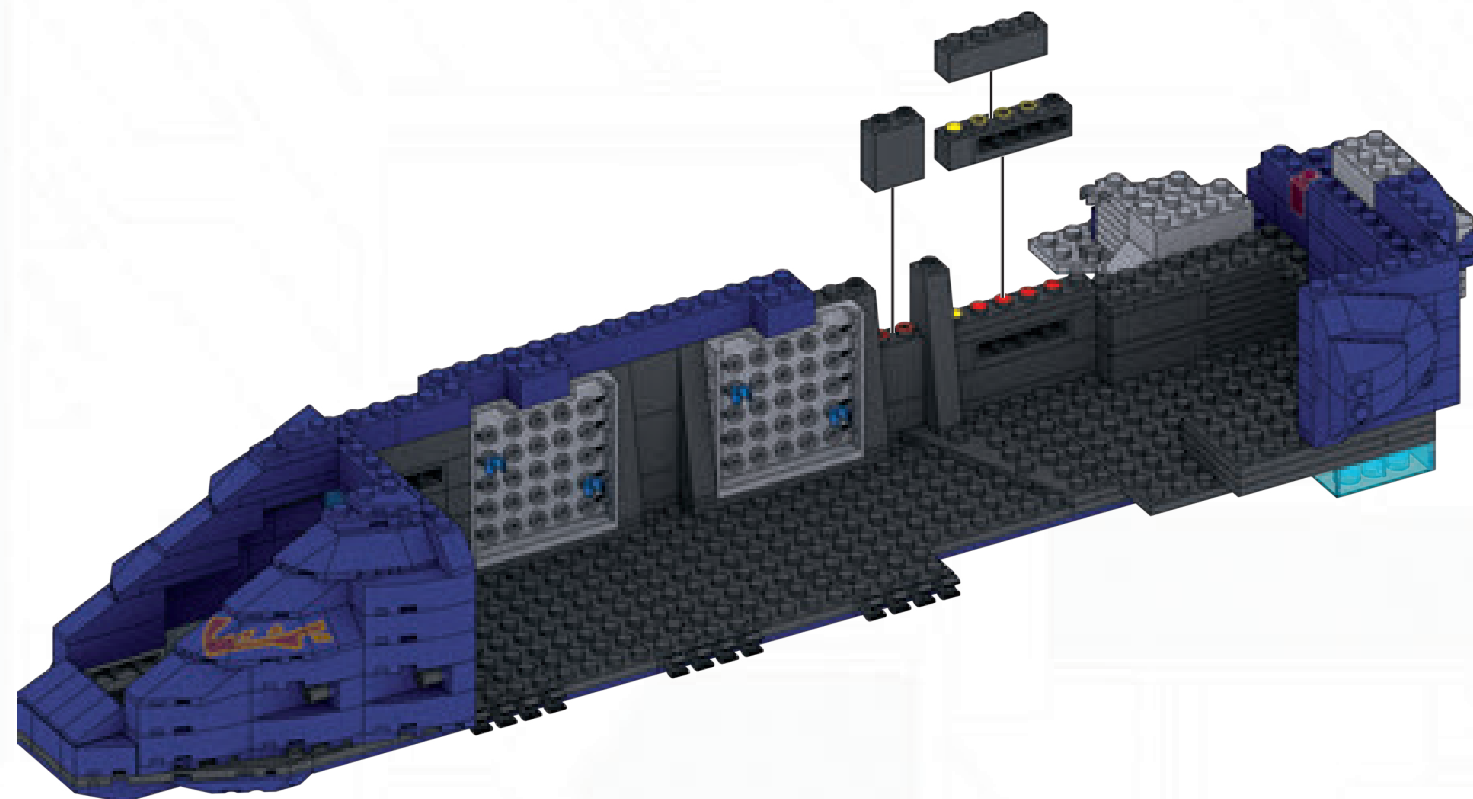

63

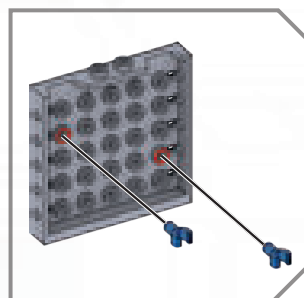
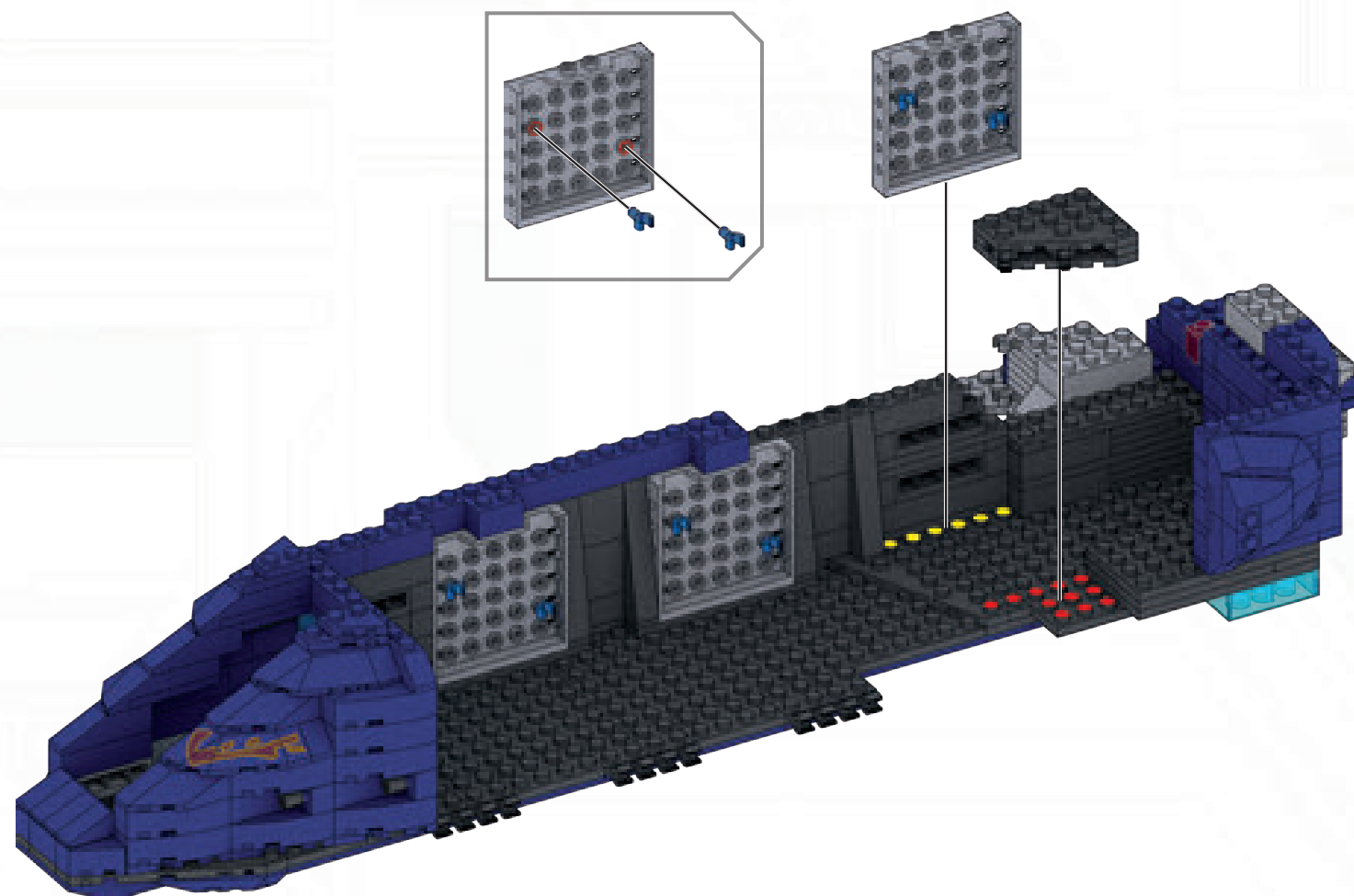
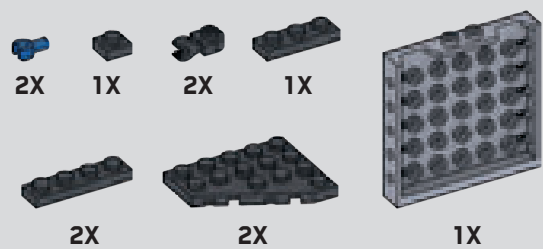

2

**64**

1X      1X

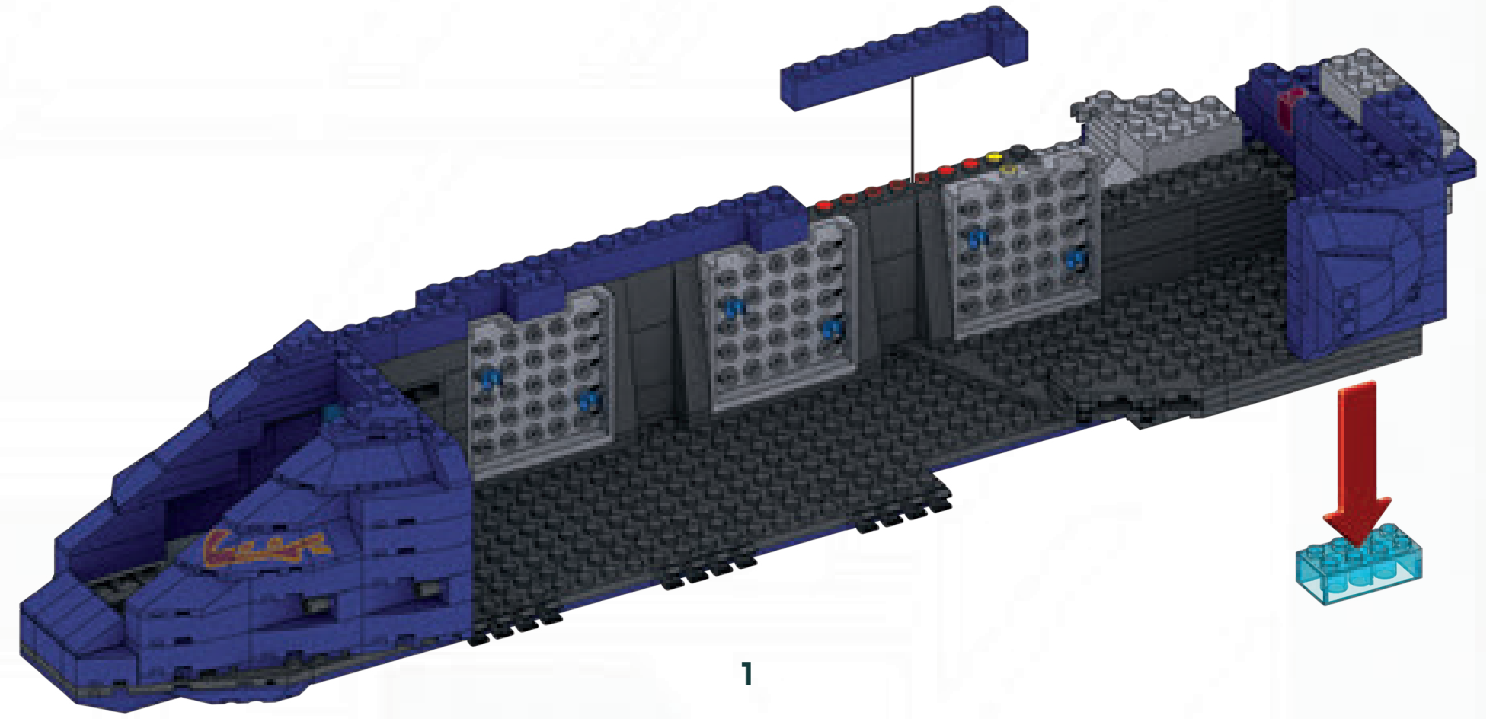
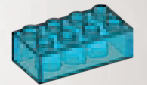
Remove temporary piece  
 Retirez la pièce temporaire  
 Retirar pieza temporal  
 Remova peça temporária  
 Rimuovere il pezzo temporaneo  
 Vorübergehendes Teil entfernen  
 Usunąć element tymczasowy.  
 Verwijder tijdelijke bouwsteen  
 Снимите временную деталь  
 Fjern midlertidigt stykke.  
 Ta bort temporär del  
 Fjern midlertidig del  
 Poista väliaikainen osa  
 Αφαίρεση προσωρινού κομμάτιού  
 انزع القطعة المؤقتة  
 移除临时件  
 暂定ピースを外してください

**2**



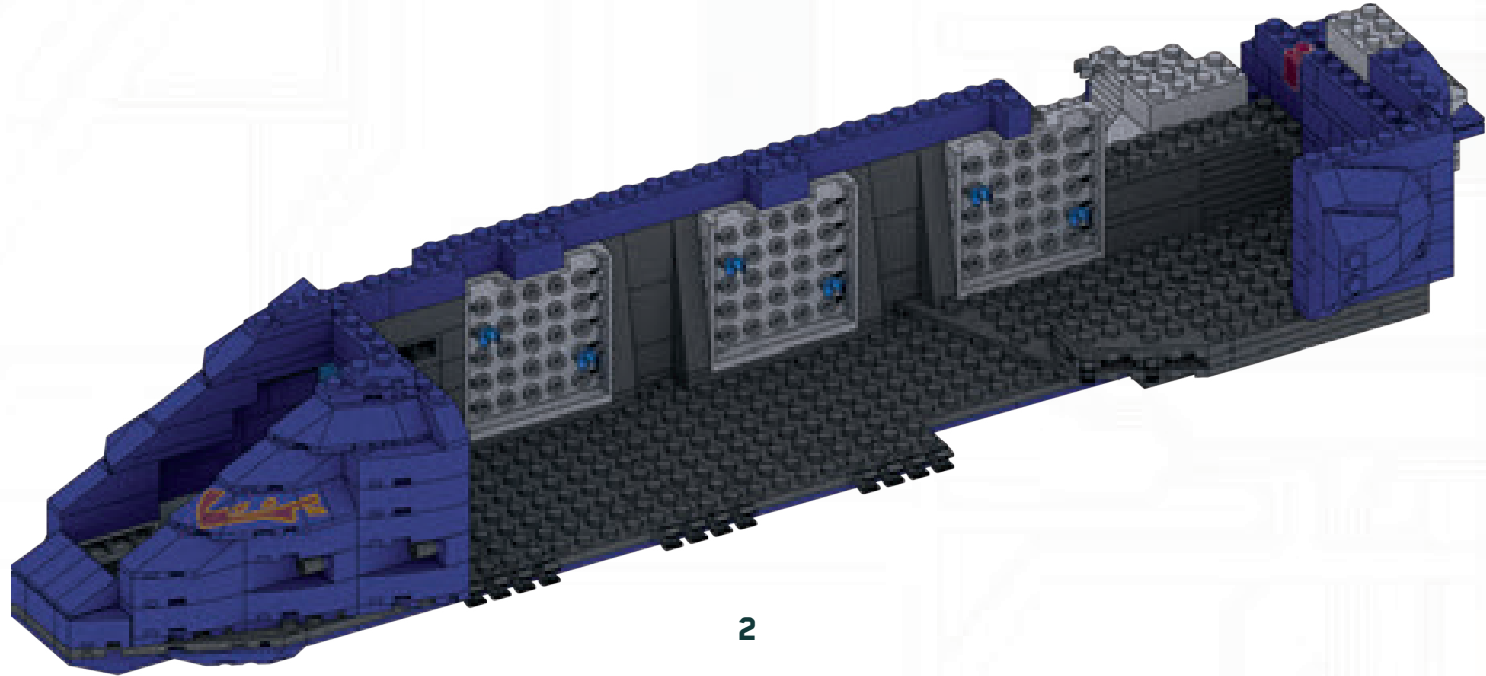

**SECTION • SECCIÓN • ABSCHNITT**  
**SECTIE • SEZIONE • SECÇÃO**



3

44-63

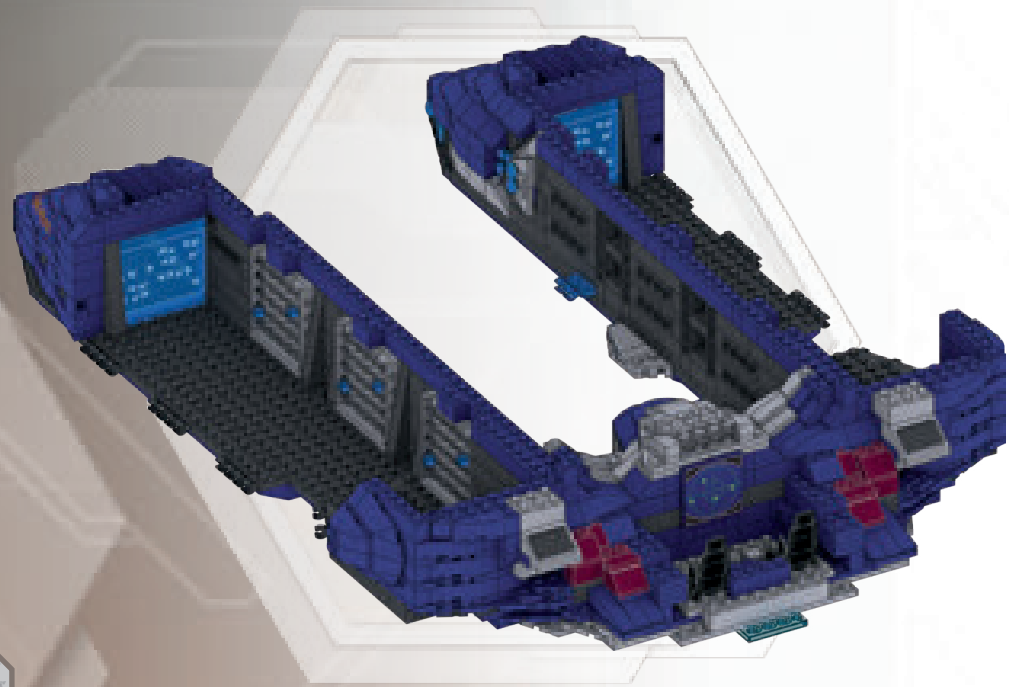

3

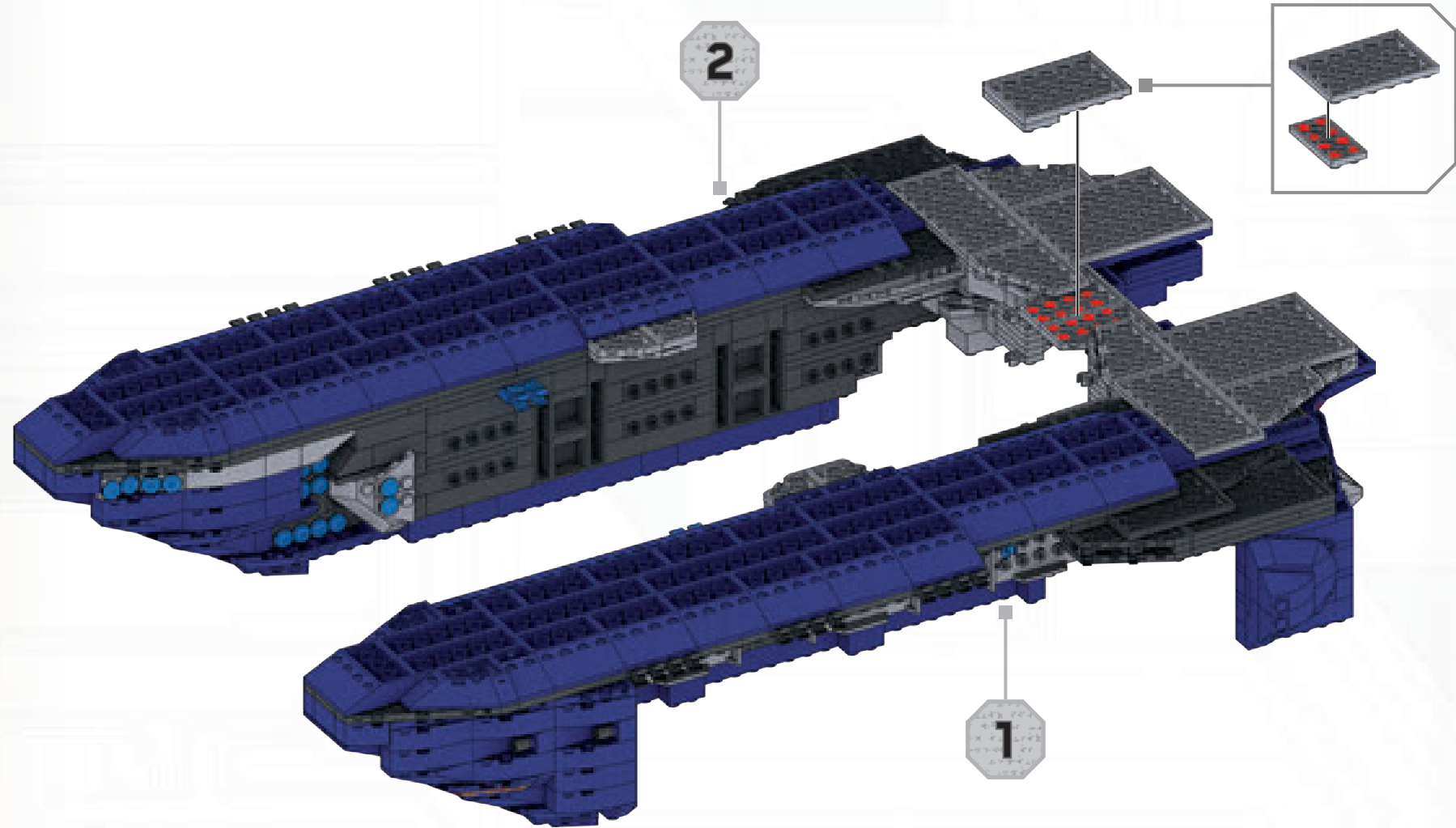
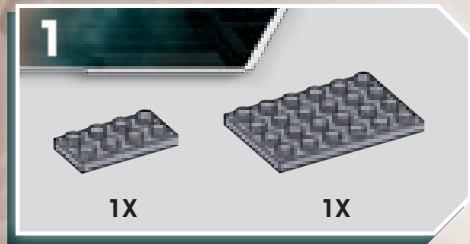

2



4X



1X

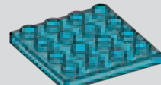

1X

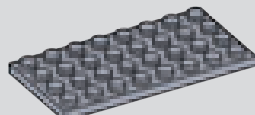

3X

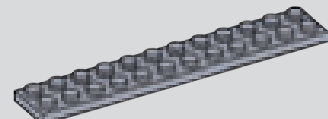

1X

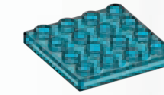
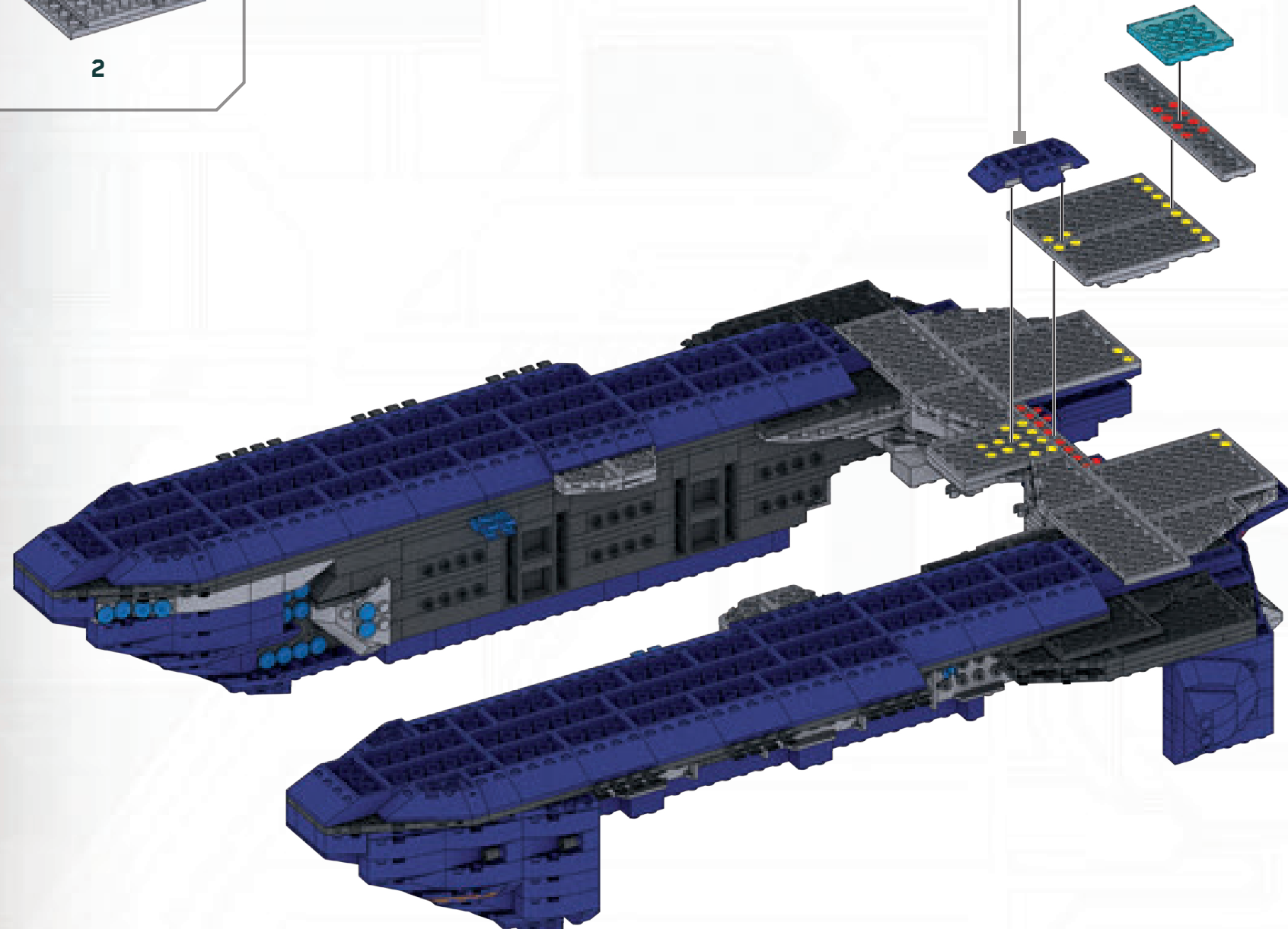
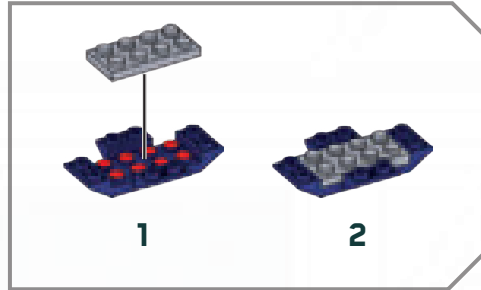
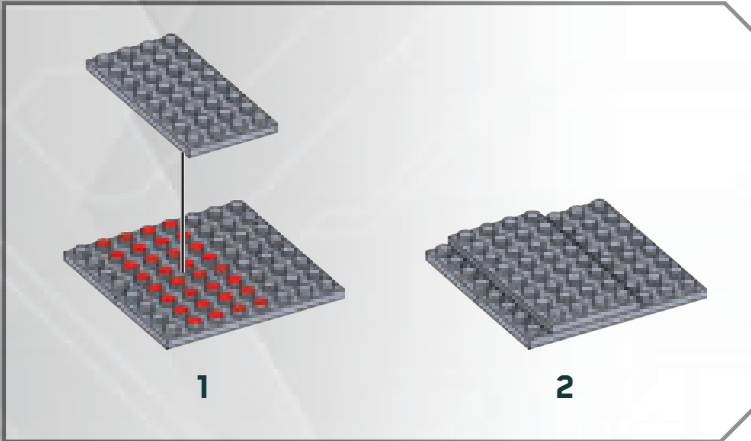

Place temporary piece  
 Placer la pièce temporaire  
 Colocar la pieza provisional  
 Colocar a peça temporária  
 Posizionare il pezzo provvisorio  
 Das vorübergehend benötigte Teil platzieren  
 Umieść tymczasowy element  
 Plaats tijdelijk deel  
 Поместите временную деталь  
 Placer midlertidigt stykke.  
 Placera temporär del  
 Placer midlertidig del  
 Aseta väliaikainen osa  
 Τοποθετήστε το προσωρινό κομμάτι  
 Geçici parçayı yerleştirin  
 放置临时件  
 暂定ピースを配置してください  
 ضع القطعة المؤقتة

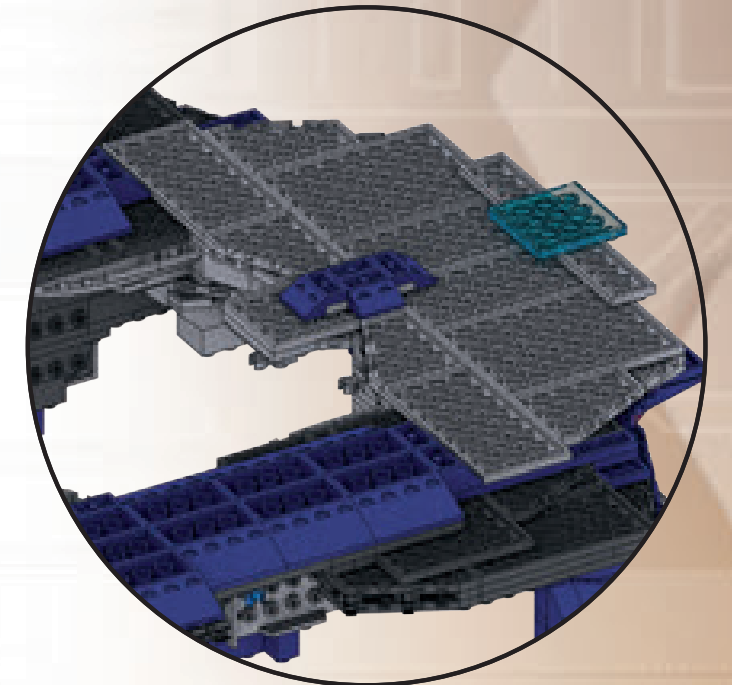

3

3



1X



1X



1X

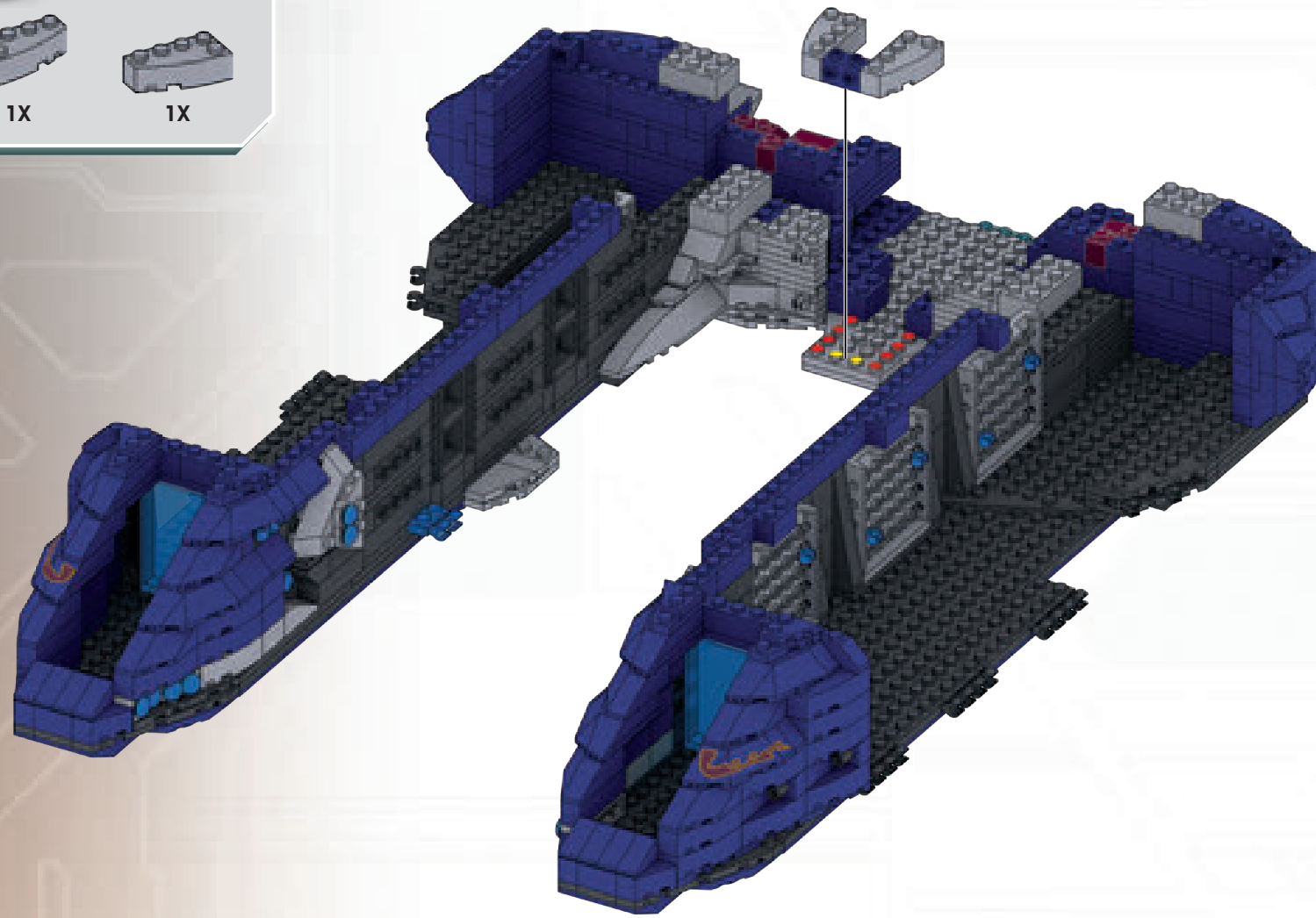

1

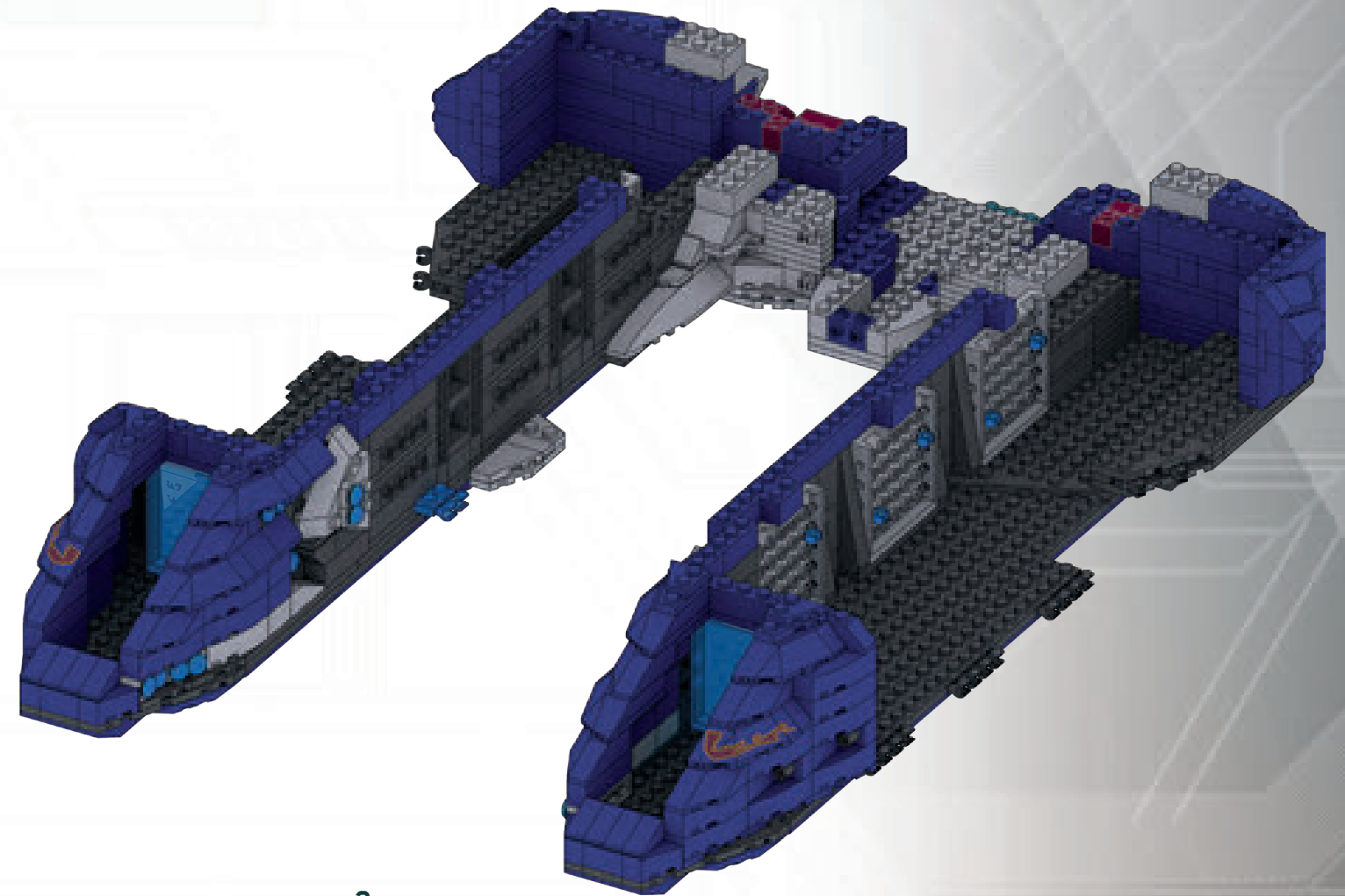

2

3



**4**

1X      1X      1X

**5**

2X      4X      2X

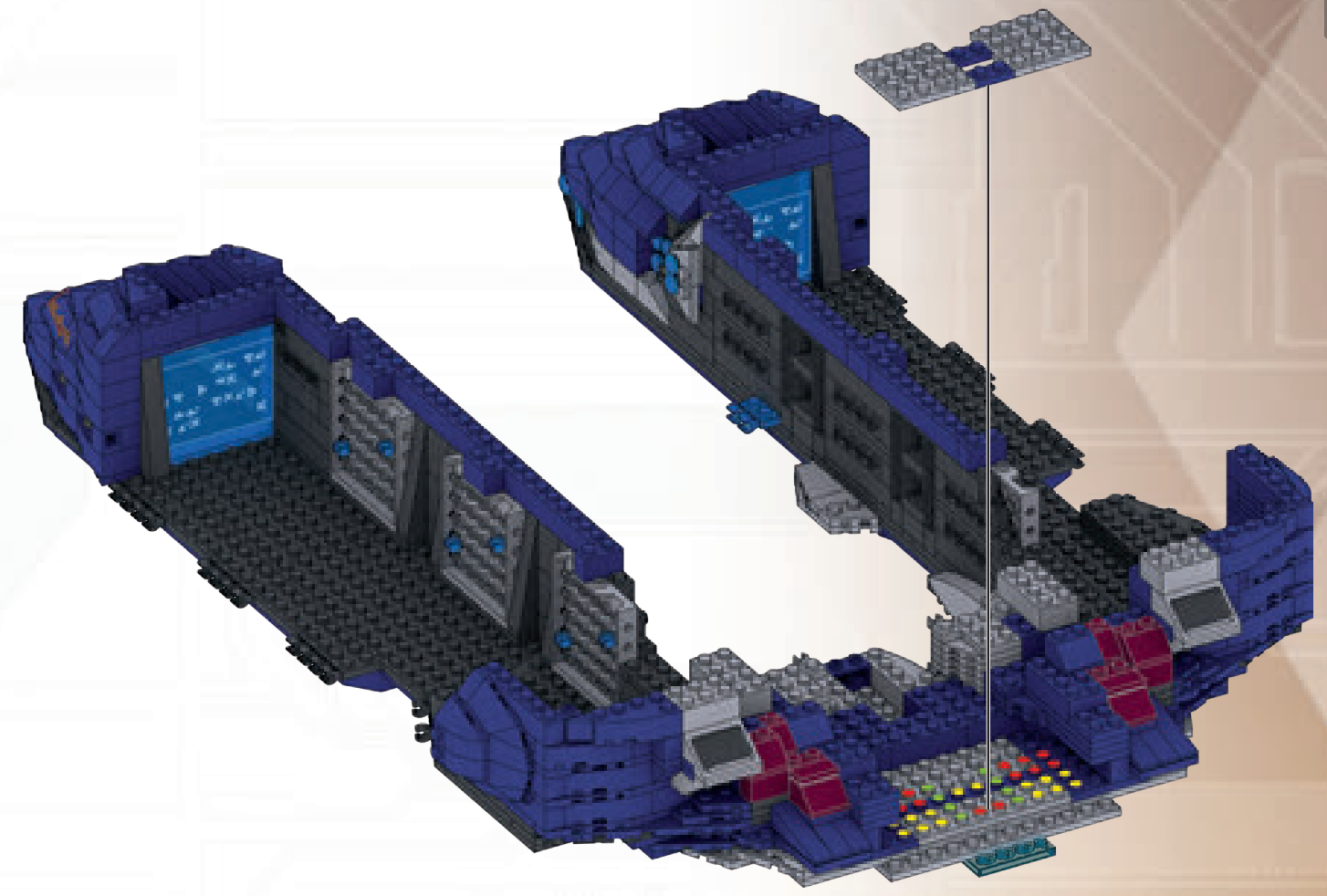
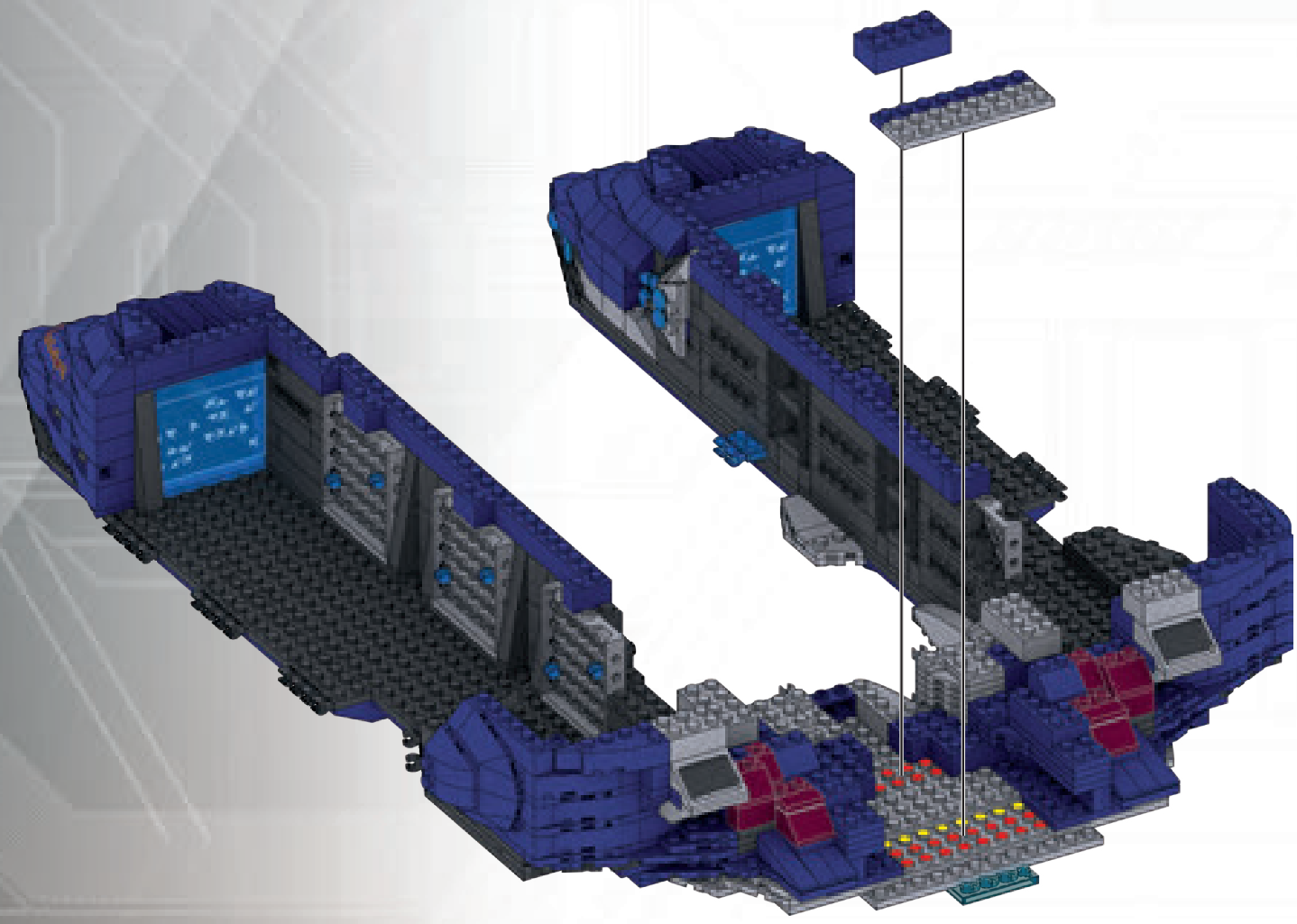

3

6



2X



1X

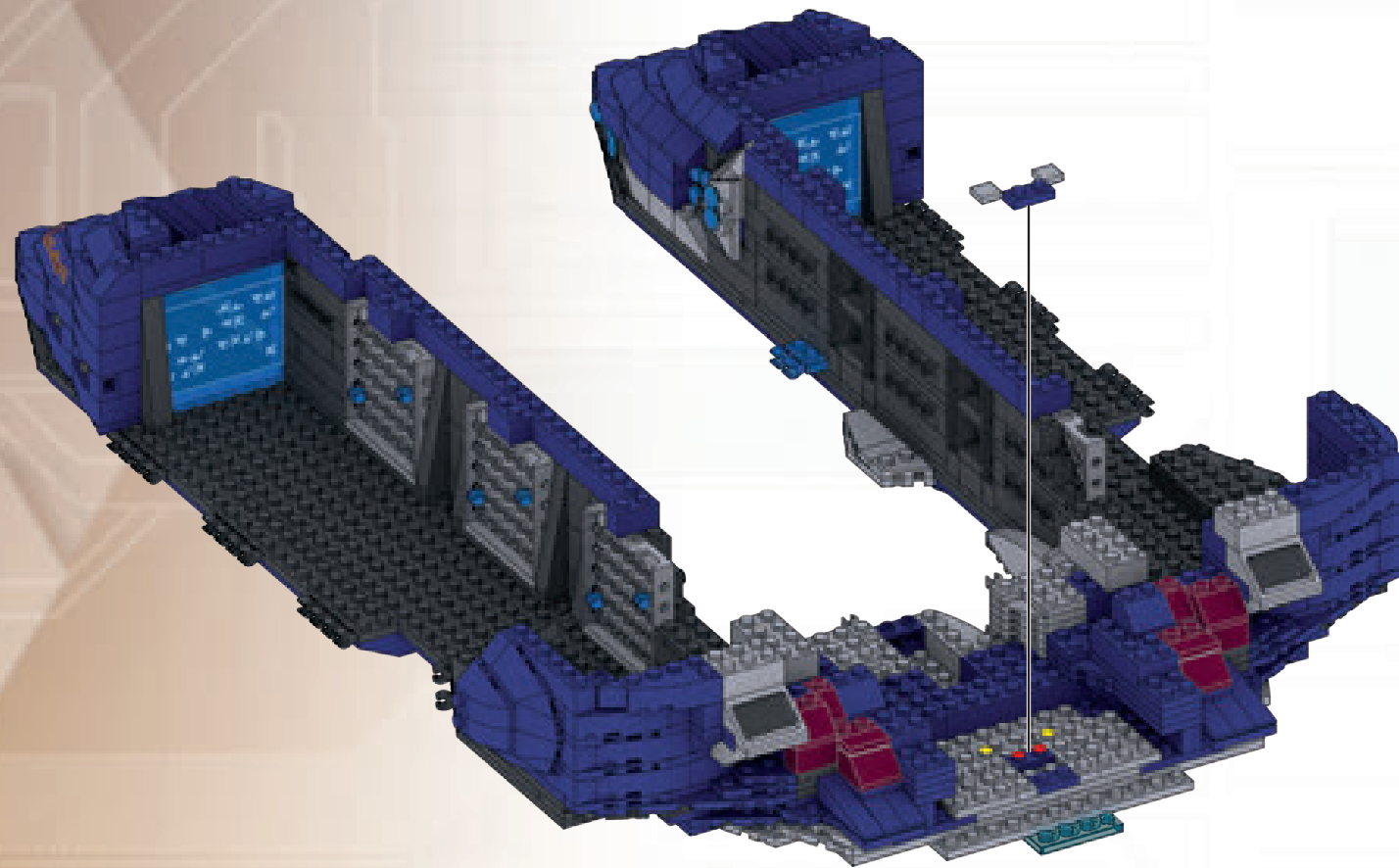

7



2X



2X



1X



1X



1X



1X

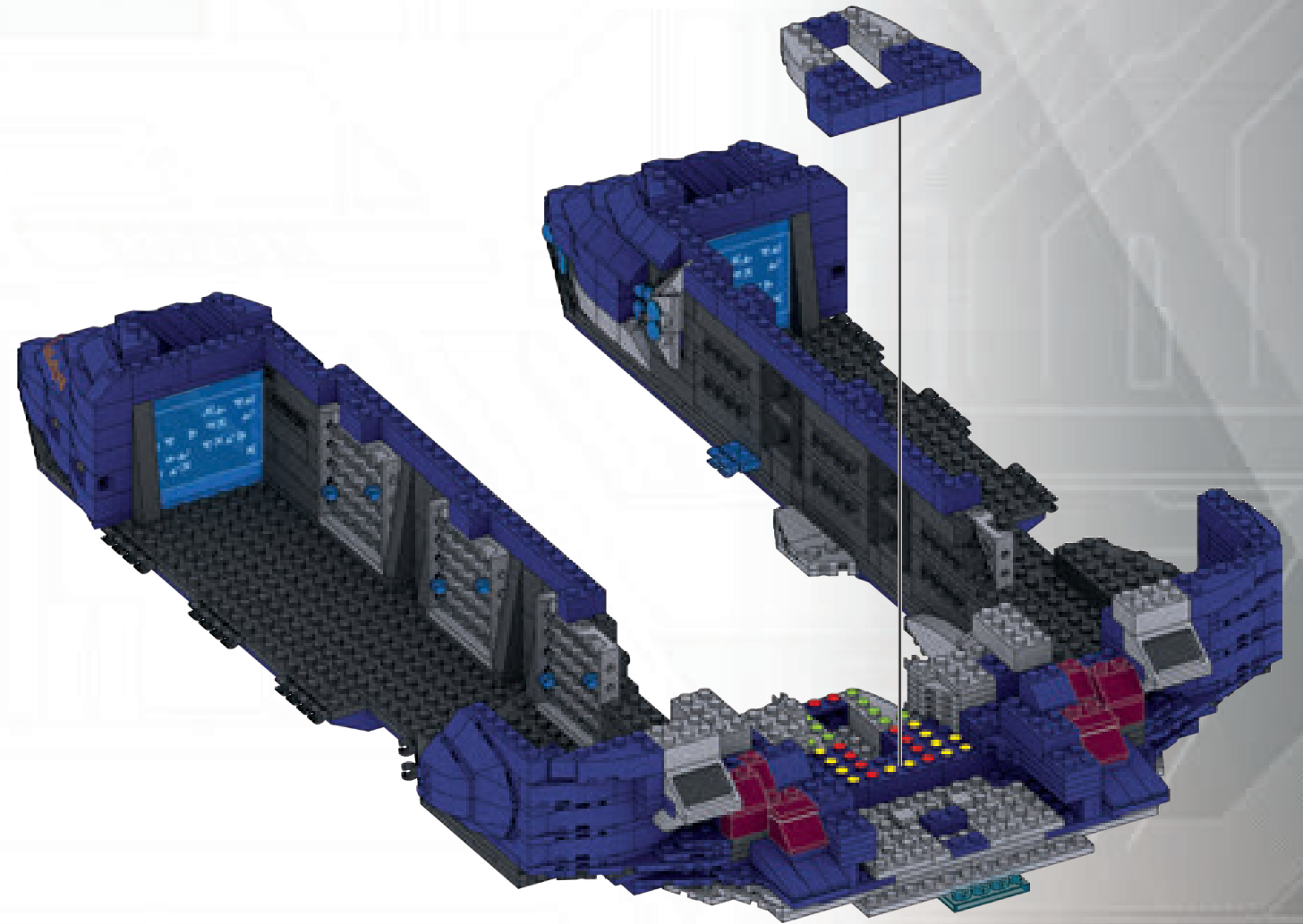

3

8



9

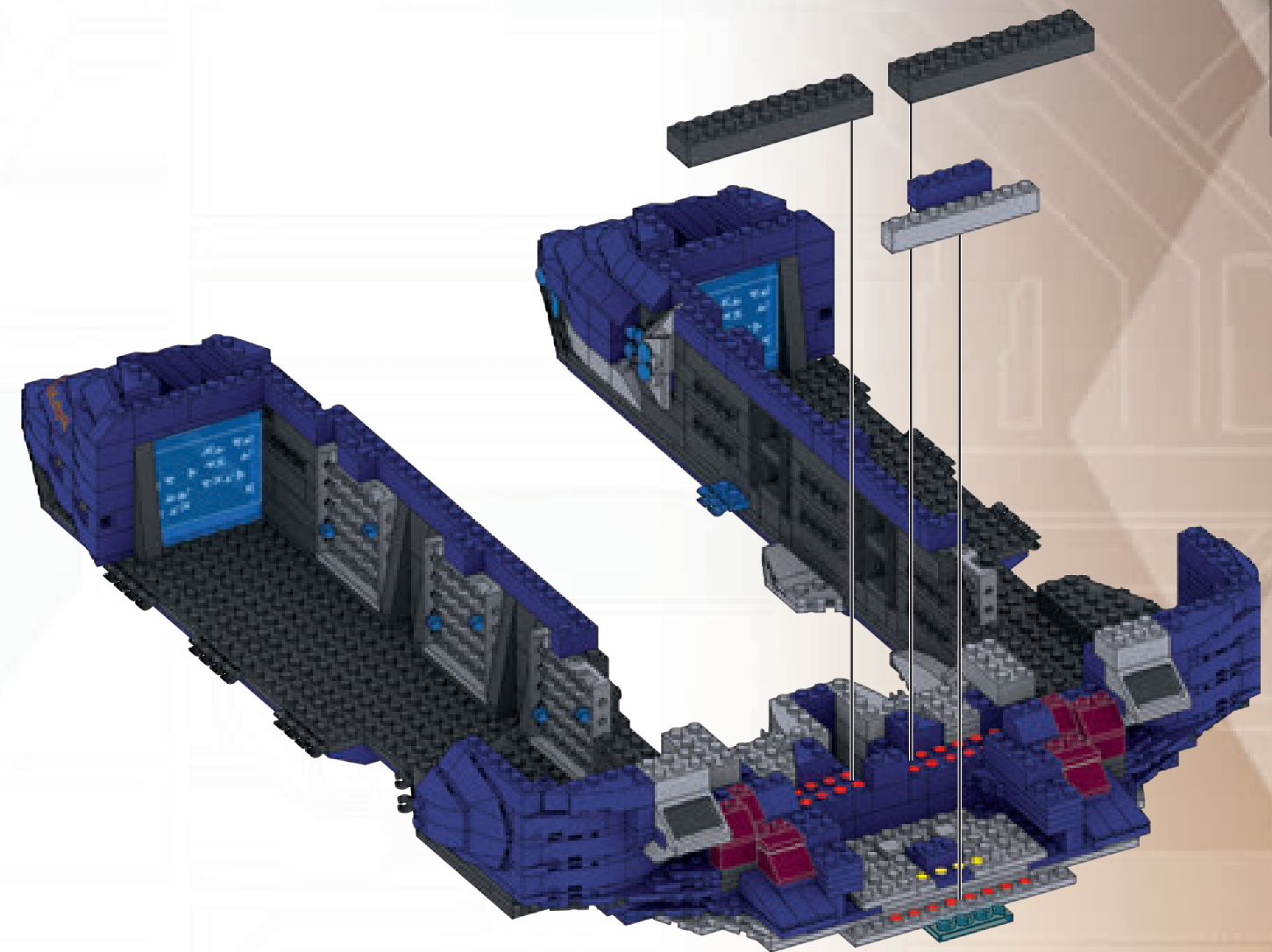
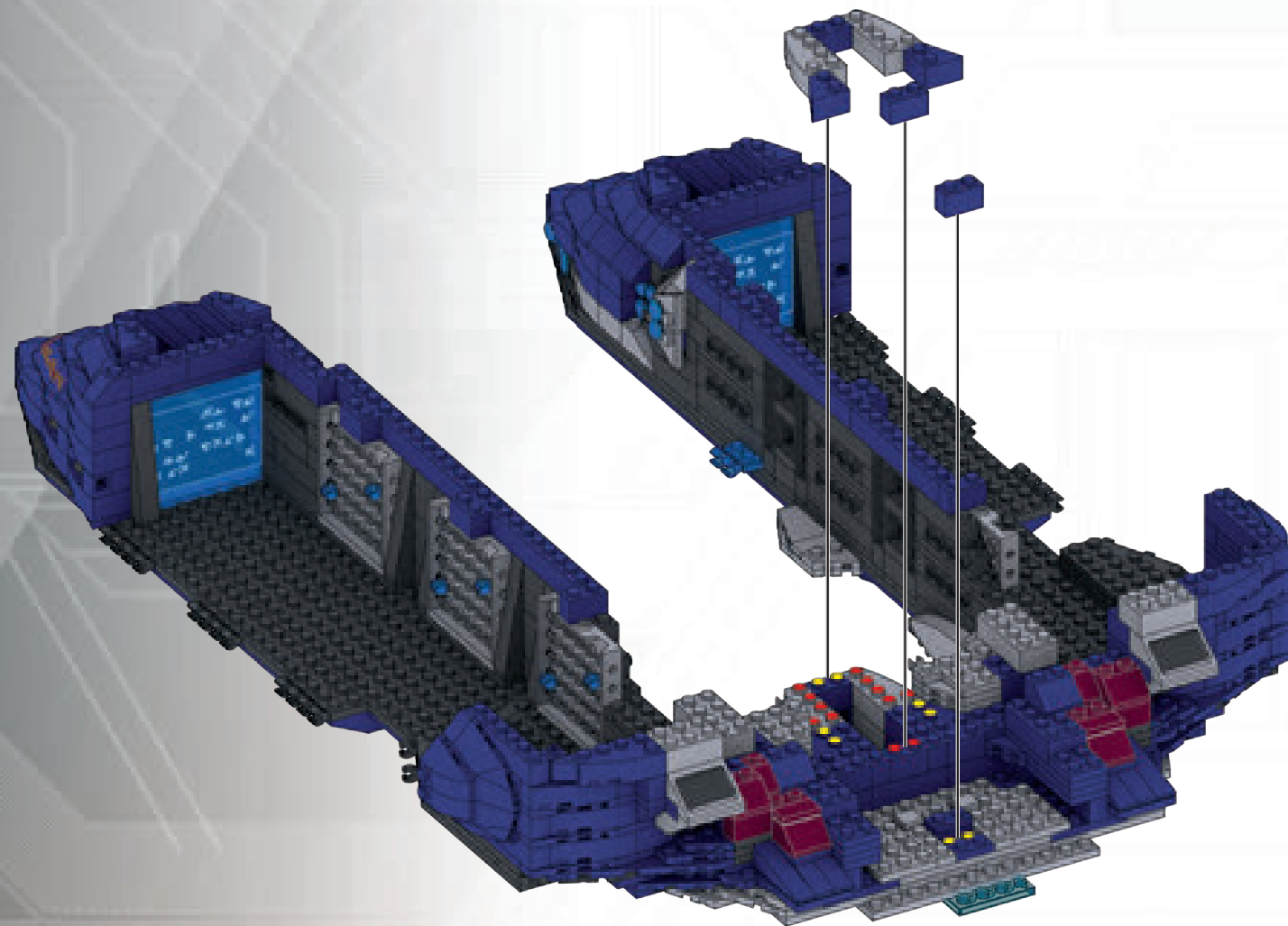
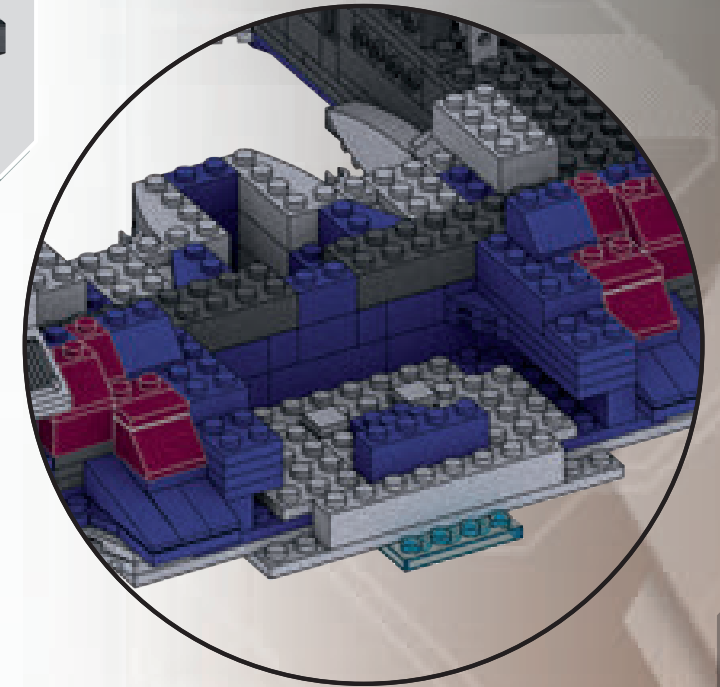
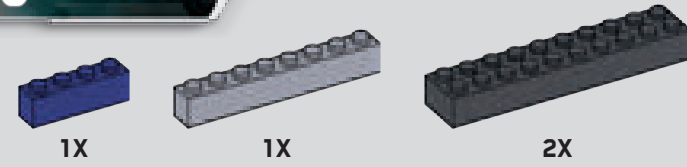

3

10

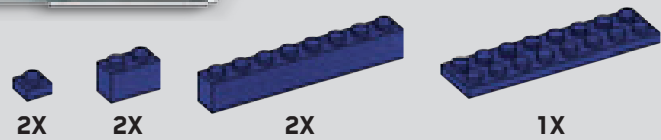

11



3

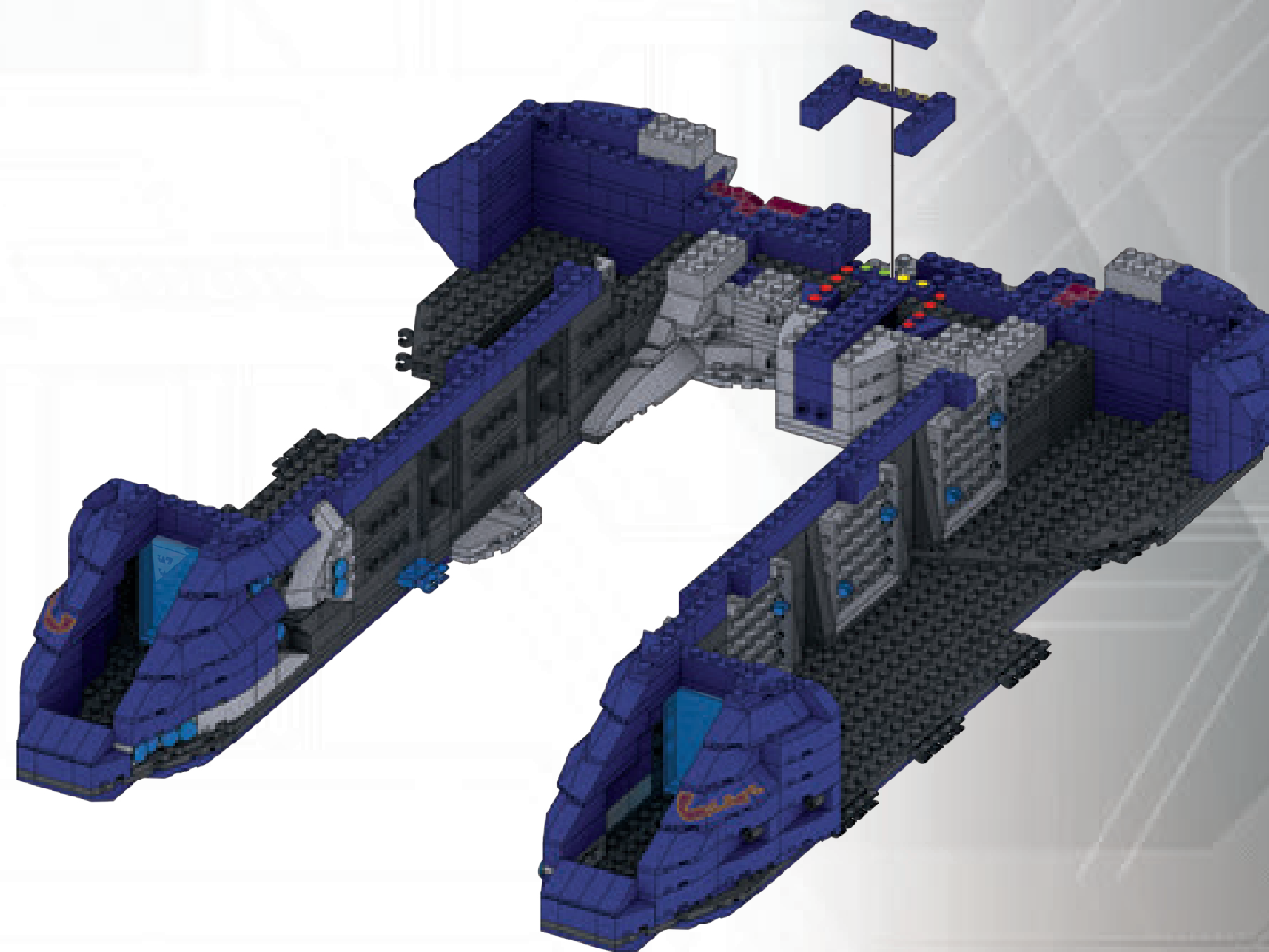
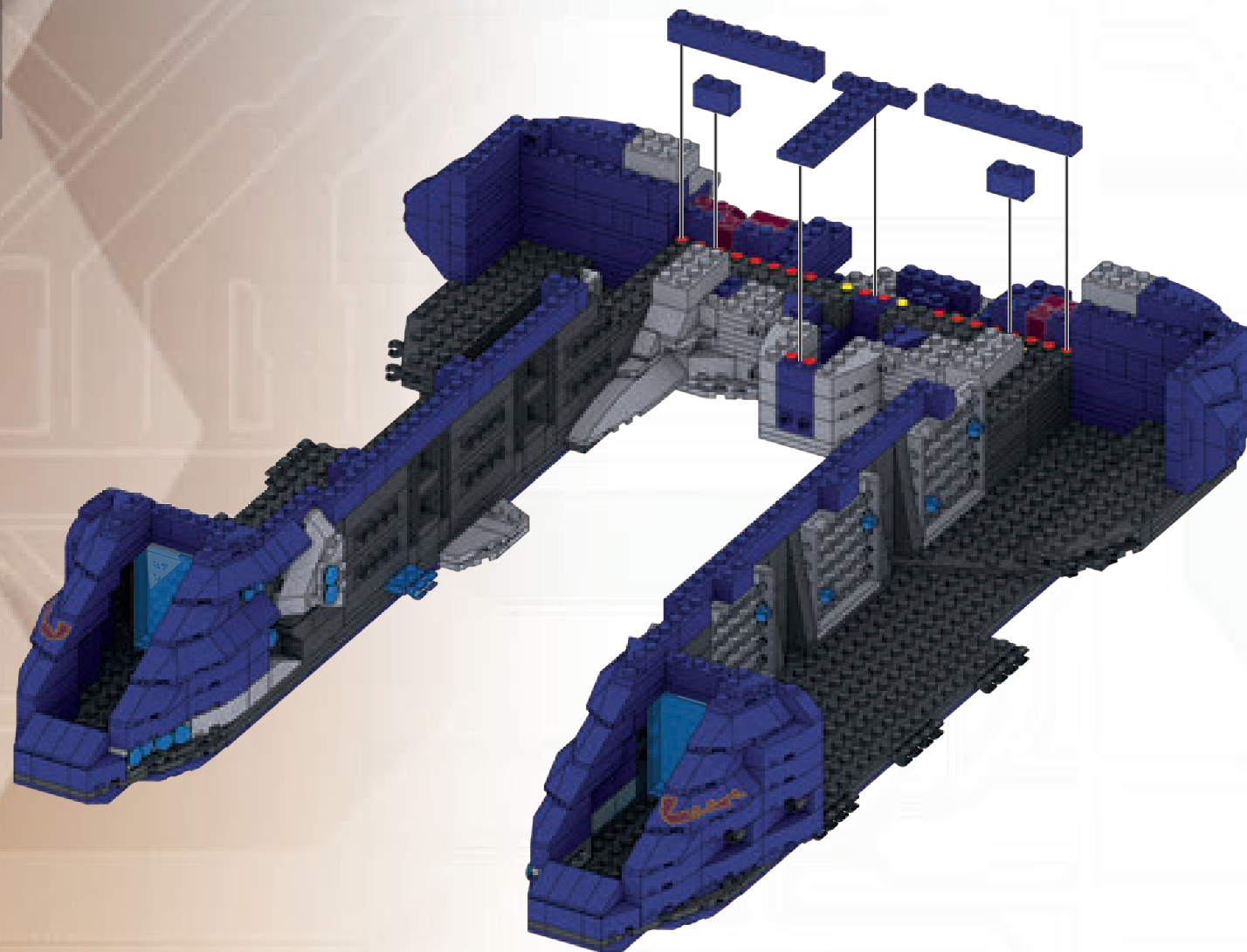

**12**

1X 1X 4X

**13**

2X 1X 1X 1X

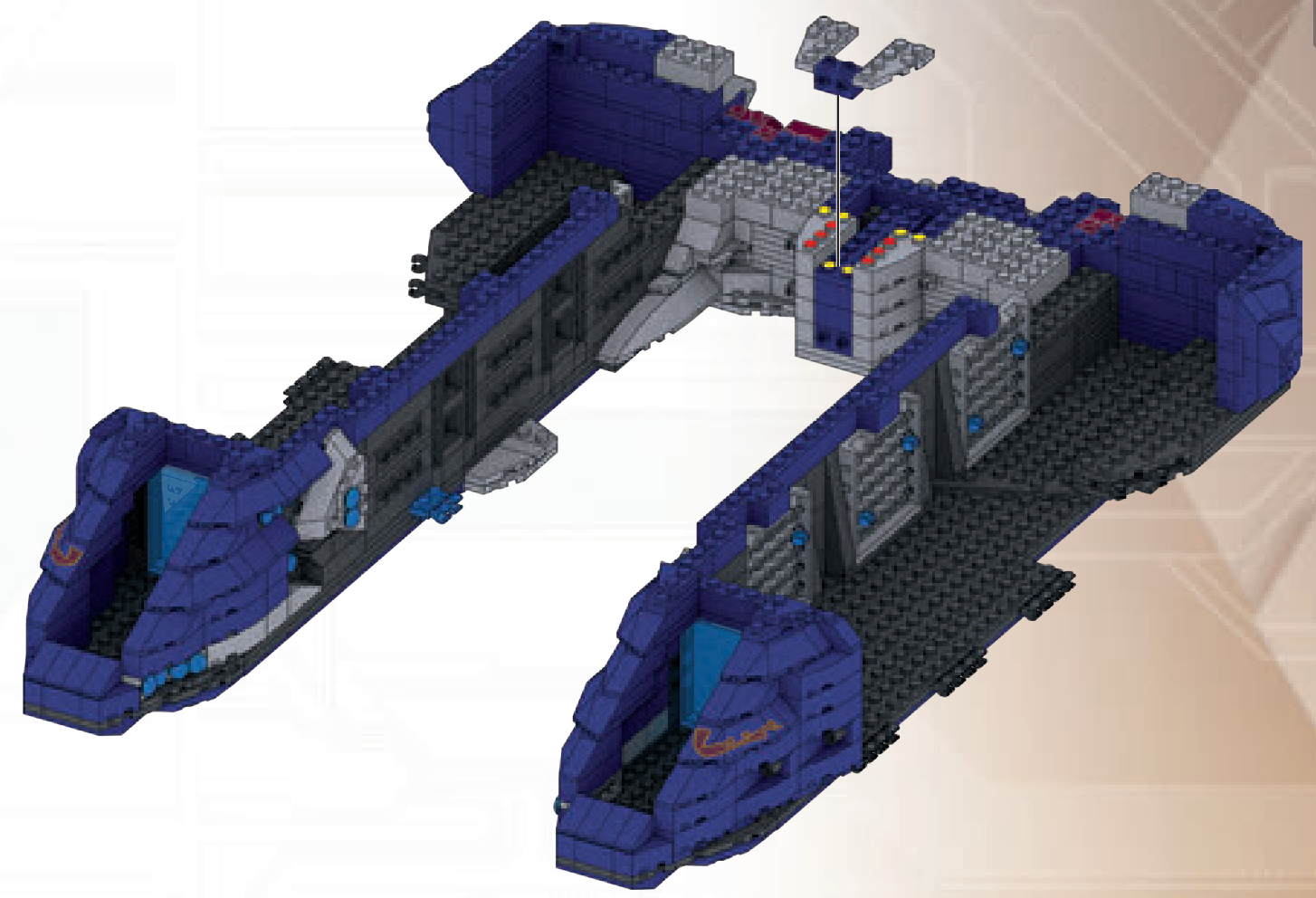
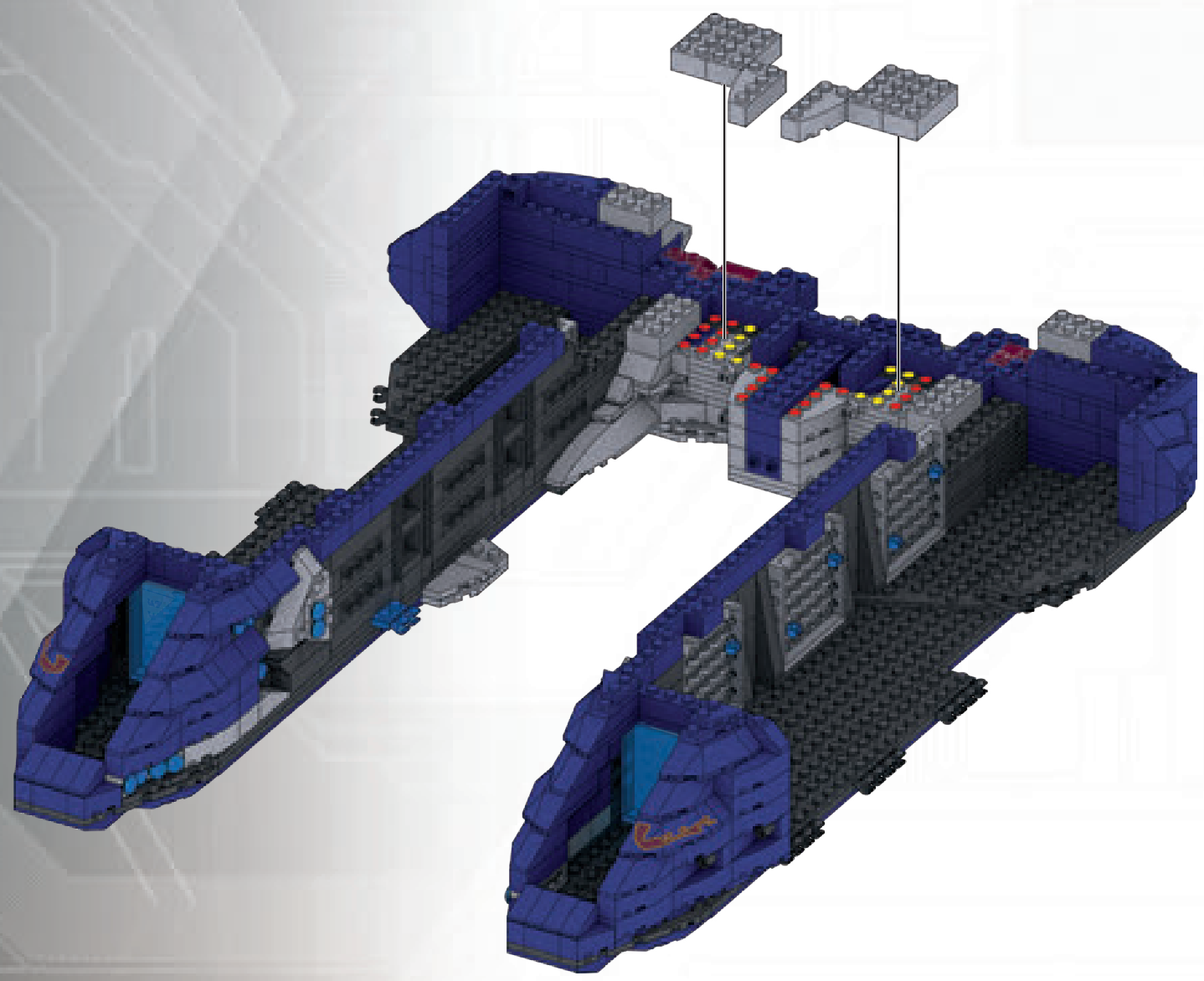

3

14

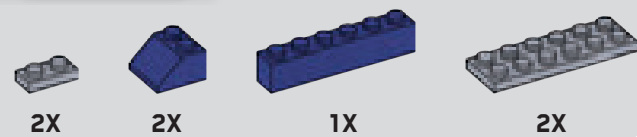

15

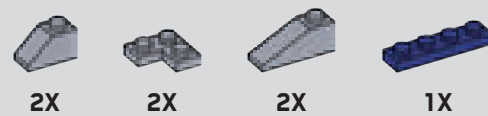

3

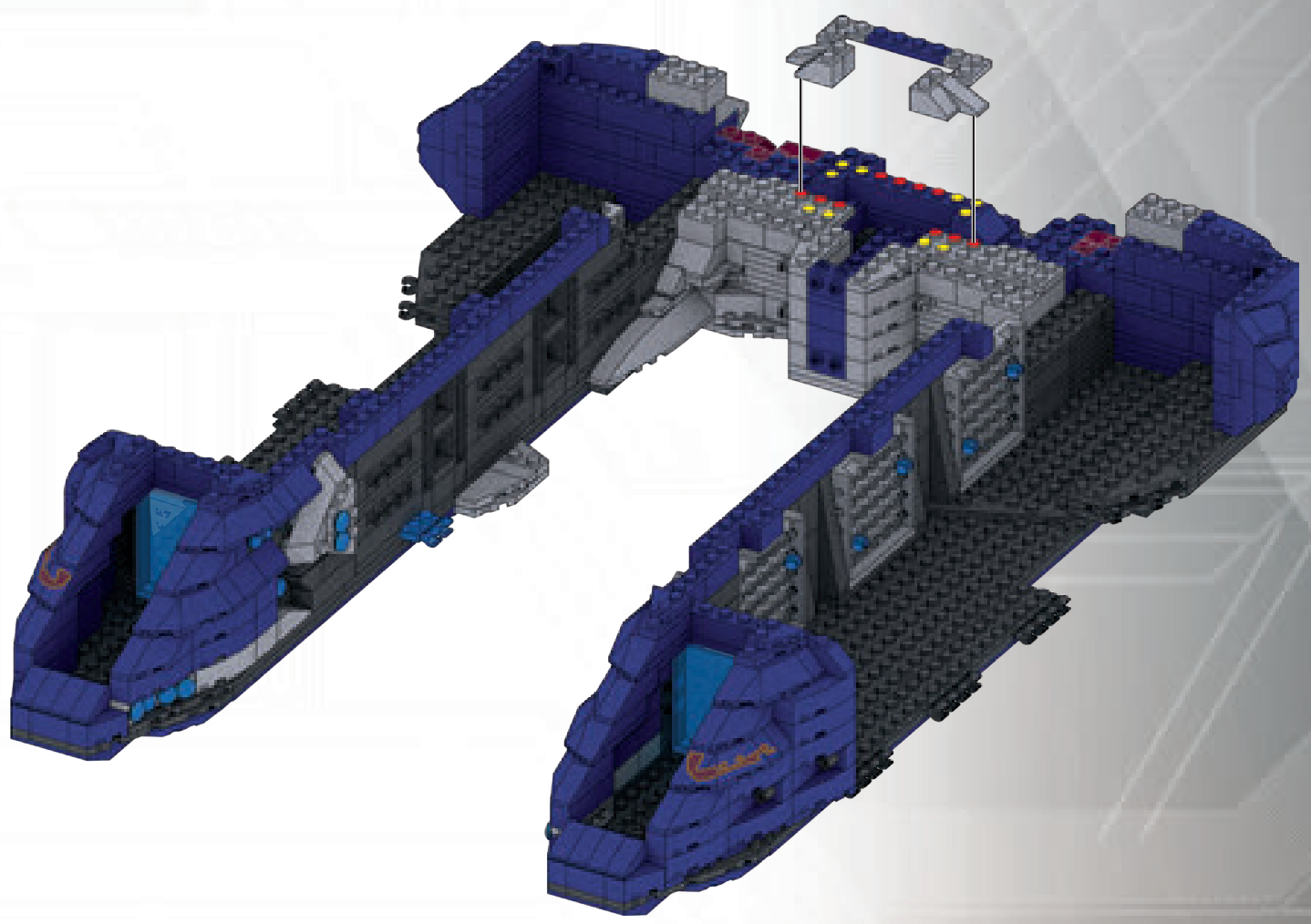
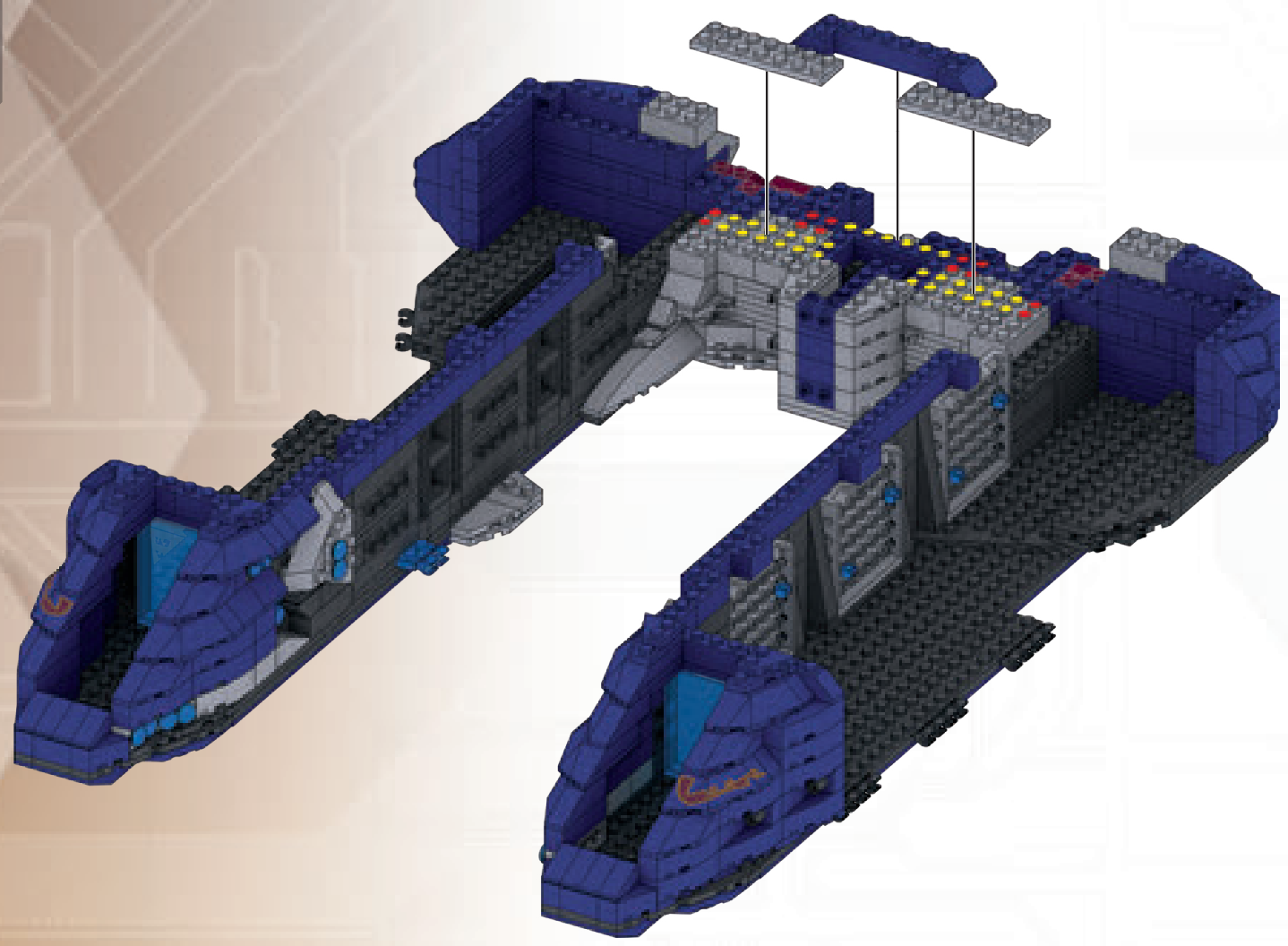

16

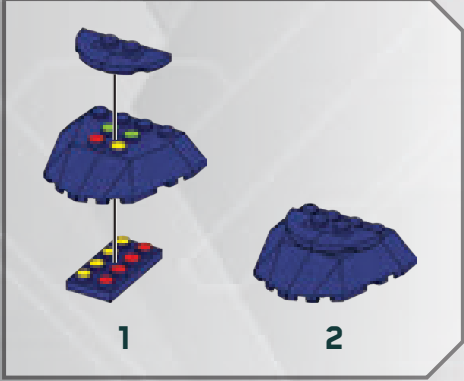
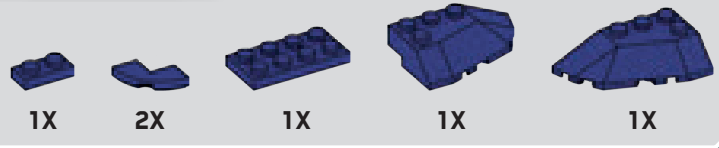

17

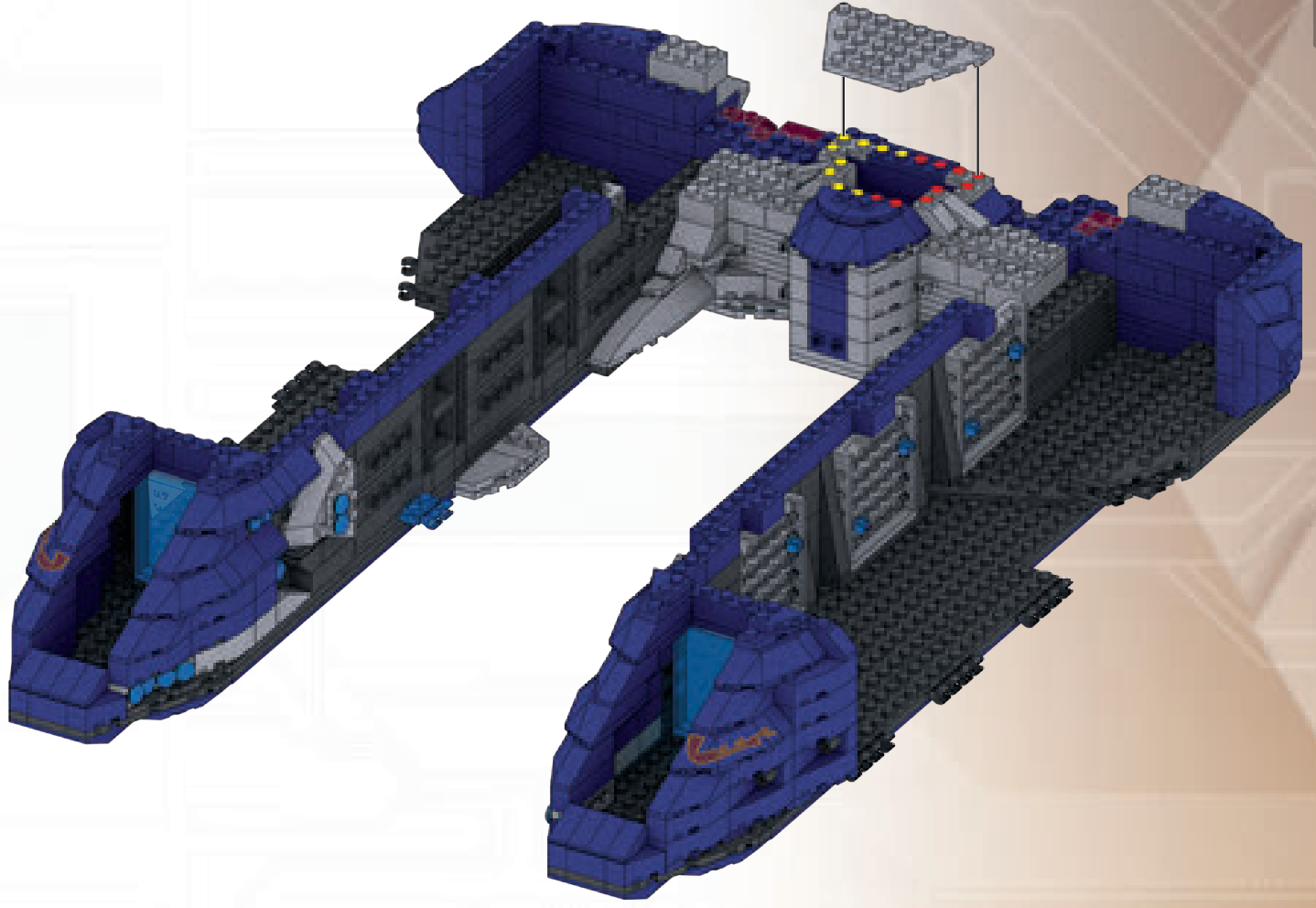
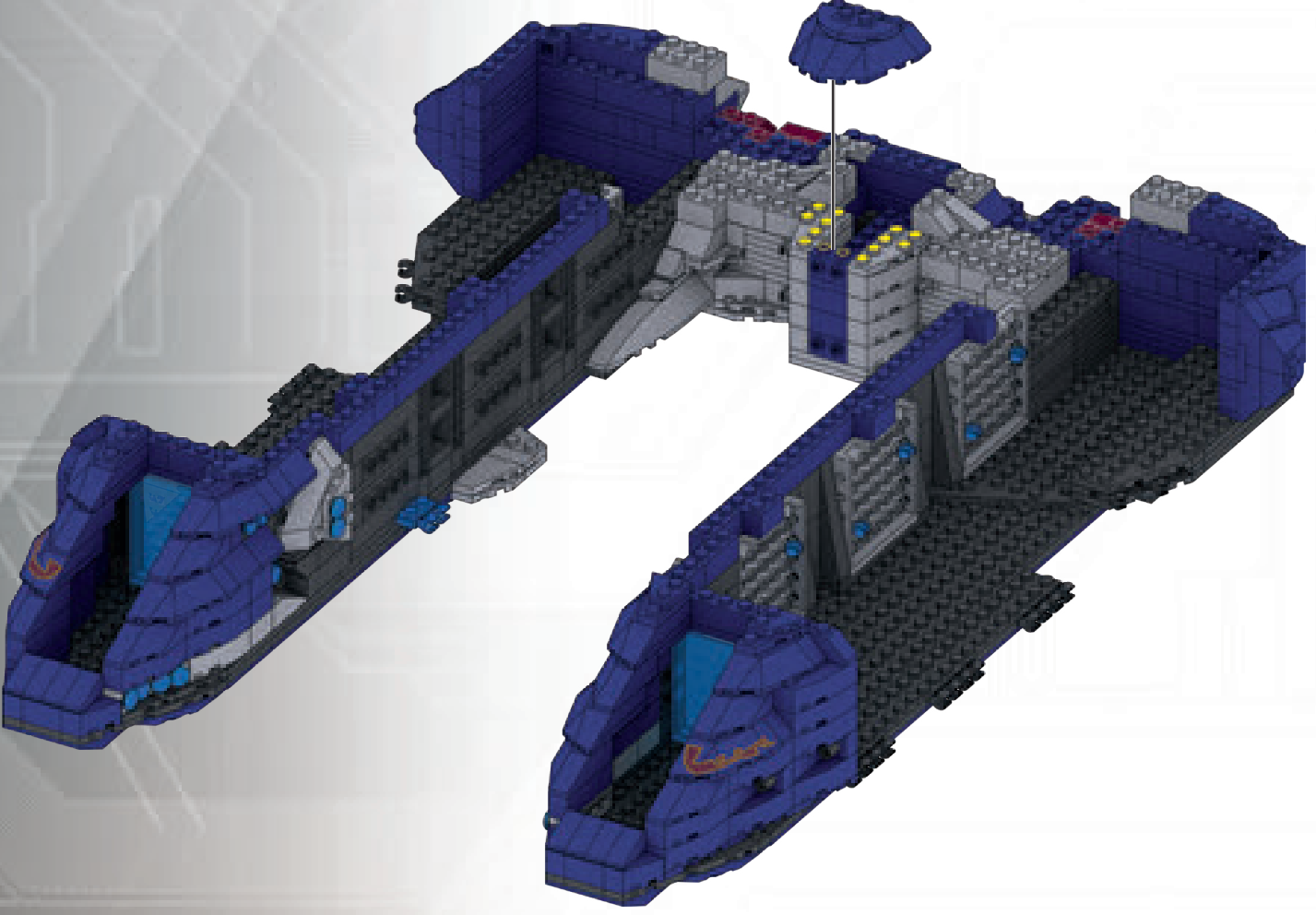
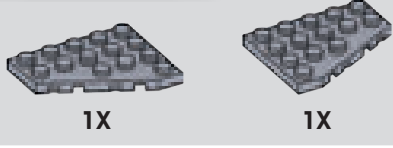

3

18



19



3

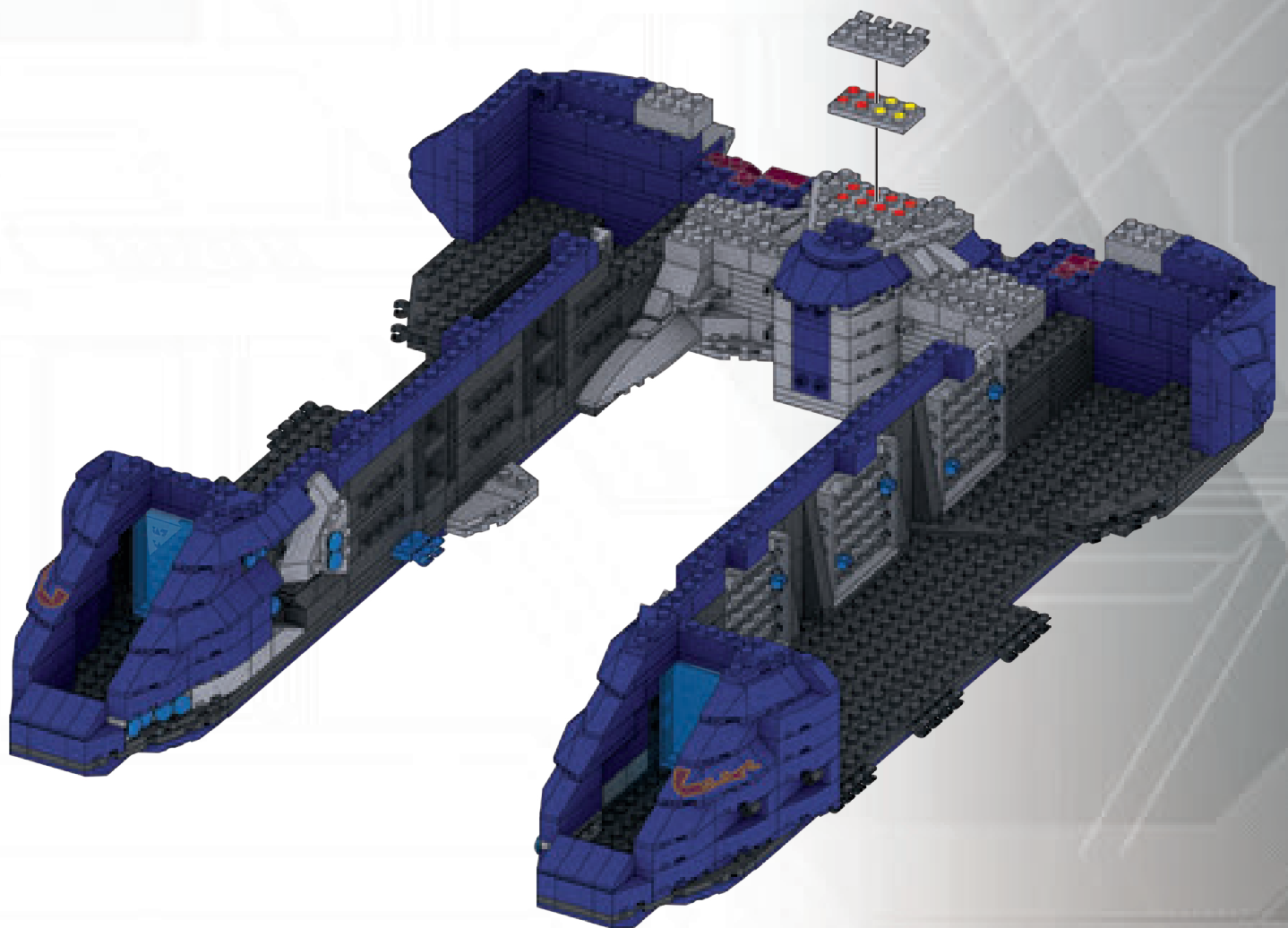



**20**

2X   2X   1X

**21**

2X

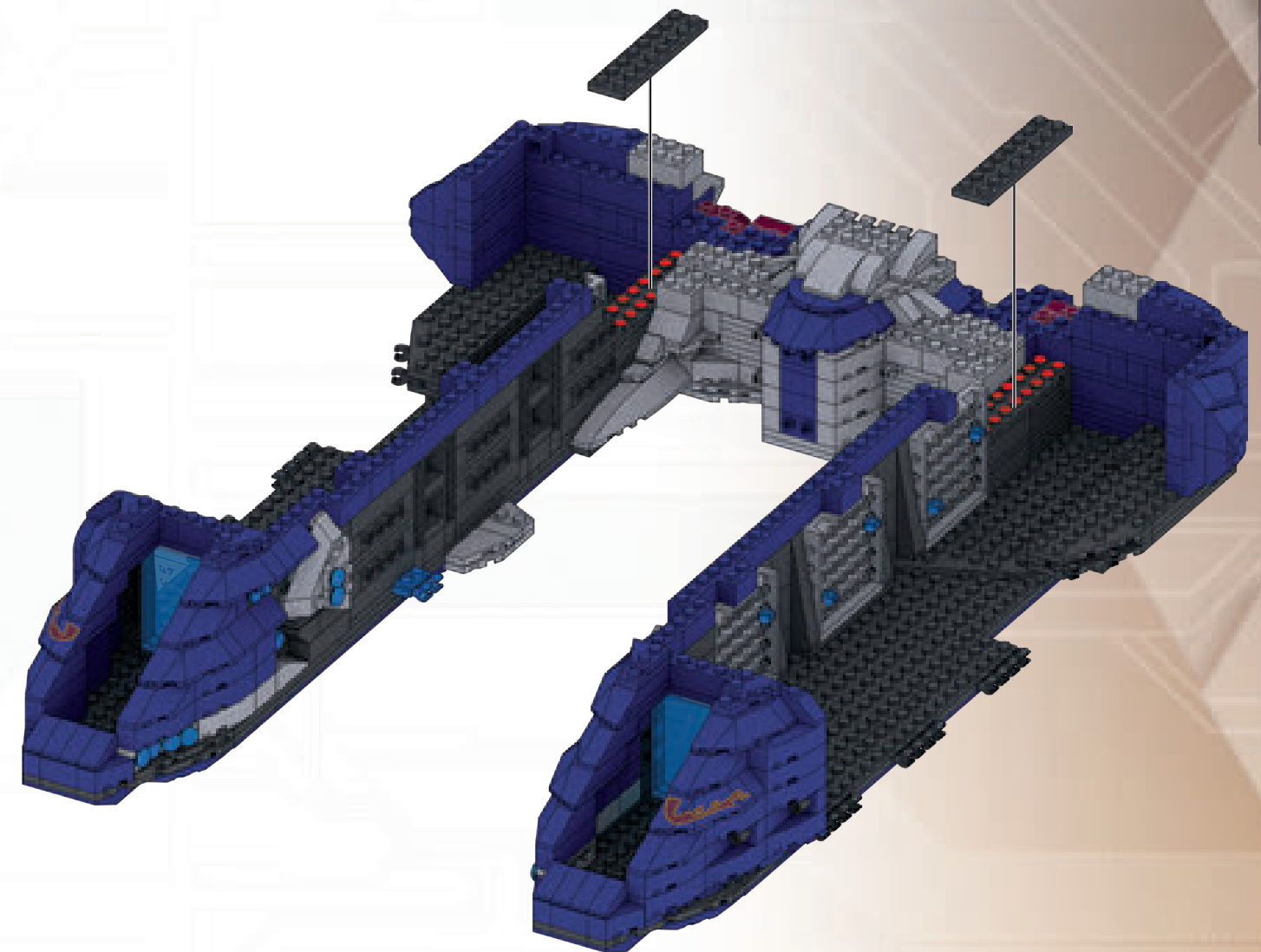
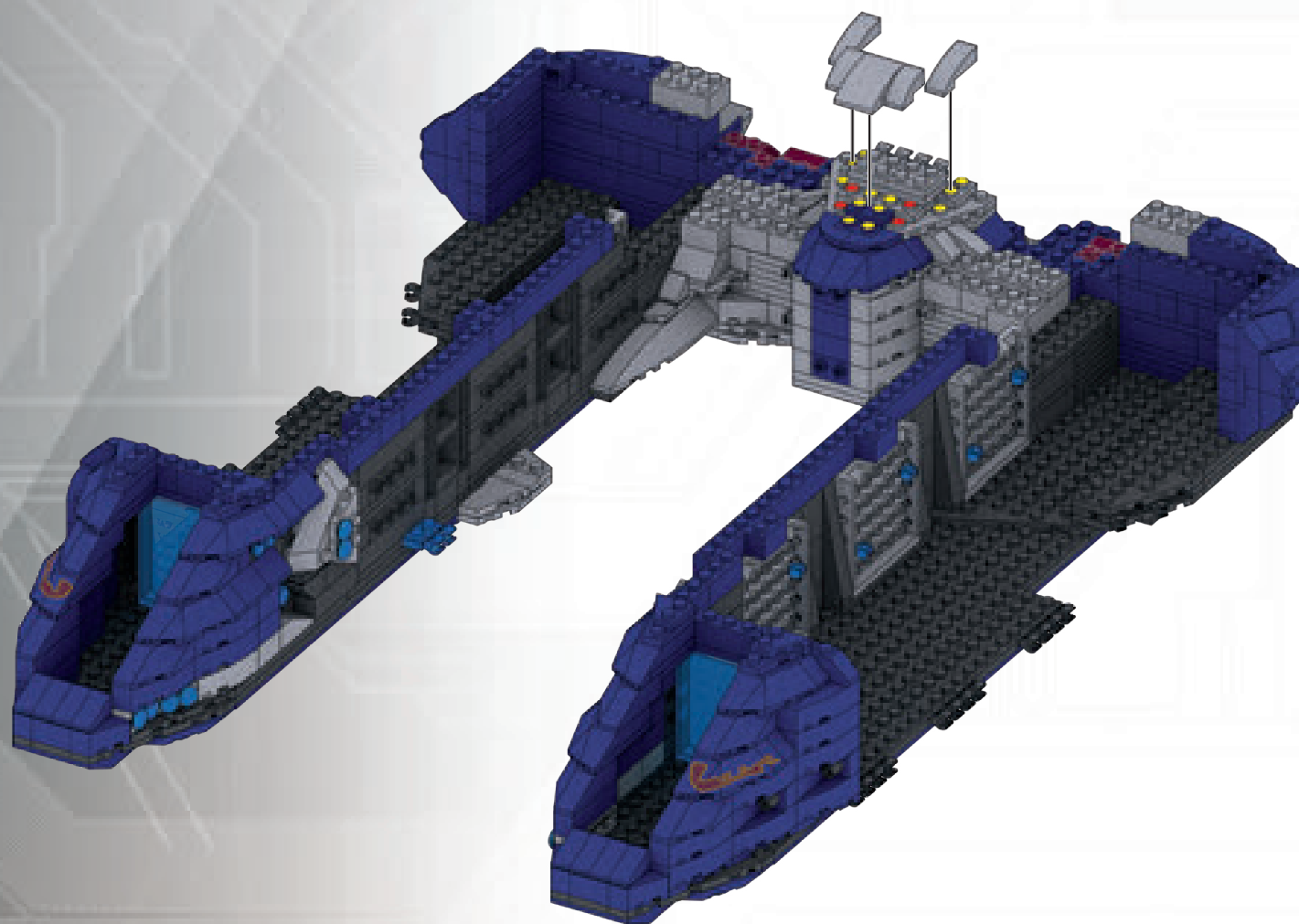

3

22



2X

4X

23



2X

2X

2X

1X

1X

3

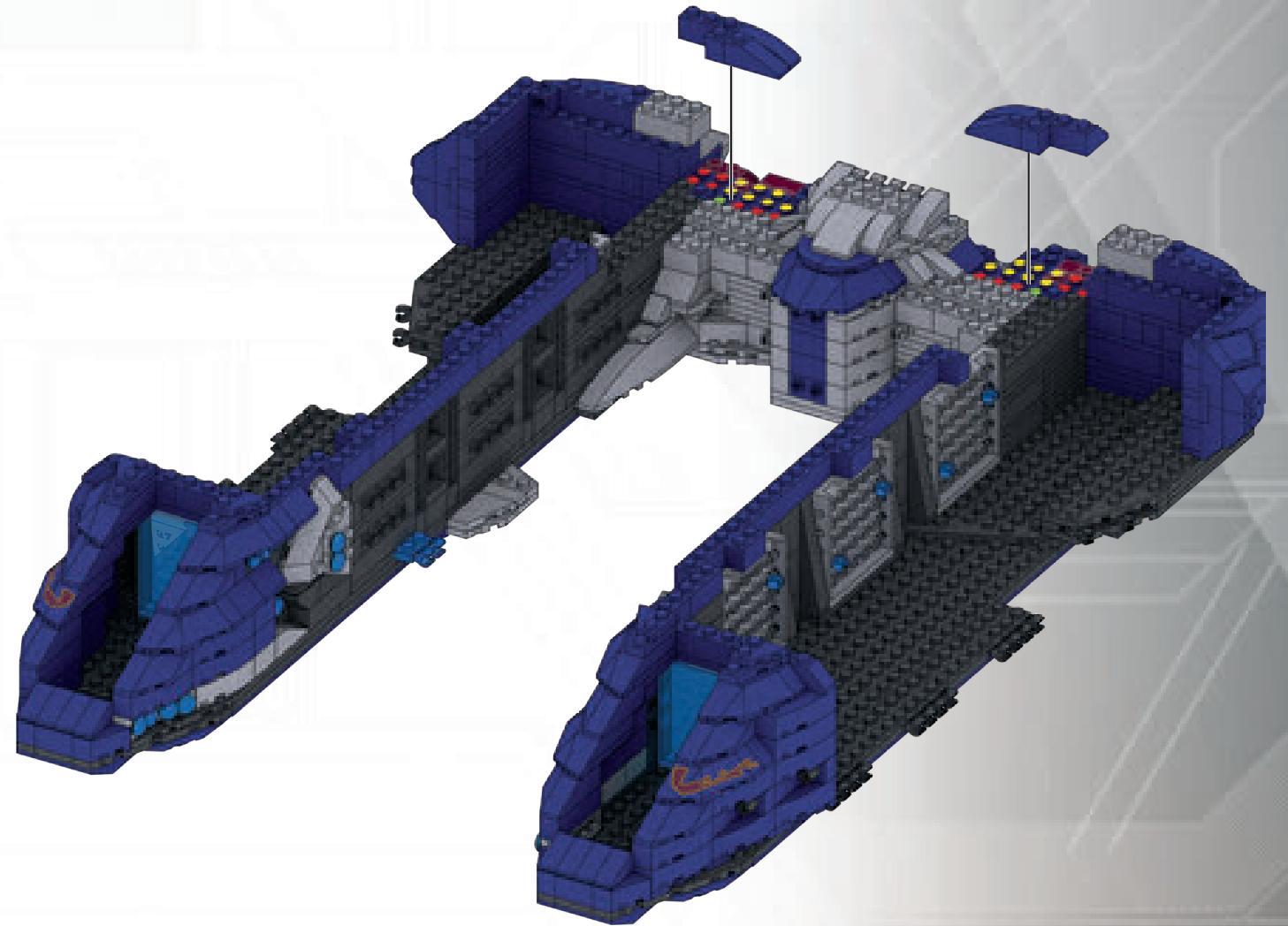
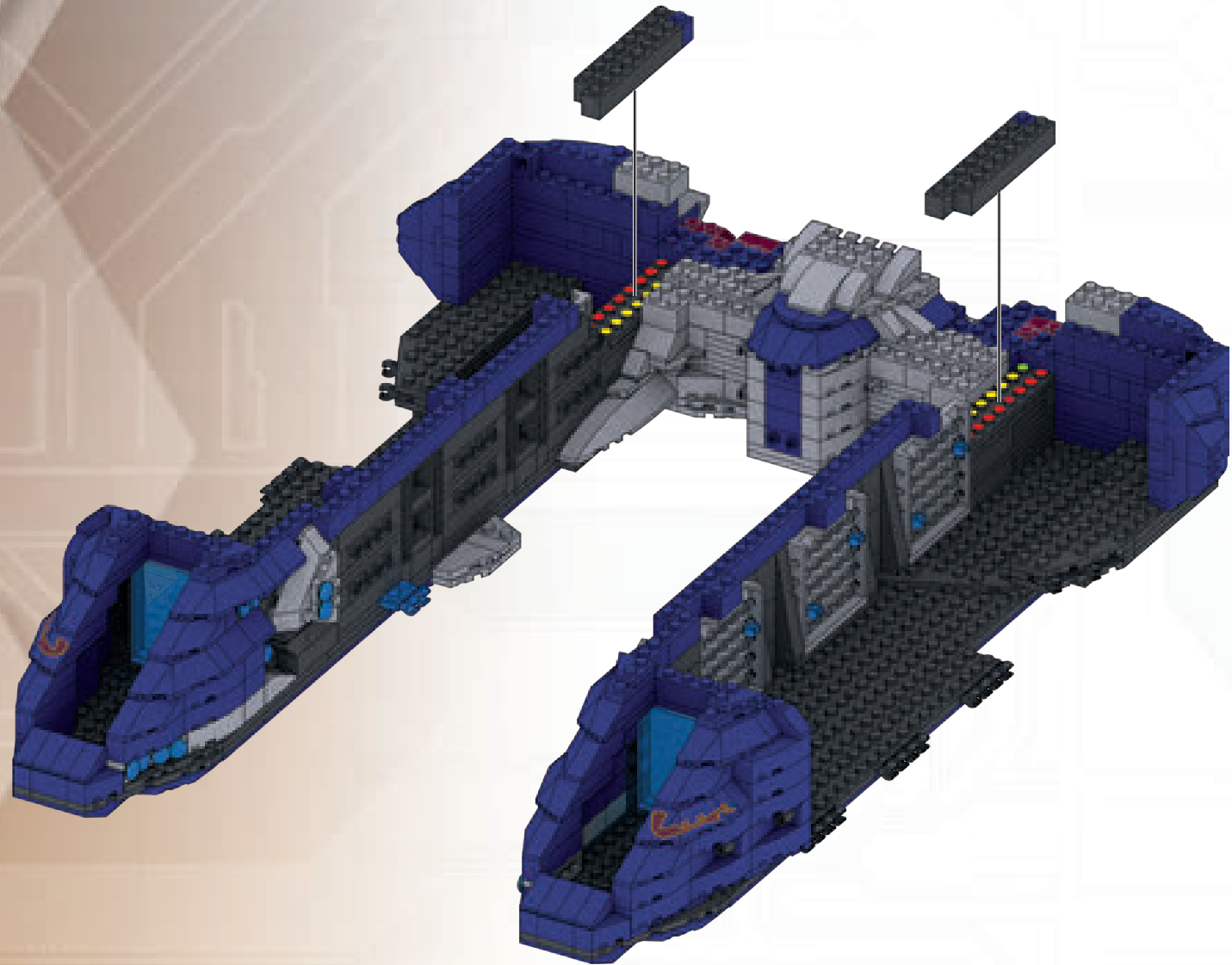

24

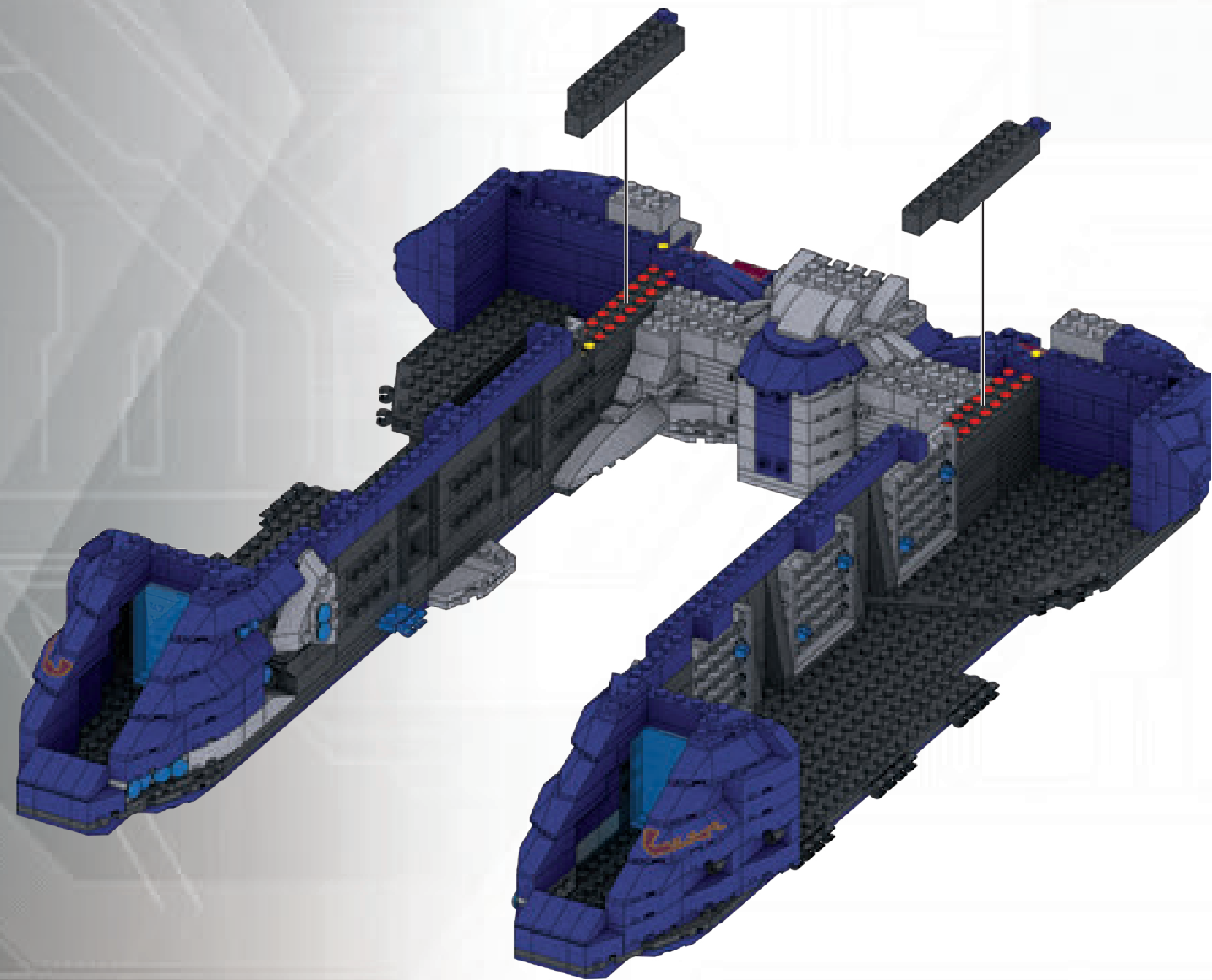

25

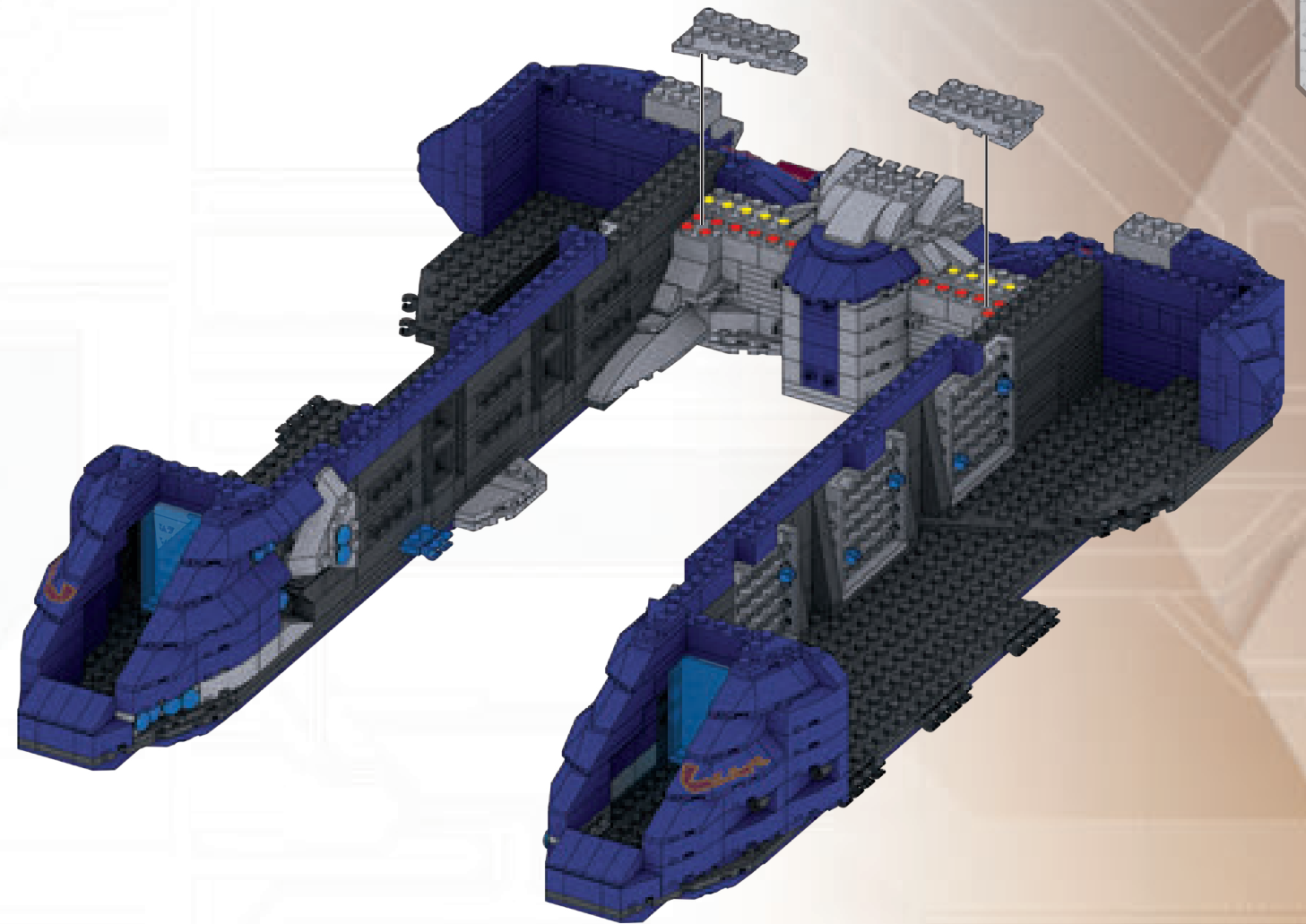
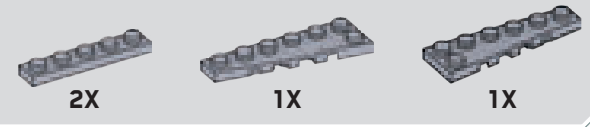

3

26



4X



4X



1X



1X

27



2X

3

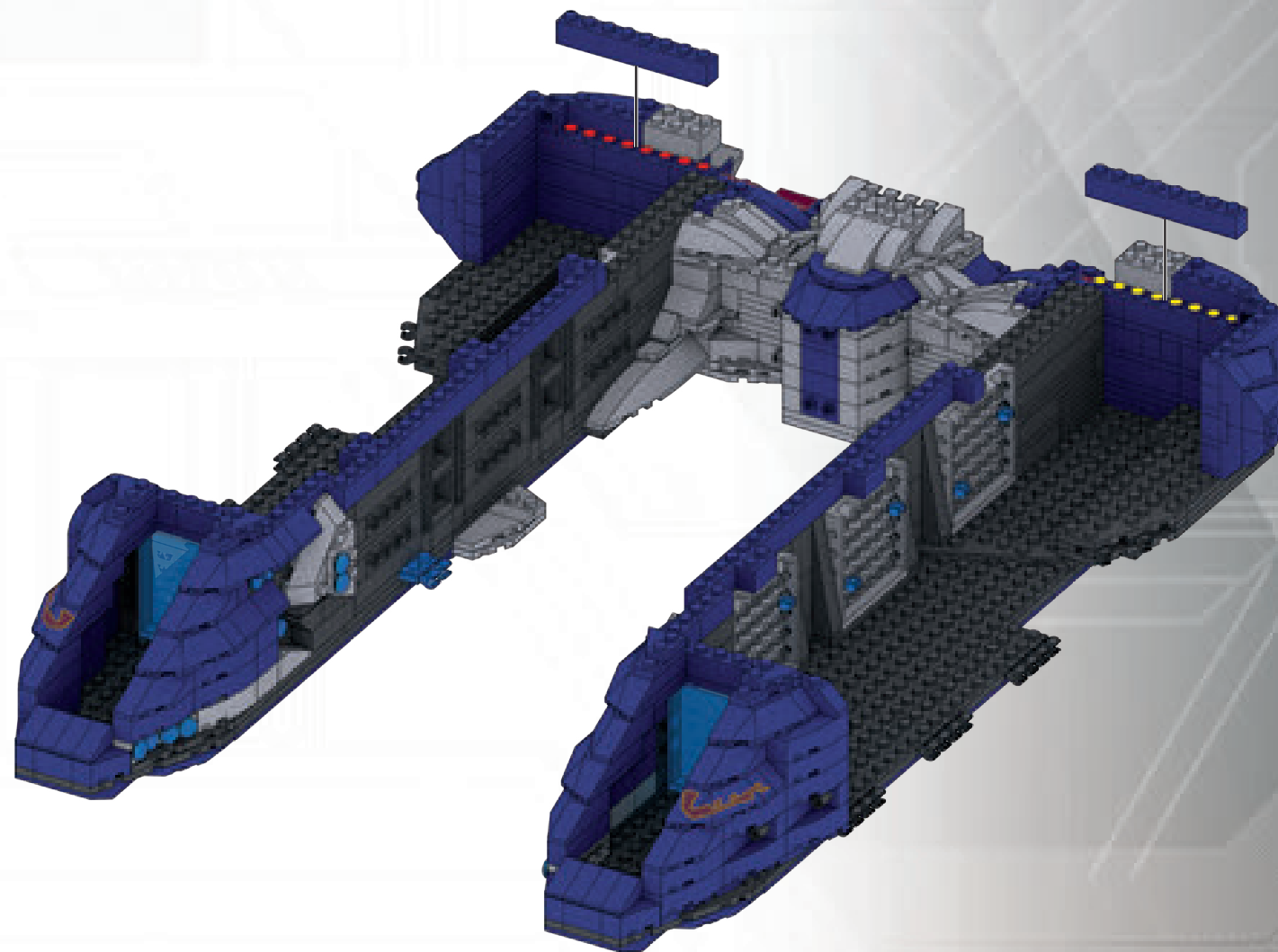
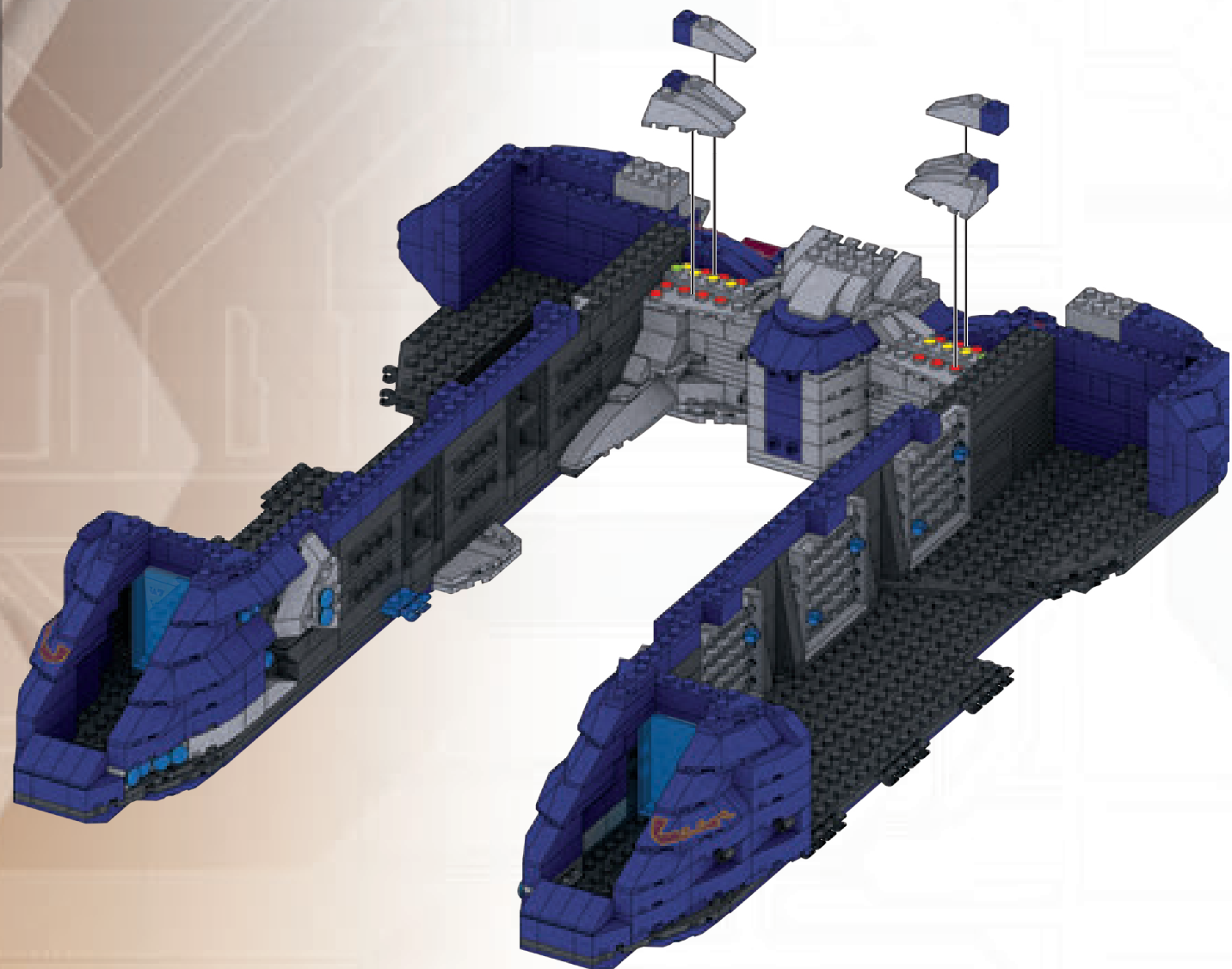

**28**



6X 2X

**29**



2X 4X 2X

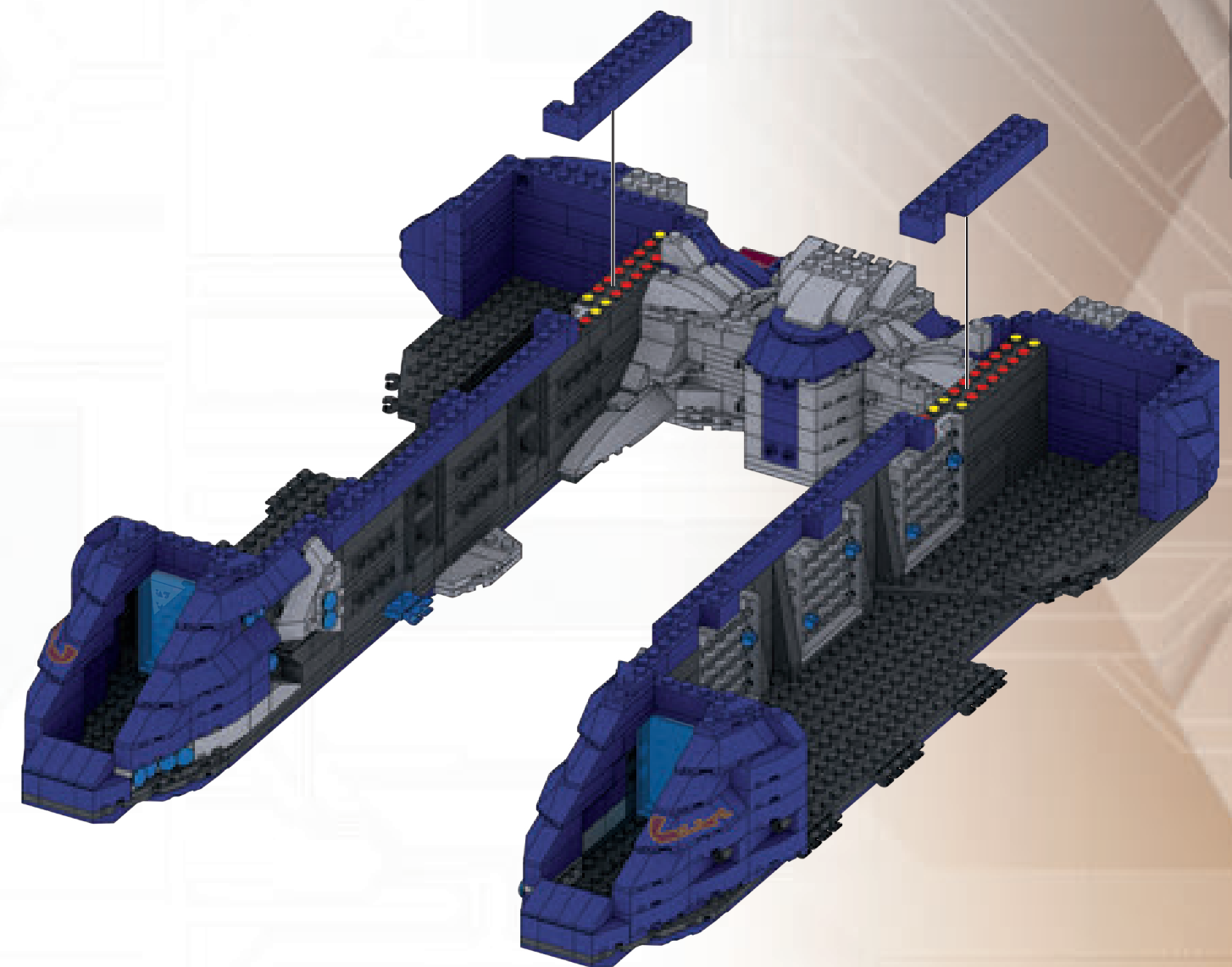

3

30



1

2

X2

3

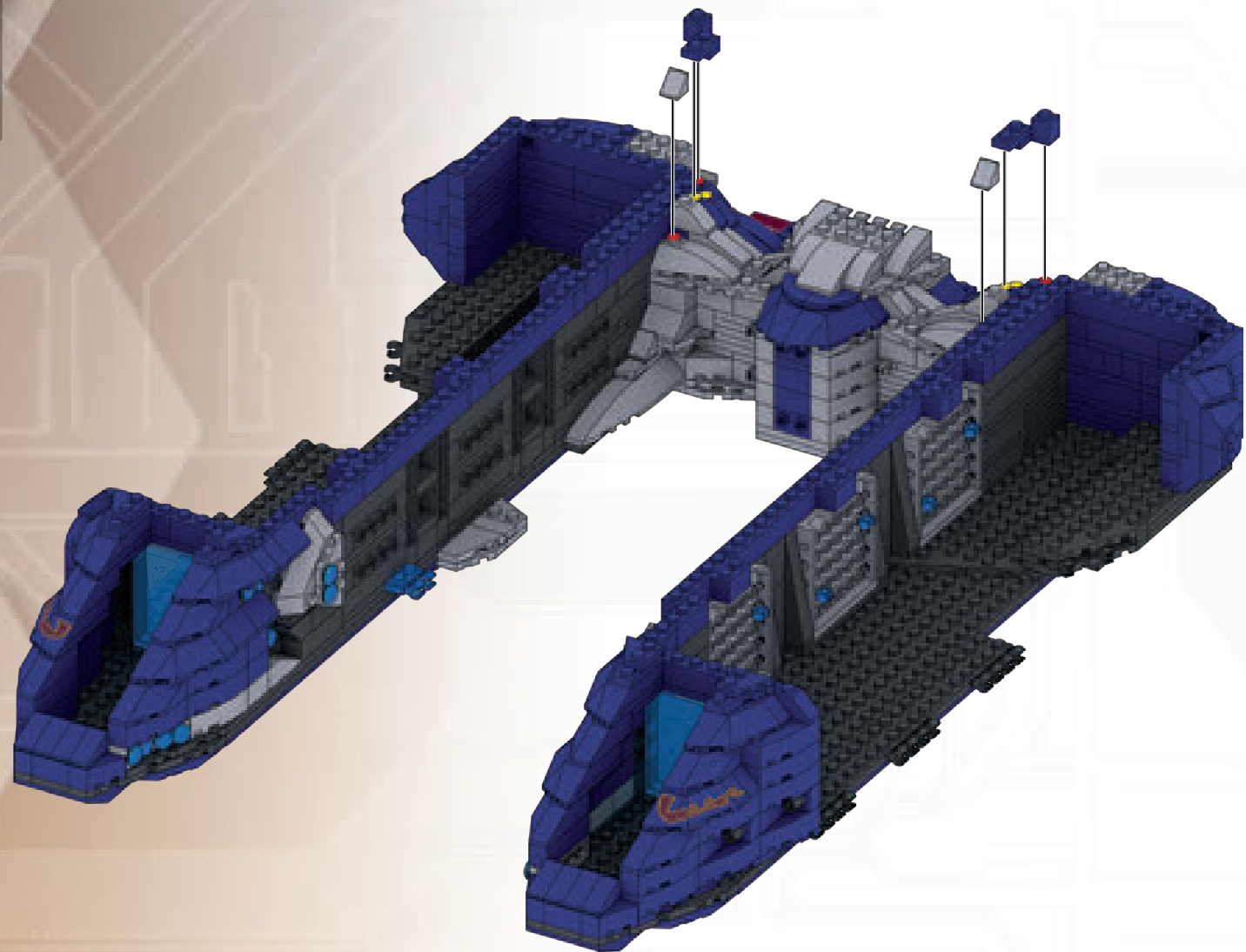

1

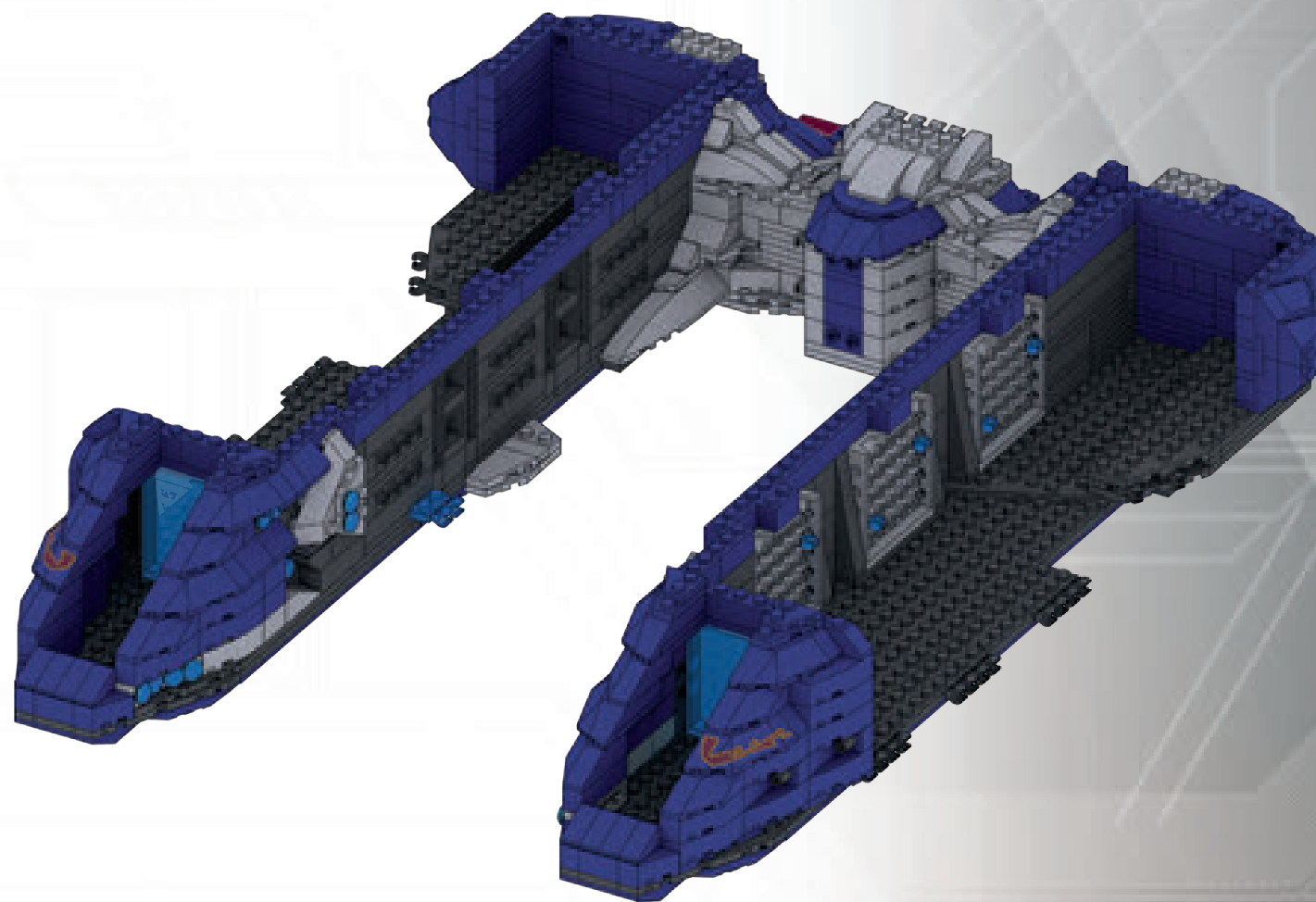

2

**31**

1X      2X

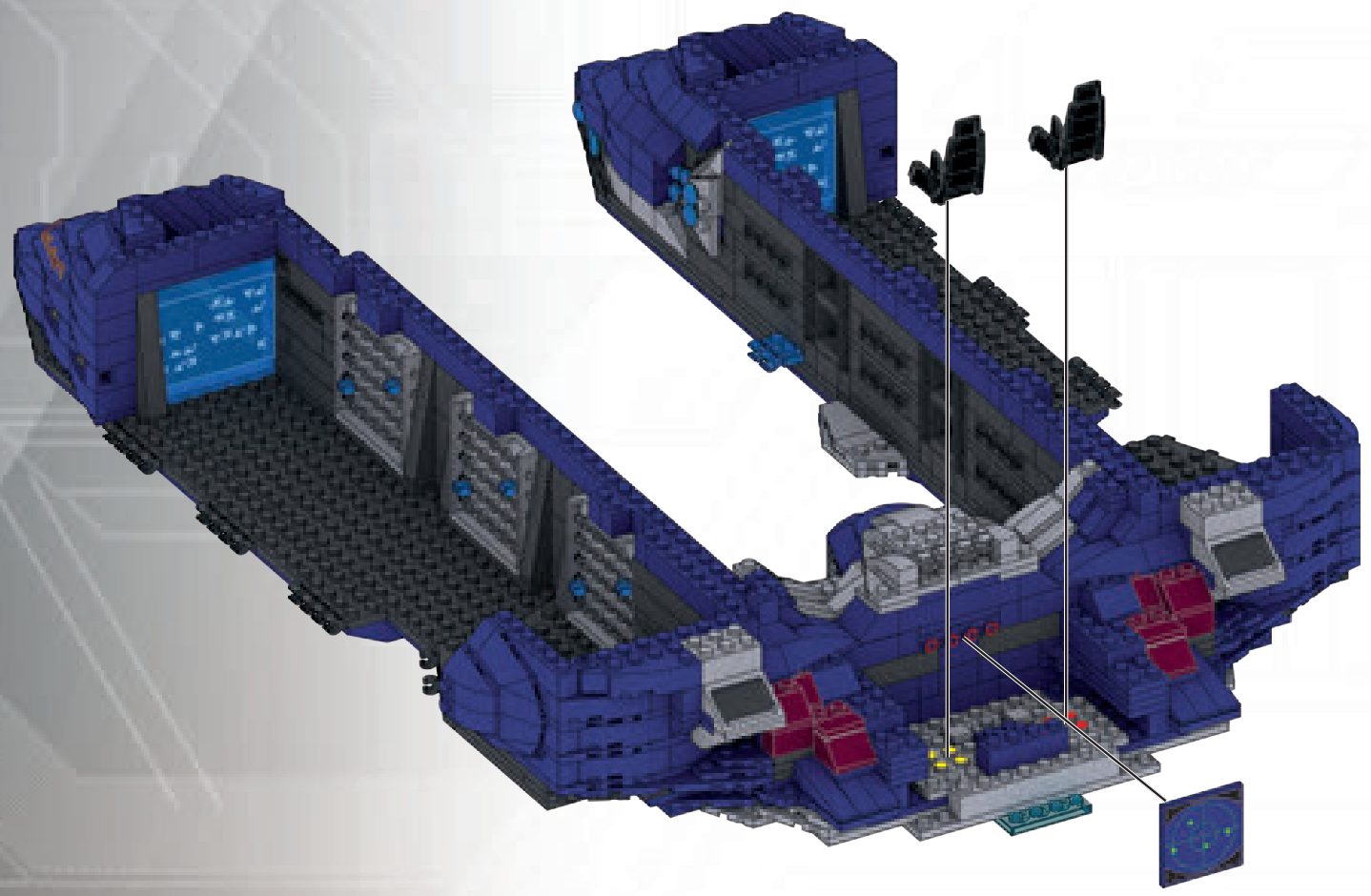

1

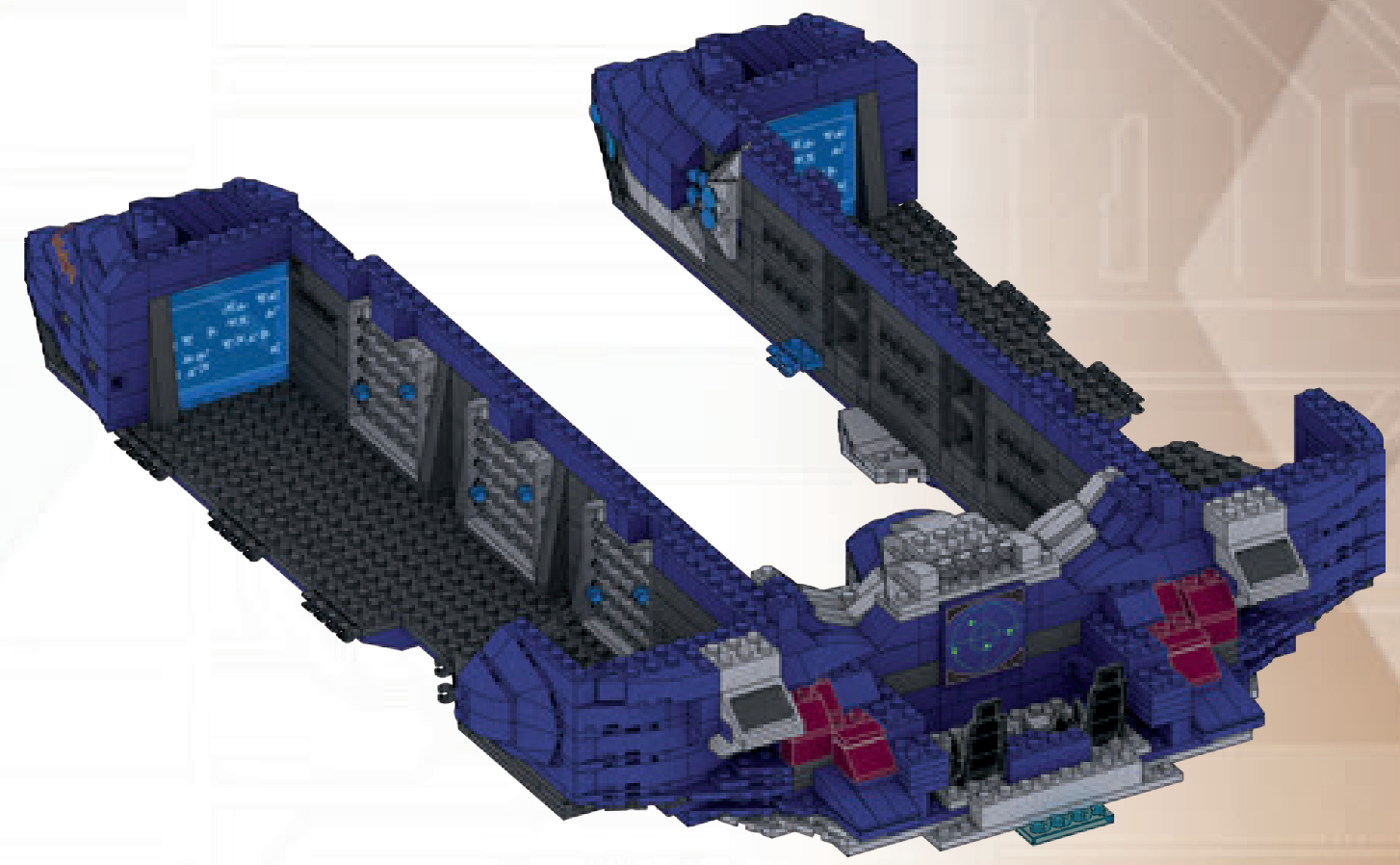

2

3





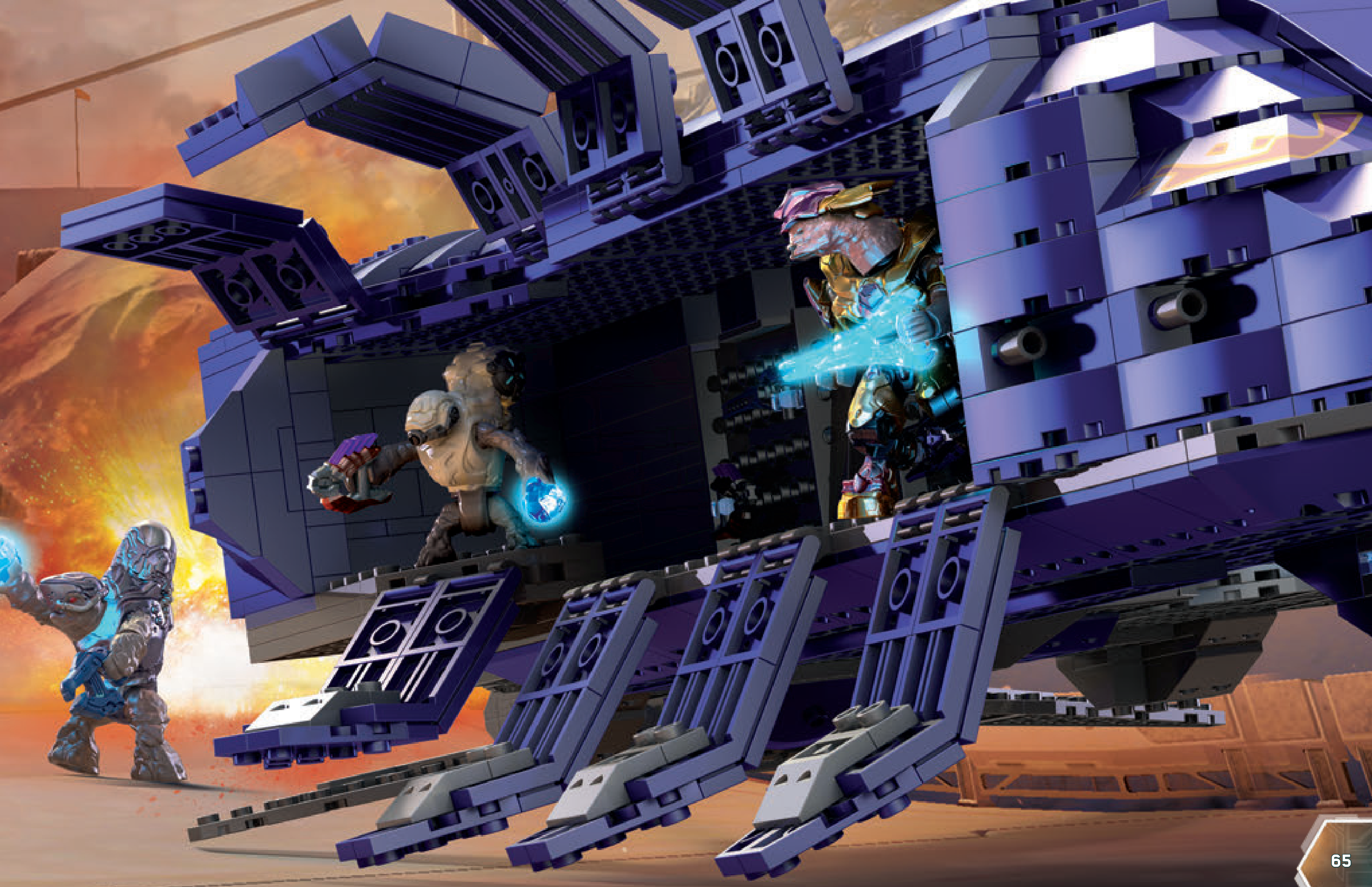



**SECTION • SECCIÓN • ABSCHNITT**  
**SECTIE • SEZIONE • SECÇÃO**



4

66-93



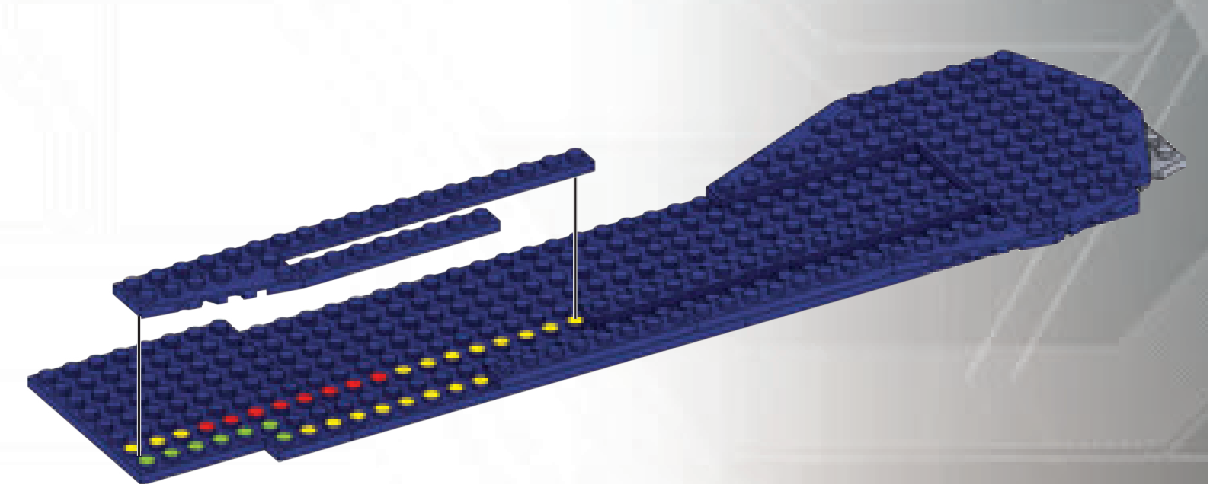
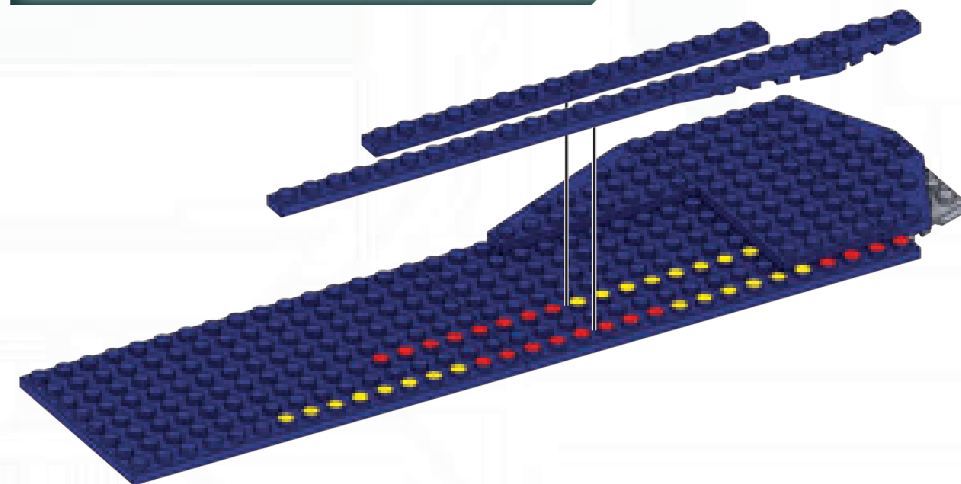
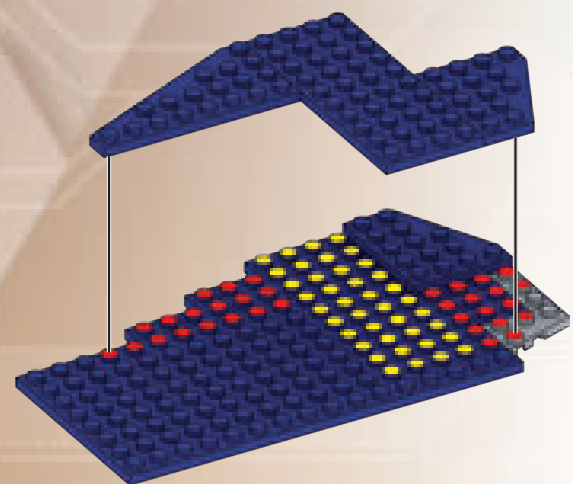
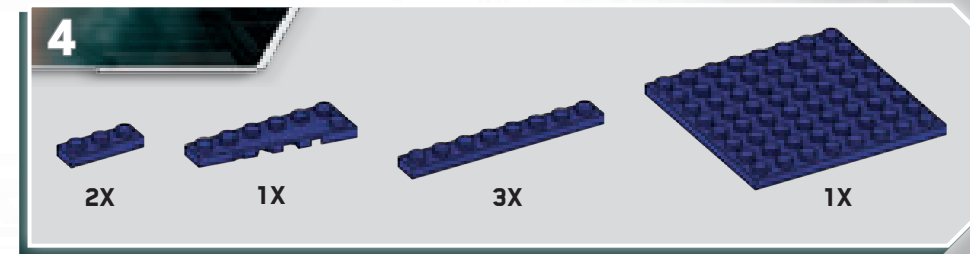
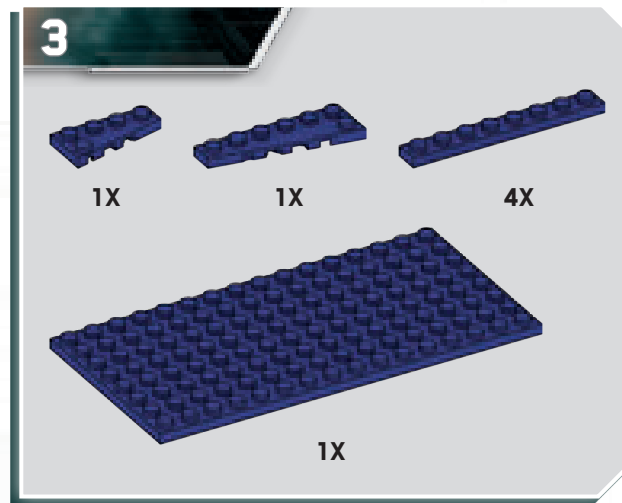
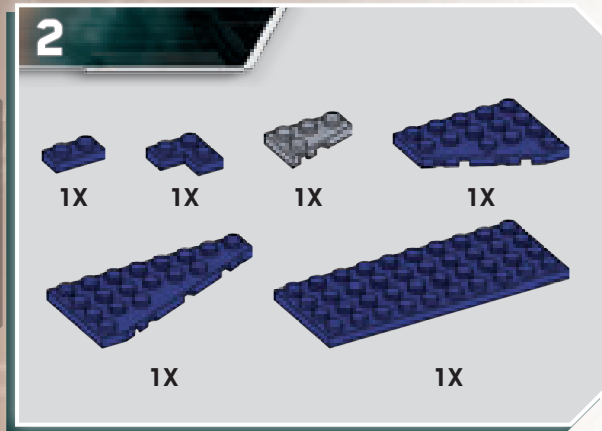
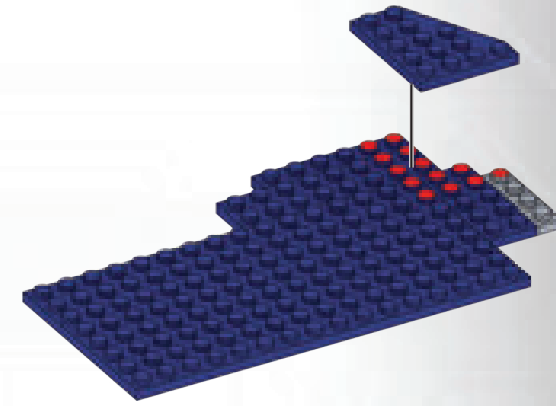
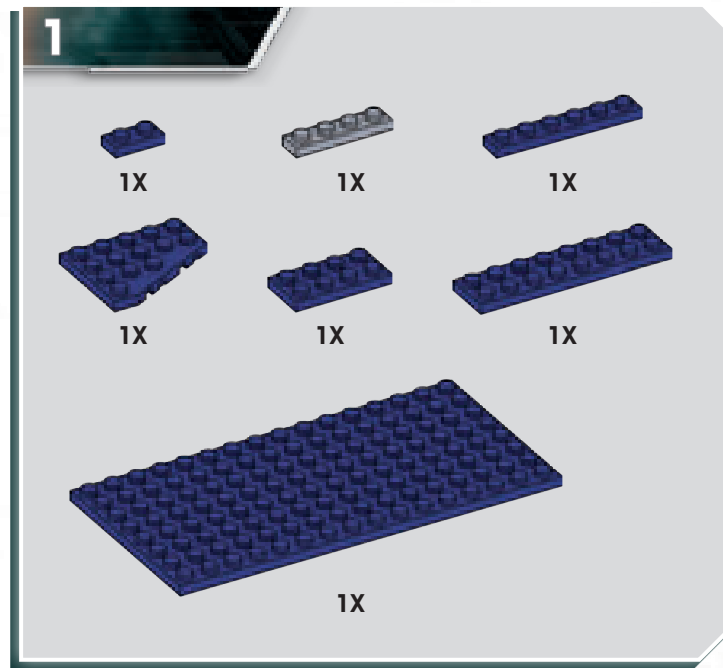

**5**

1X 1X 2X 1X

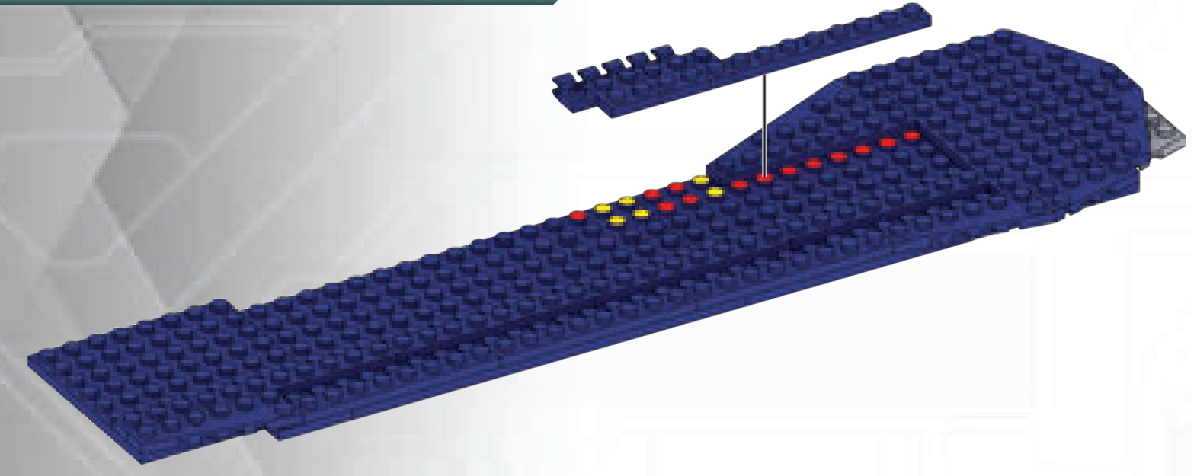

**6**

1X 1X 2X 2X 1X 2X 2X

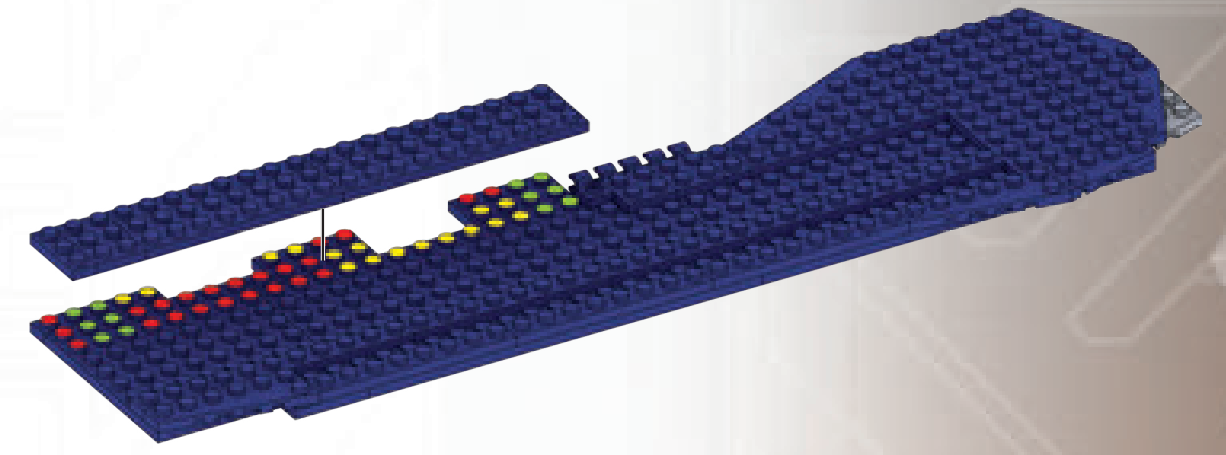

**7**

2X 1X 1X 1X 2X 6X

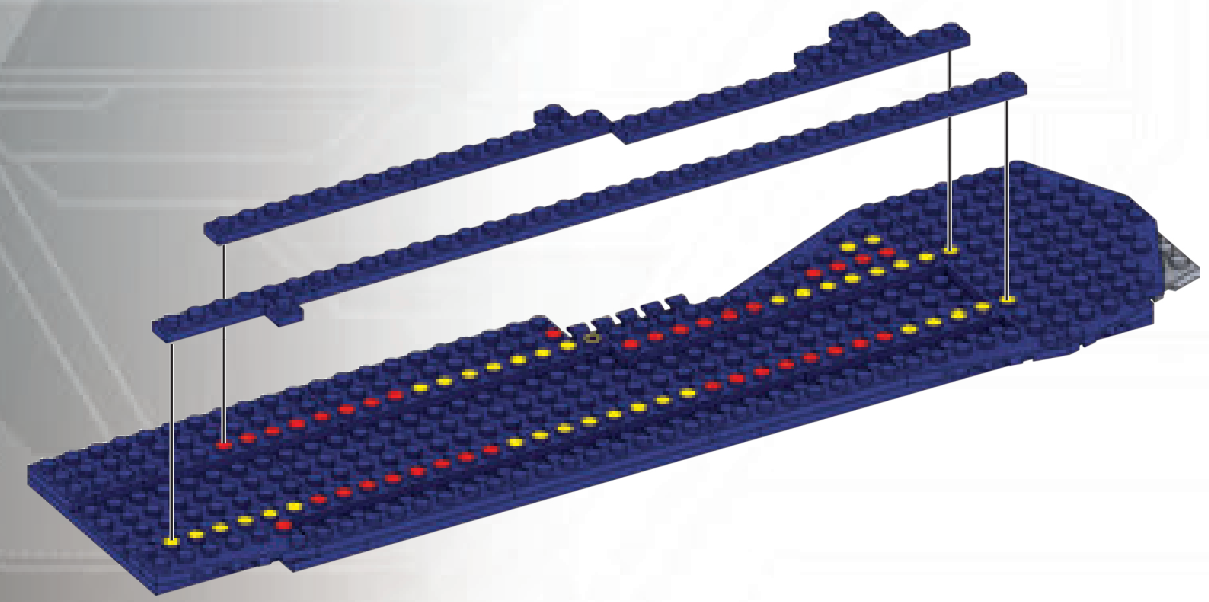

**8**

2X 1X

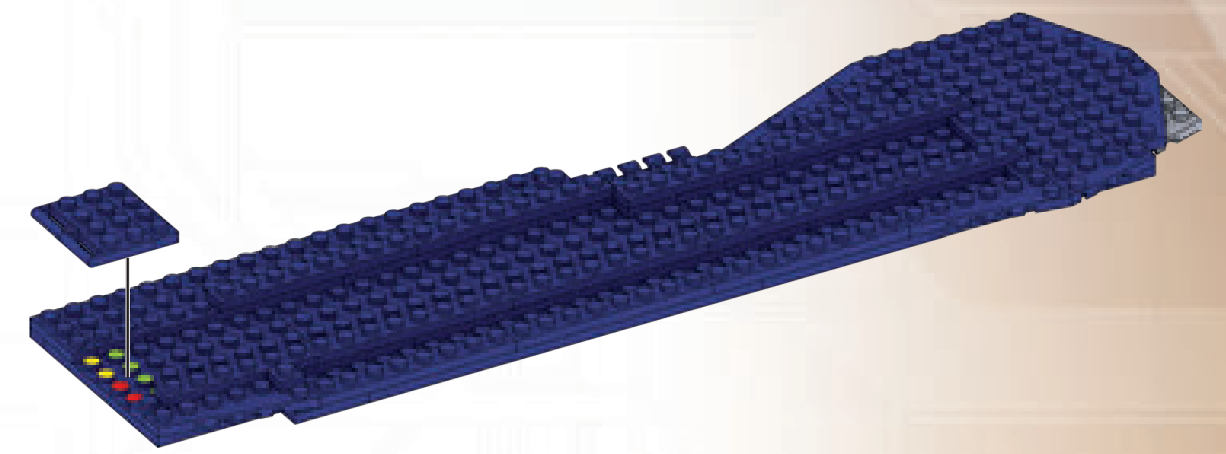

**4**