

5

1X 1X 2X 1X

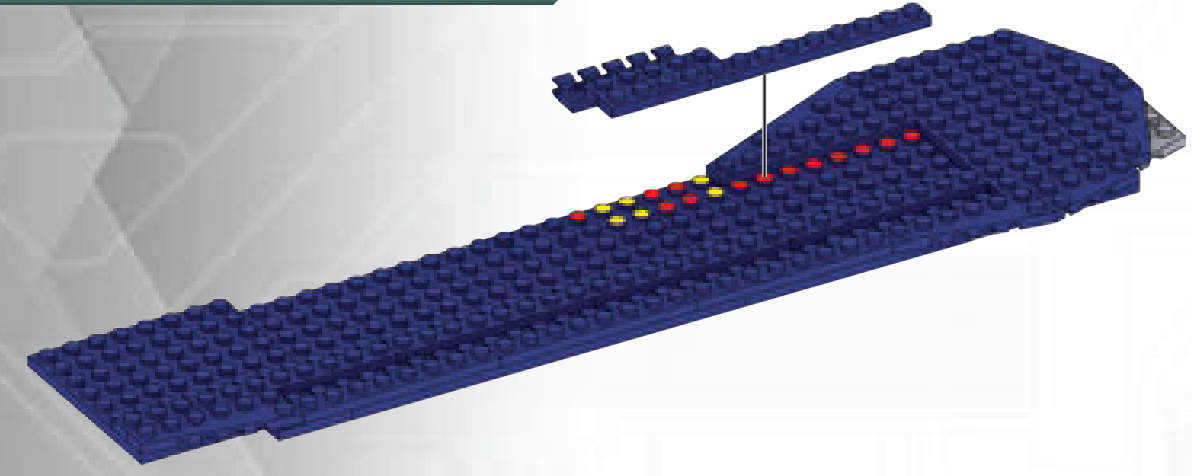

6

1X 1X 2X 2X 1X 2X 2X

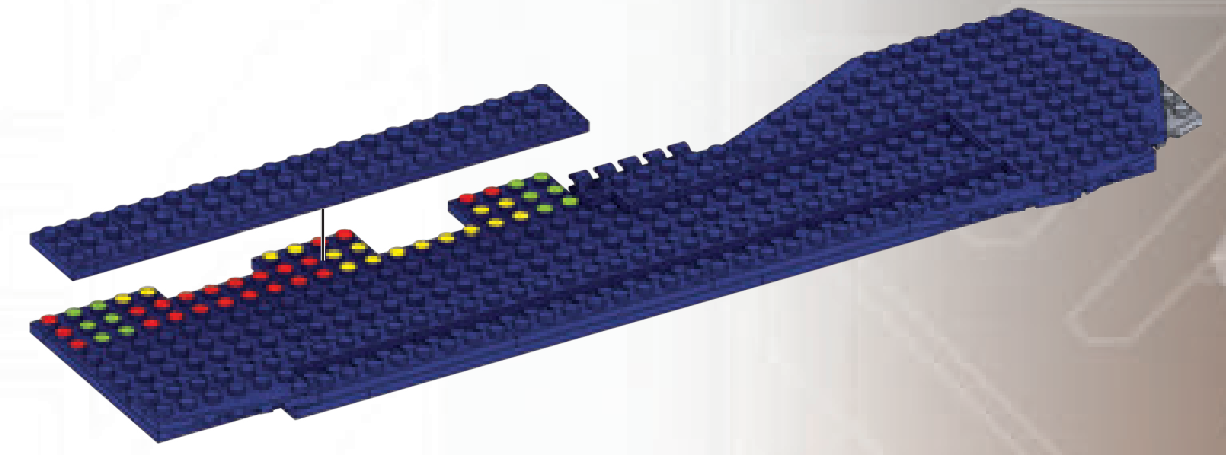

7

2X 1X 1X 1X 2X 6X

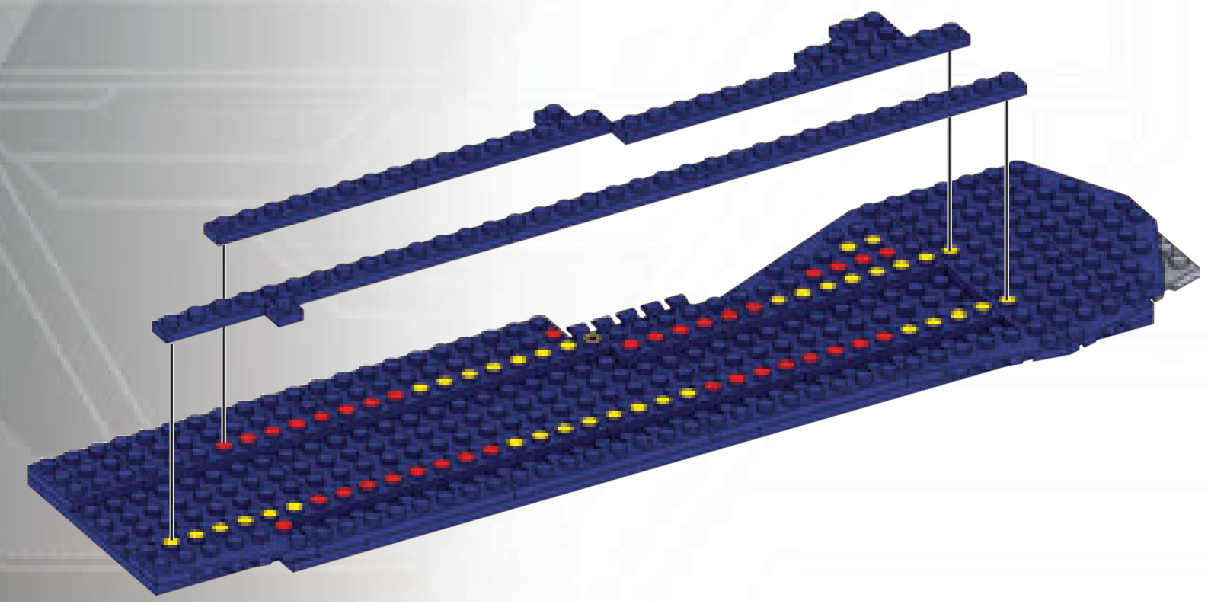

8

2X 1X

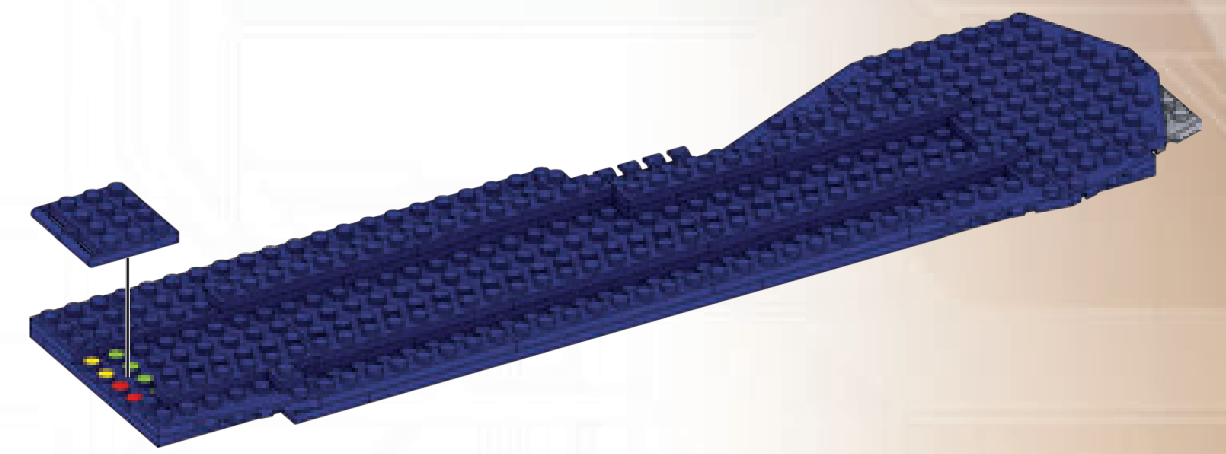

4

9



10

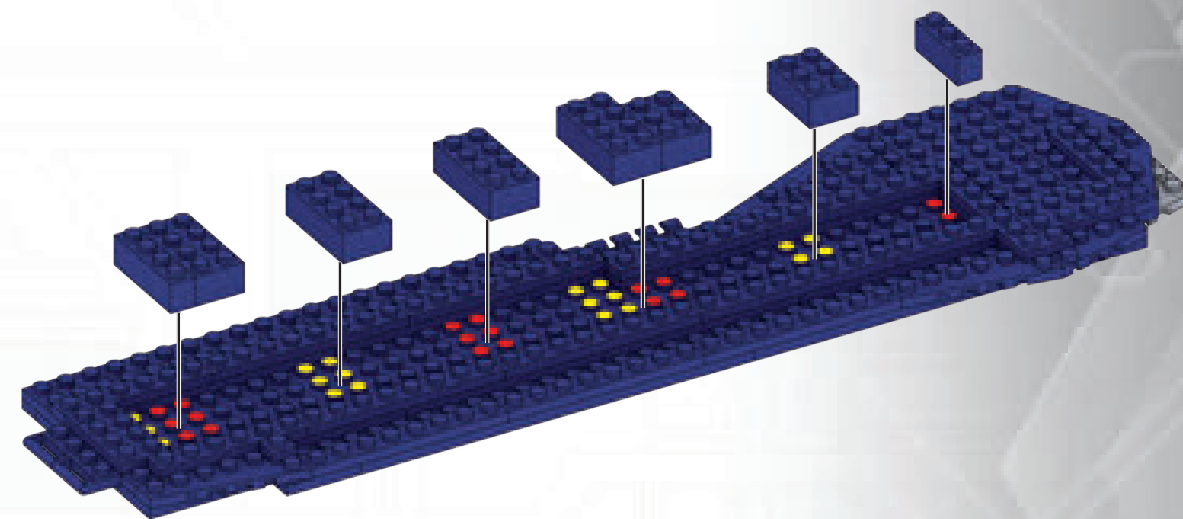
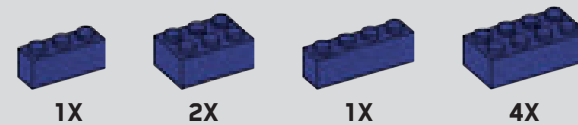

11

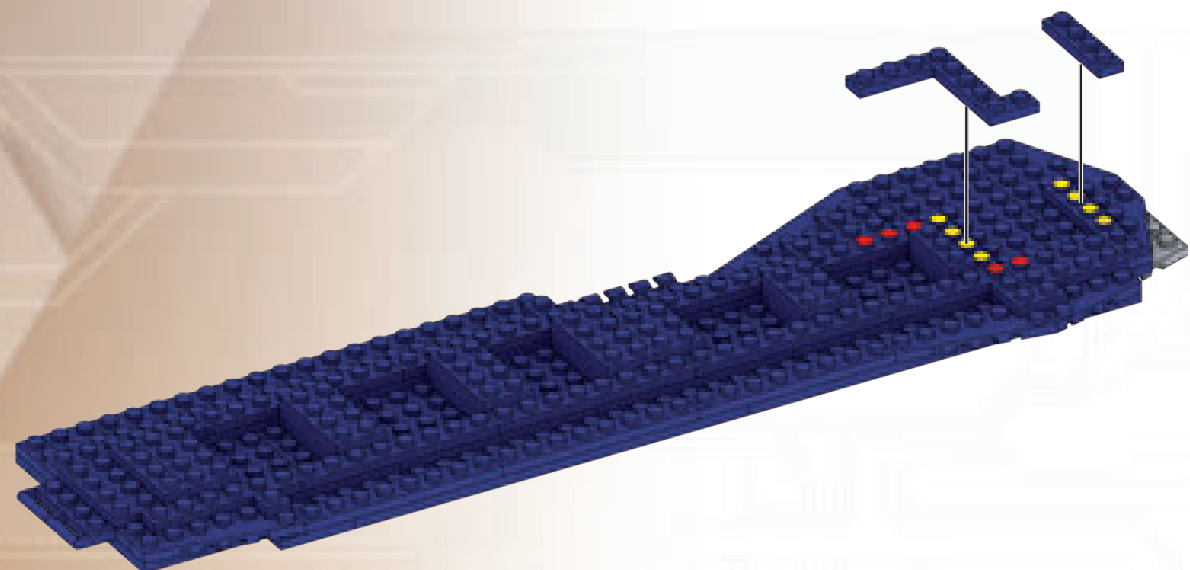

12

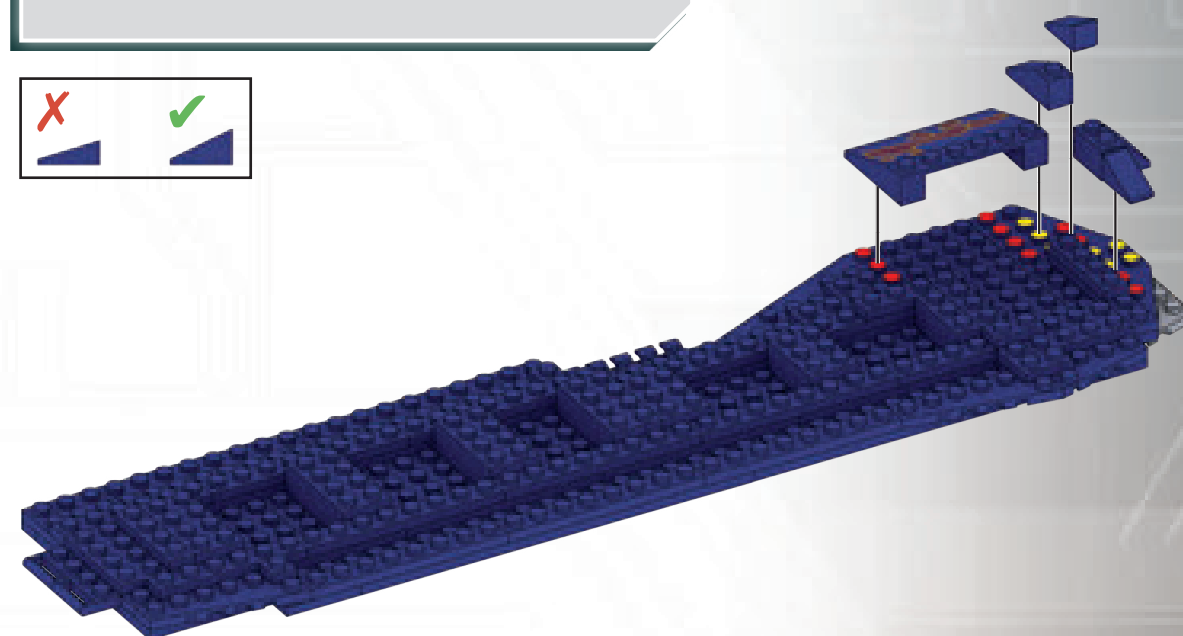
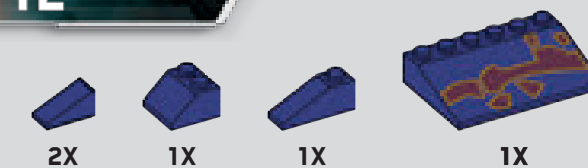

13

1X 8X 2X

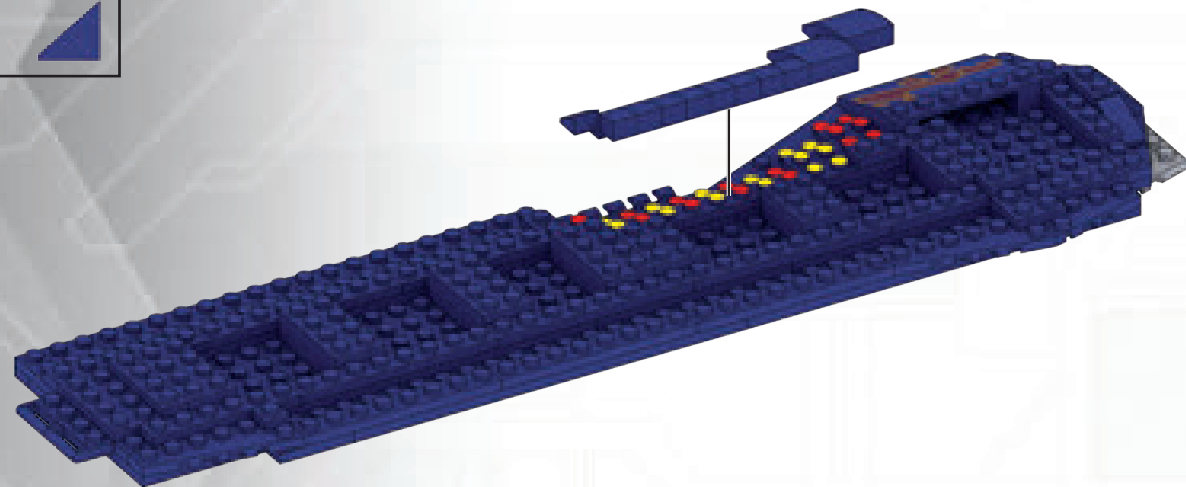

14

1X 9X

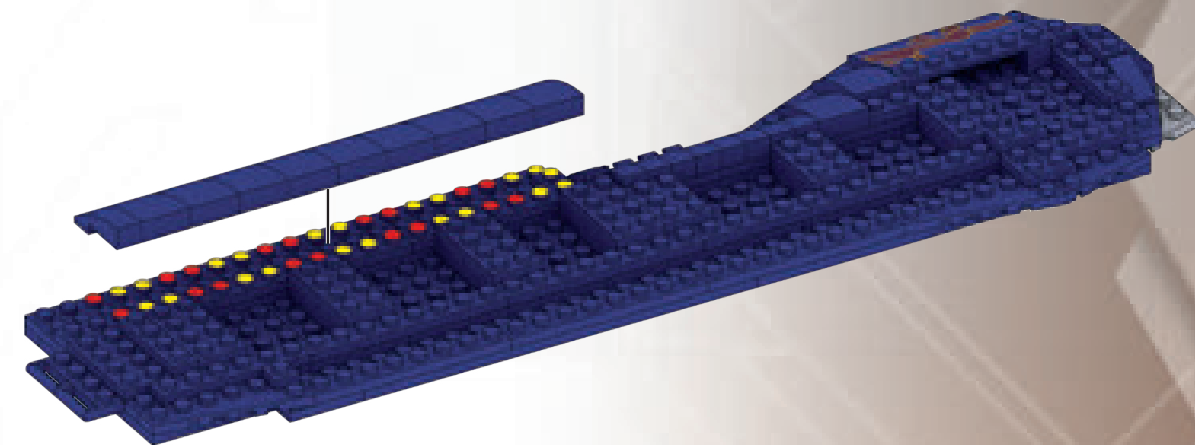

15

1X 1X 2X

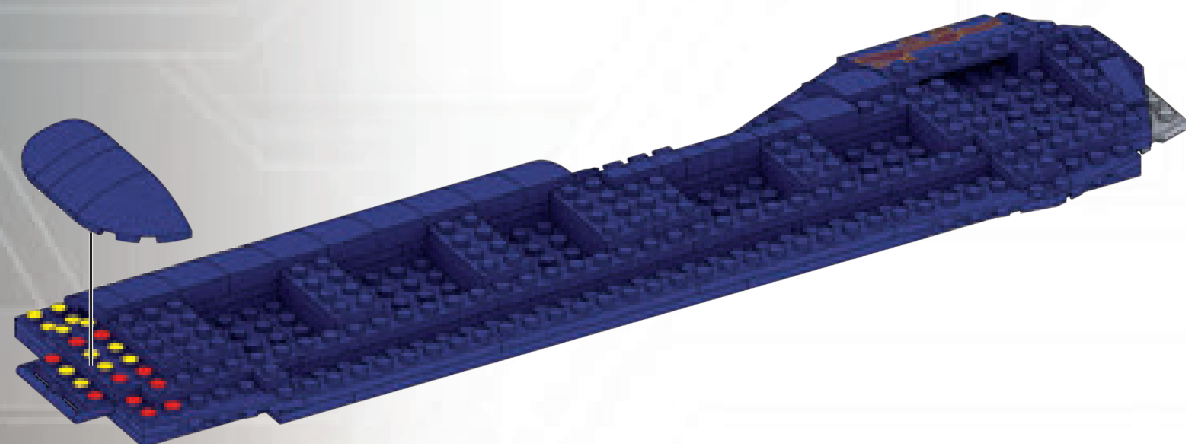

16

1X 10X

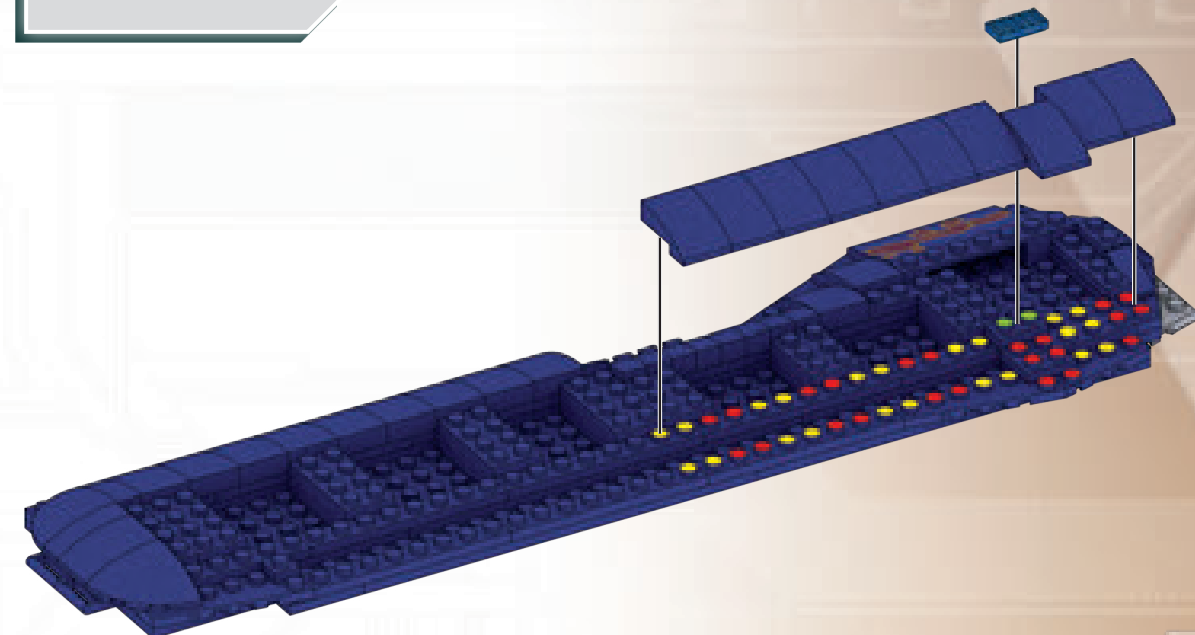

17

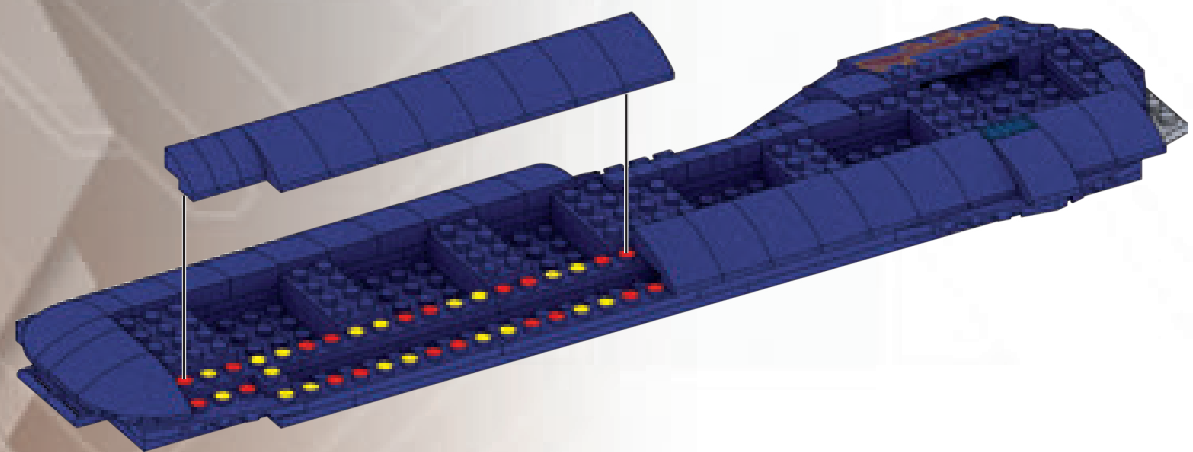
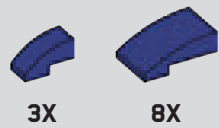

18

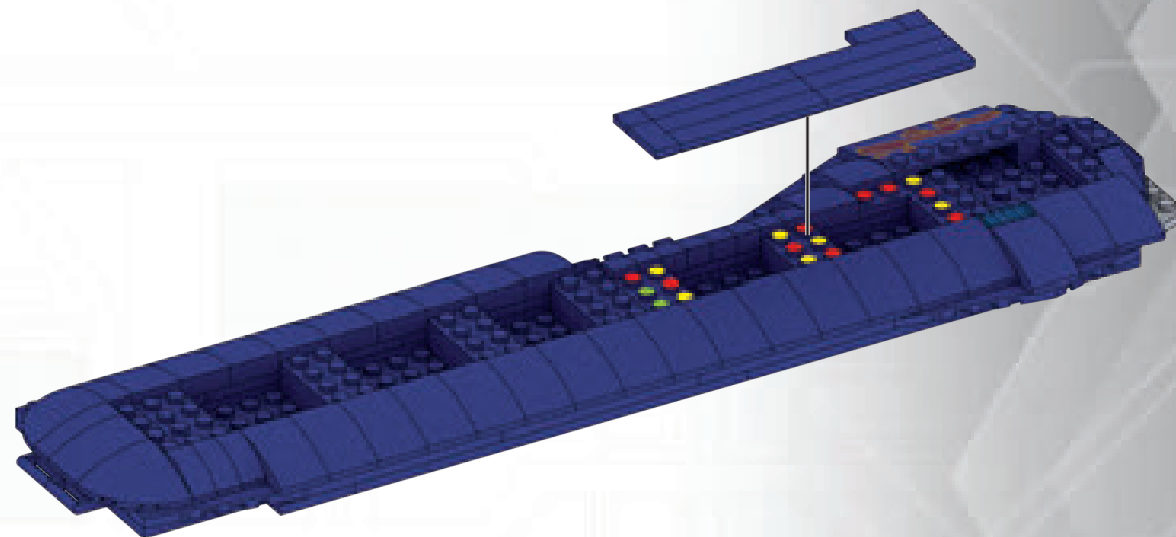

19

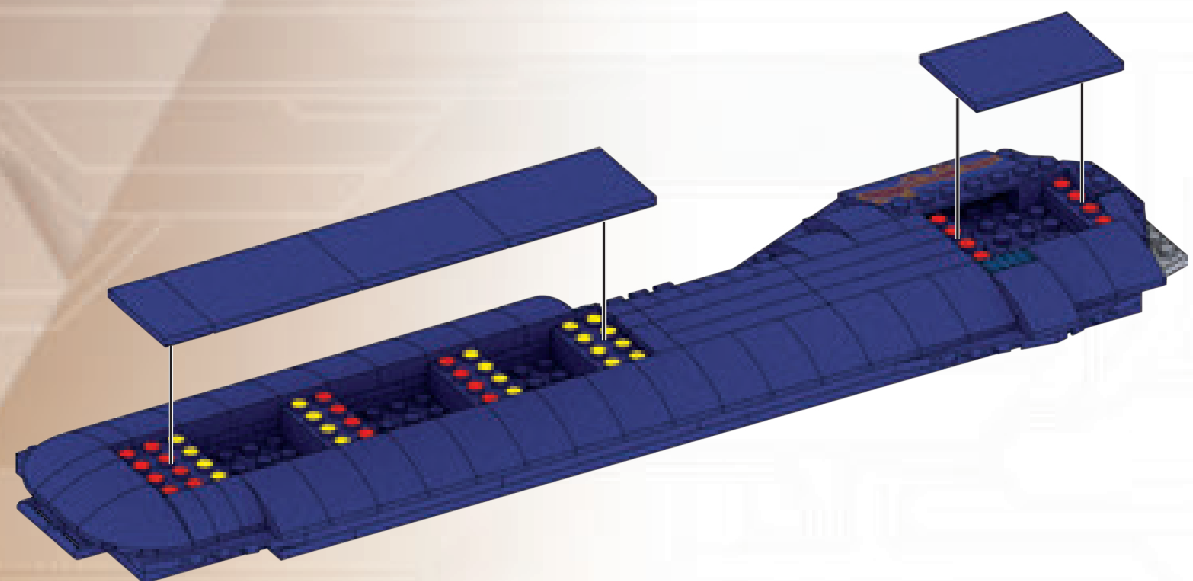
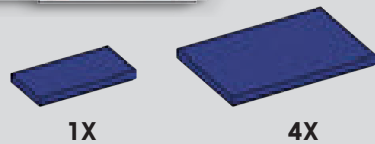

1

2

20



6X 2X

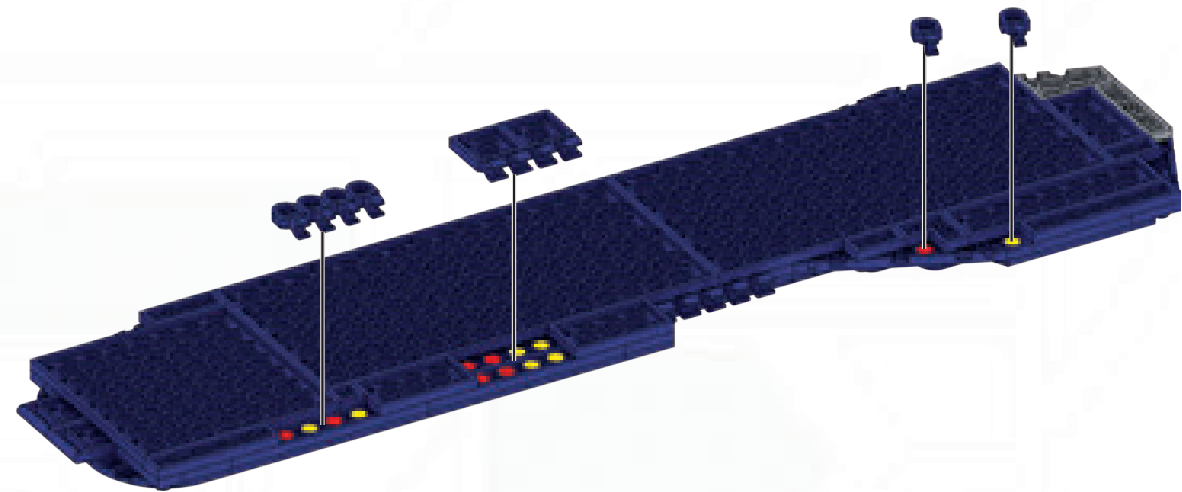

21

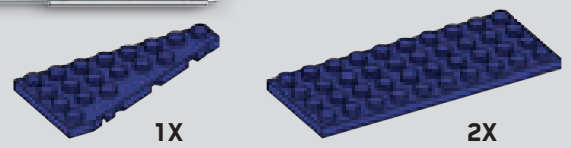

1X 2X

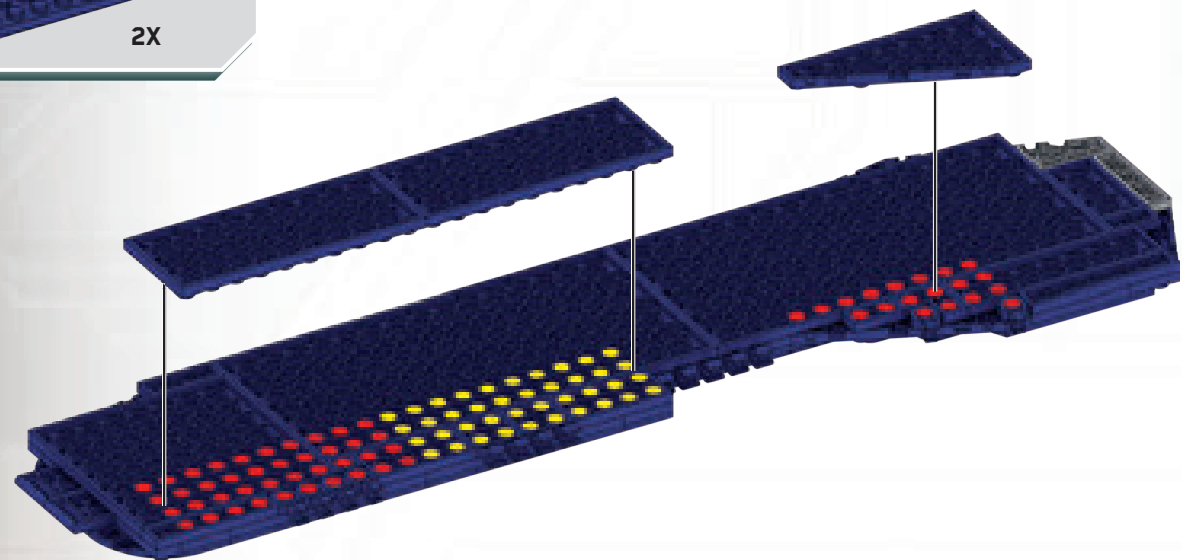

1

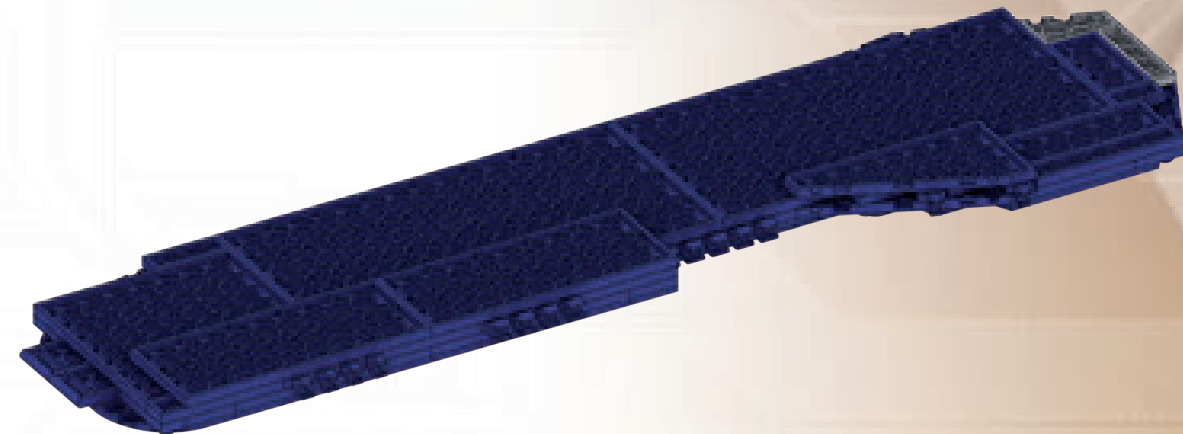

2

4



22

1X 1X 1X

1X 1X 1X

1X

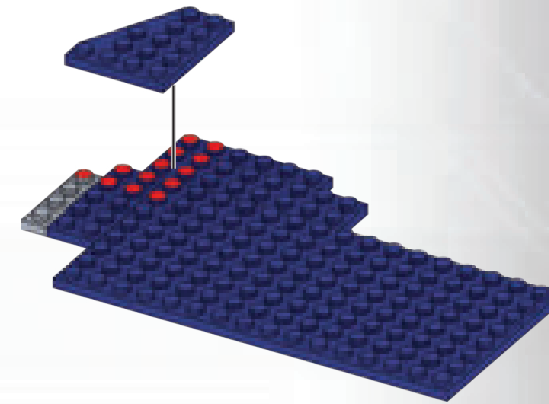

23

1X 1X 1X 1X

1X 1X

24

1X 1X 4X

1X

25

2X 1X 3X 1X

4

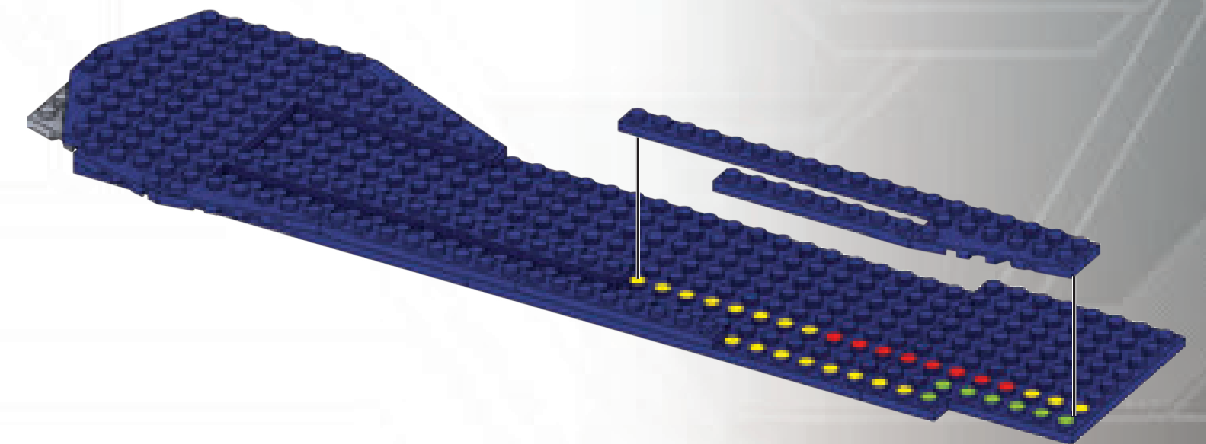
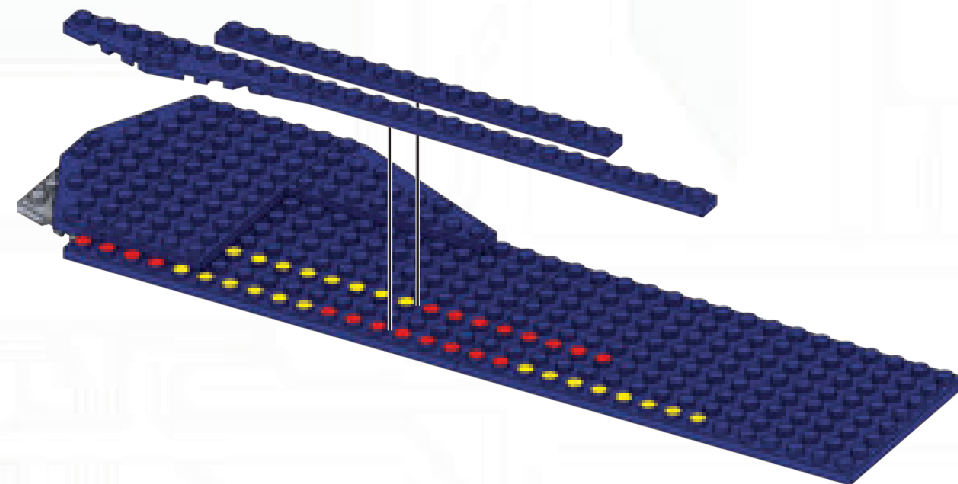
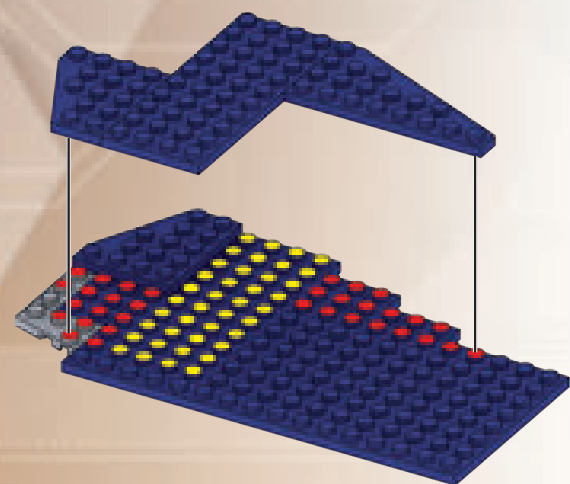

26

1X 1X 2X 1X

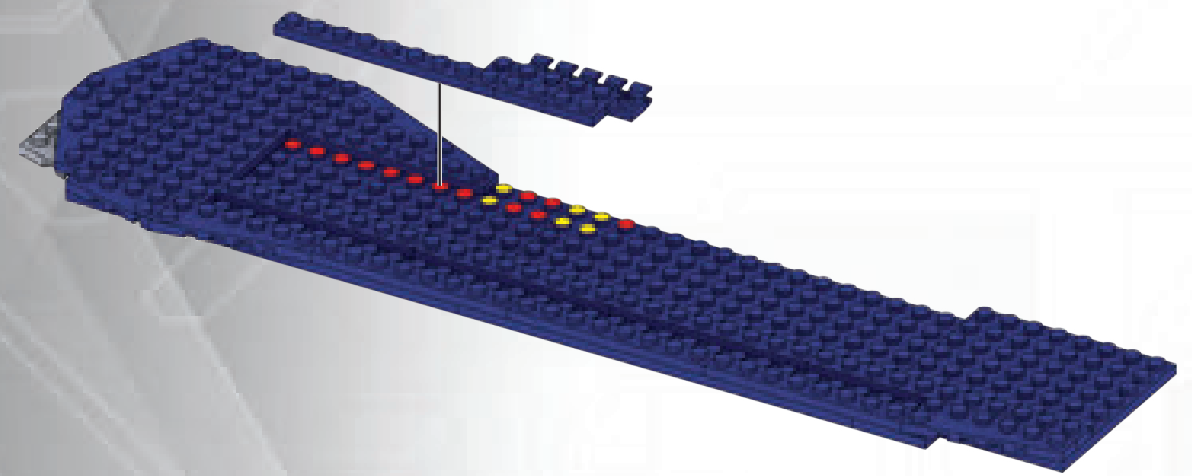

27

1X 1X 2X 2X 1X 2X 2X

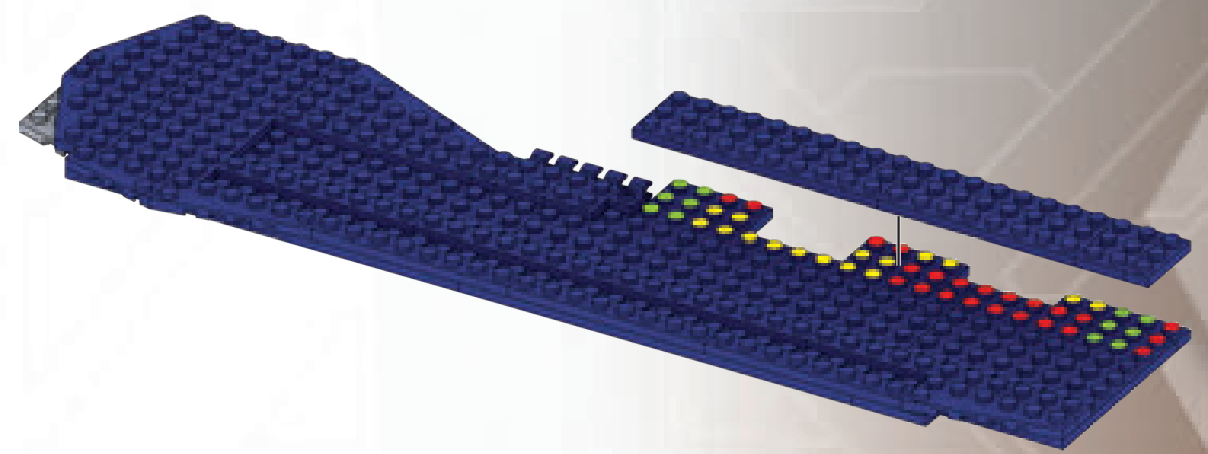

28

2X 1X 1X 1X 2X 6X

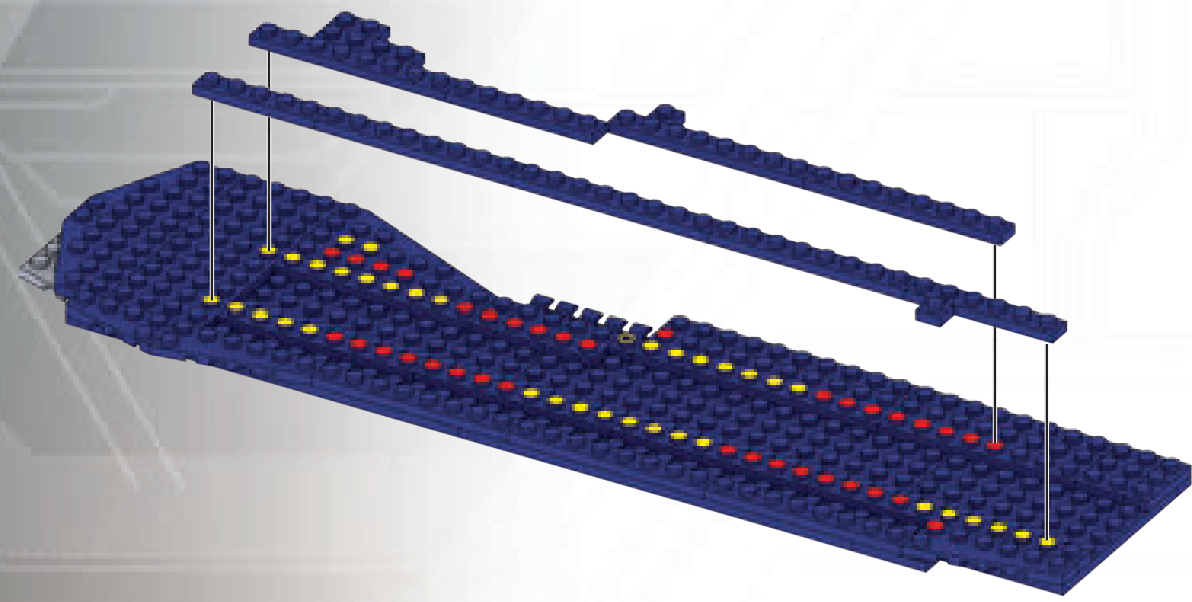

29

2X 1X

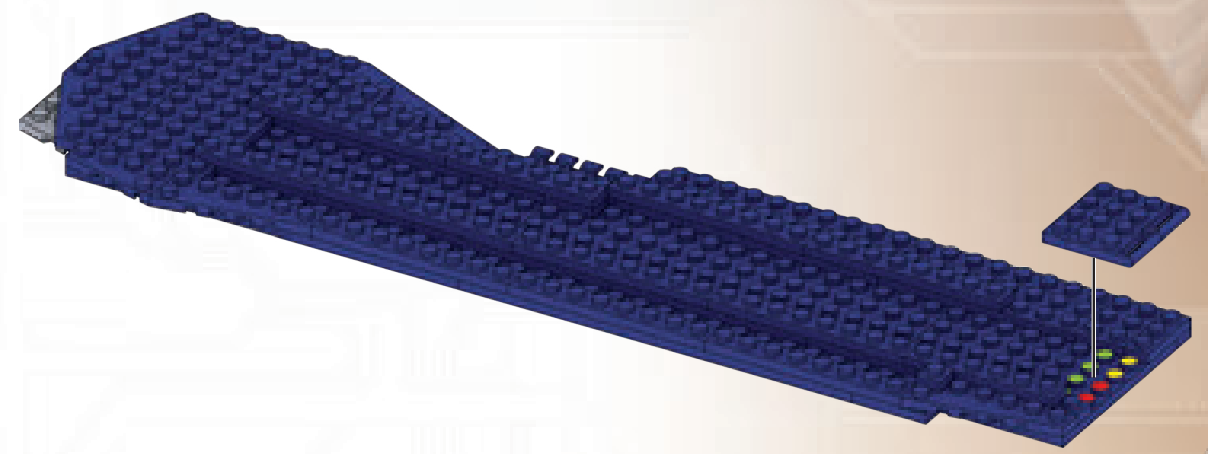

30



31

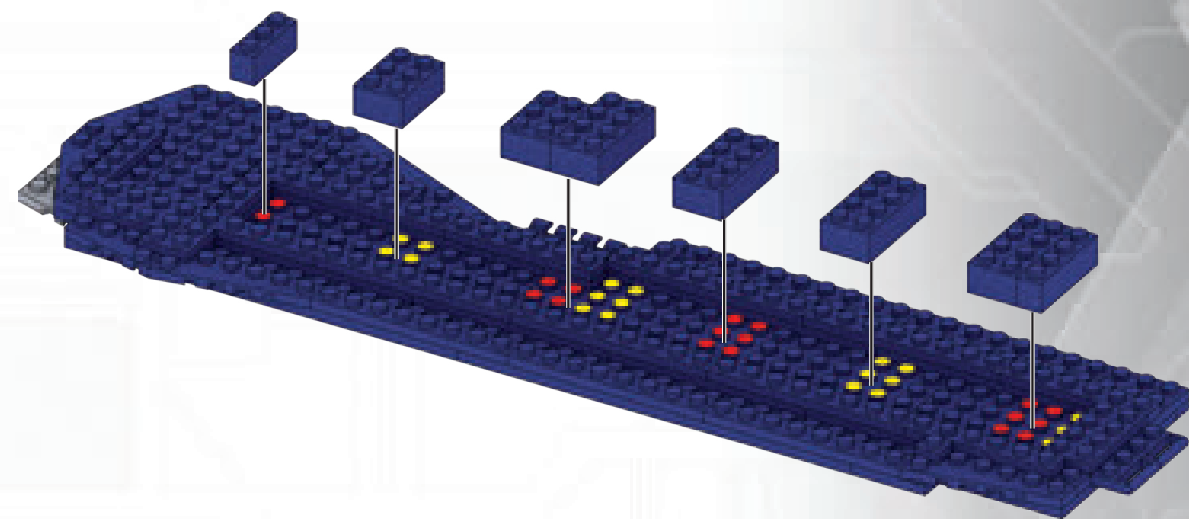
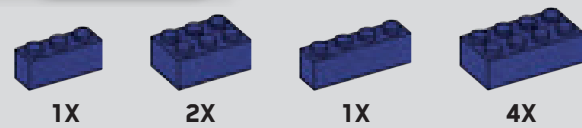

32

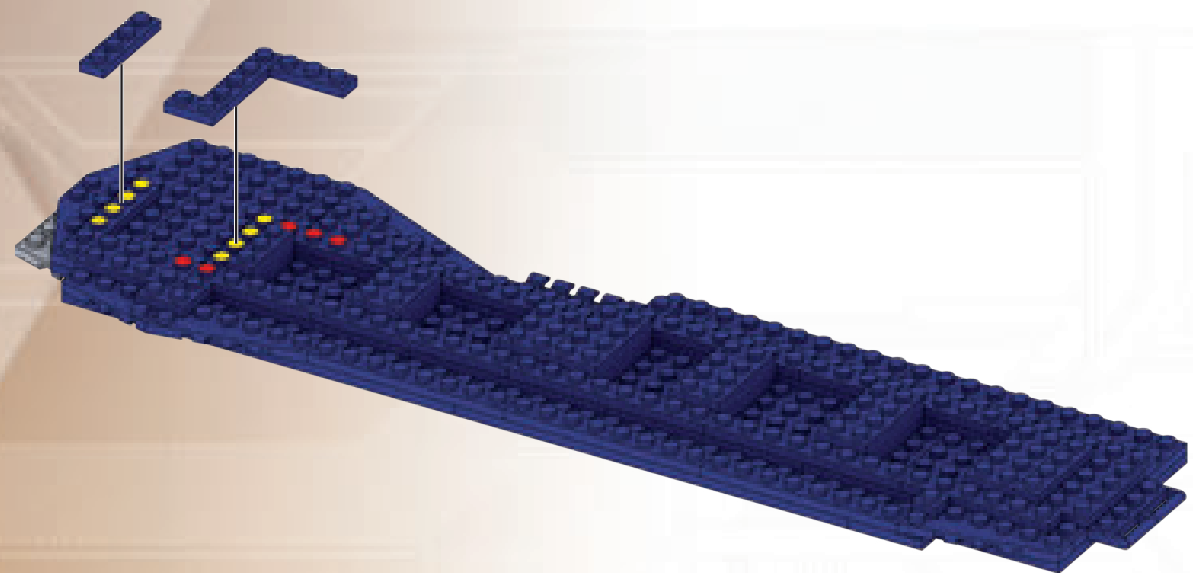

33

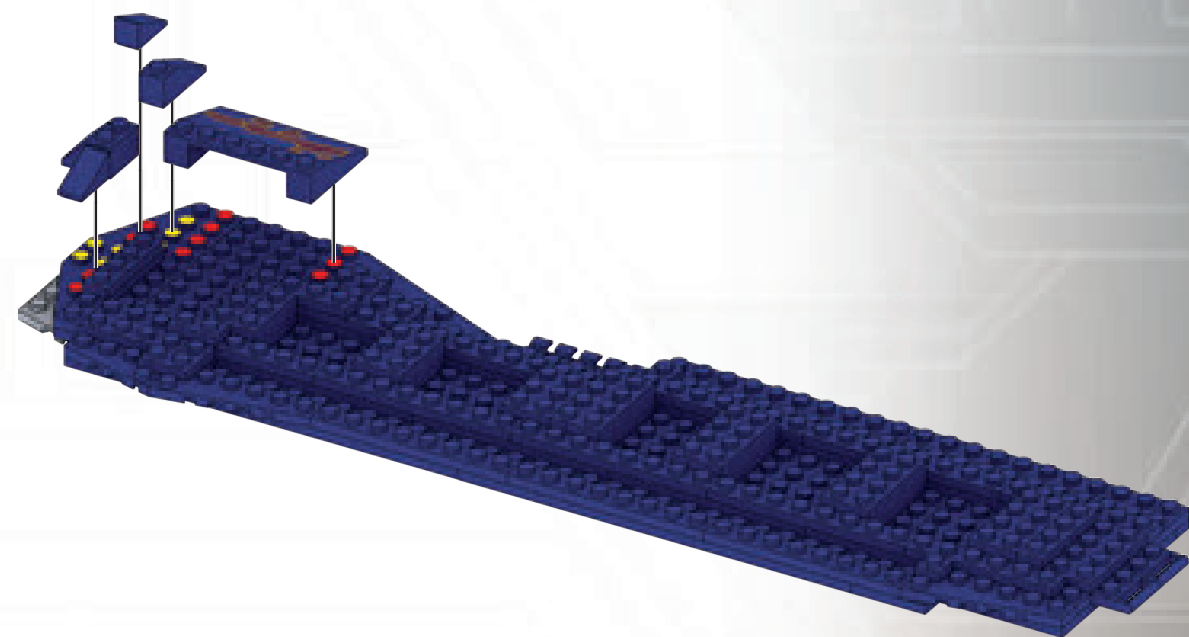
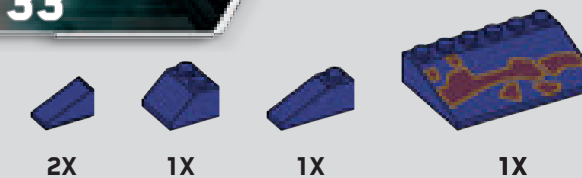

34

1X 8X 2X

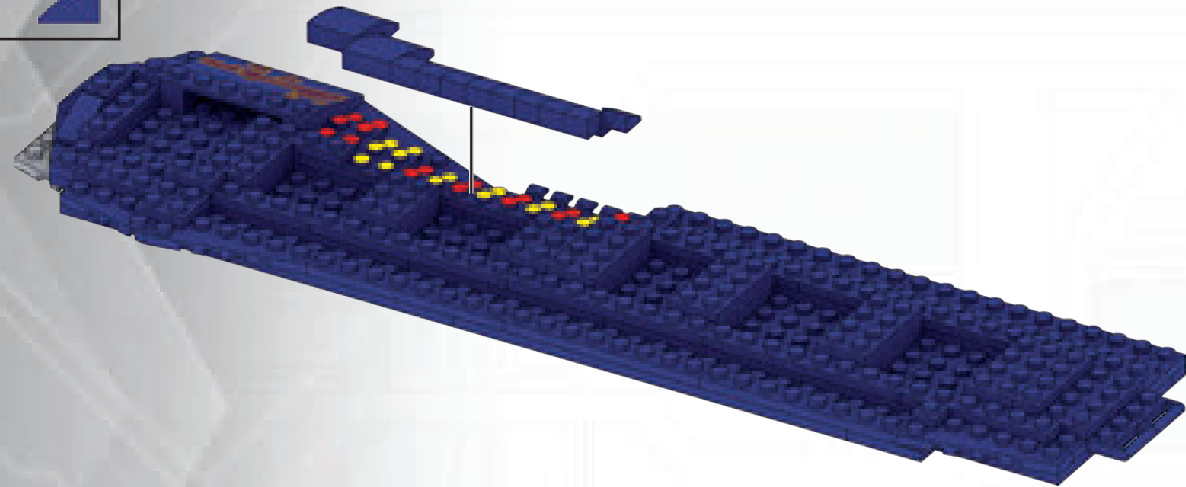
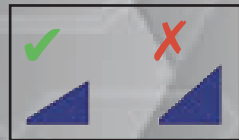

35

1X 9X

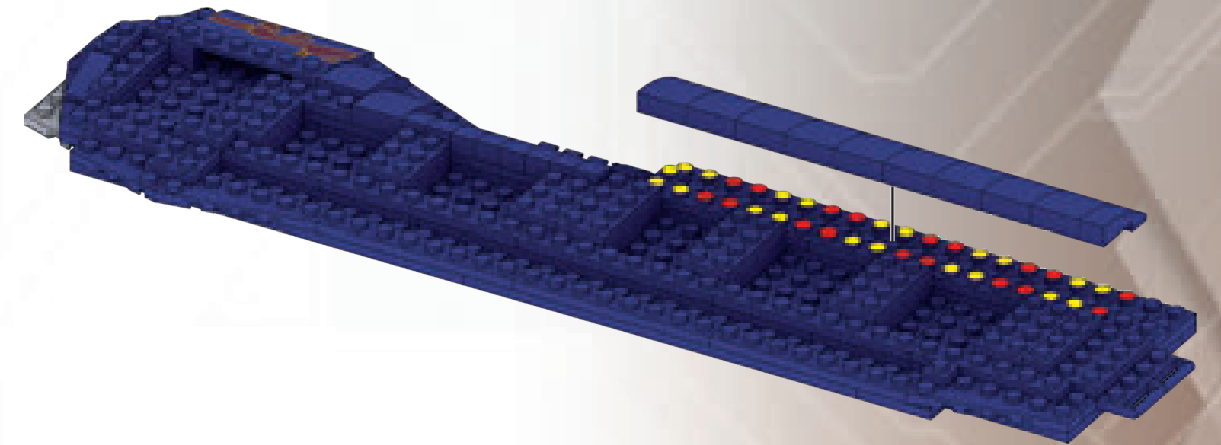

36

1X 1X 2X

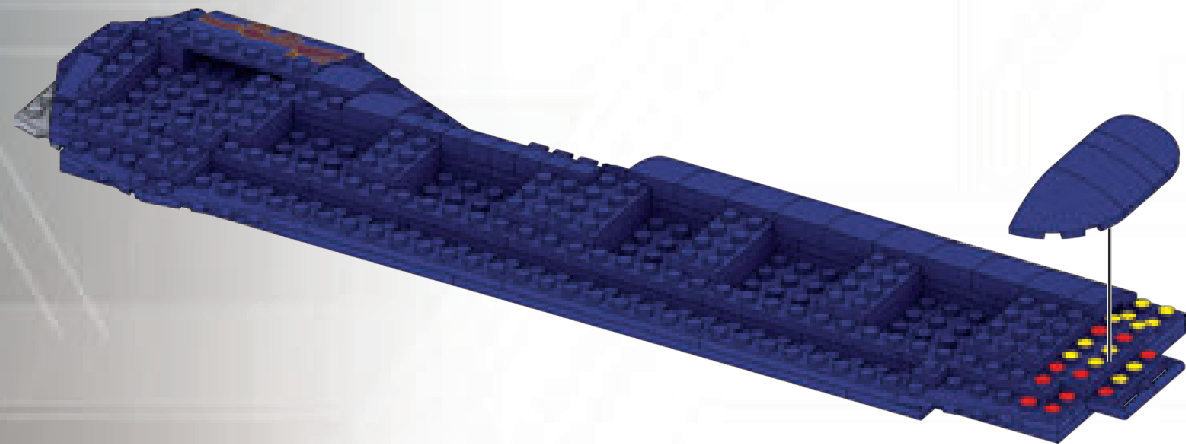

37

1X 10X

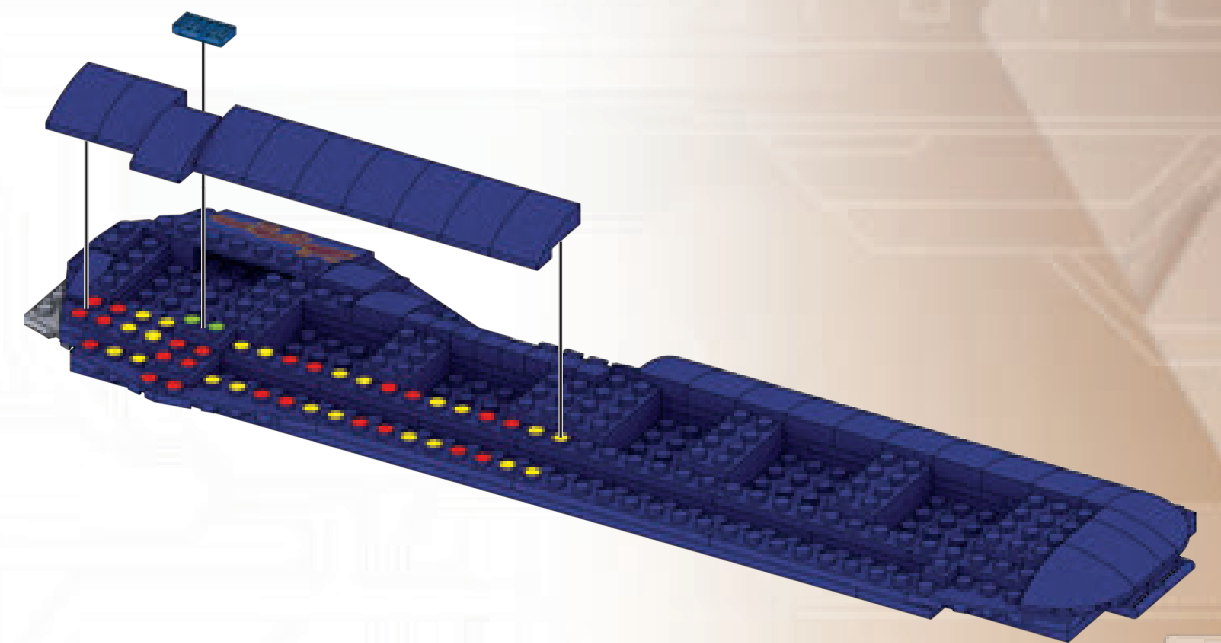

4

38

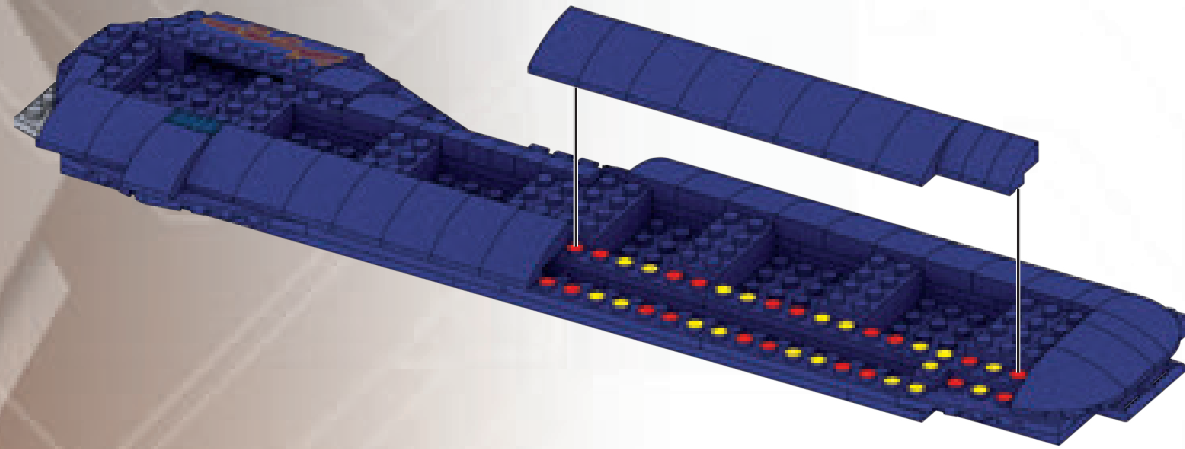
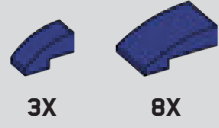

39

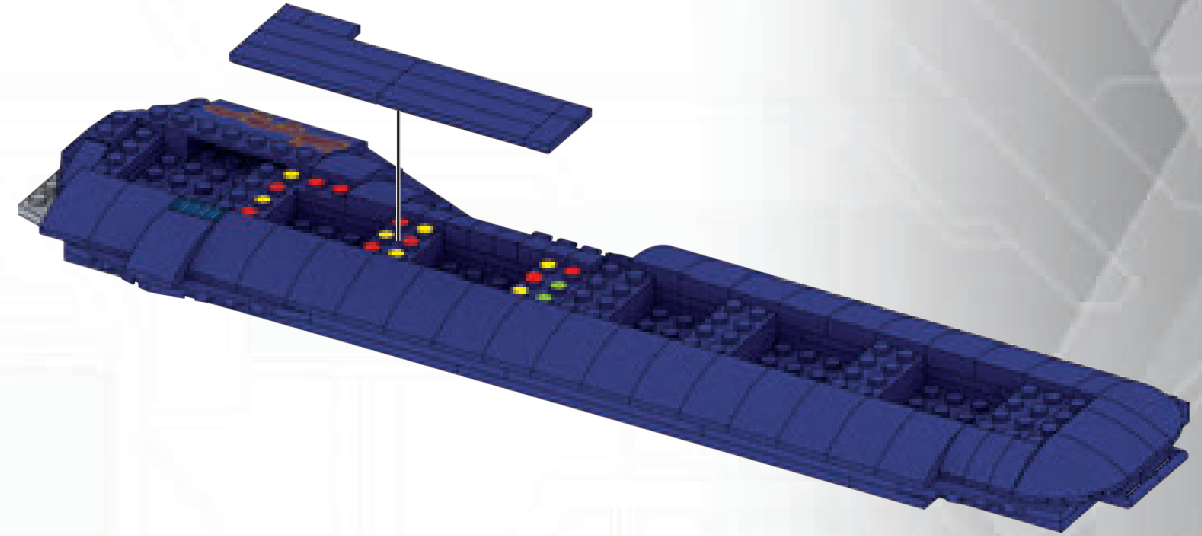

40

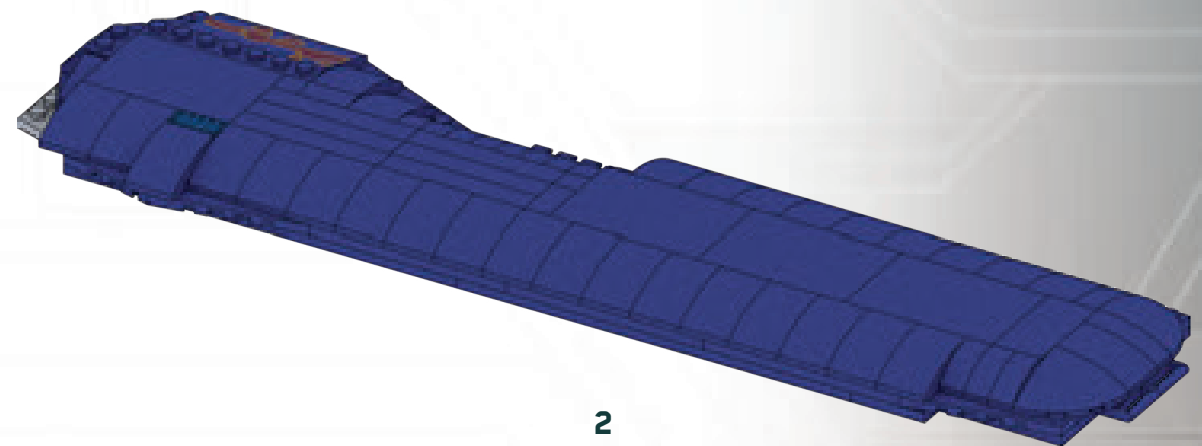
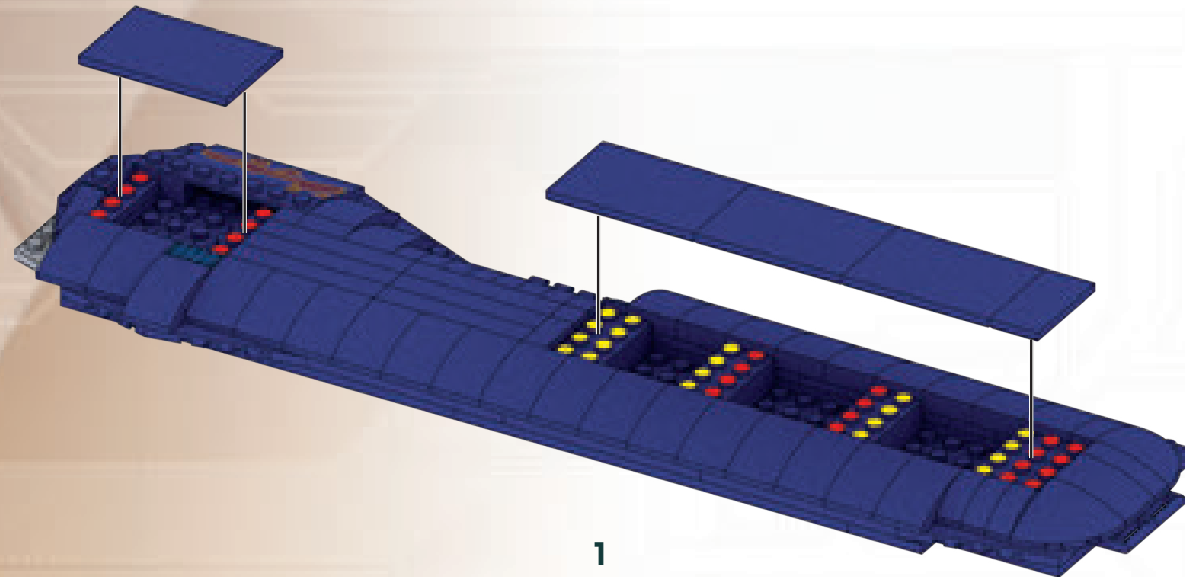
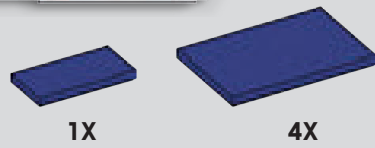

41



6X 2X

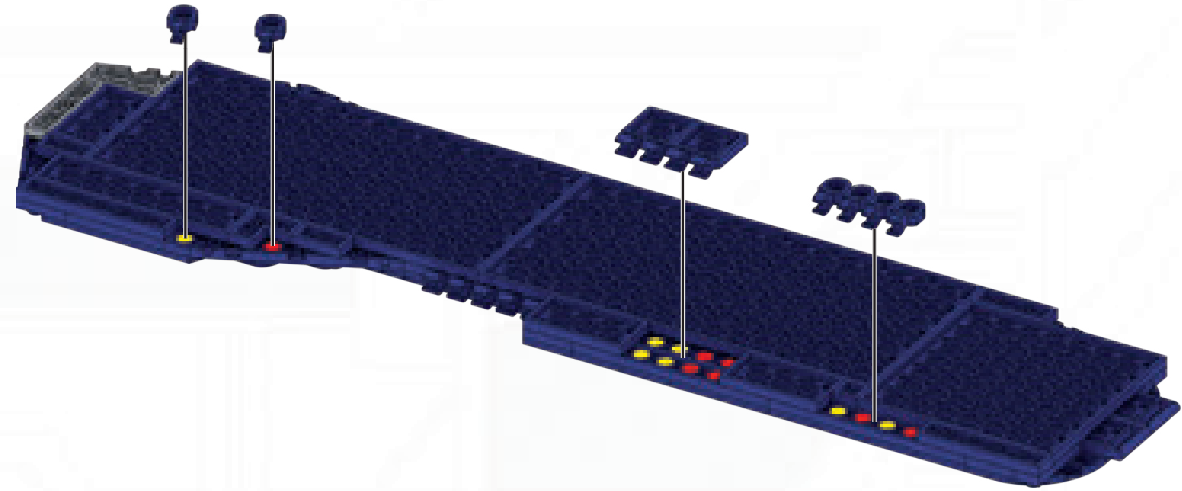

42

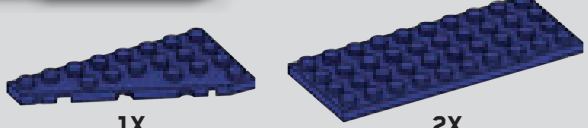

1X 2X

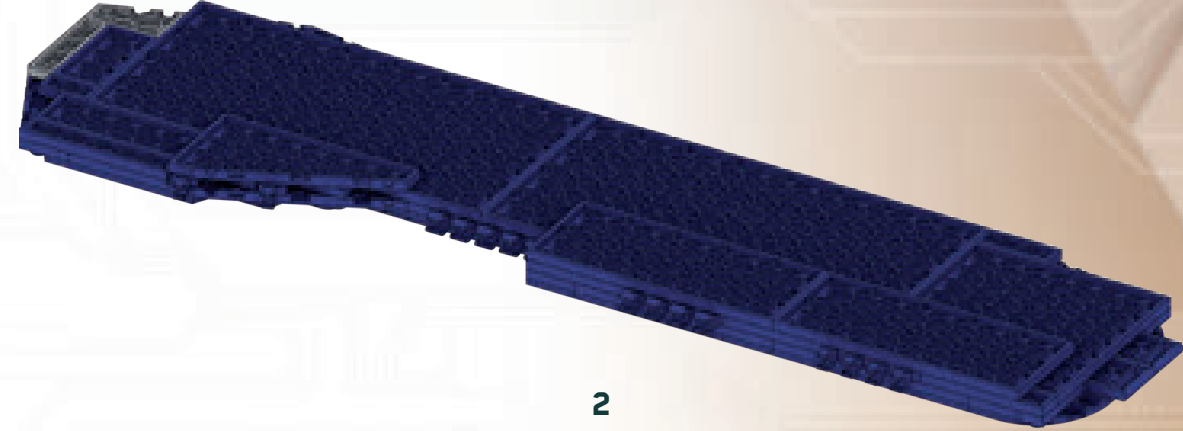
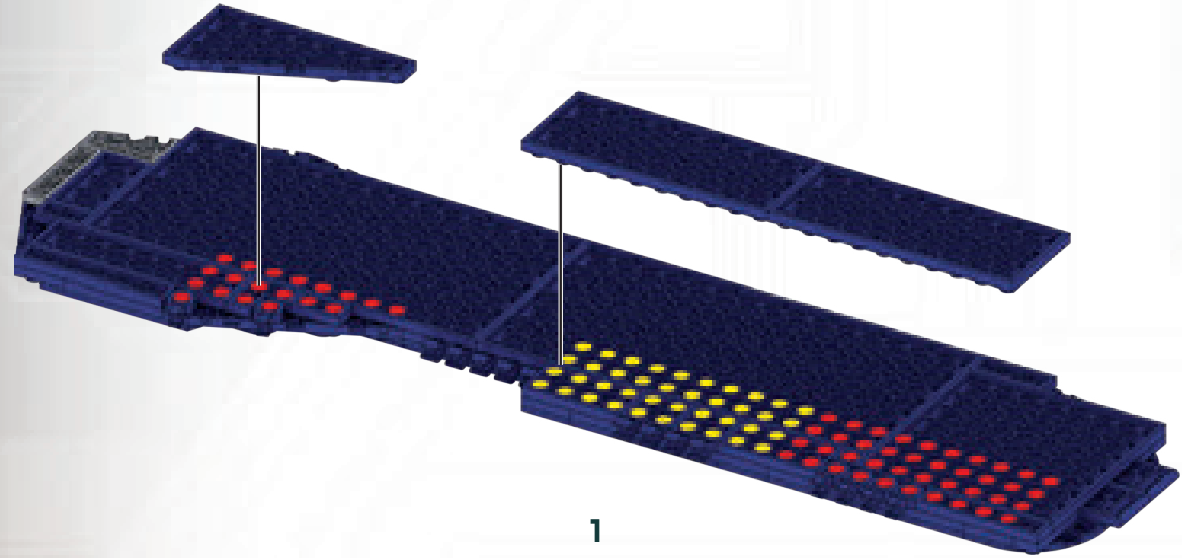

42

21

4

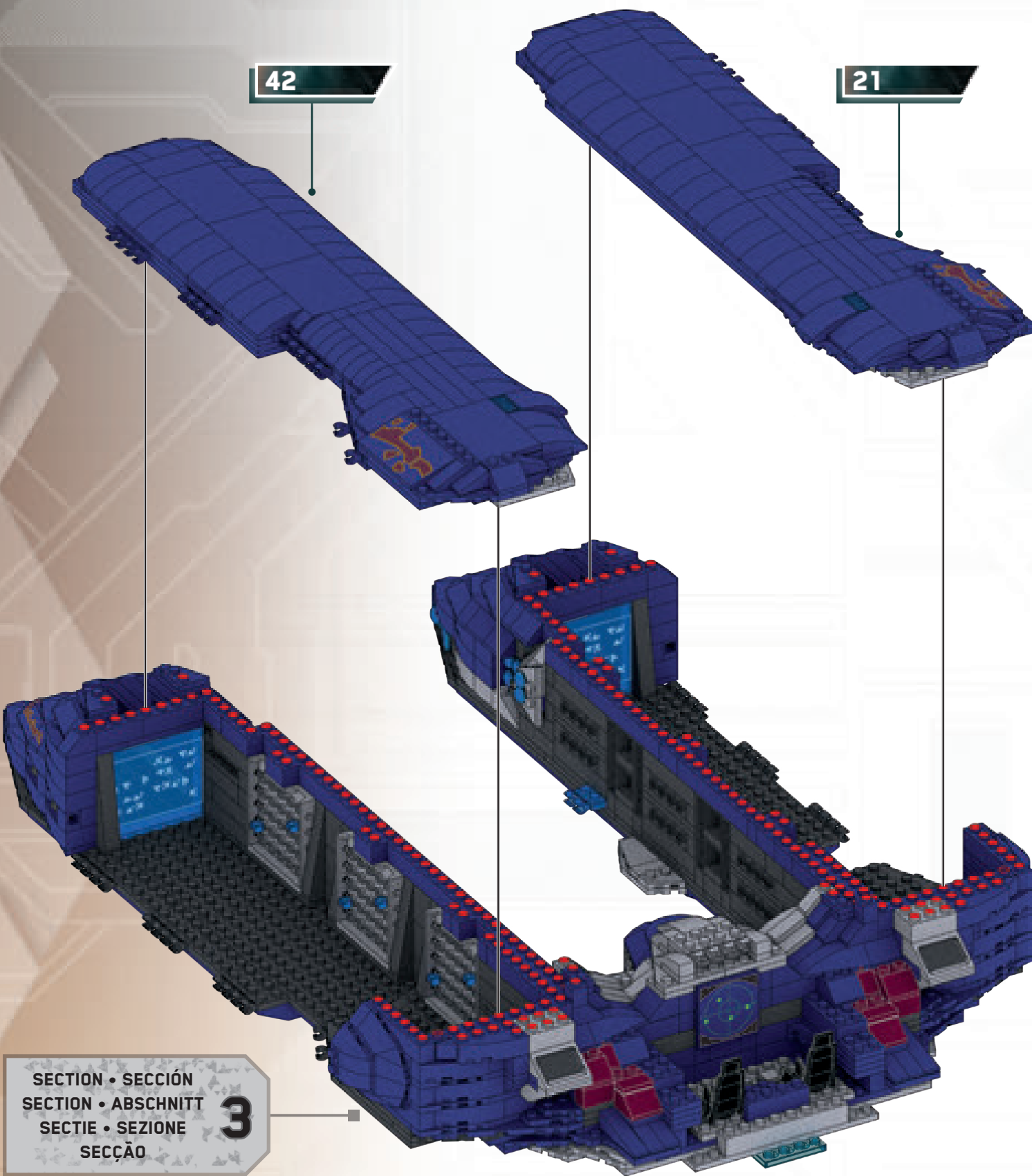

SECTION • SECCIÓN
 SECTION • ABSCHNITT
 SECTIE • SEZIONE
 SECCÃO

3

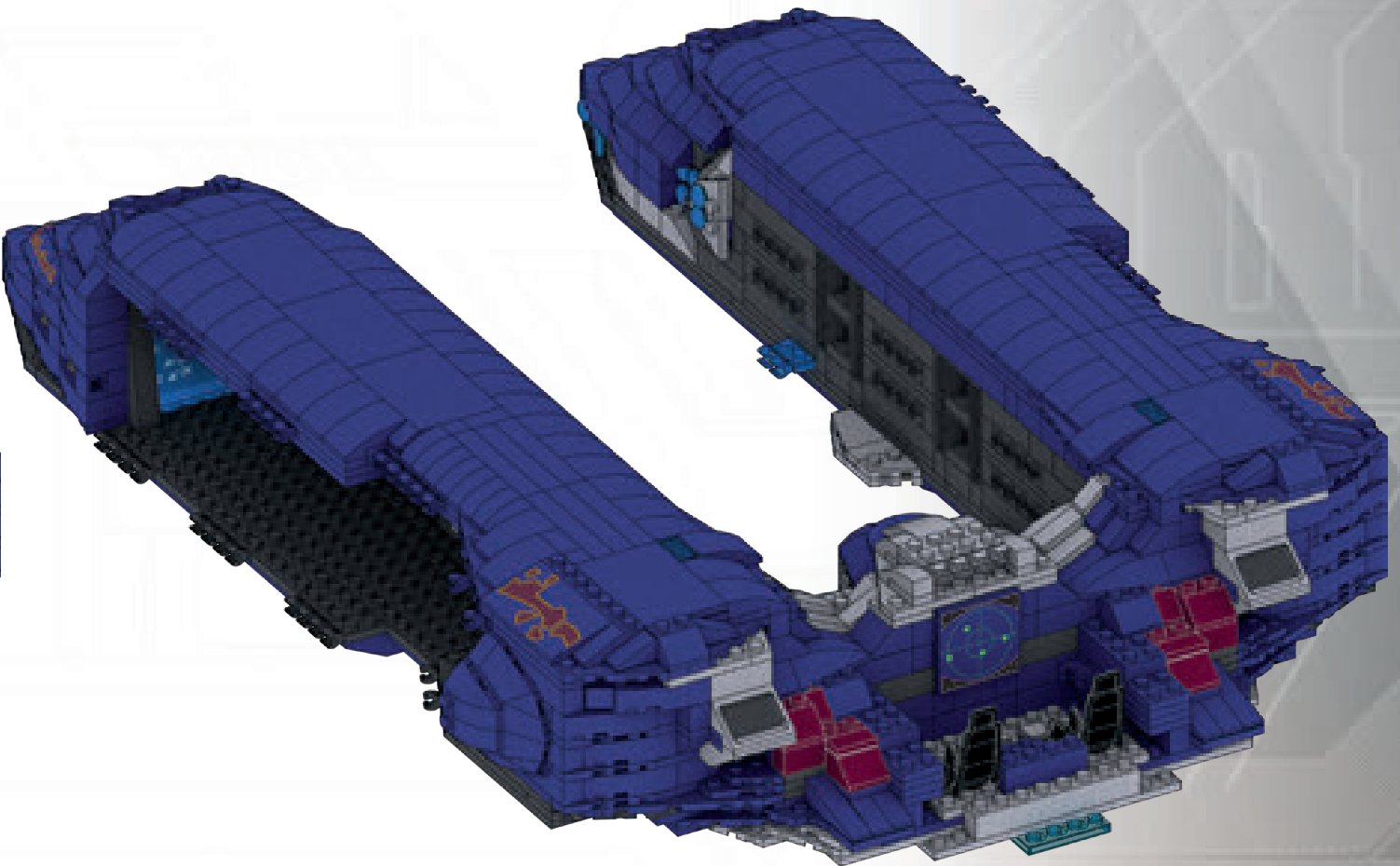

2

1

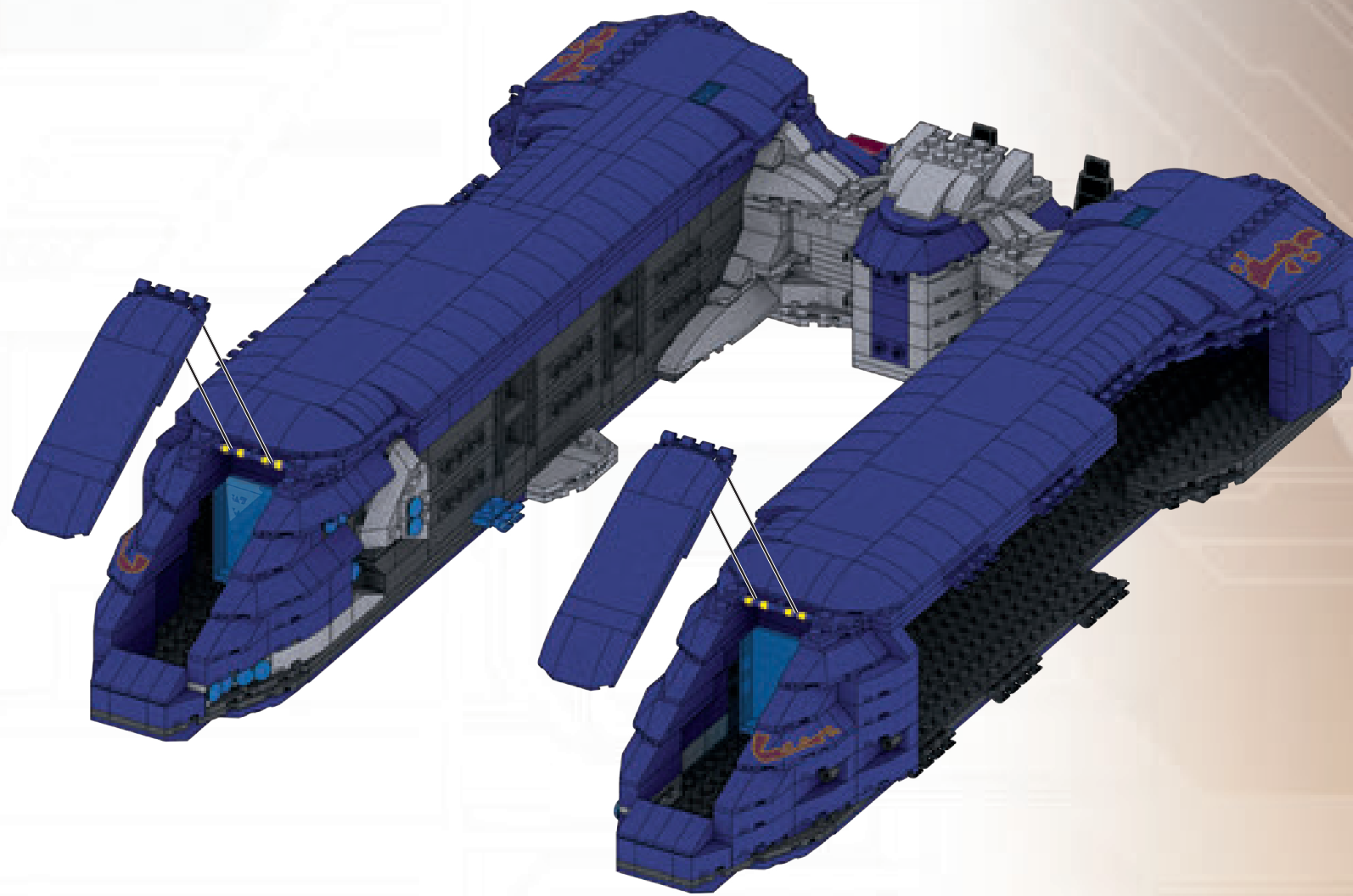
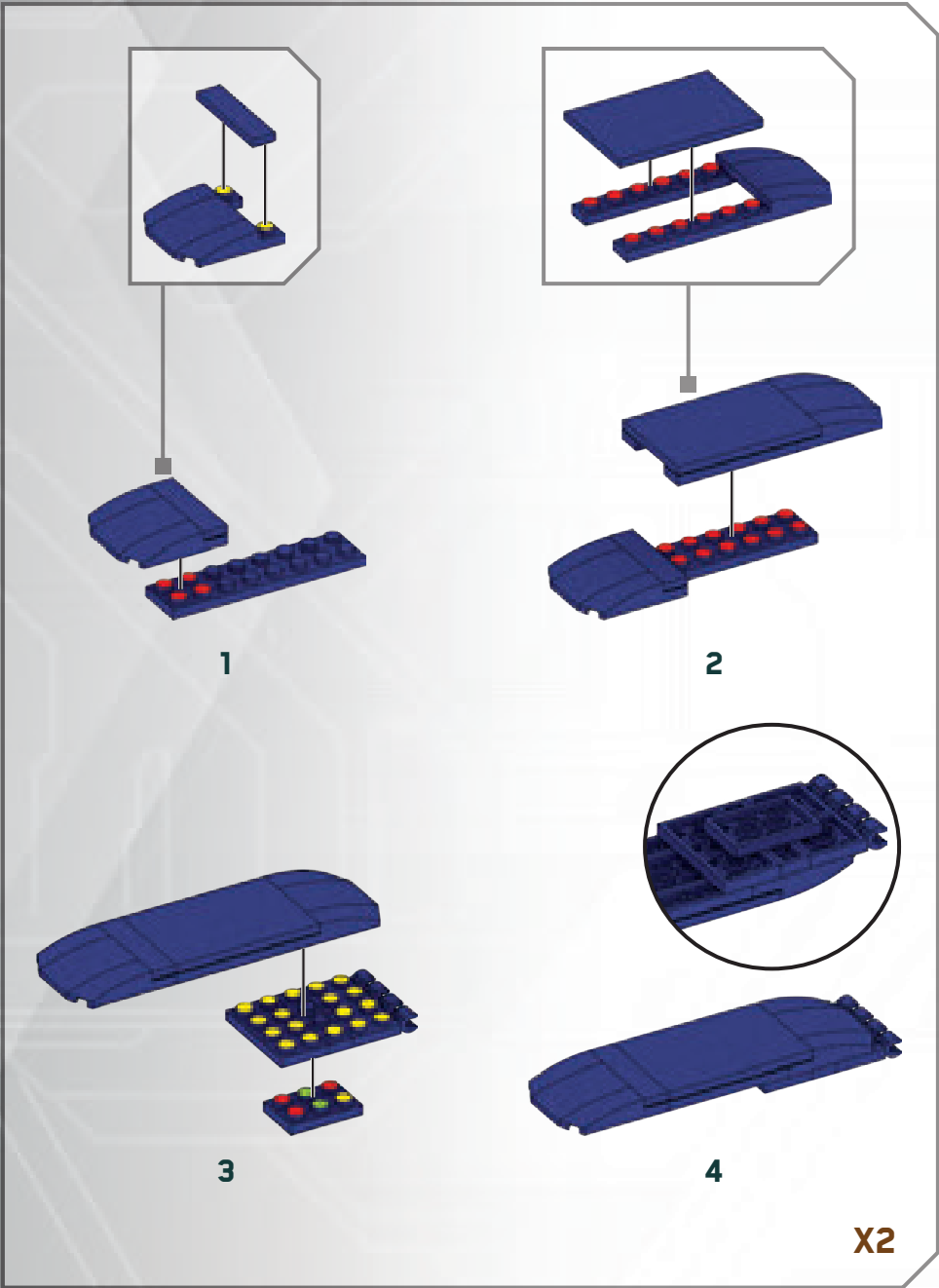
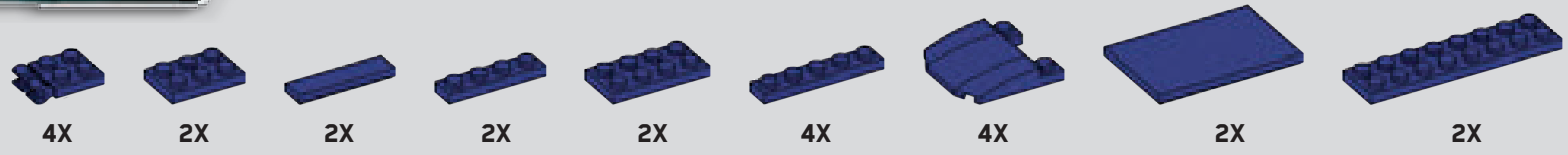

45

2X 1X 2X

46

2X 8X 1X

47

2X 6X 1X

48

3X 6X 2X

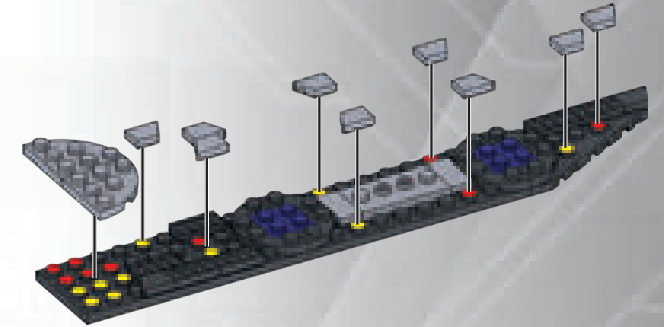
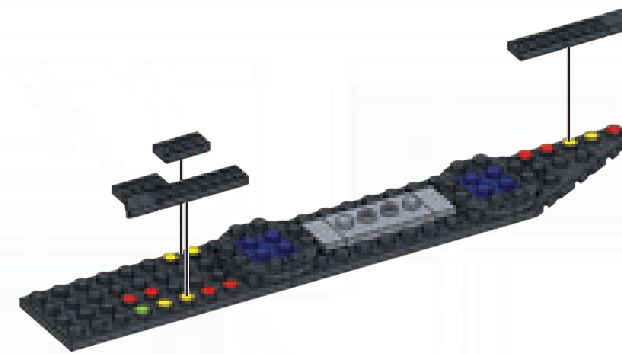
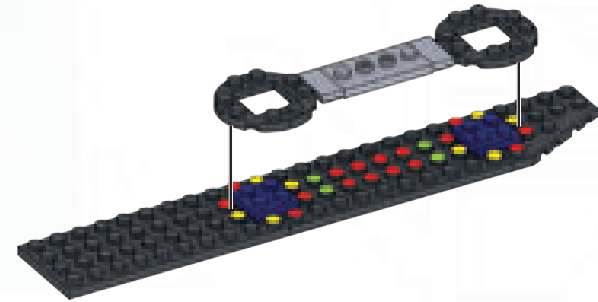
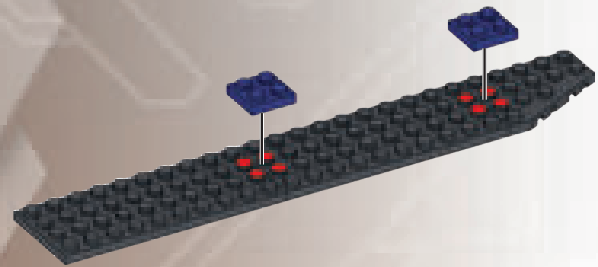

49

15X

50

4X 1X 1X 1X 1X 3X

51

3X

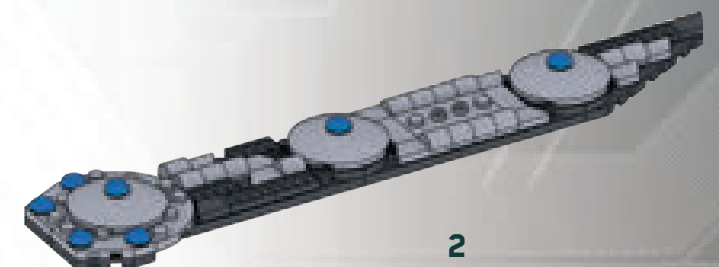
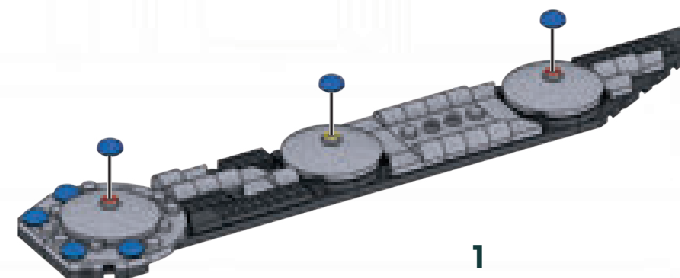
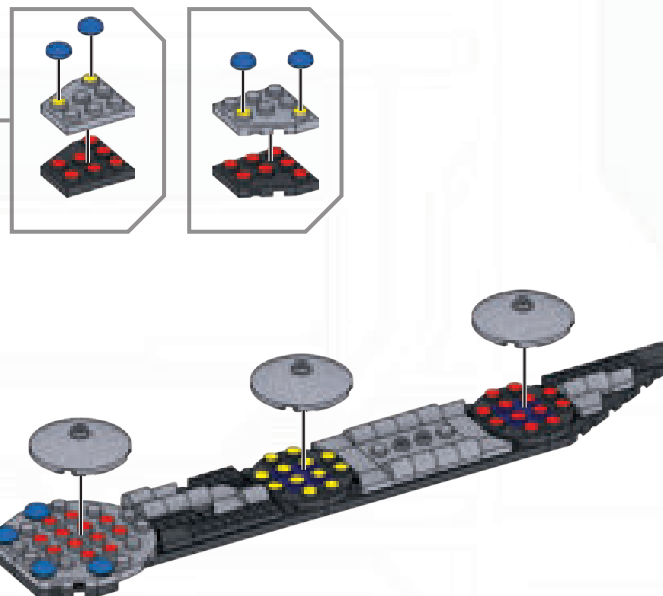
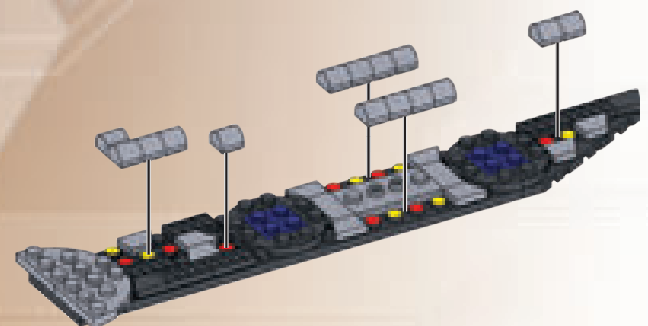

1

2

53

1X 1X 1X 1X 1X

1 2

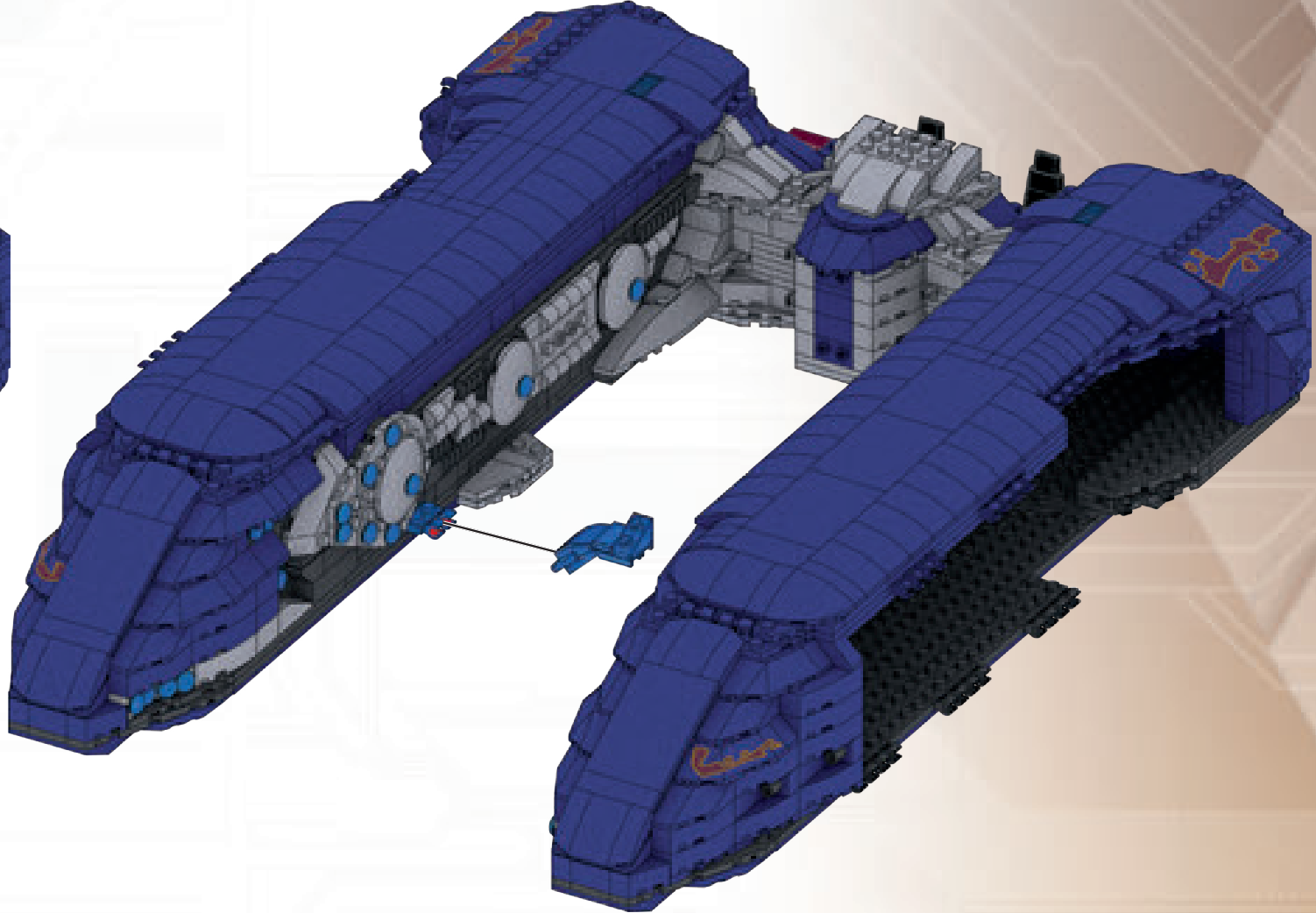
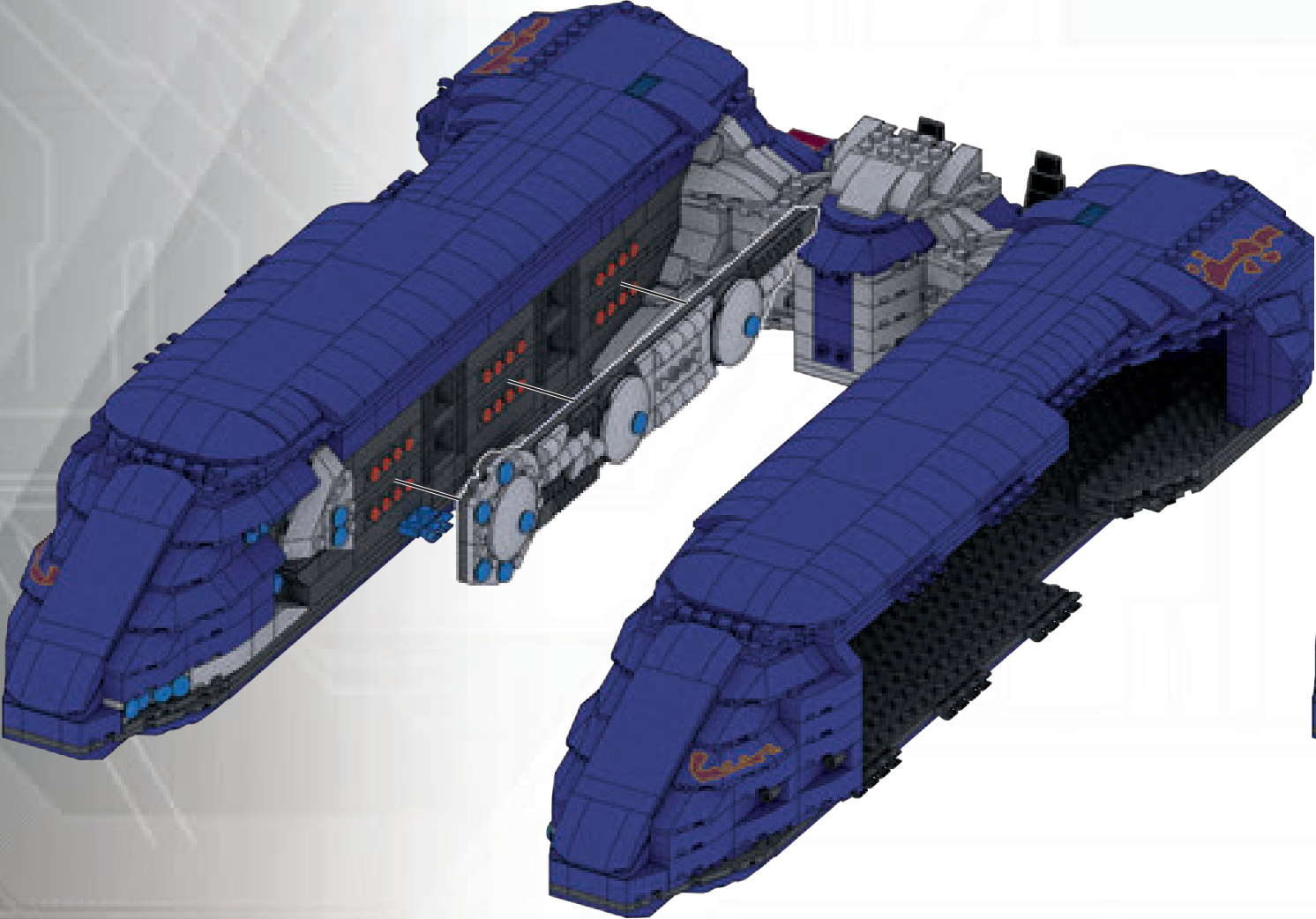
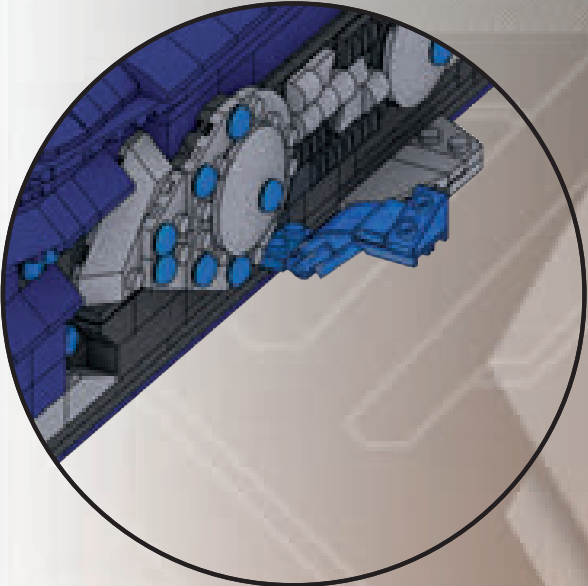

54

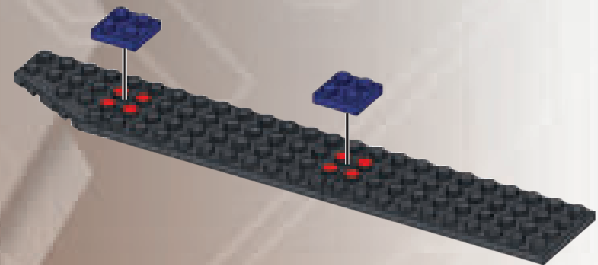

55

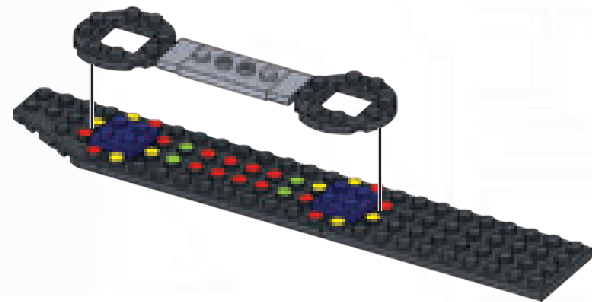

56

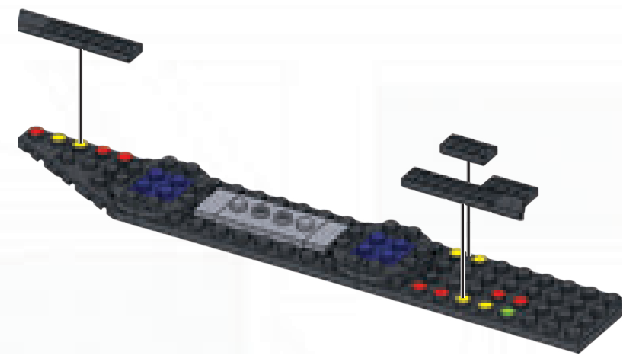

57

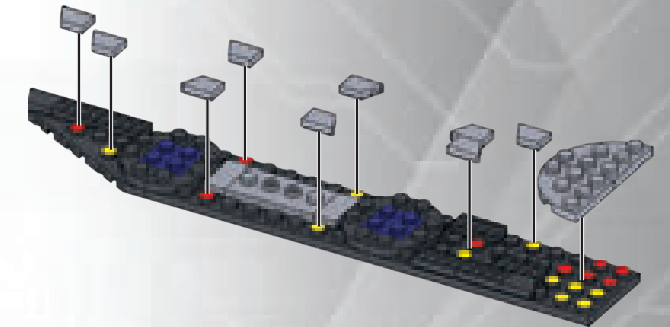

58

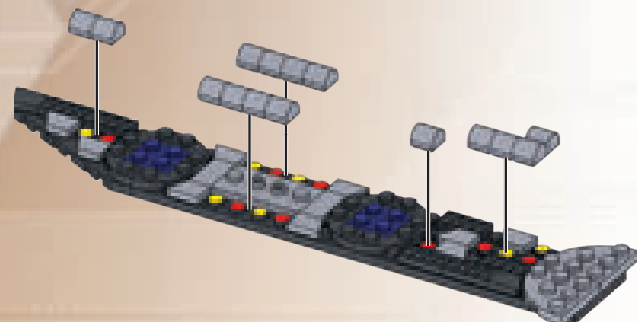

59

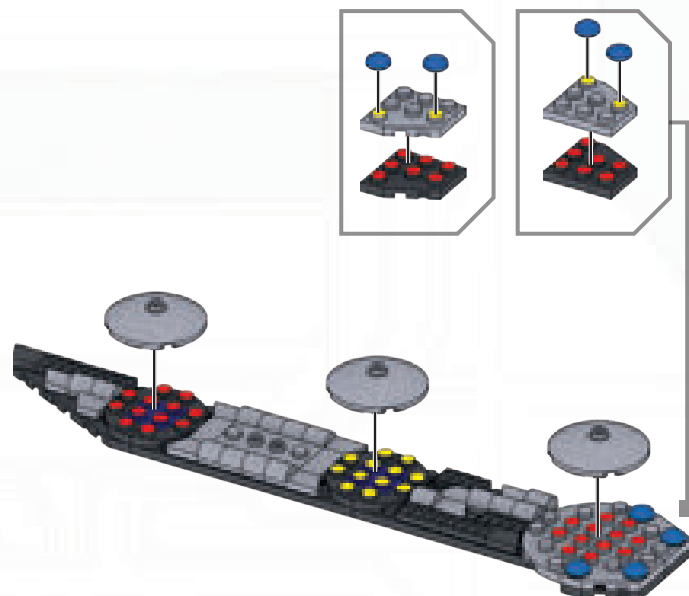

60

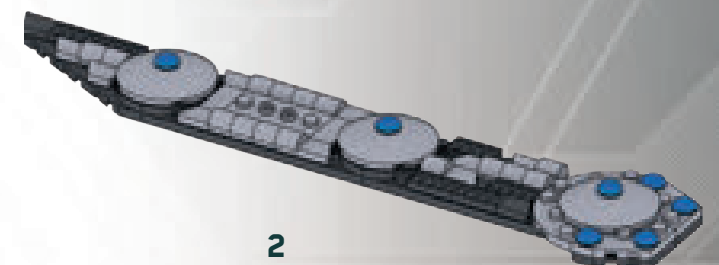
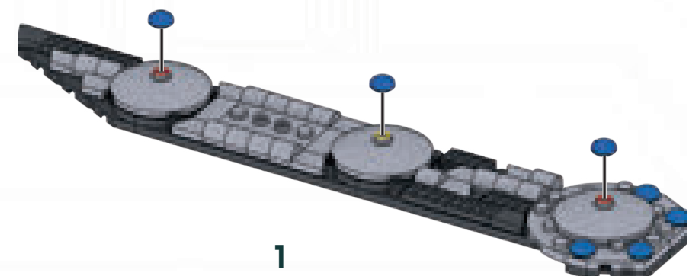

1

2

62

1X	1X	1X	1X	1X

1

2

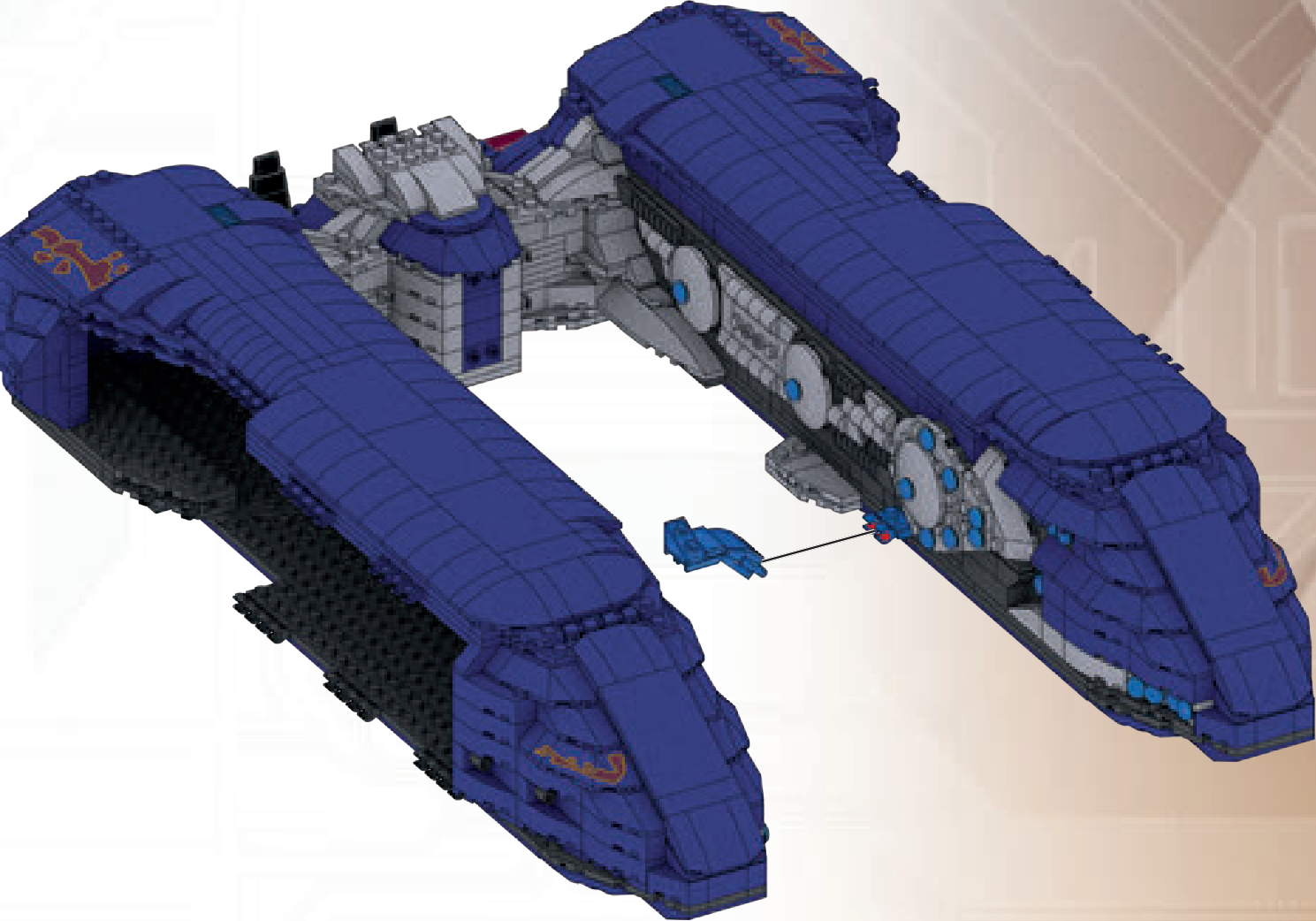
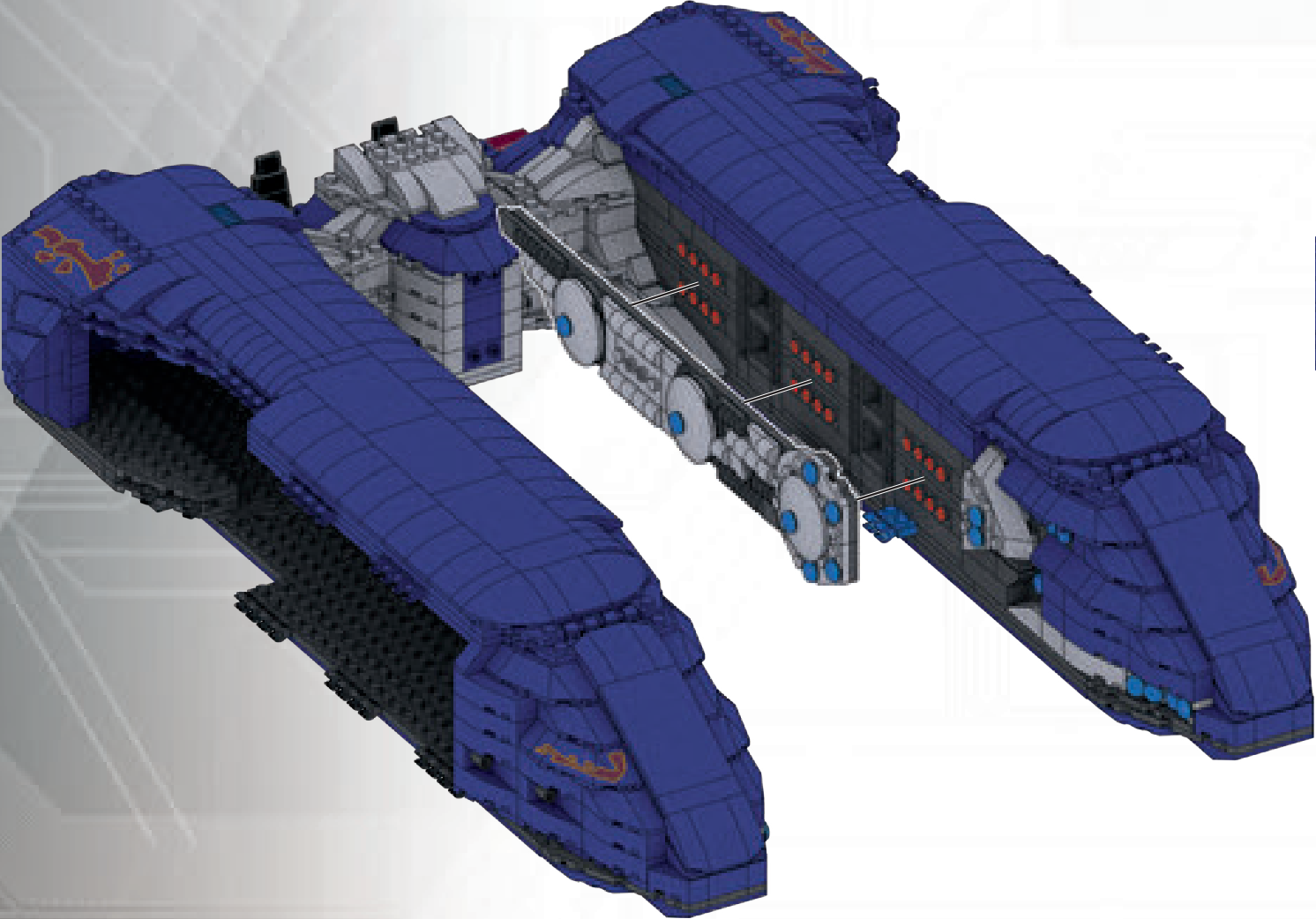
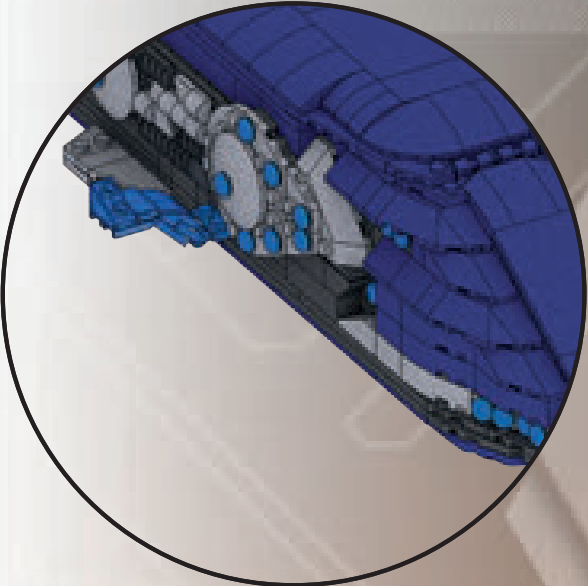

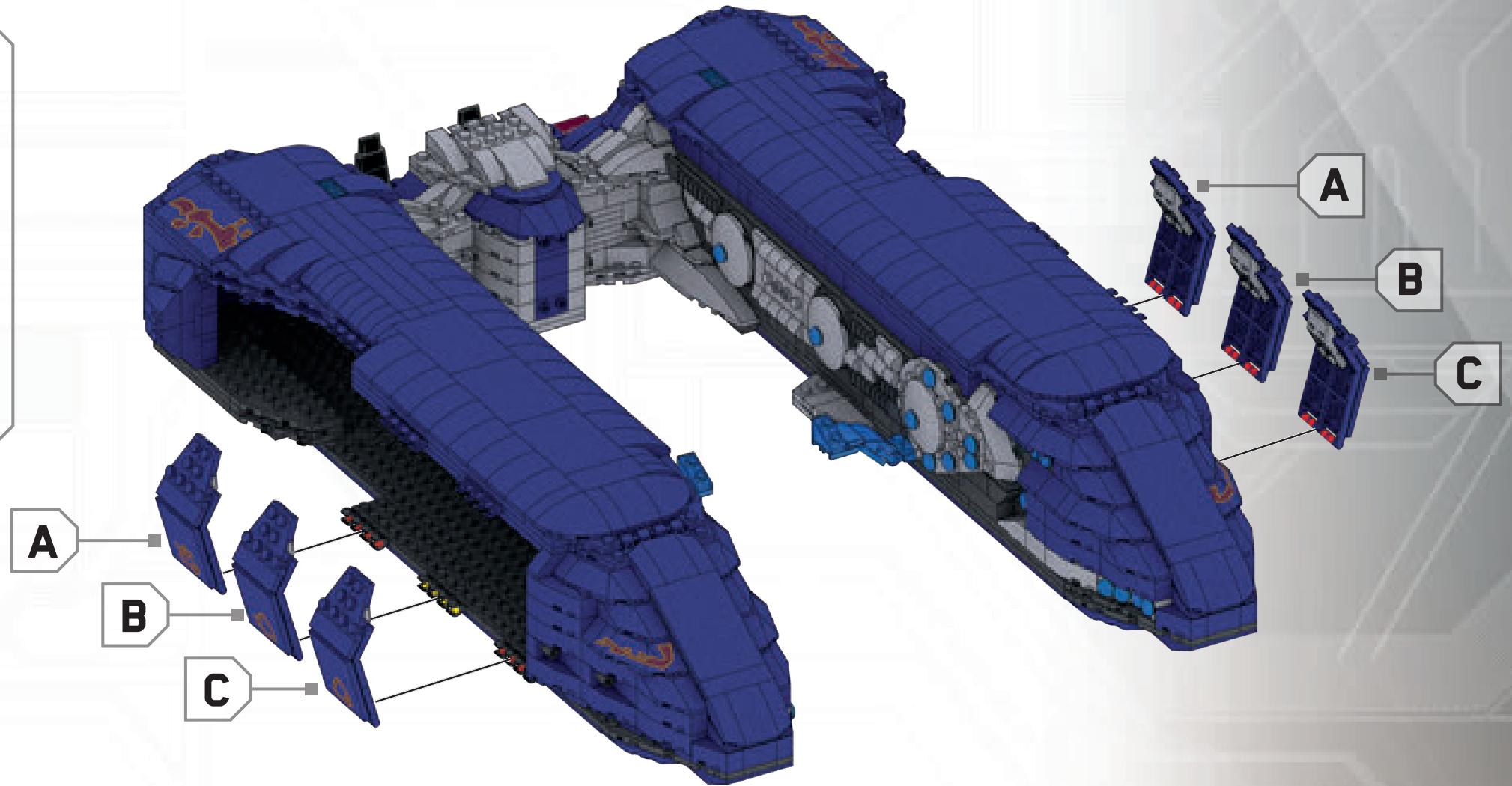
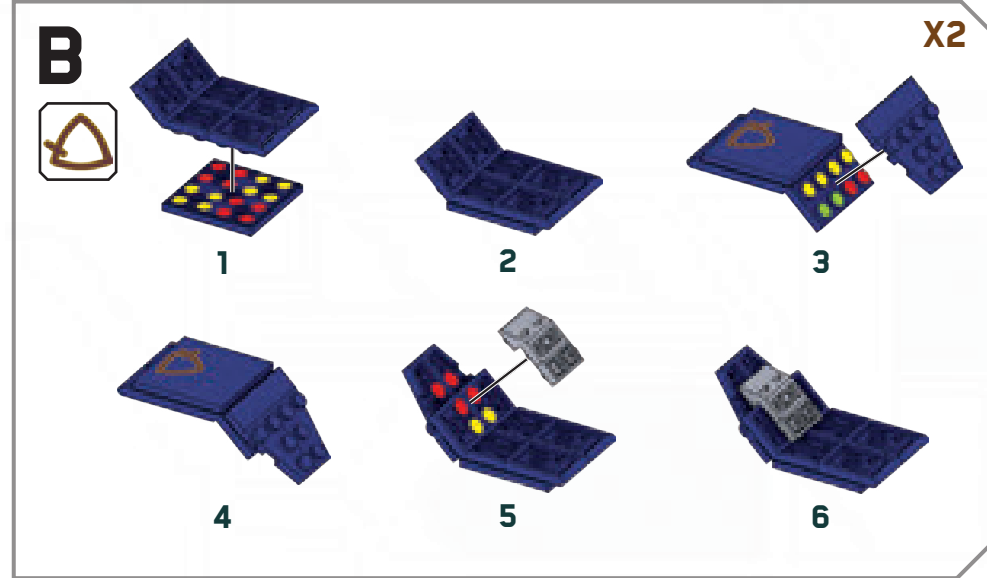
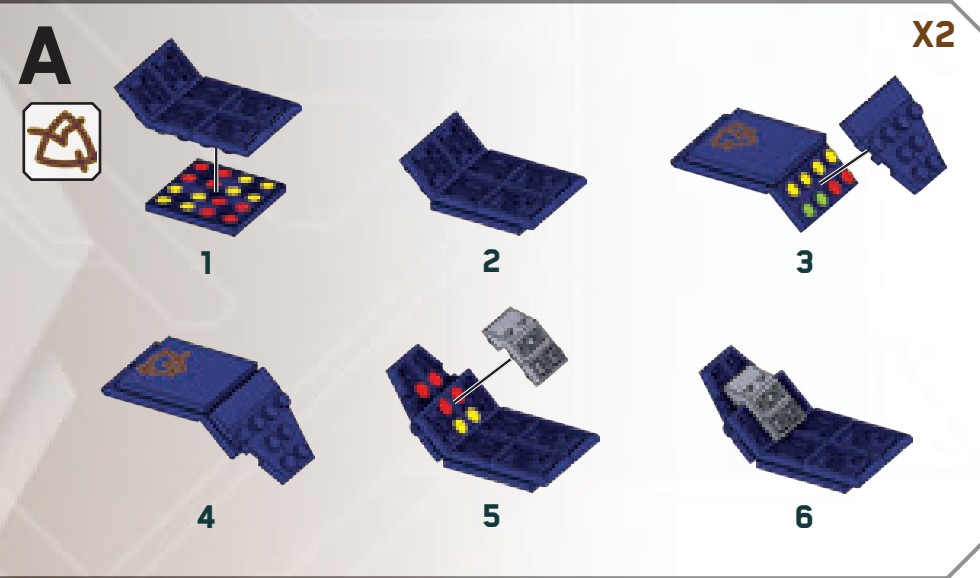
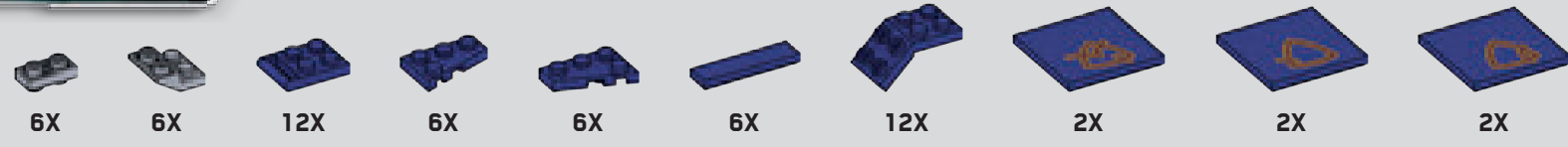

4

64

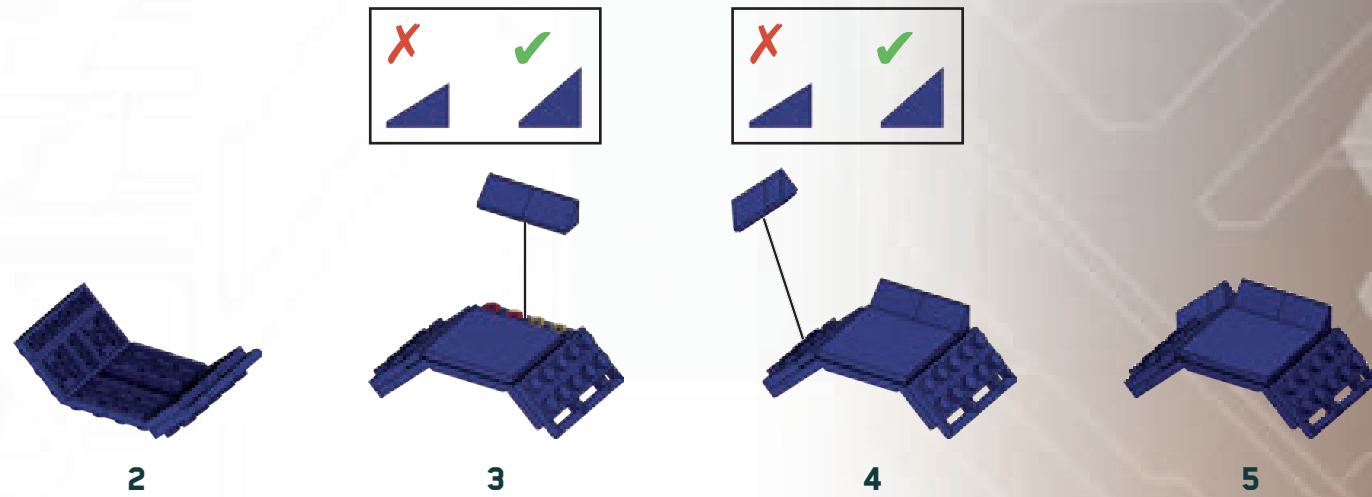
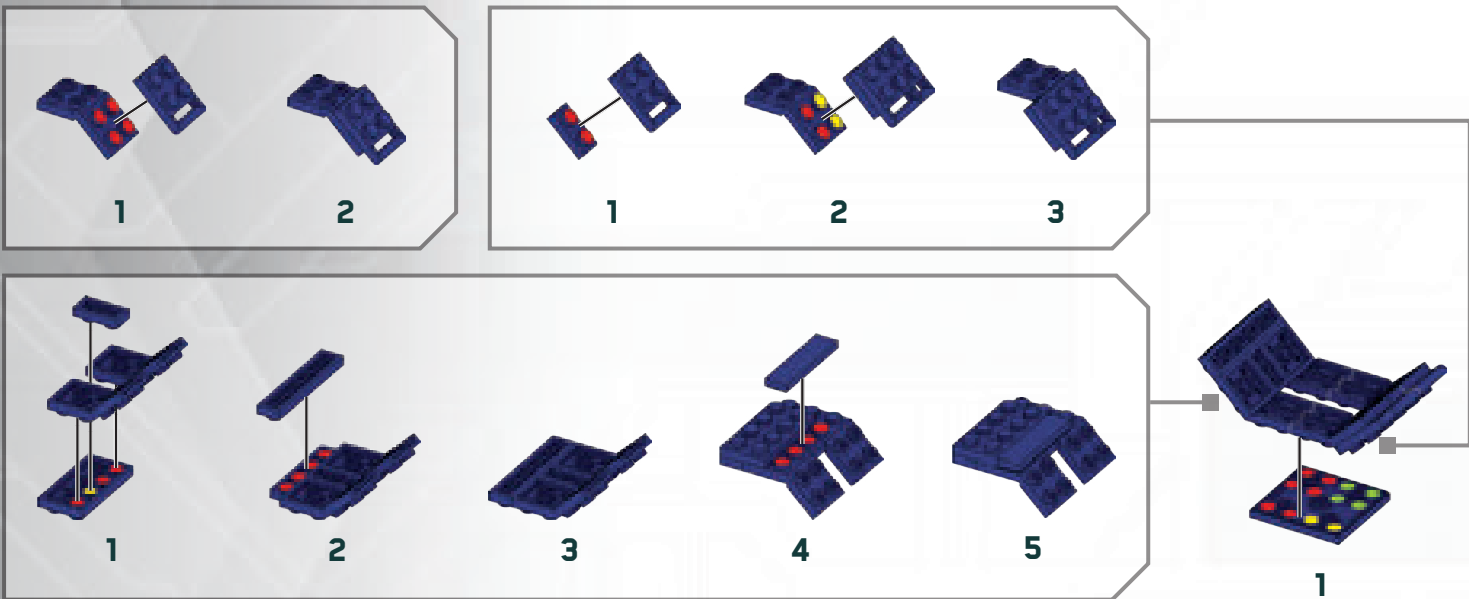
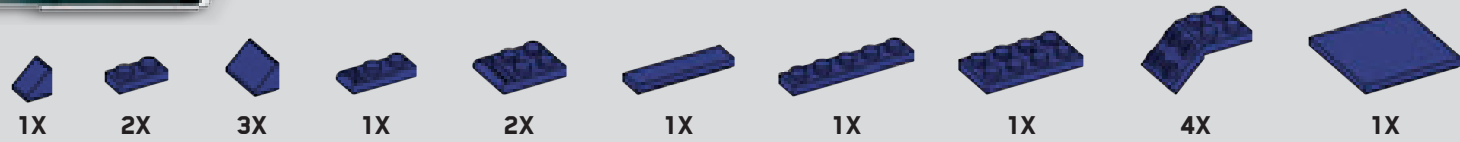

65

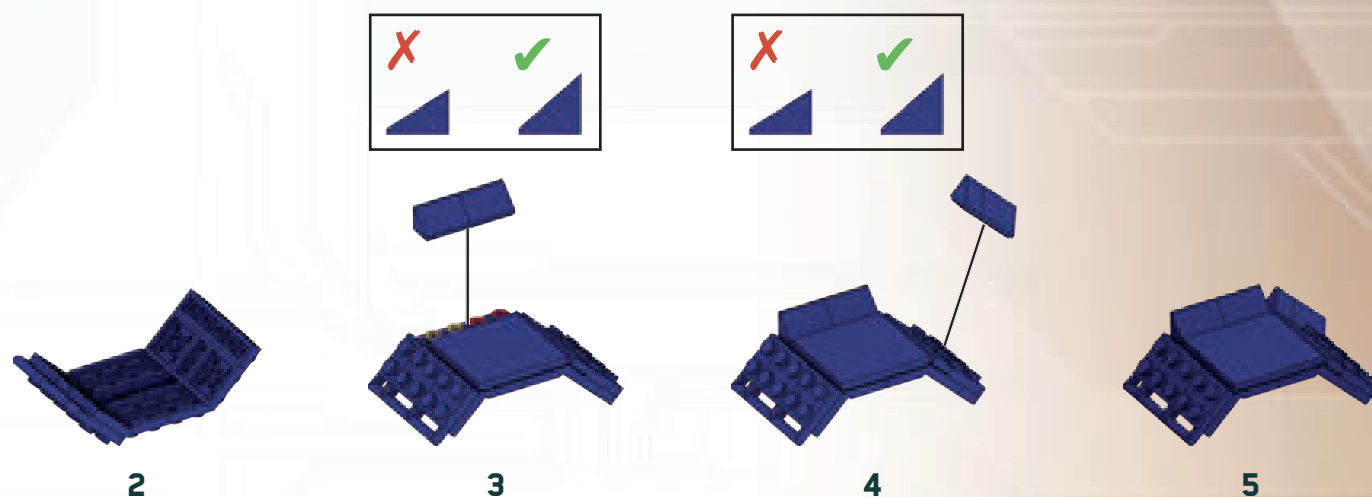
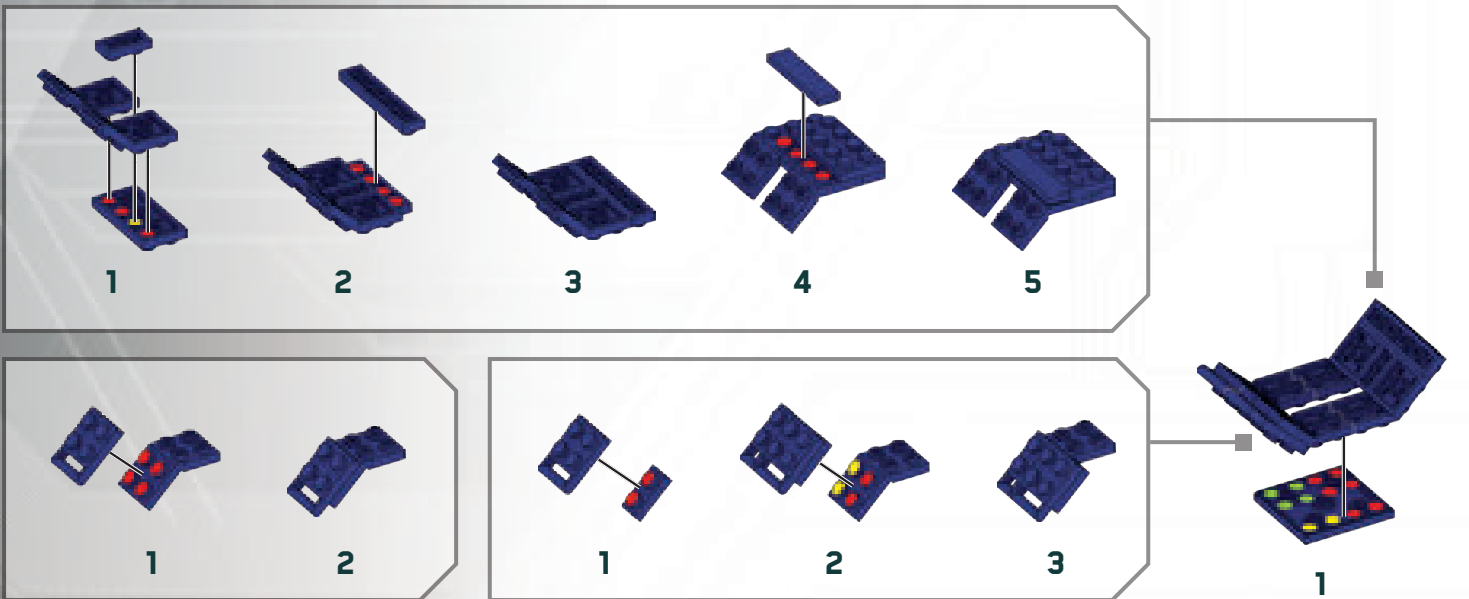
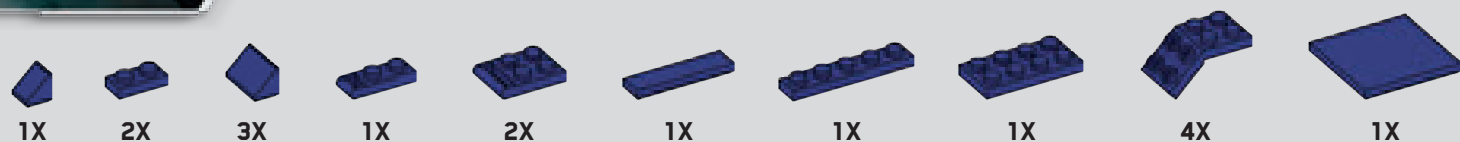

66



X4

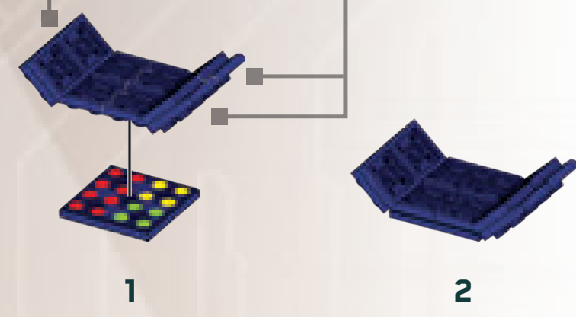
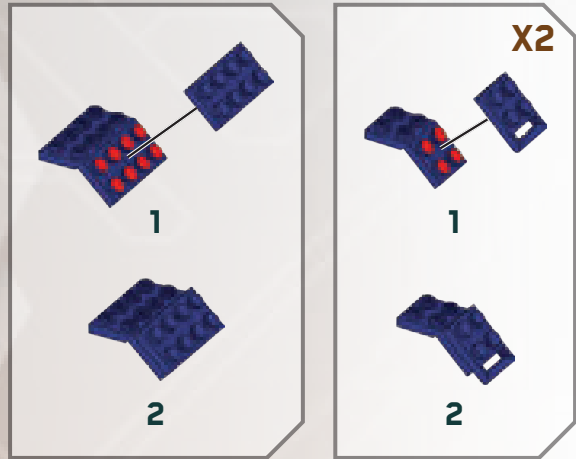

4

65

64

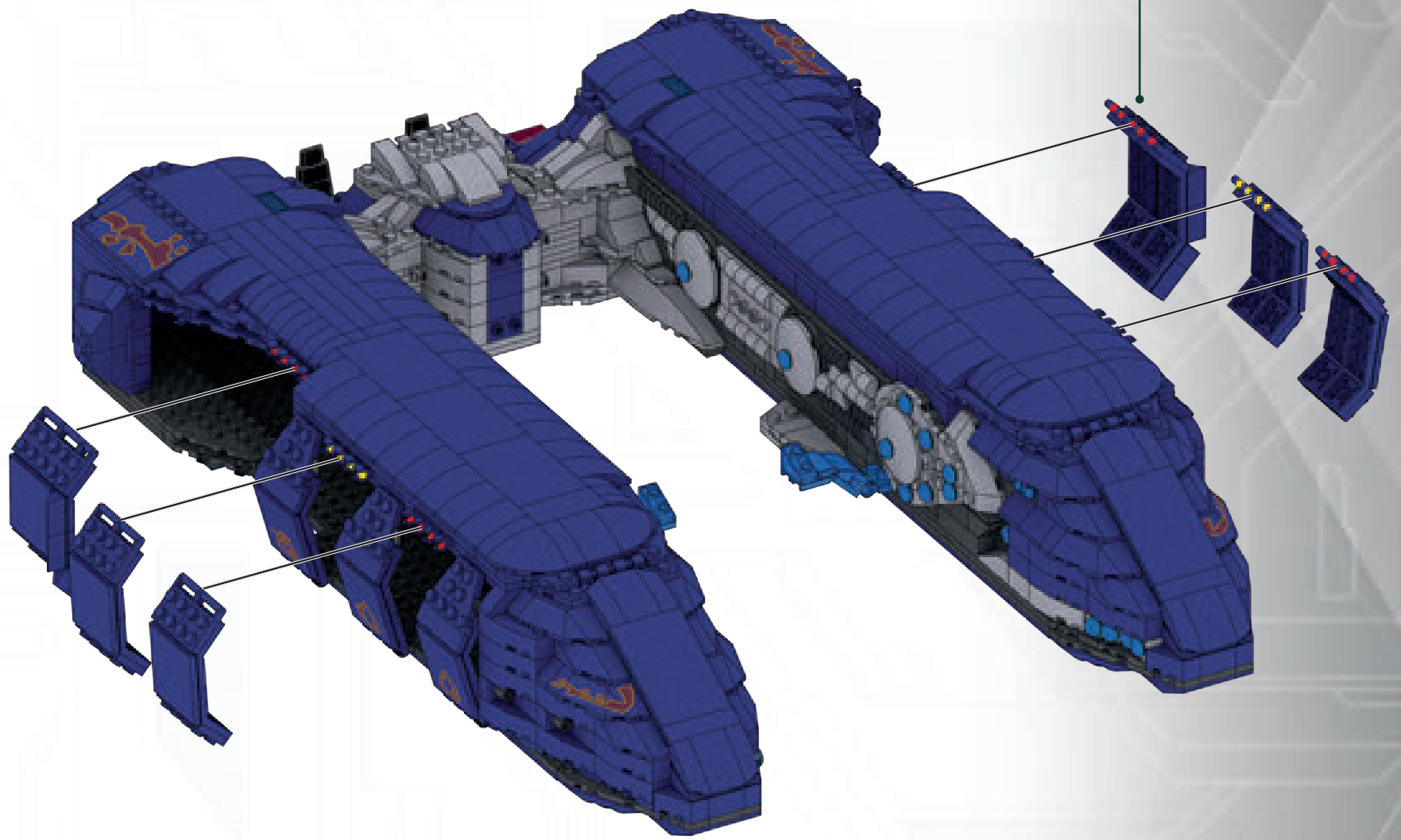

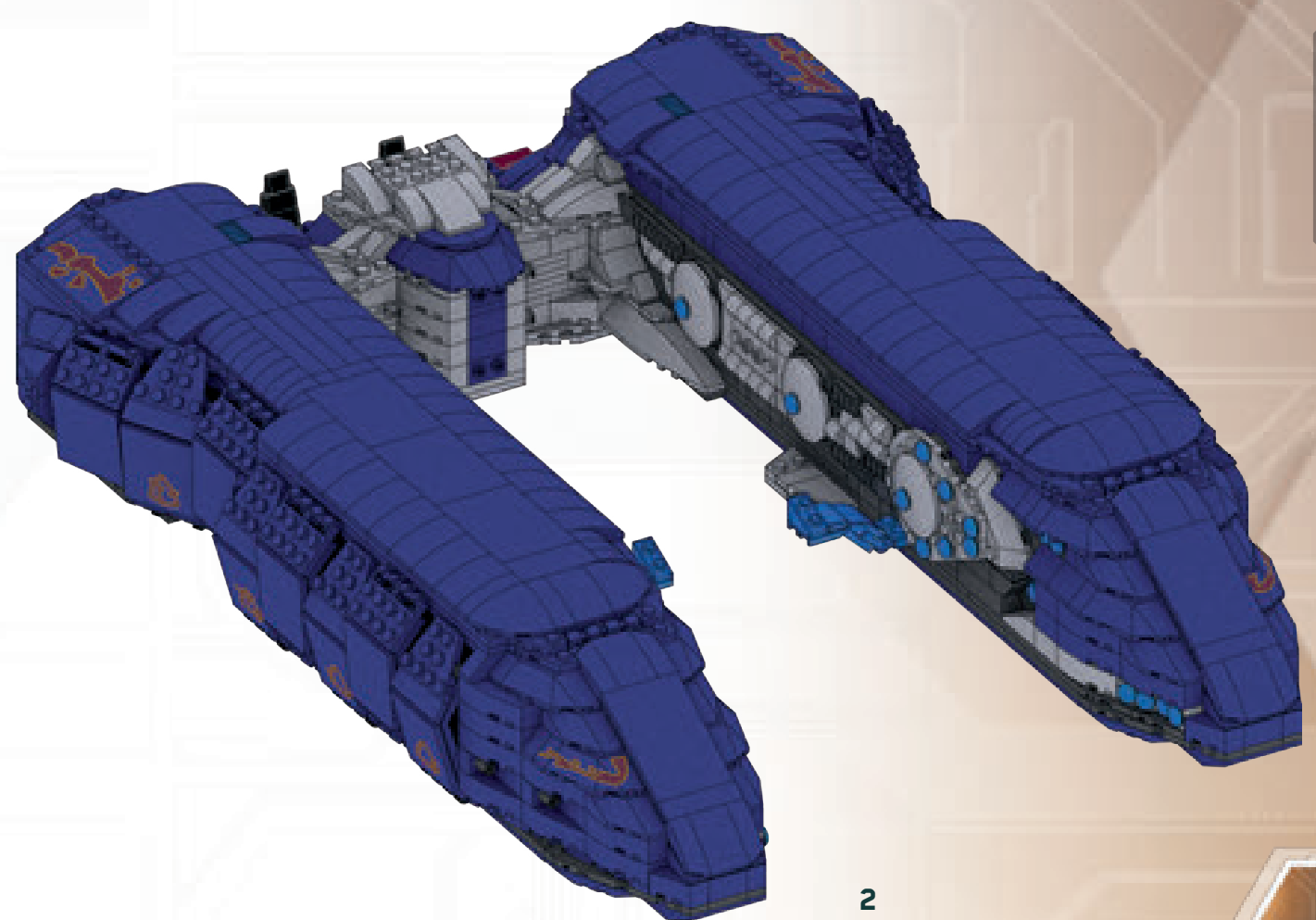
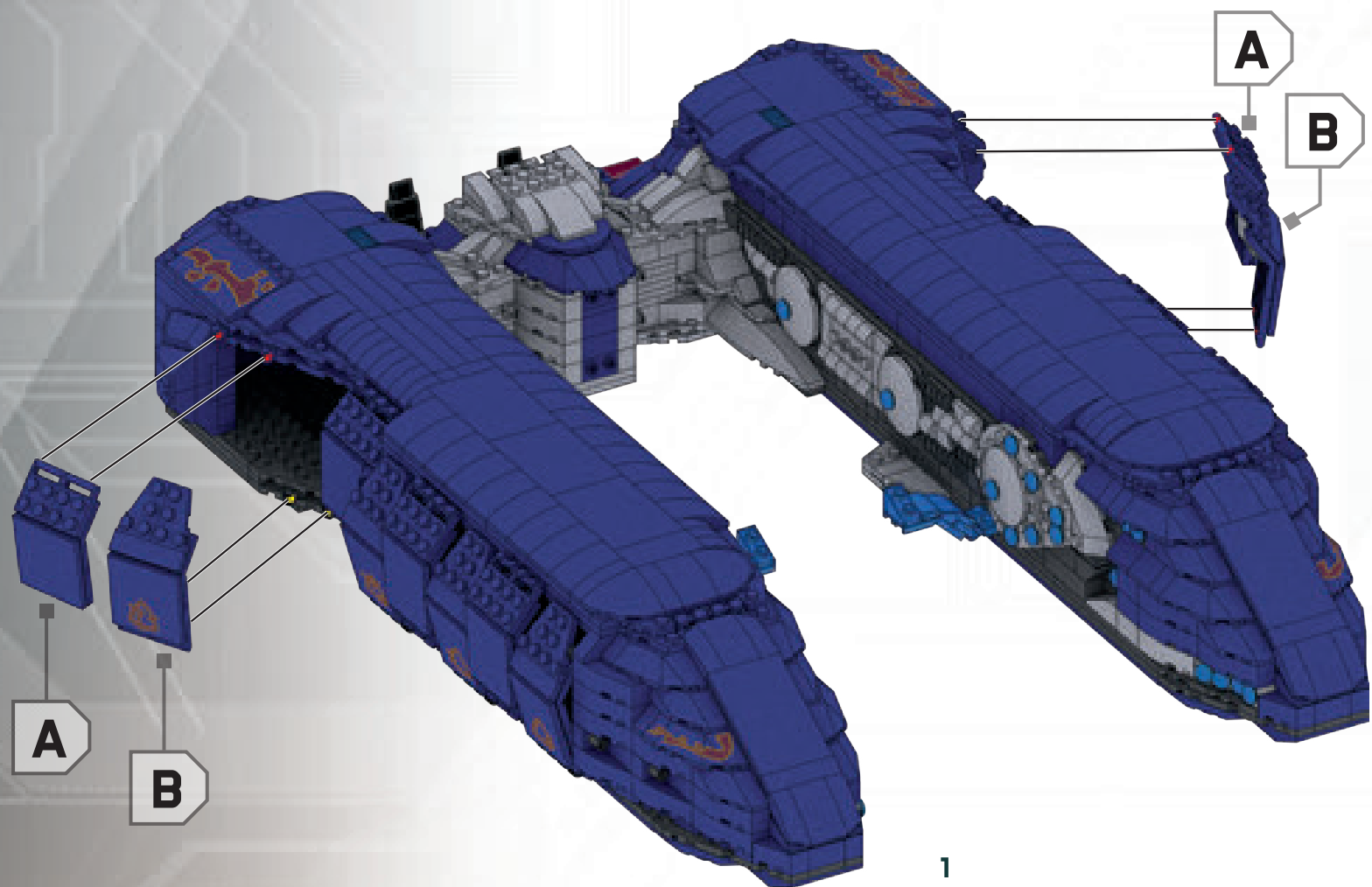
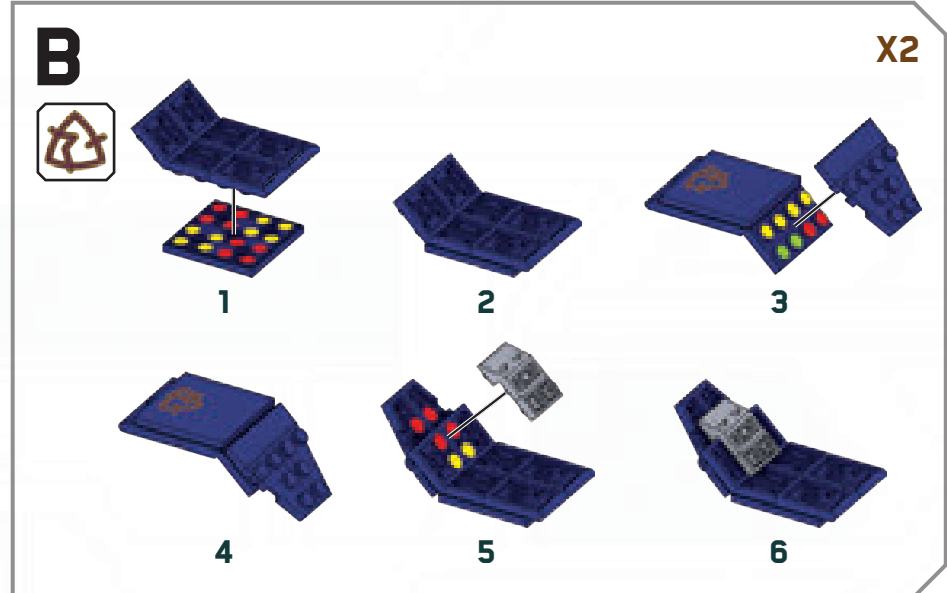
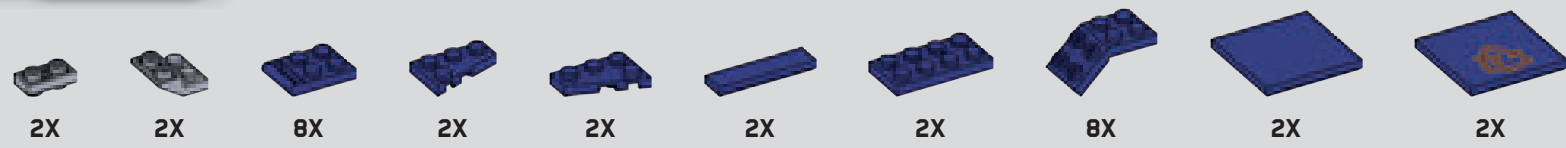

68

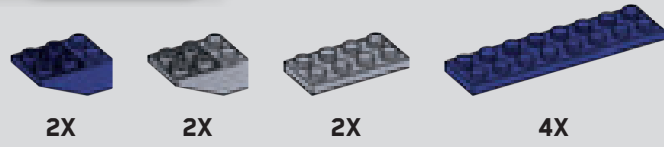

2X

2X

2X

4X

69



4X

2X

4

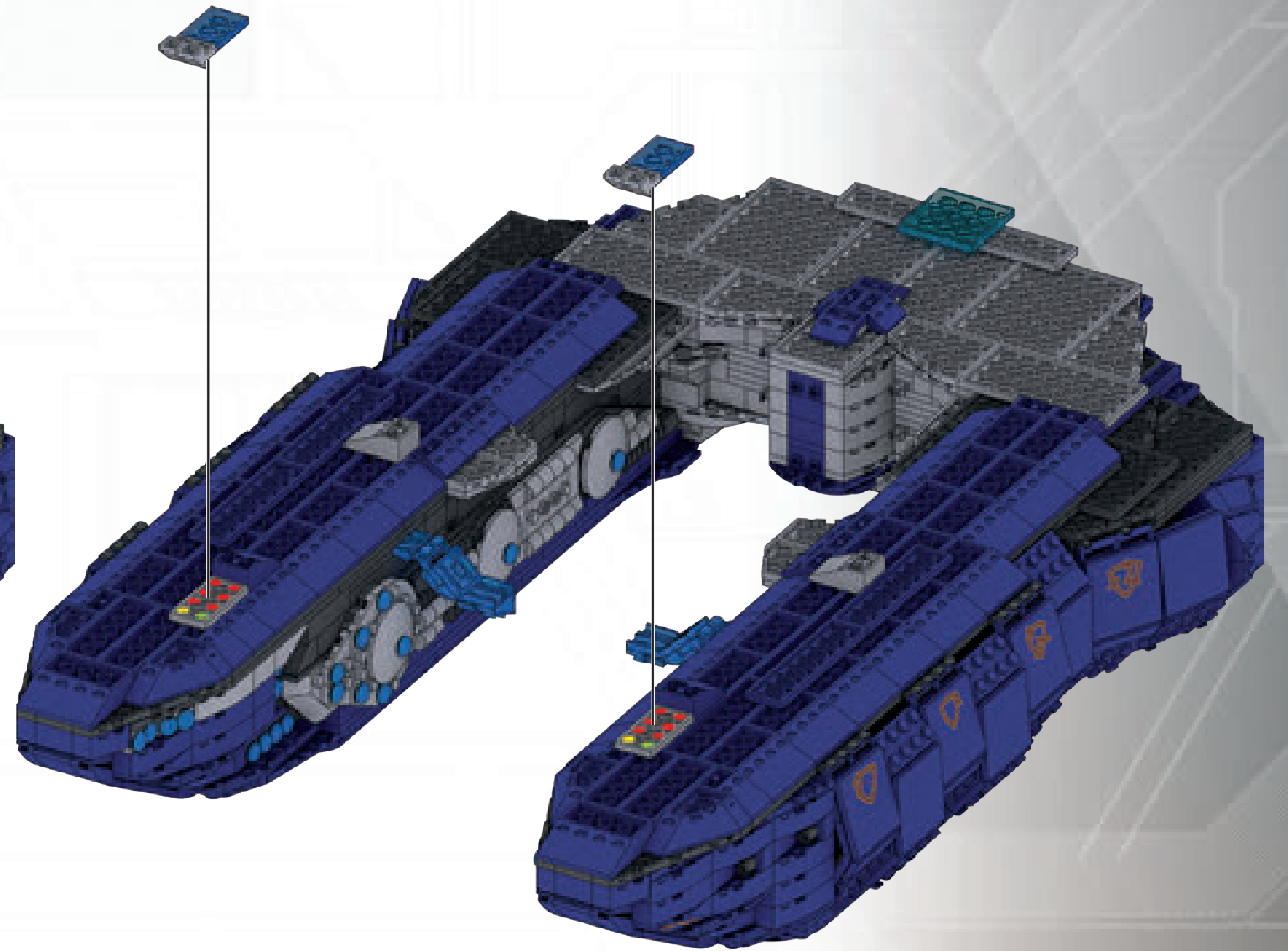
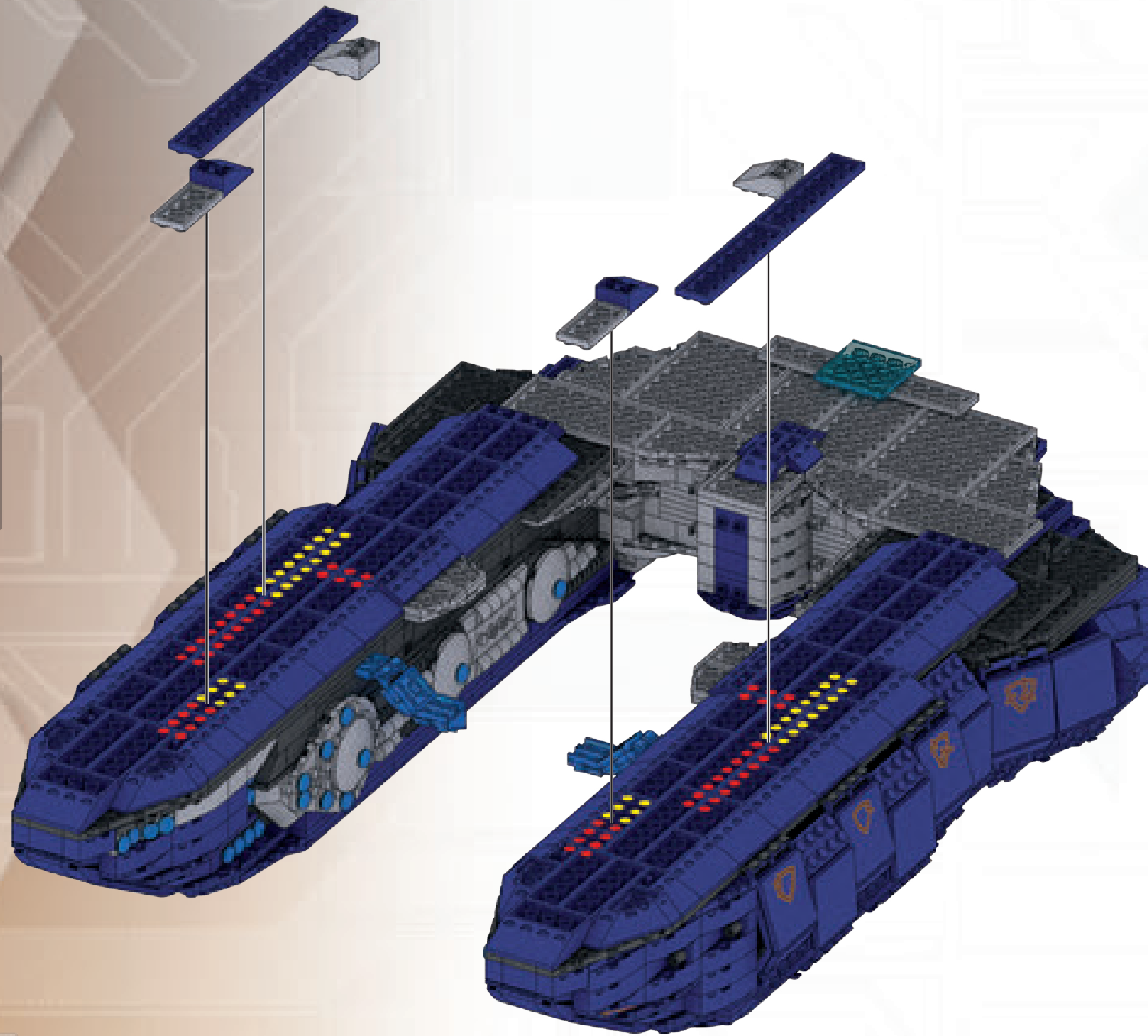

70



2X 2X

71



2X 2X

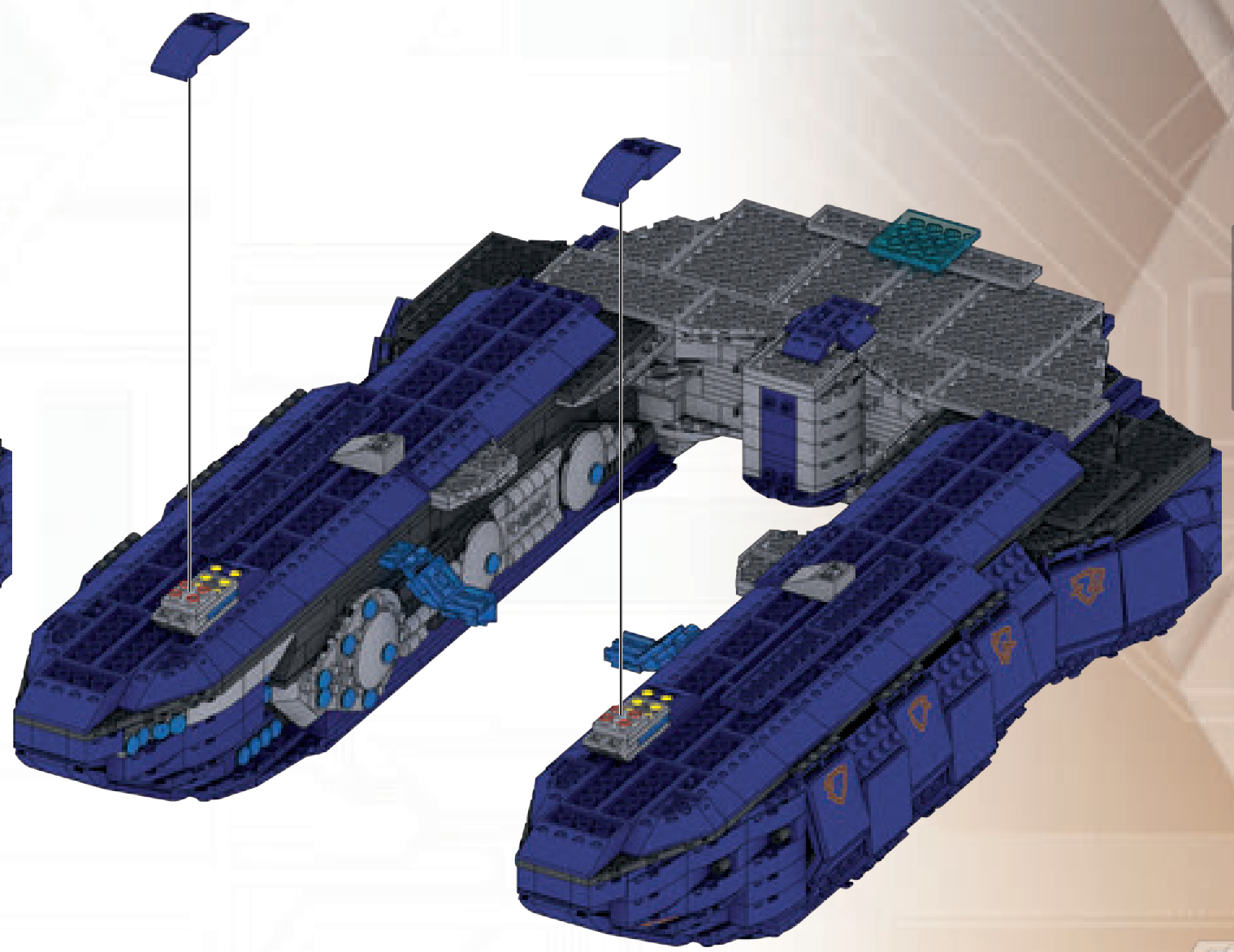
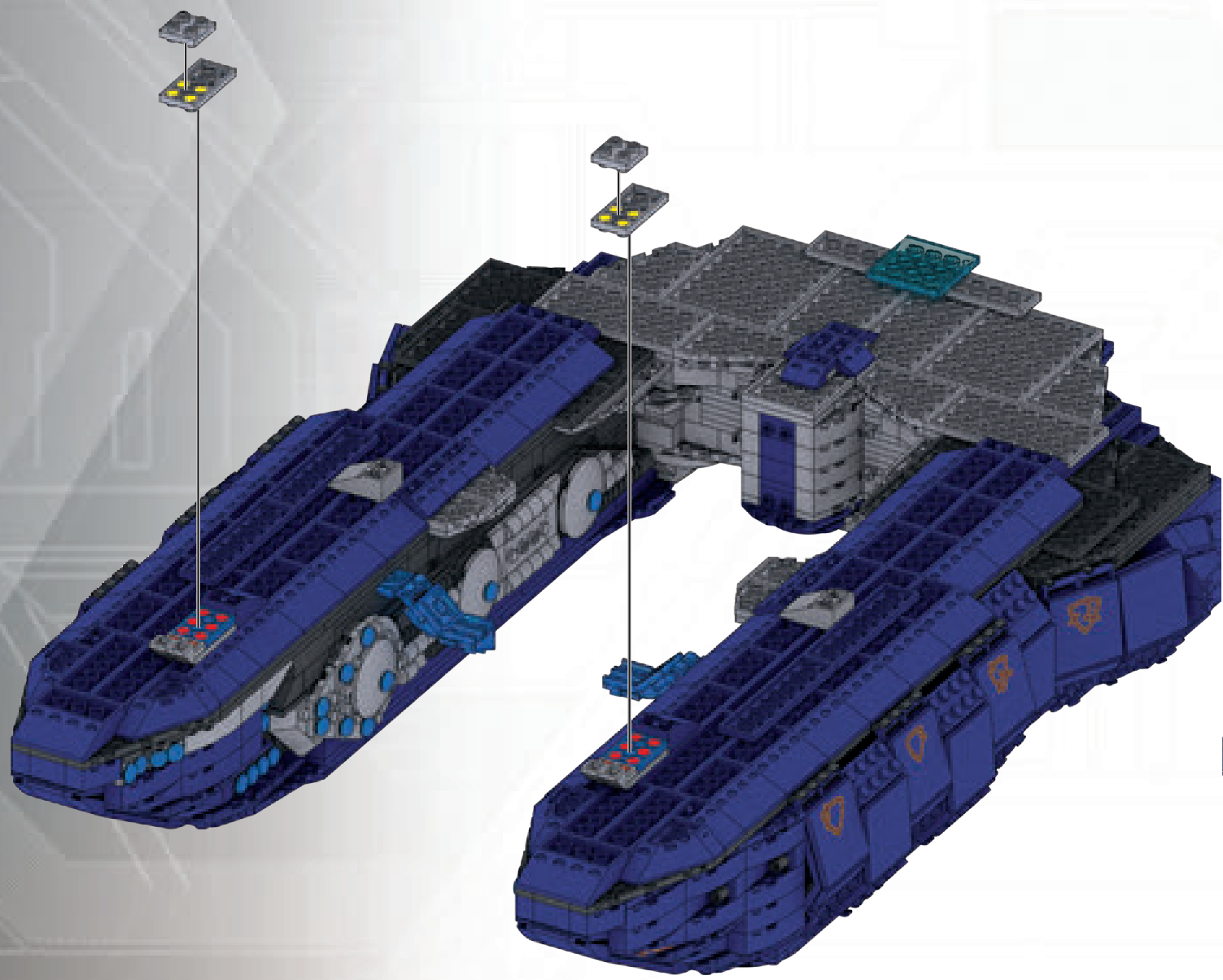

4

72



73

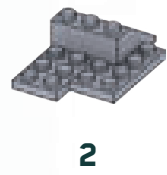
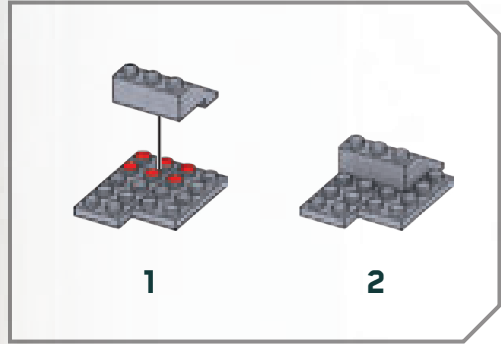
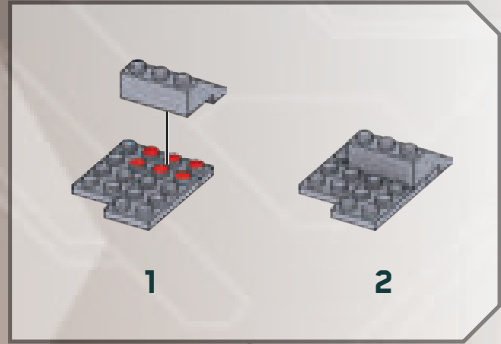

4

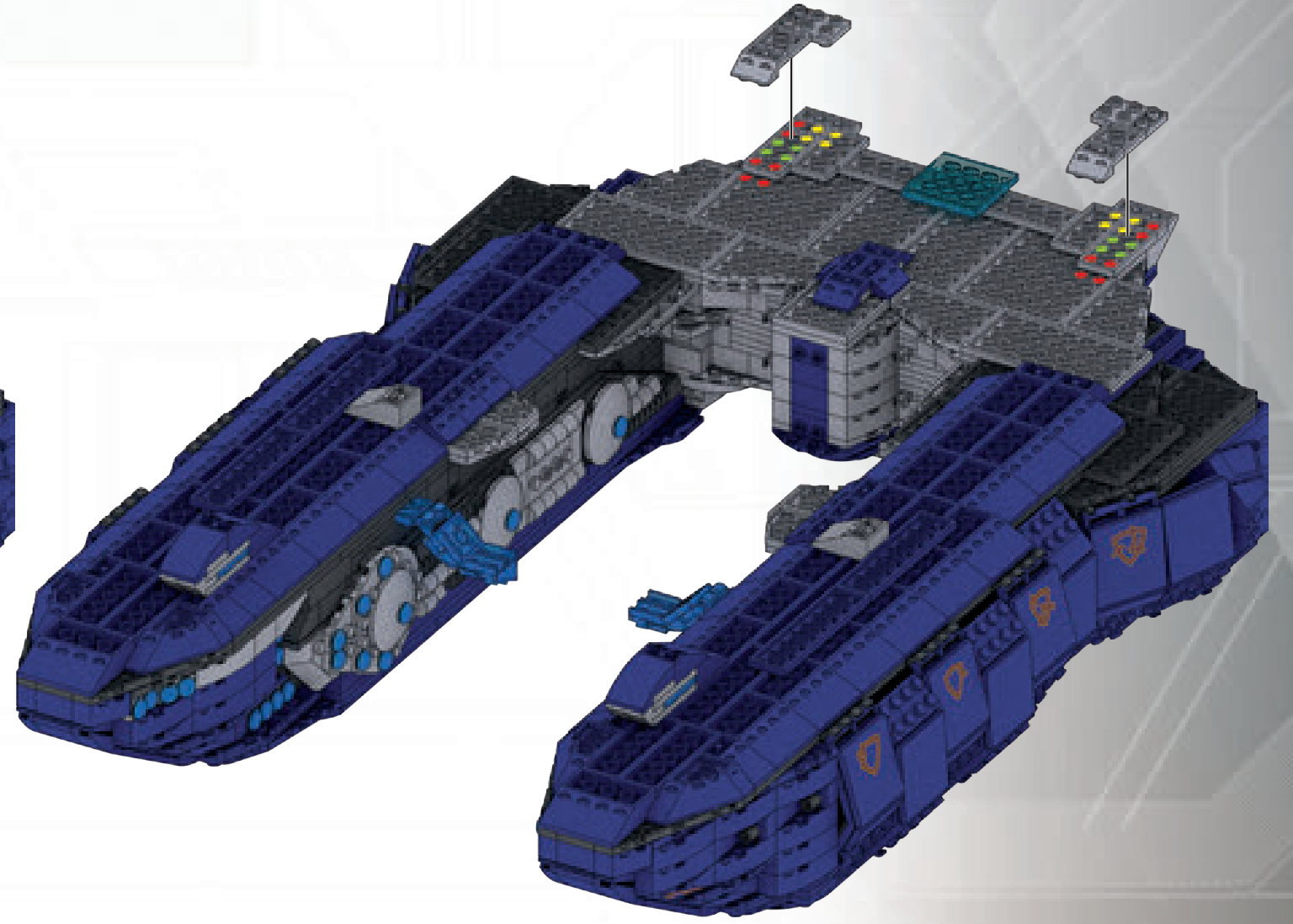
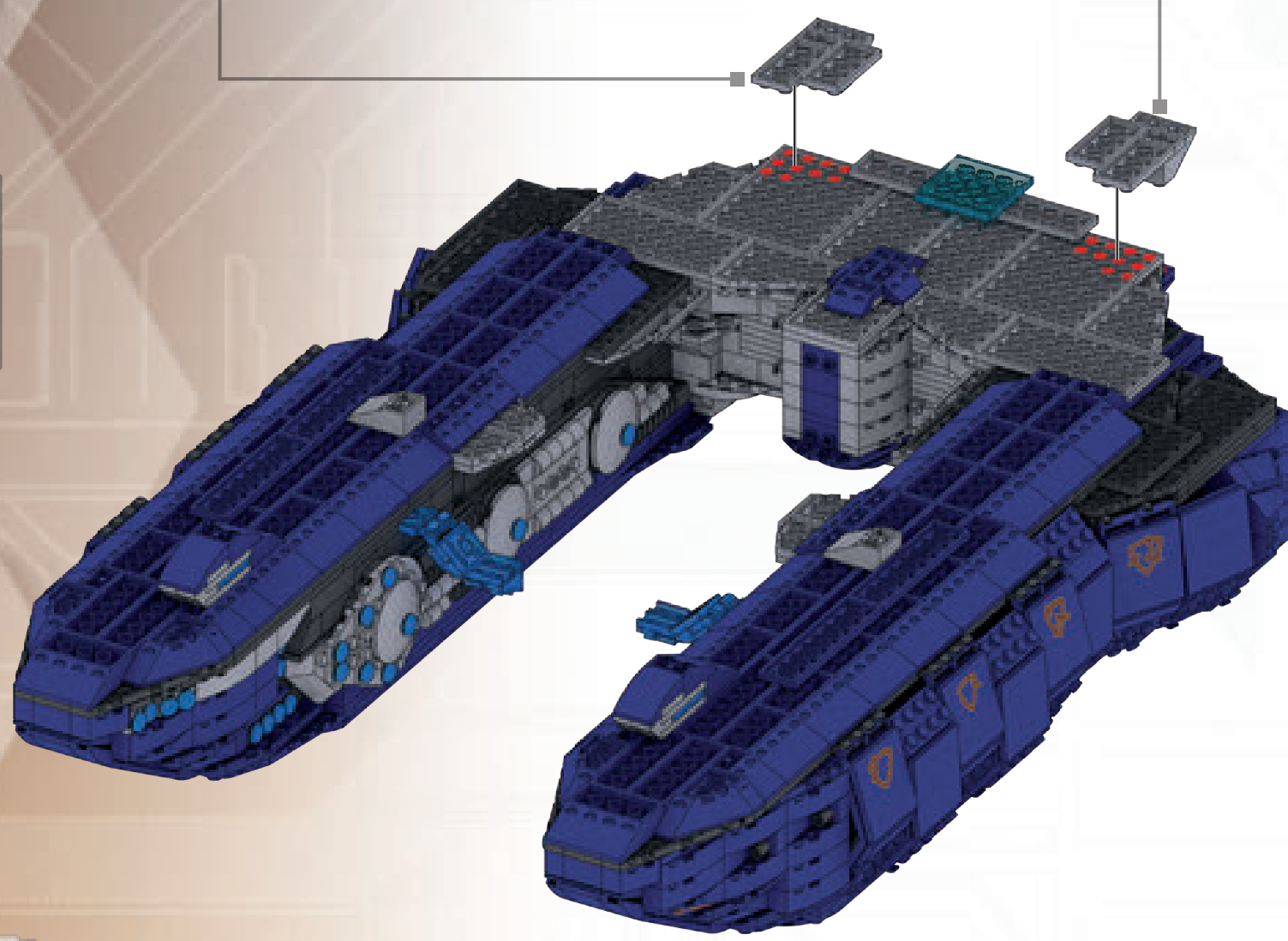

74



2X 2X

75

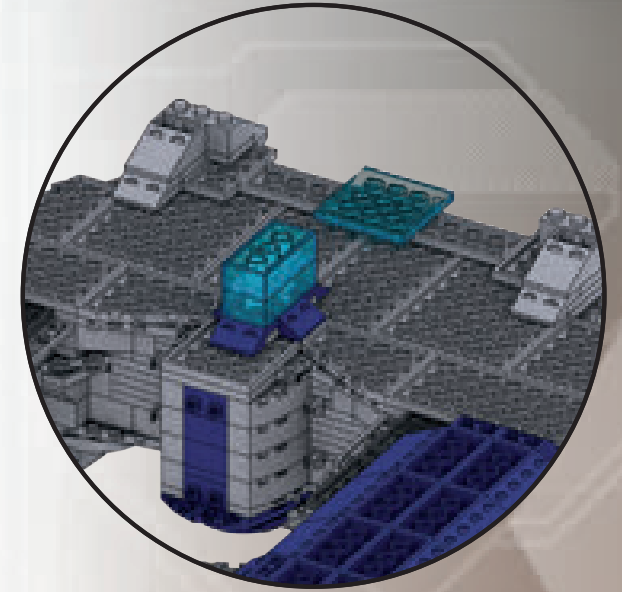
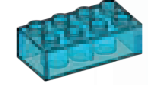

2X

Place temporary pieces
 Placer les pièces temporaires
 Colocar las piezas provisionales
 Colocar as peças provisórias
 Posizionare i pezzi provvisori
 Die vorübergehend benötigten Teile platzieren
 Umieść tymczasowe elementy
 Plaats tijdelijke delen
 Поместите временные детали
 Placer midlertidige stykker.
 Placera temporära delar
 Plasser midlertidige deler
 Aseta väliaikaiset osat
 Τοποθετήστε το προσωρινό κομμάτι
 Geçici parçaları yerleştirin
 放置临时件
 暫定ピースを配置してください
 ضع القطع المؤقتة

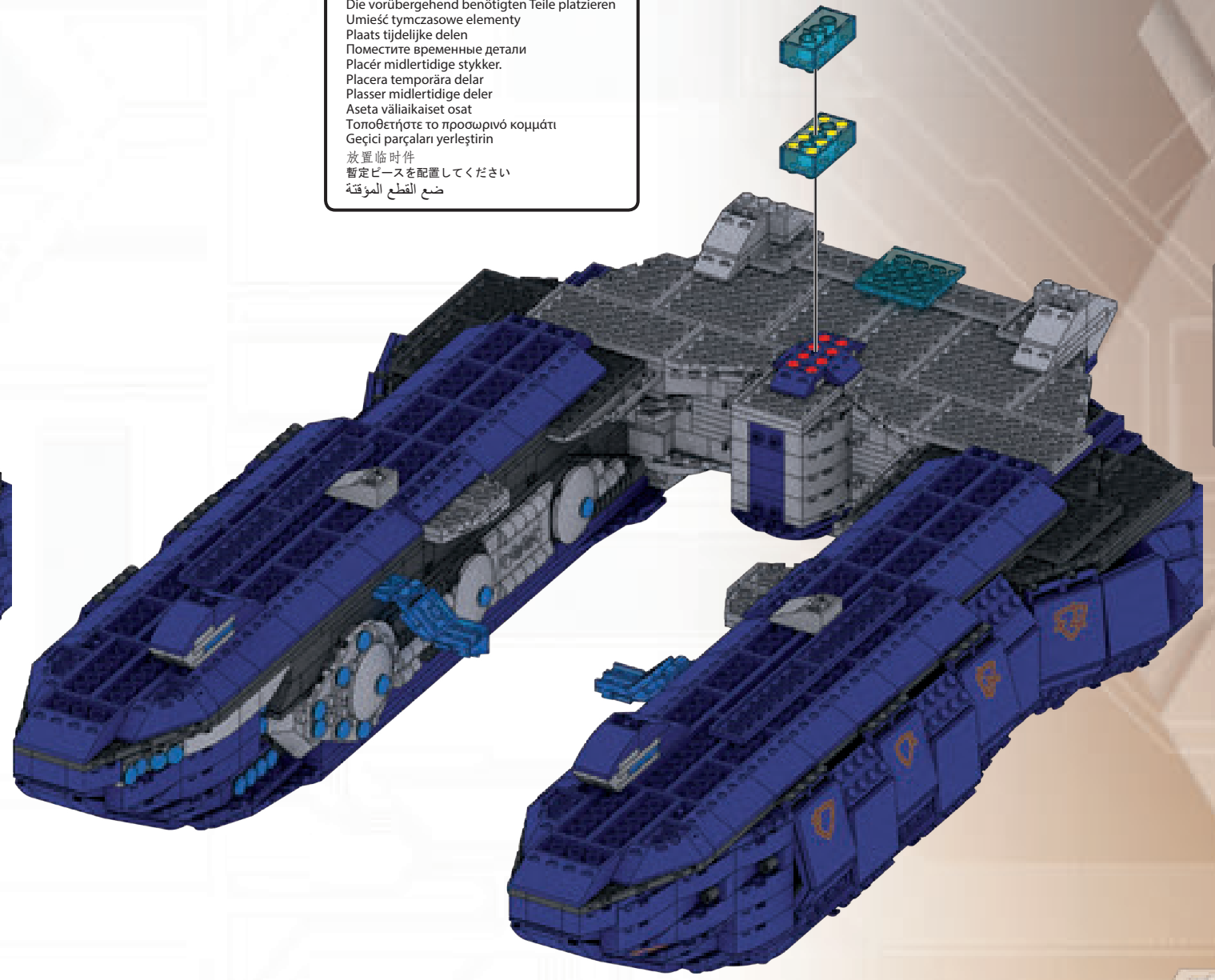
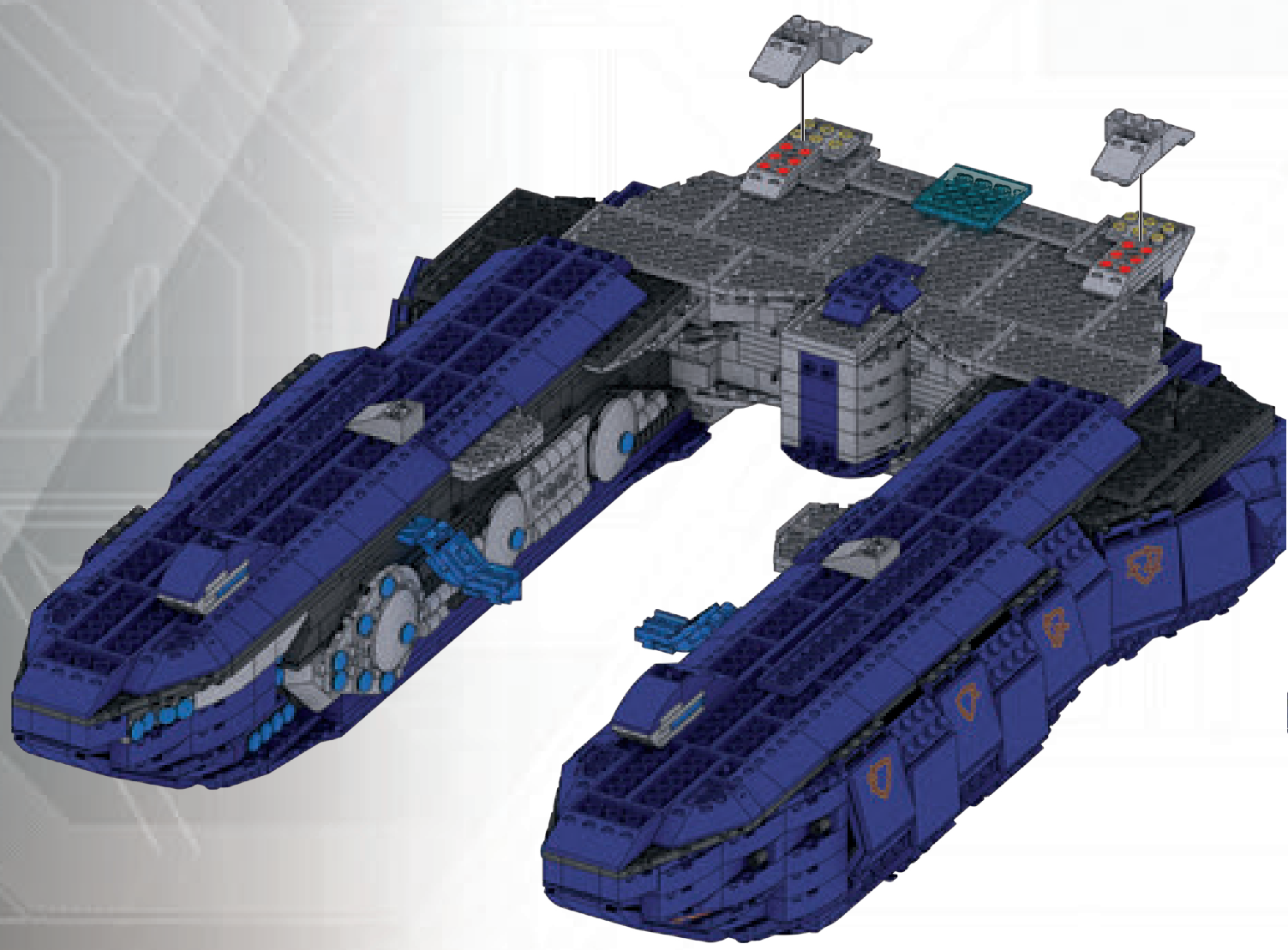

4



SECTION • SECCIÓN • ABSCHNITT
SECTIE • SEZIONE • SECÇÃO





5

94-113

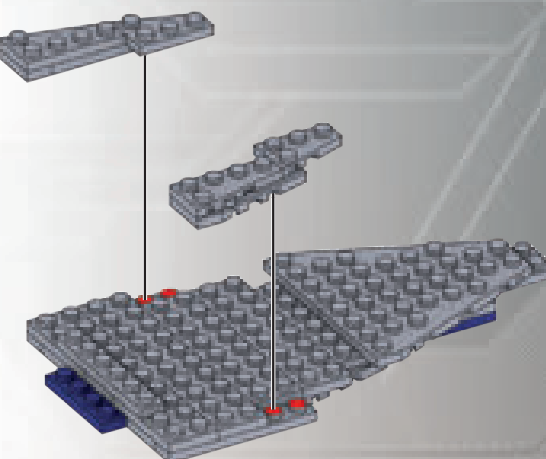
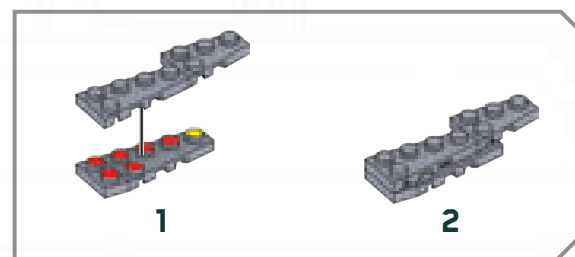
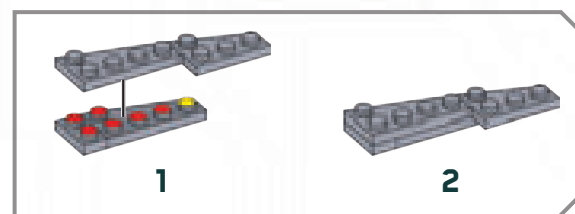
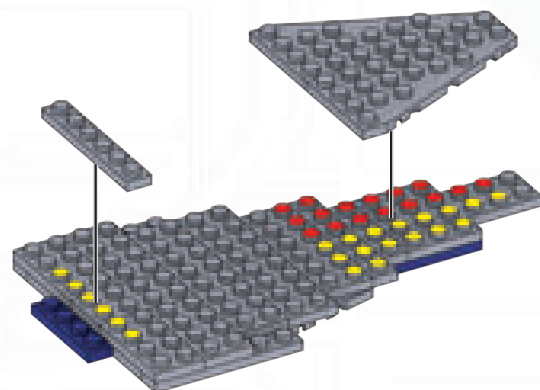
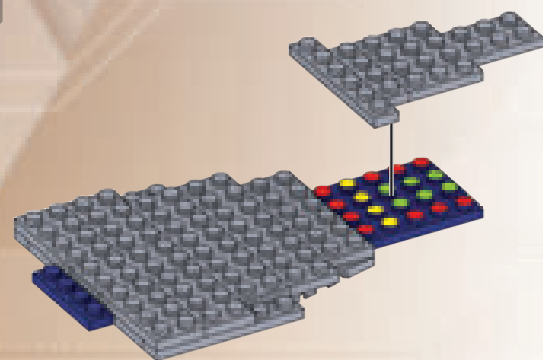
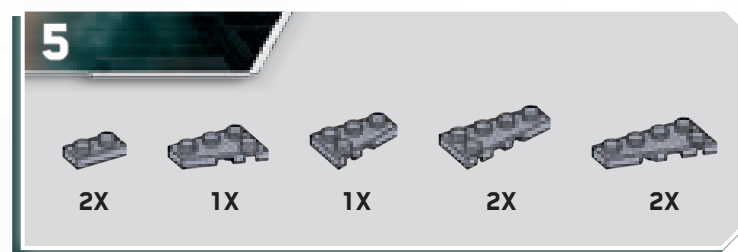
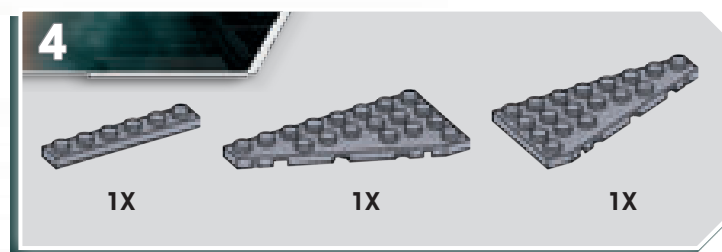
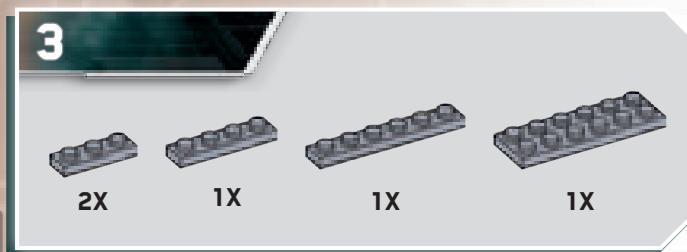
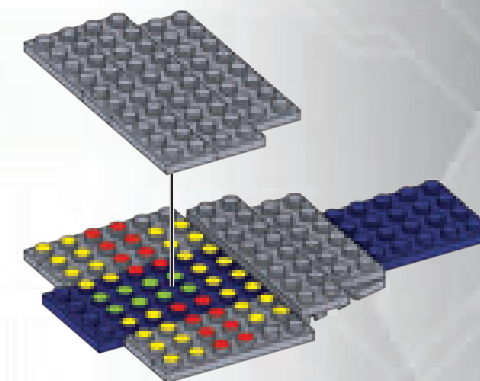
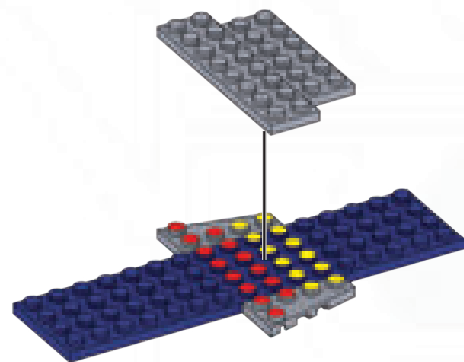
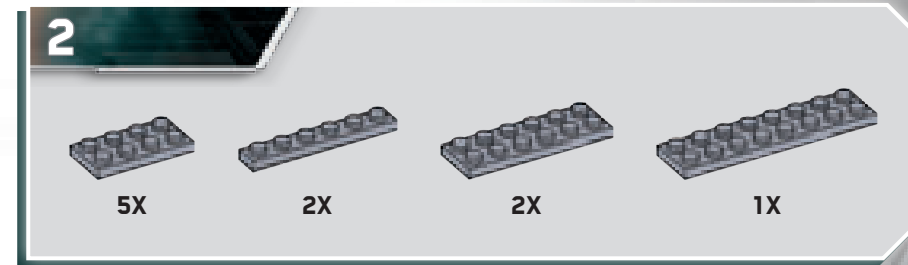
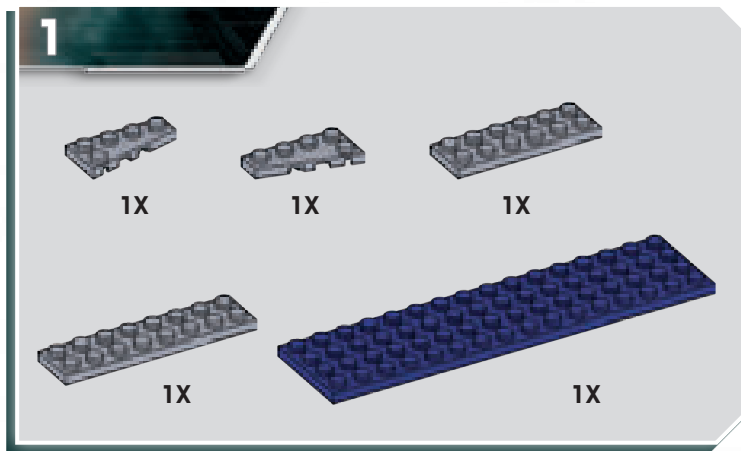

6

2X 2X 2X 1X 1X

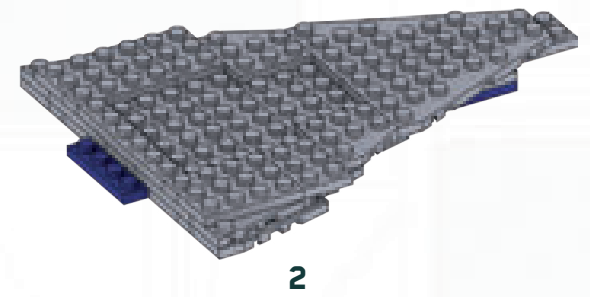
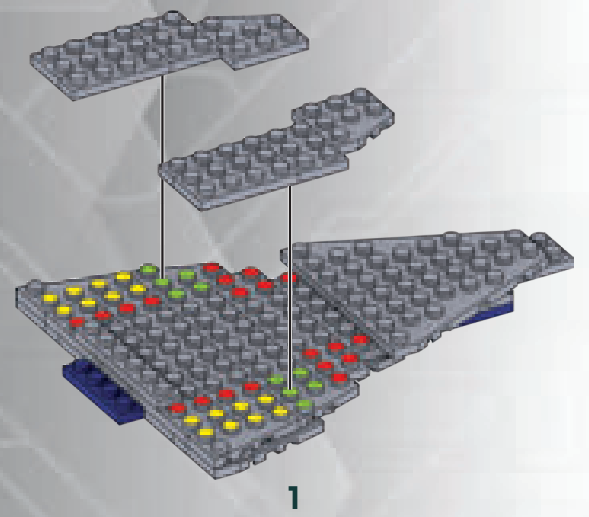

7

2X 2X 2X 2X

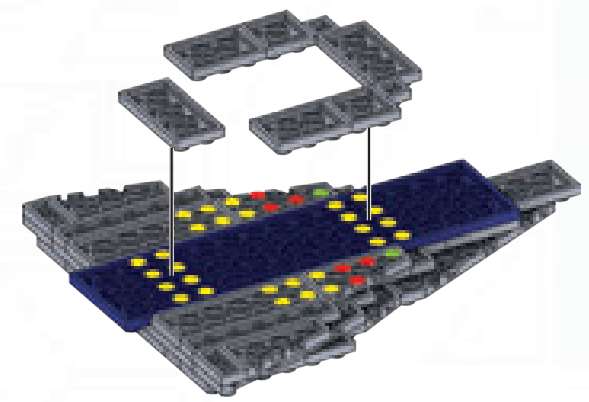

8

2X 2X 2X 1X 2X

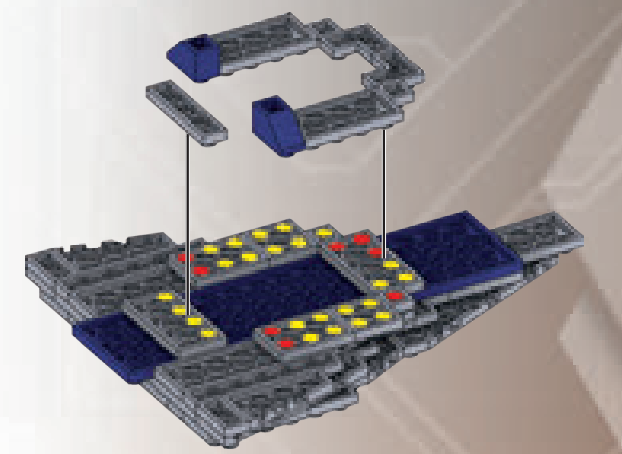

9

2X 2X 1X

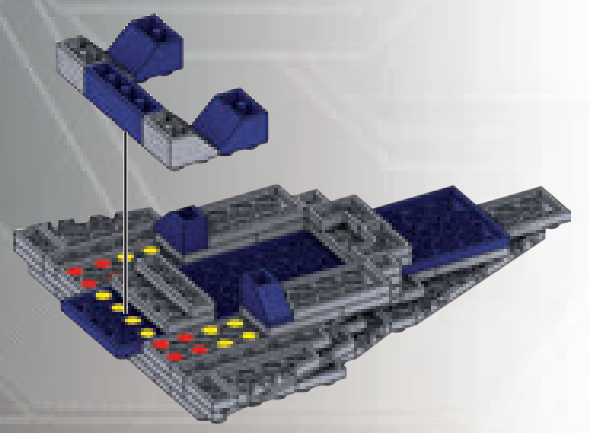

10

2X 4X X2

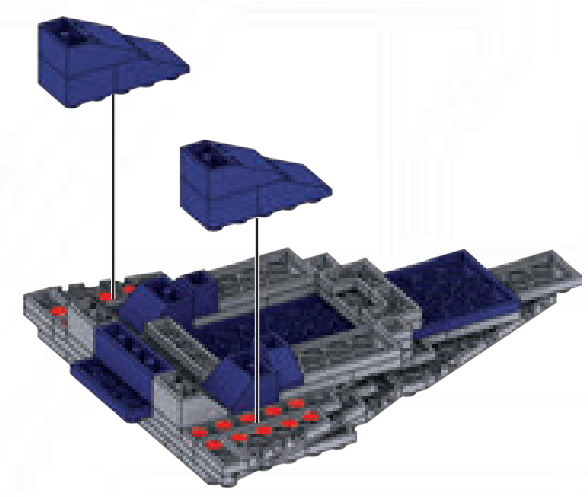

11

2X 2X 2X 2X 1X

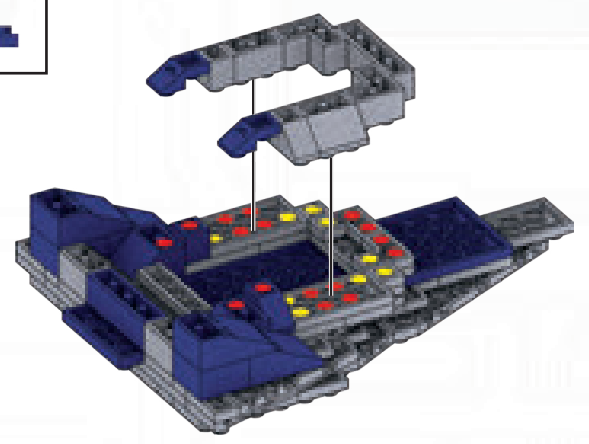
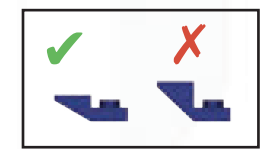

12

2X 2X 2X

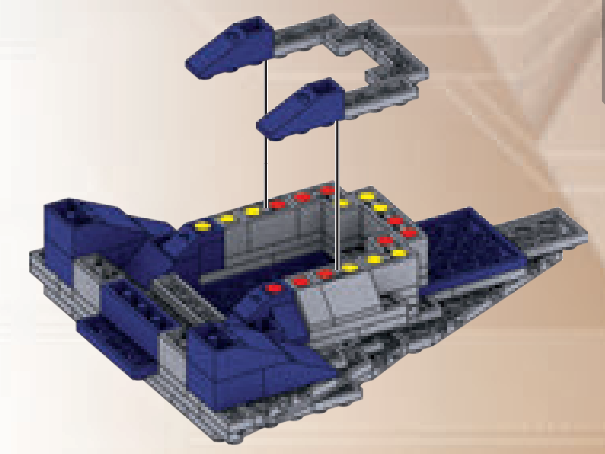

13

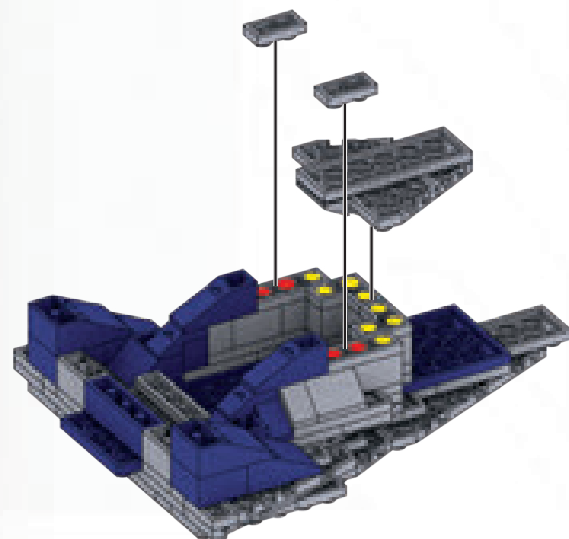
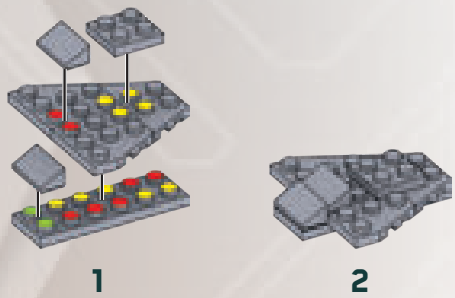
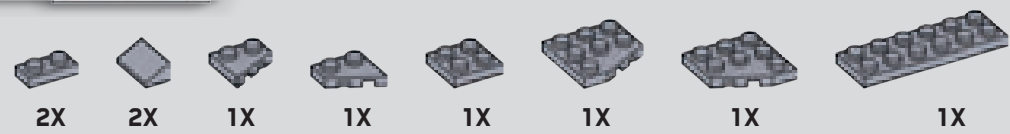

14

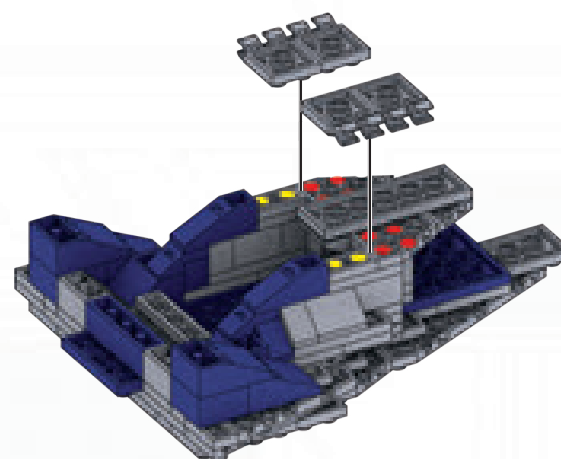

15

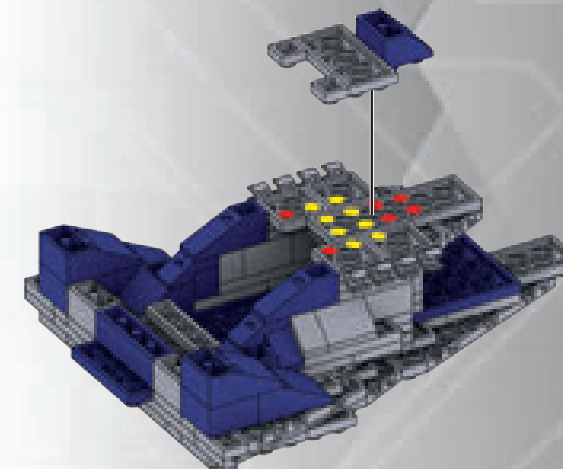

16

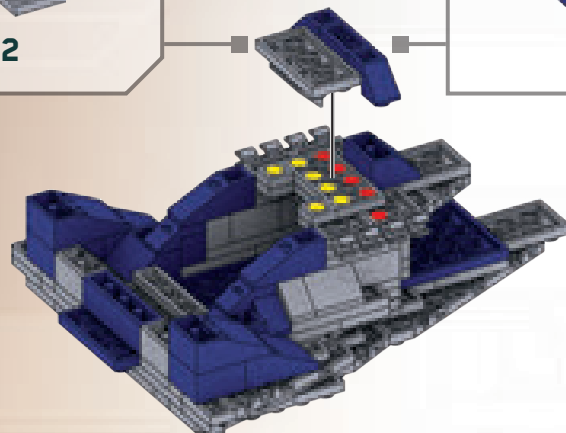
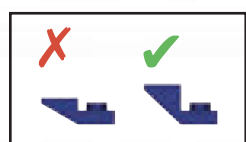

17

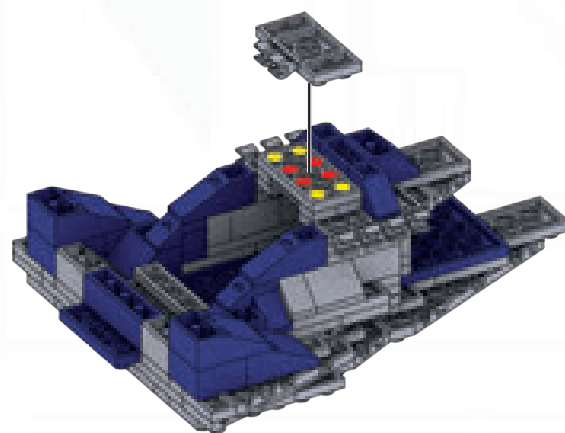

18

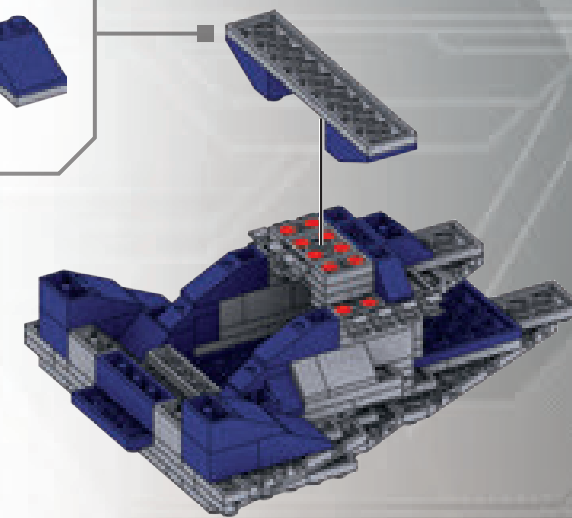
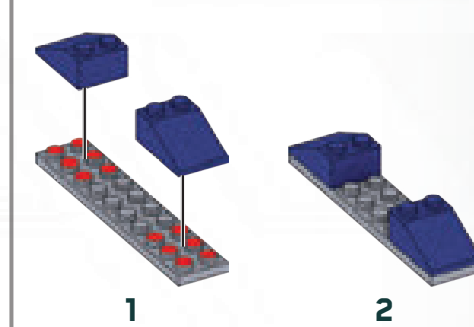

5

19

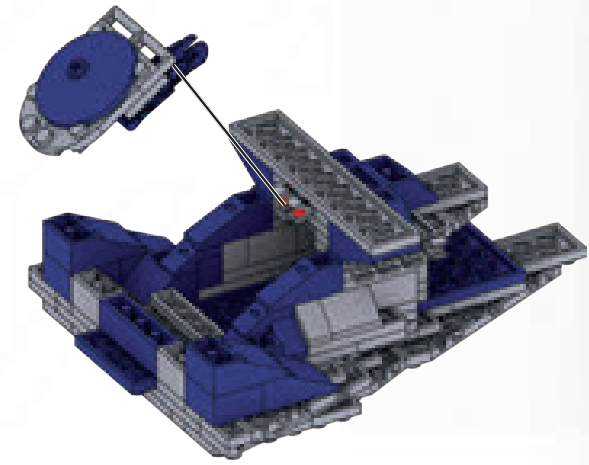
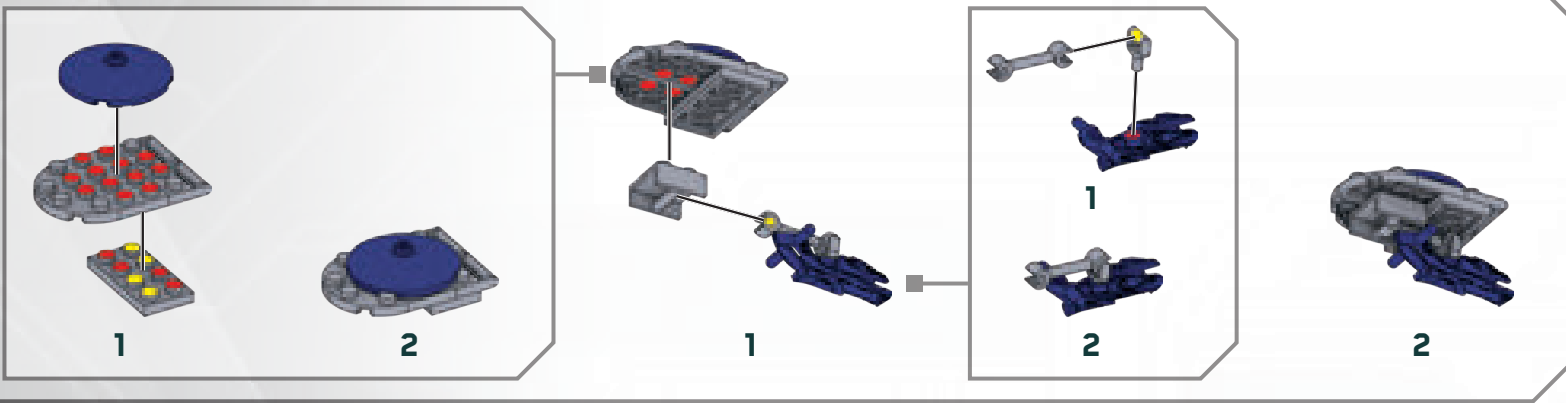

20



Place temporary pieces
 Placer les pièces temporaires
 Colocar las piezas provisionales
 Colocar as peças temporárias
 Posizionare i pezzi provvisori
 Die vorübergehend benötigten Teile platzieren
 Umieścić tymczasowe elementy
 Plaats tijdelijke delen
 Поместите временные детали
 Placer midlertidige stykker.
 Placera temporära delar
 Plaser midlertidige deler
 Aseta väliaikaiset osat
 Τοποθετήστε το προσωρινό κομμάτι
 Geçici parçaları yerleştirin
 放置临时件
 暂定ピースを配置してください
 ضع القطع المؤقتة

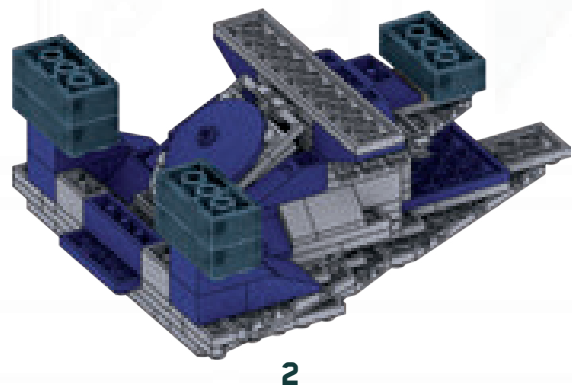
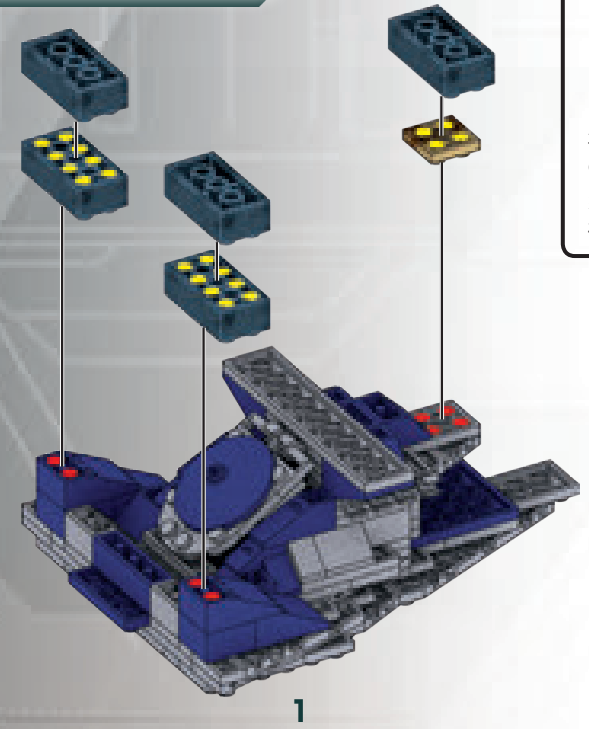

21

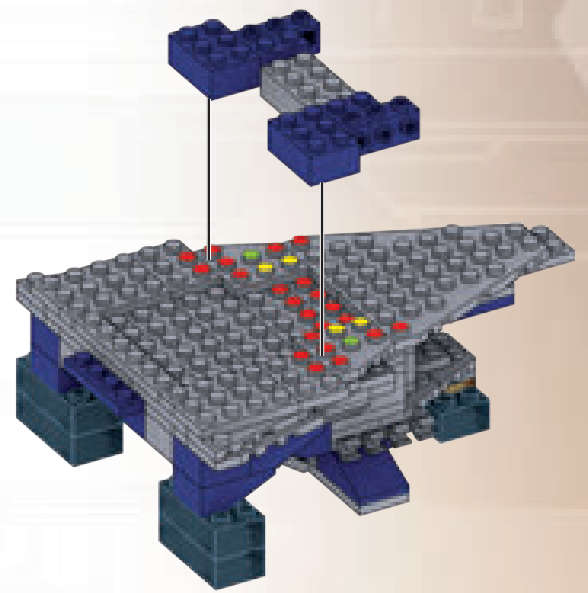
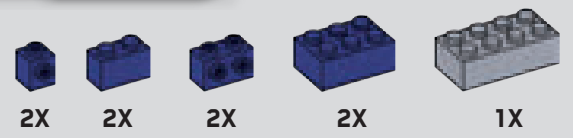

22

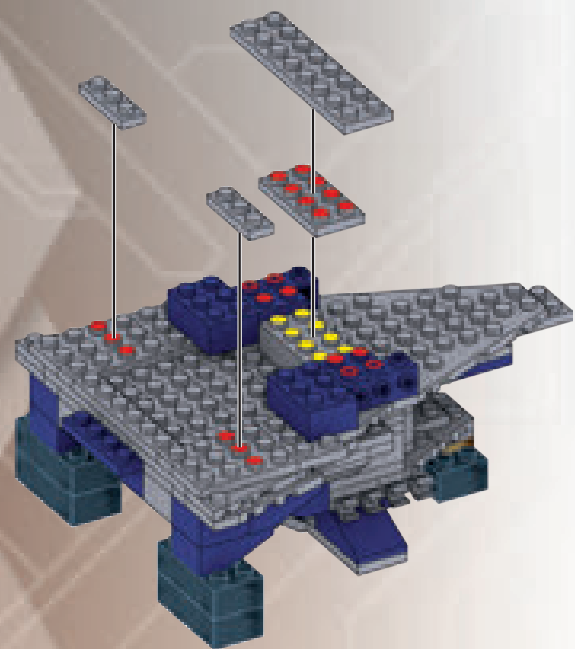

23

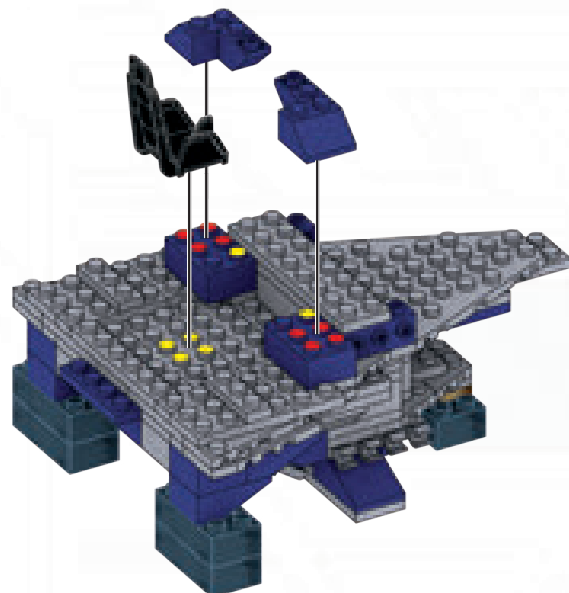
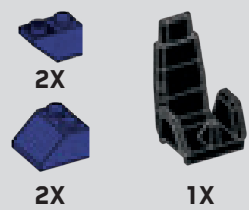

24

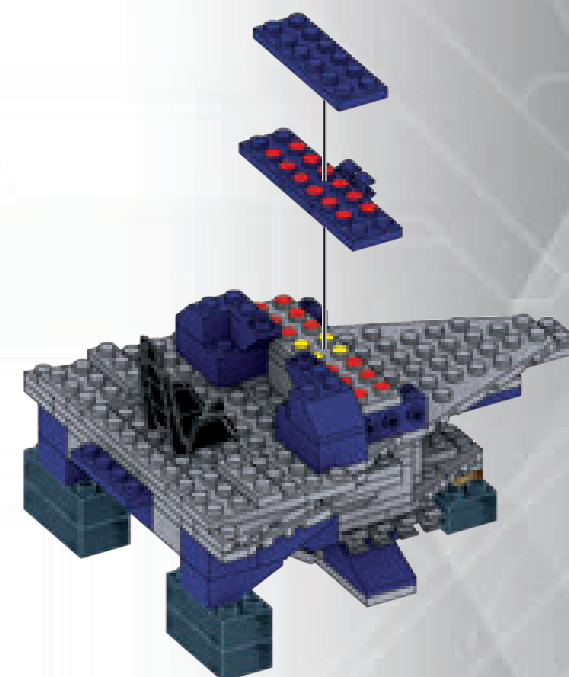

25

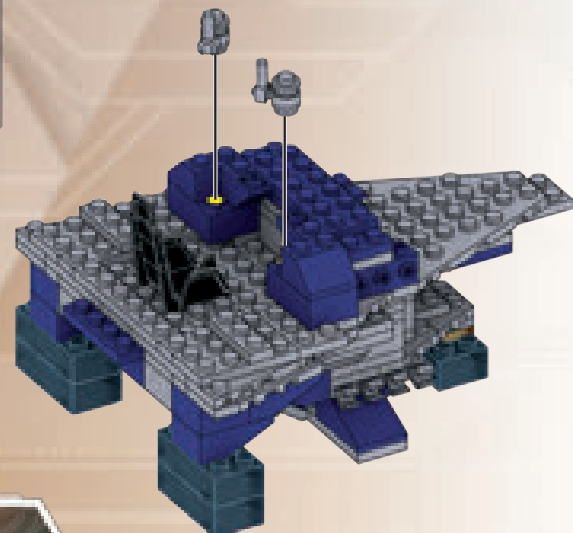

26

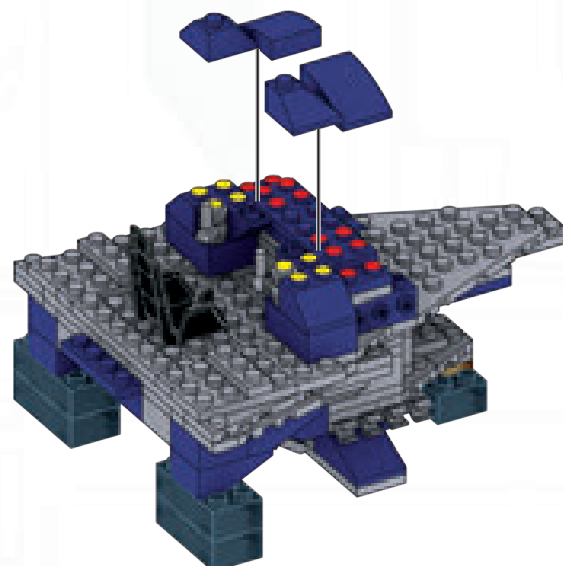

27

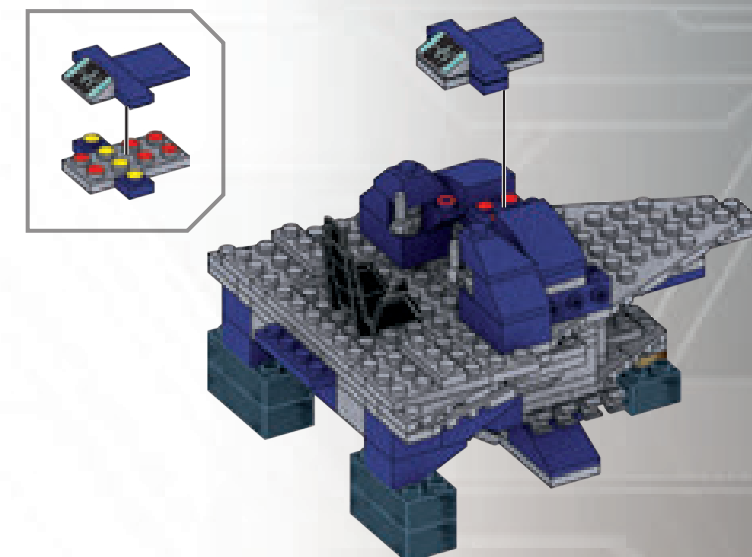

5

28

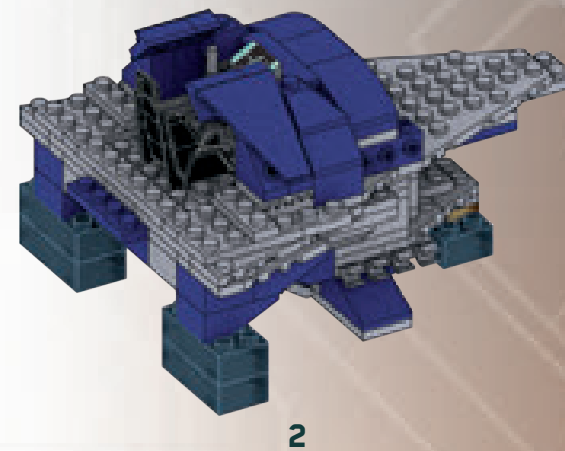
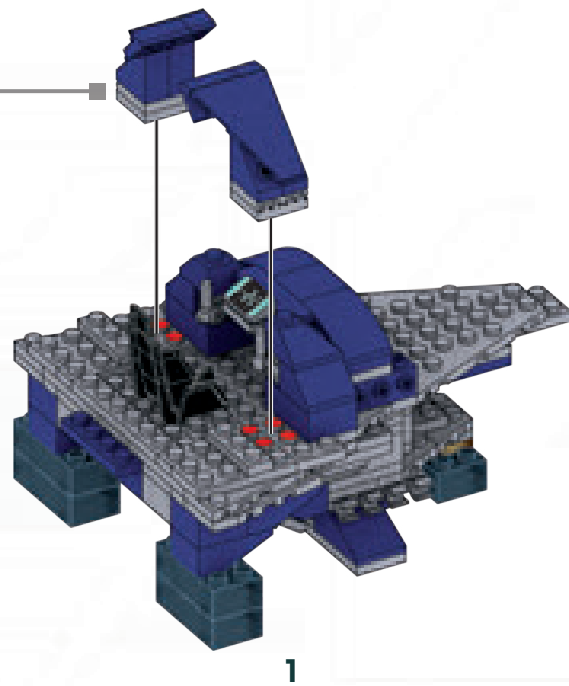
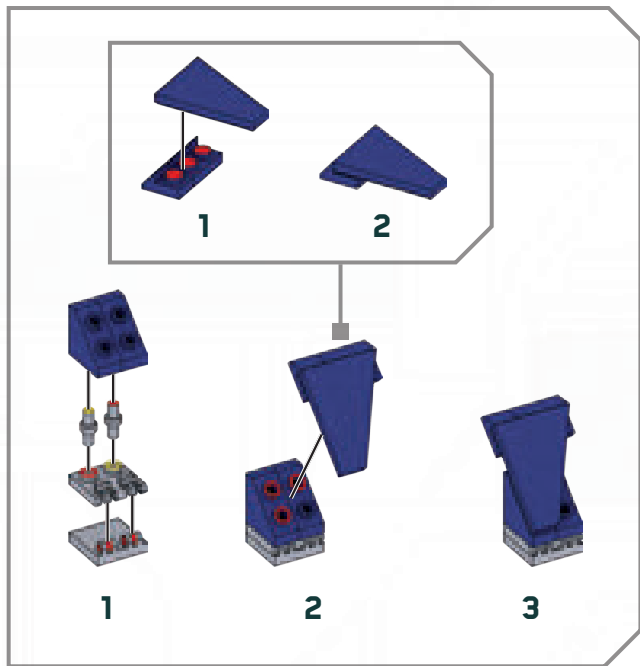
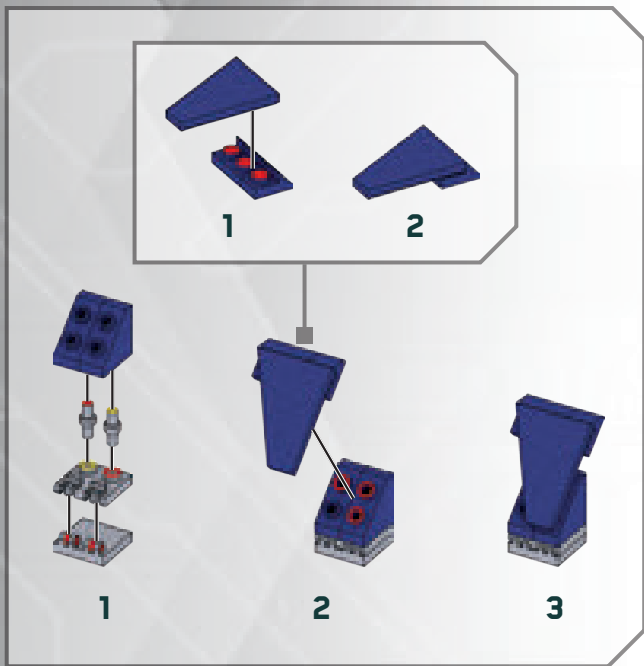

29

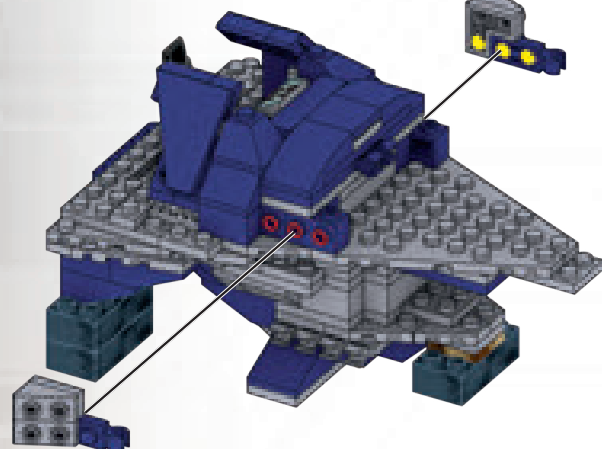
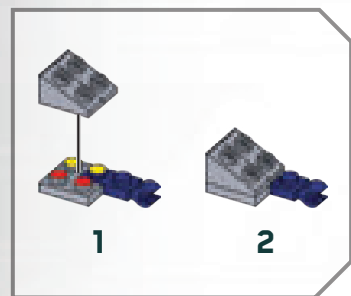
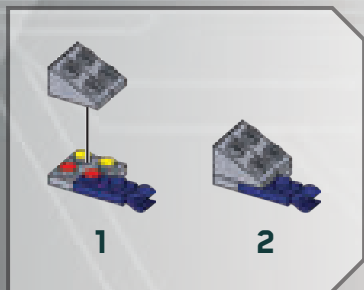

30

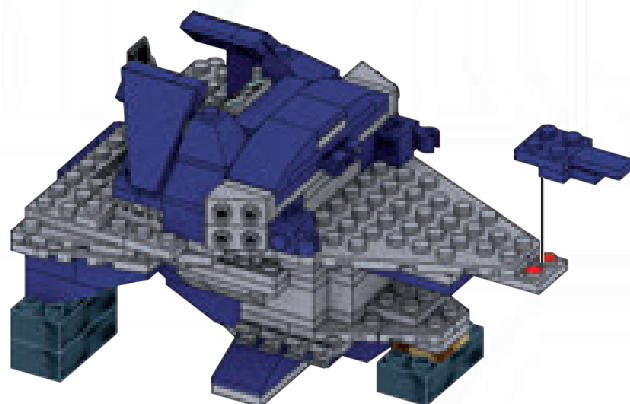
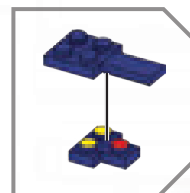

31

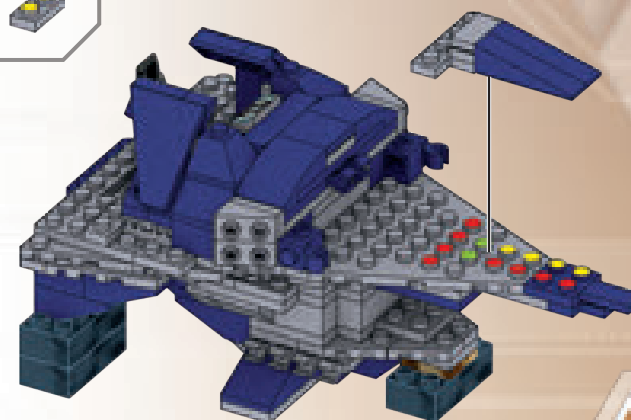
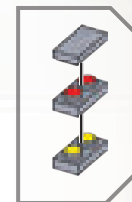

5