

MEGA
CONSTRUX™

nickelodeon

TEENAGE MUTANT NINJA
TURTLES



6+

DPW80

- 2x M1113W
- 2X MA1113APG
- 1X AM18560APG
- 3X AM18560AJW
- 3X AM75332X
- 1X MA03328AKM
- 1X MA03328AJW
- 2X MA1140AKM
- 1X MA1140AJW
- 1X MA17127AMC
- 2X MA17003APG
- 4X MA74397ARC
- 1X AM08412APG

- 8X AM17062APG
- 2X AM19650AMC
- 1x MA18232AJW
- 1x AM18260APG
- 5x MA19392APG
- 2x MA72233APG
- 1x AM74645APG
- 2x MA1086AKM
- 2x MA07590AKM
- 4x MA18901F
- 3x MA09393AKM
- 1x MA022501F

- 3x MA10273AKM
- 1x AM16967ACW
- 2x MA09013AKM
- 1x MA03773AJW
- 1x MA03773AKM
- 1x MA03772DH
- 2x MA18223AJW
- 2x AM74060AKM
- 1x MA1087AKM
- 2x MA1367ARC

- 1x AM76521ARC
- 1x AM18593AMC
- 1x AM18746AJW
- 1x AM73454APG
- 1x AM73332MM
- 1x AM73333AJW
- 1x AM77045ACW
- 1x AM77046ACW

- 1x AM75956AMC
- 1x AM75954AMC
- 1x AS9172006
- 1x AS9172007
- 1x AS9172007
- 2x AS-DPW80-04
- 2x AS9441301
- 1x AM73306MM

- 1x AM19390AJW
- 1x AS-DPW80-03
- 1x AS-DPW80-02
- 2x AM76818APG
- 1x AS-DPW80-01
- 1x AM77052MM



1x
FIG-DPW80-B



1x
FIG-DPW80-A

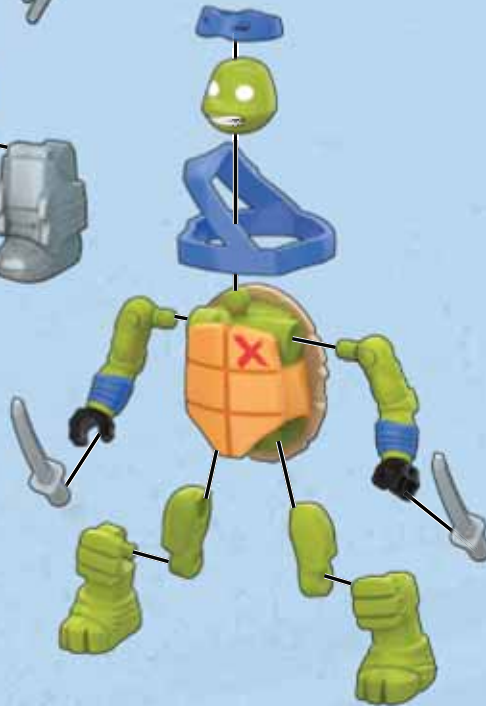

- ⚠ WARNING :
CHOKING HAZARD. - Small parts.
Not for children under 3 years.
- ⚠ ATTENTION :
DANGER D'ÉTOUFFEMENT. - Présence de petits éléments.
Ne convient pas aux enfants de moins de 3 ans.
- ⚠ 警告:
噎住危險。包含有小部件
不适合3岁以下的小孩玩。
- ⚠ 警告:
小さな部品が含まれています
3歳以下の子どもには与えないで下さい。

⚠ تحذير :
خطر الاختناق - قطع صغيرة.
غير صالحة للأطفال أقل من 3 سنوات.

- ADVERTENCIA: Peligro de asfixia. Juguete no recomendado para menores de 3 años, porque contiene piezas pequeñas que podrían provocar asfixia en casode ser ingeridas o inhaladas por el/la niño/a.
- ATENÇÃO: Não recomendável para crianças com menos de 36 meses. Contém peças pequenas capazes de criar risco de asfixia.
- AVVERTENZA: Contiene pezzi di piccole dimensioni.
- ACHTUNG: Kleine Teile.
- OSTRZEŻENIE: Małe części
- WAARSCHUWING: Kleine onderdelen
- ПРЕДУПРЕЖДЕНИЕ: Мелкие детали
- ADVARSEL: Små dele.
- VARNING: Smådelar
- ADVARSEL: Små deler.
- VAROITUS: Pieniä osia
- ΠΡΟΣΟΧΗ: Περιλαμβάνονται μικρά κομμάτια.
- UYARI: BOĞULMA TEHLİKESİ - Küçük Parçalar İçerir. 3 yaşından küçük çocuklar için uygun değildir.



Please read these instructions carefully before first use and keep them for future reference.
Il est recommandé de lire attentivement ce feuillet avant la première utilisation et de le conserver pour référence future.
Leer estas instrucciones cuidadosamente antes de la primera utilización y guardarlas para referencia futura.
Leia as instruções antes do primeiro uso e guarde-as para futura referência.
Leggere le istruzioni prima di cominciare ad usare il gioco e conservarle per referenze future.
Die Gebrauchsanleitung bitte durchlesen und aufbewahren.

Proszę uważnie przeczytać instrukcję obsługi przed pierwszym użyciem, a następnie zachować ją na przyszłość.
Wij raden u aan deze handleiding zorgvuldig te lezen en te bewaren voor eventuele raadpleging op een later tijdstip.
Внимательно прочитайте инструкцию перед первым использованием и сохраните ее для дальнейшего использования.
Vær venlig at læse disse instruktioner omhyggeligt inden ibrugtaget og opbevar dem til fremtidig brug.
Läs noggrant igenom dessa instruktioner innan du använder produkten för första gången och spara dem för ev. framtida frågor.
Les disse instruksjonene nøye før første gangs bruk, og ta vare på dem for fremtidige oppslag.
Lue nämä ohjeet huolellisesti ennen ensimmäistä käyttöä ja säilytä ne myöhempää tarvetta varten.
Διαβάστε προσεκτικά τις οδηγίες πριν από τη χρήση και κρατήστε τις για μελλοντική αναφορά.
İlk kullanımdan önce talimatları dikkatlice okumanızı ve bu bilgileri ileride tekrar bakabilmek için saklamanızı öneririz.
第一次使用前，請仔細閱讀本說明書並保留以備將來參考。
初めてご使用になる前に、この説明書をよくお読みください。また、本書は将来いつでも参照できるように保管してください。
يجب قراءة هذه التعليمات بعناية قبل الاستخدام والاحتفاظ بها للعودة إليها مستقبلاً.

© 2016 Viacom Overseas Holdings C.V. All Rights Reserved. Teenage Mutant Ninja Turtles and all related titles, logos and characters are trademarks of Viacom Overseas Holdings C.V.

PLAY.MEGAONSTRUX.COM

Ⓟ D714,887



1

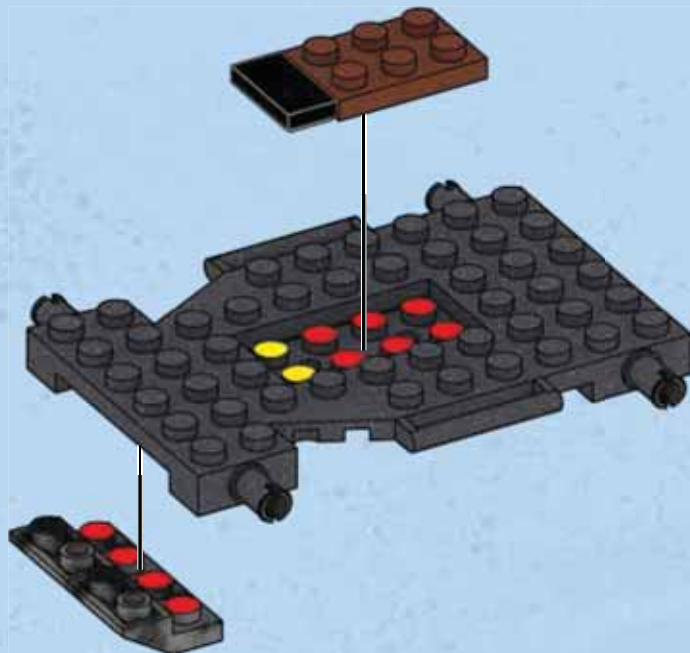
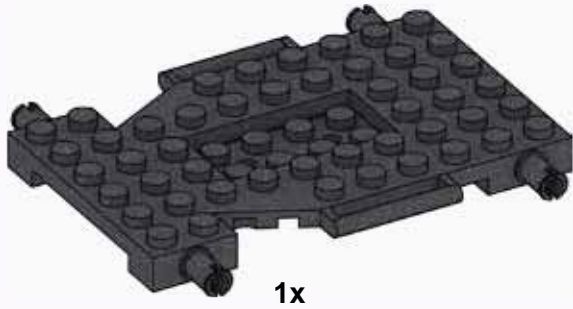
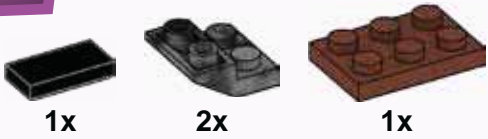

2

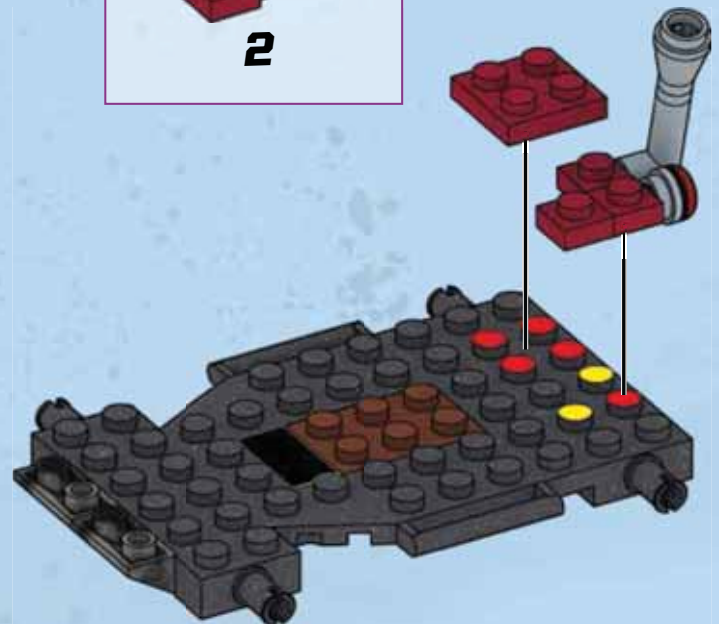
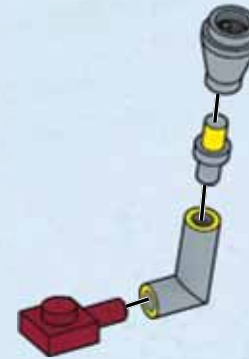
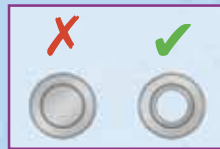

3



3x



2x

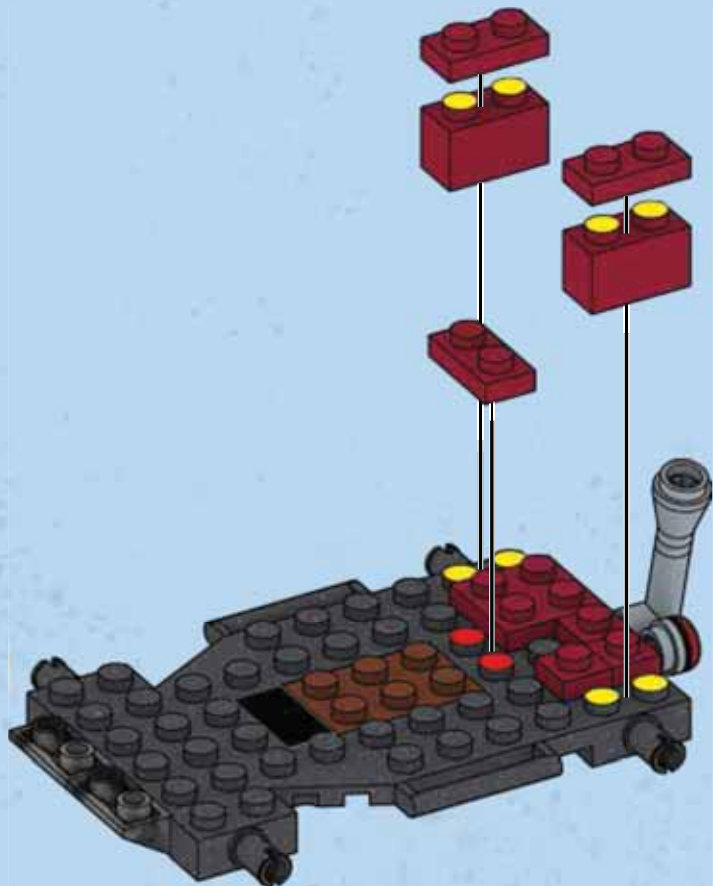

4



2x

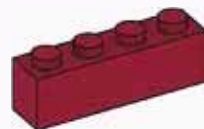

1x



1x

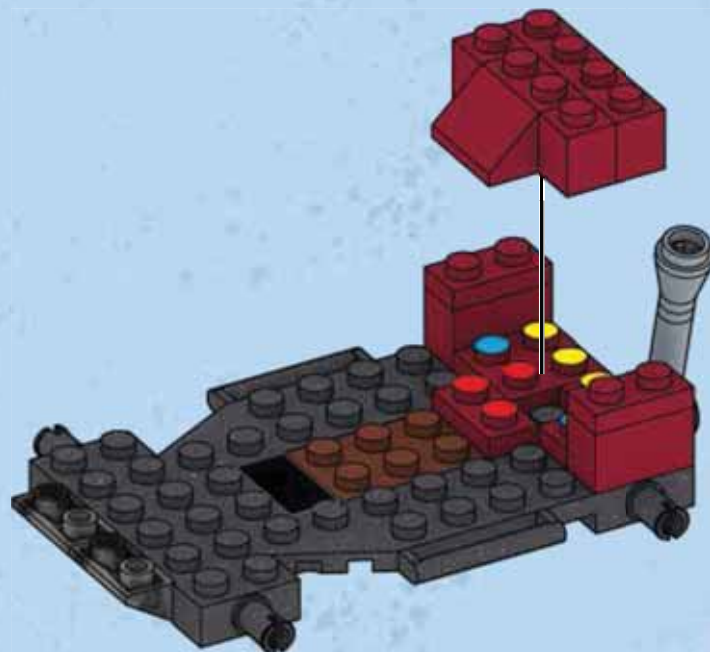

5



1x



2x

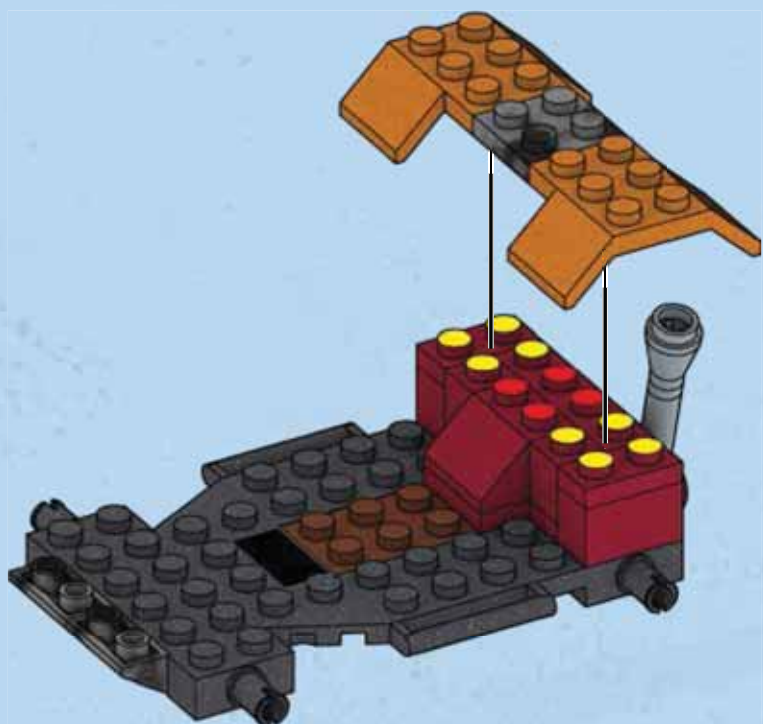

6



1x



1x

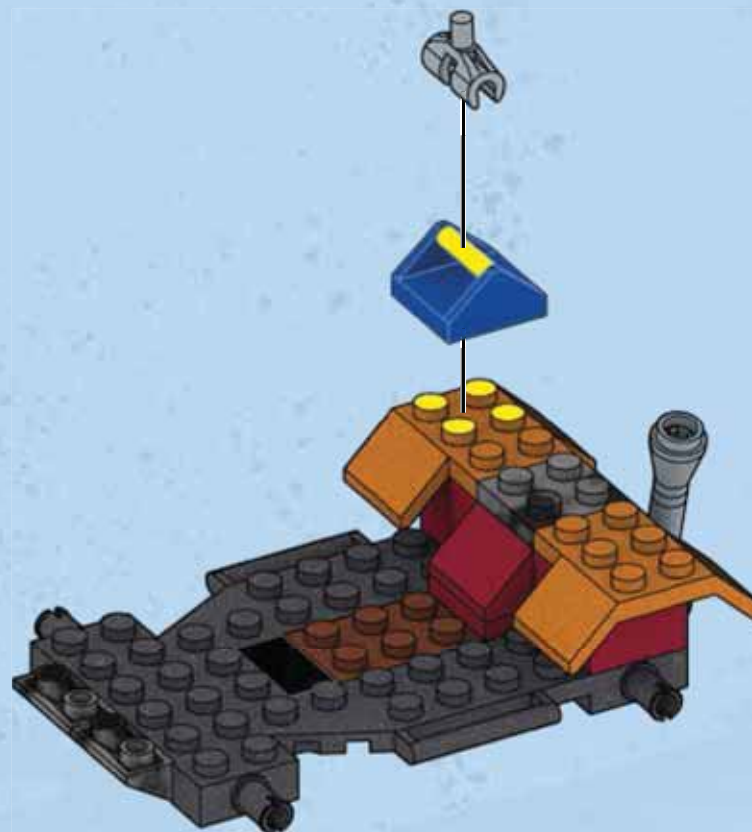

7



4x



2x



2x

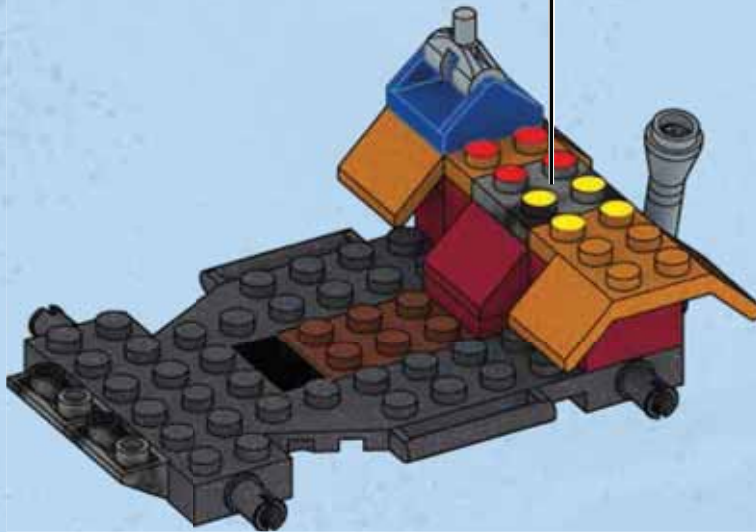

8



1x



1x



1x



1x



1



2



9



2x



4x

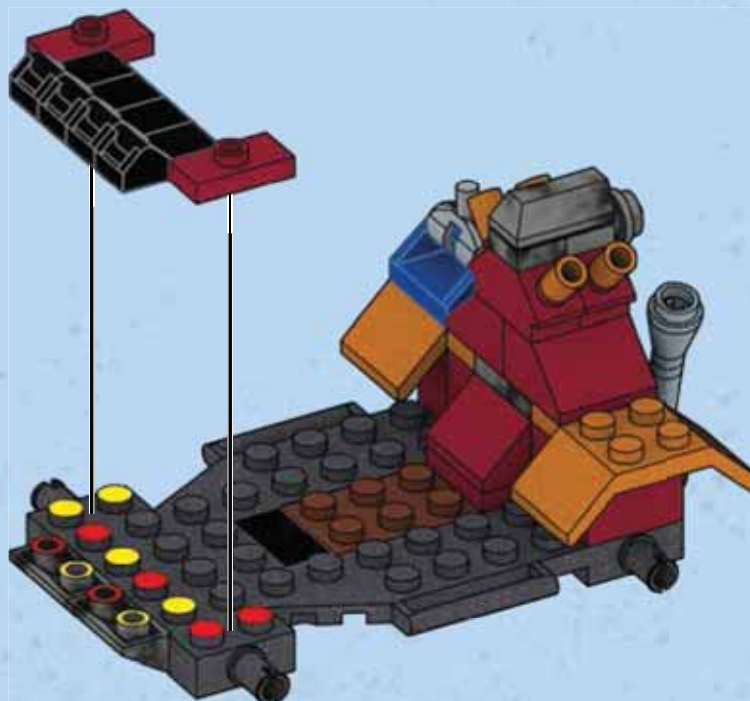

10



2x



1x



1x

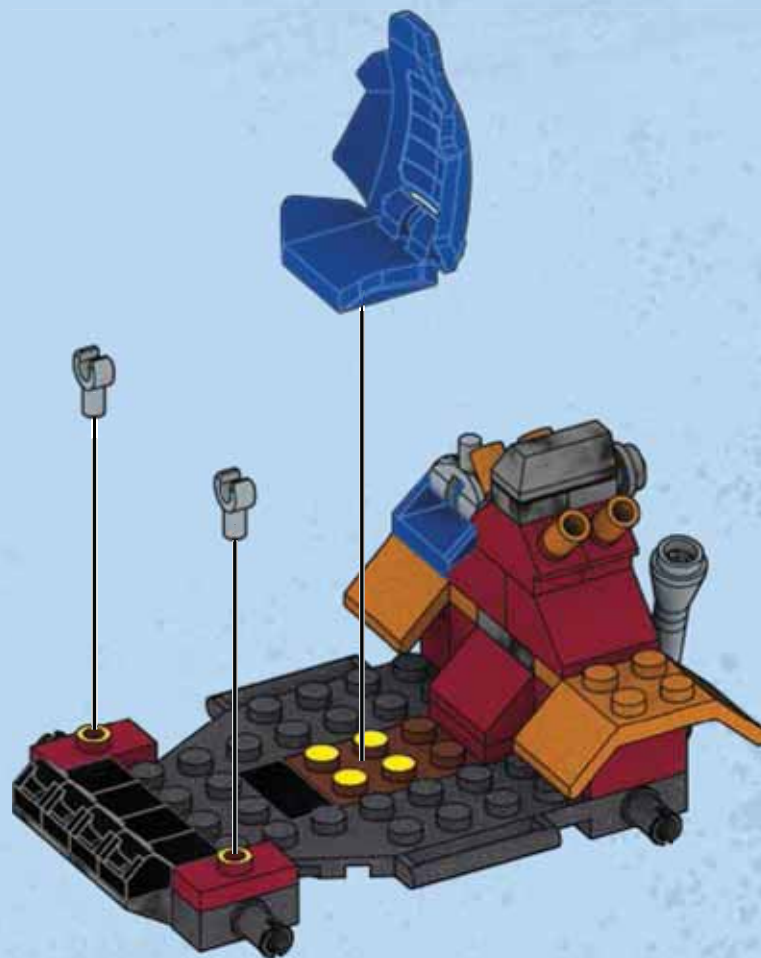
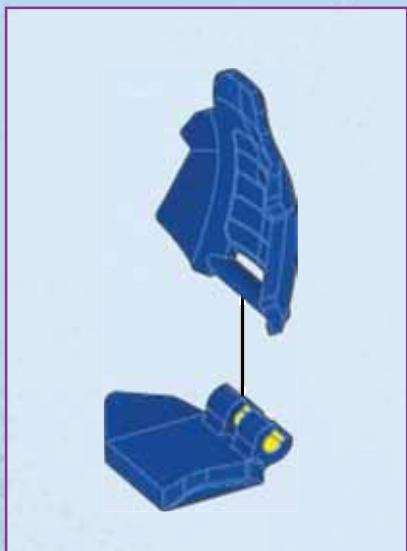

11



4x



2x



2x



2x



1



2

x2

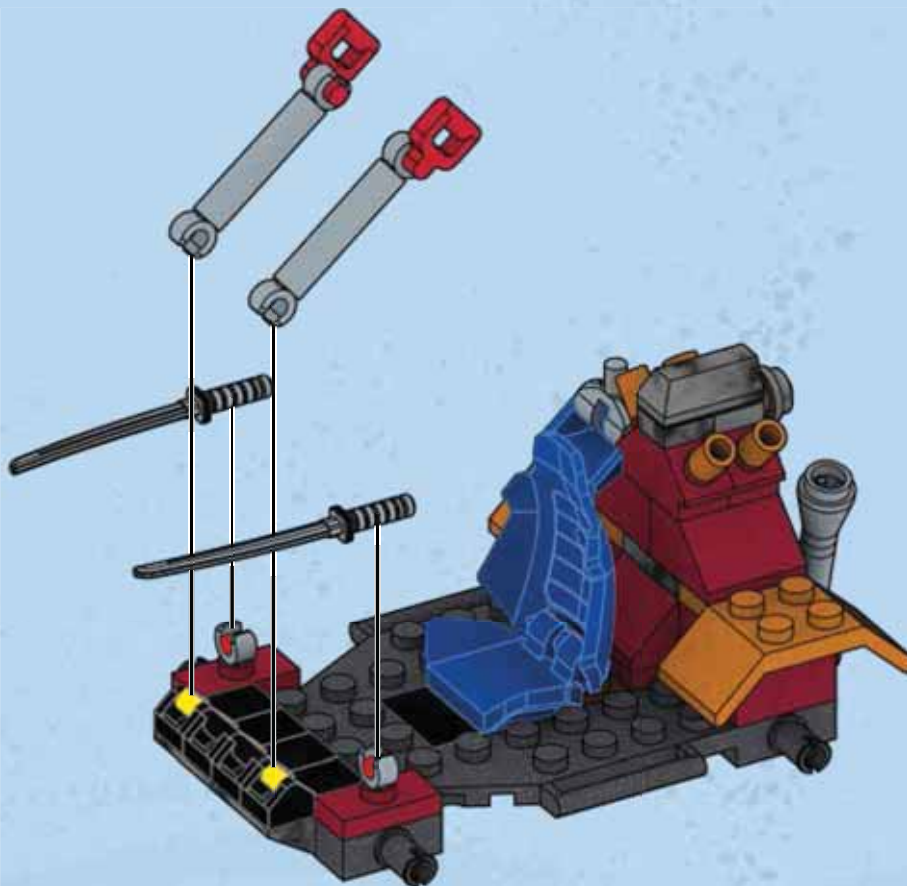

12

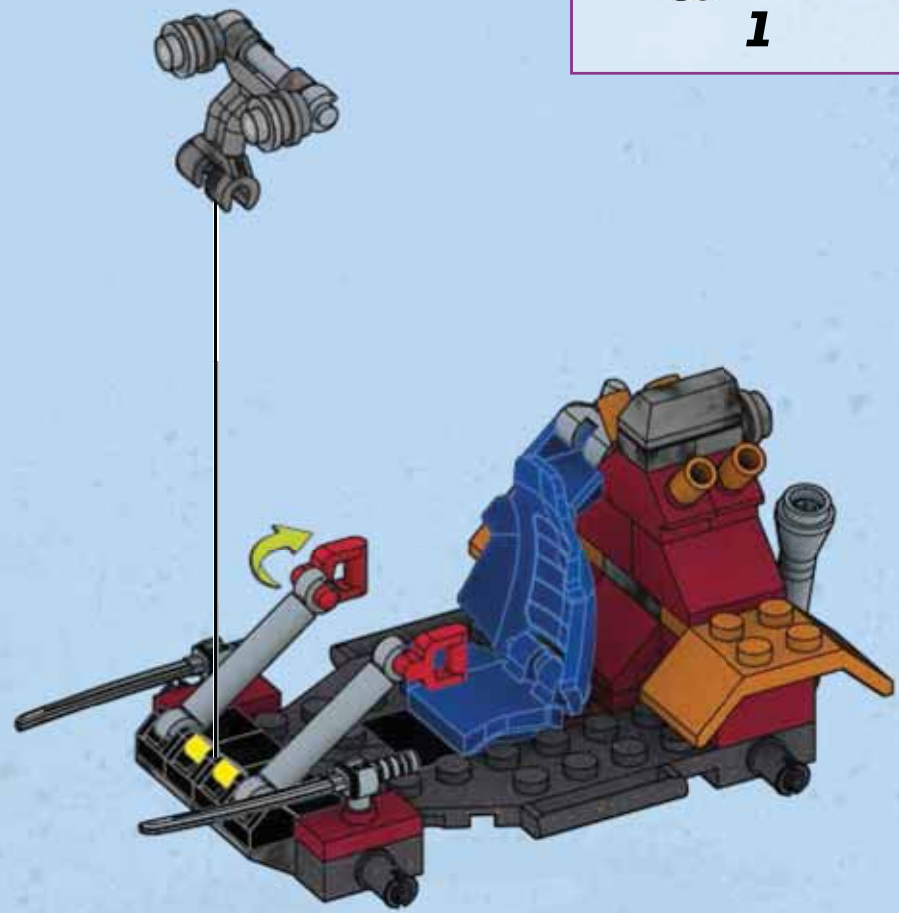
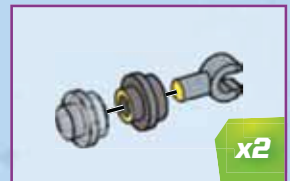
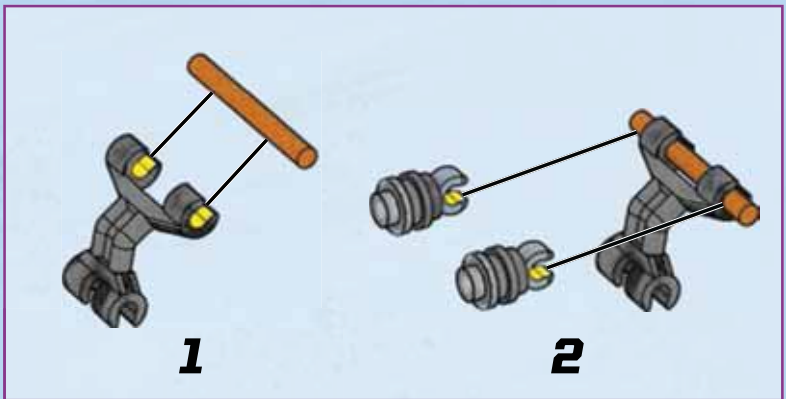

13



1x



1x



2x

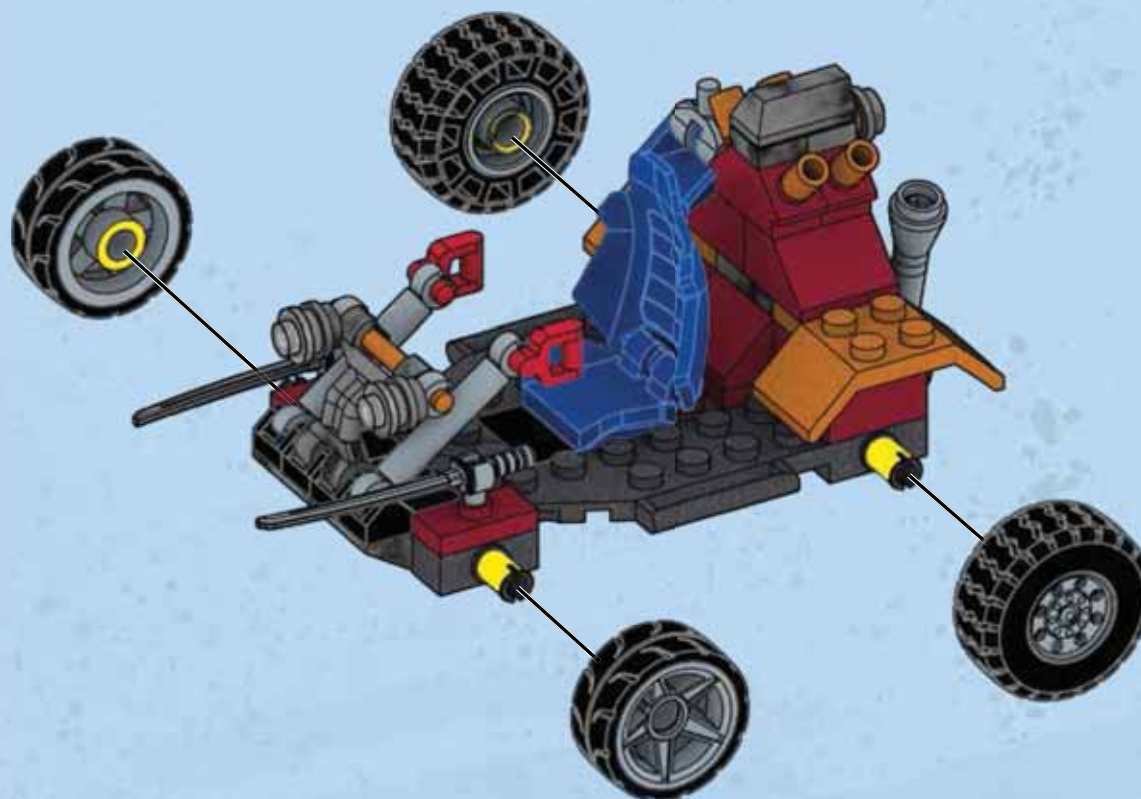

14



1x

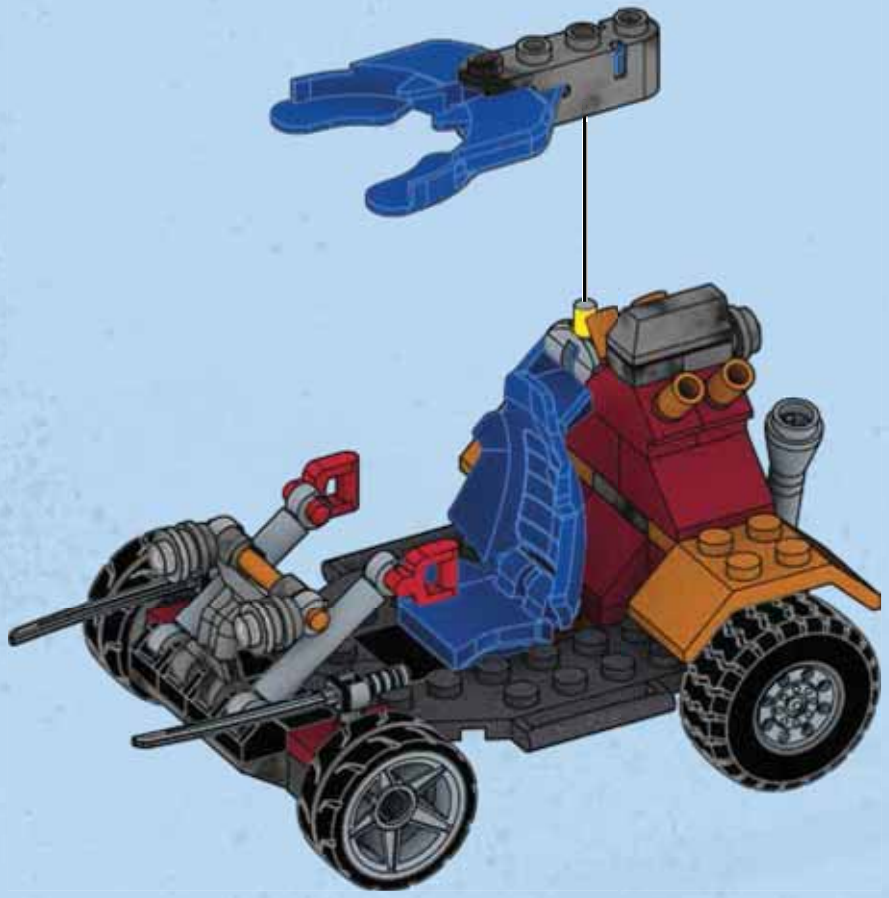

1

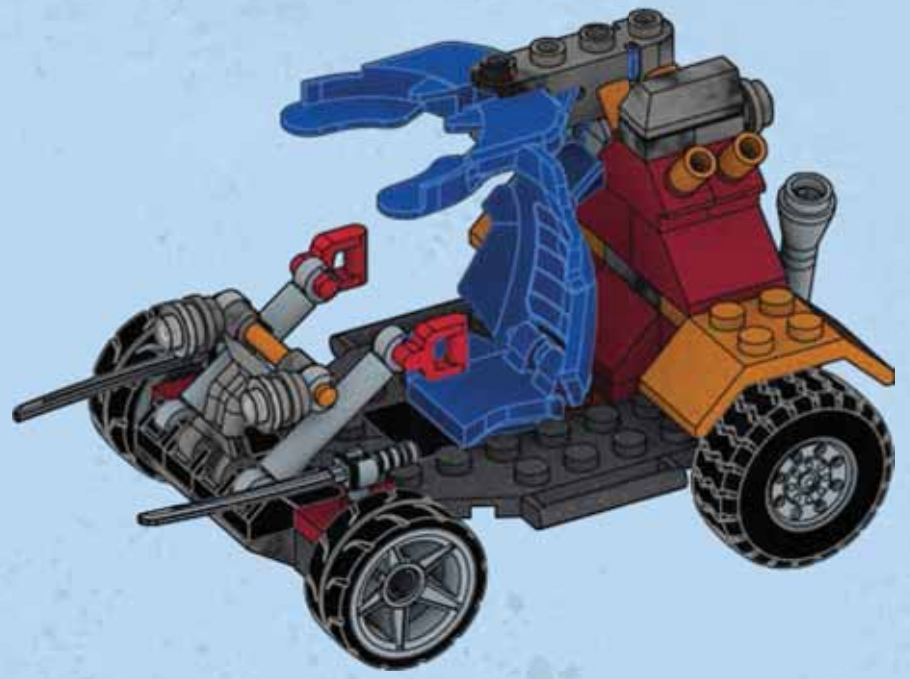

2



15



1x



1x

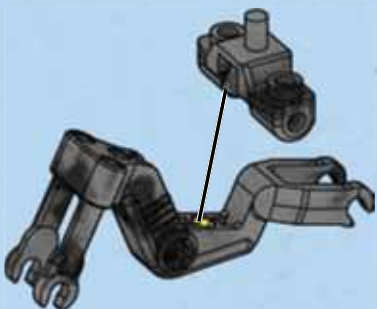

16



1x



1x



1x



1



2



17

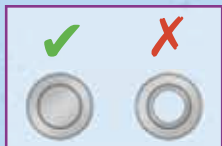

18



19



1x



1x



1x

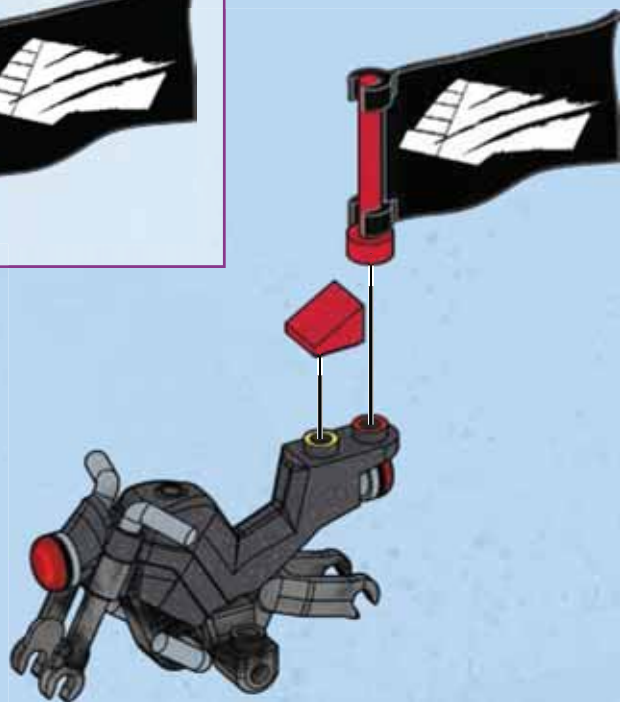
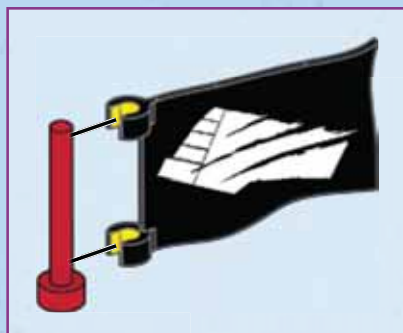

20



2x

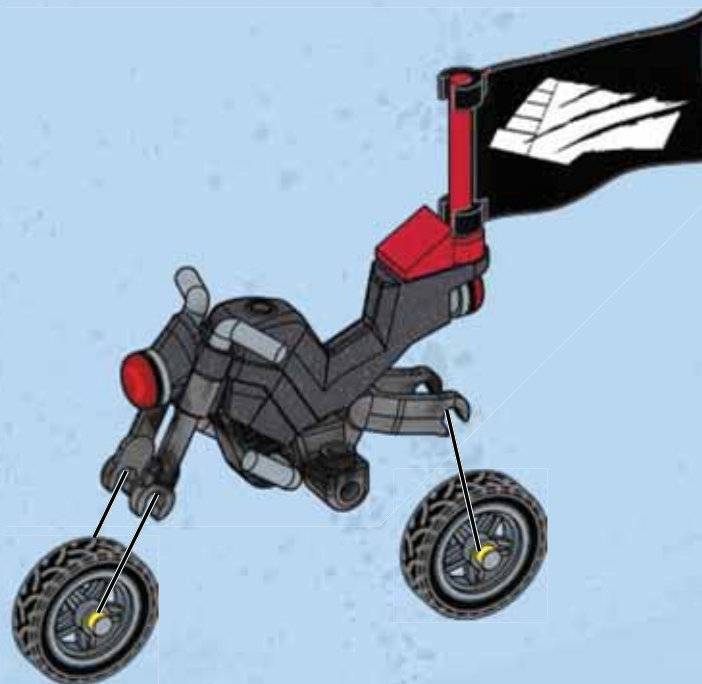

21



1x

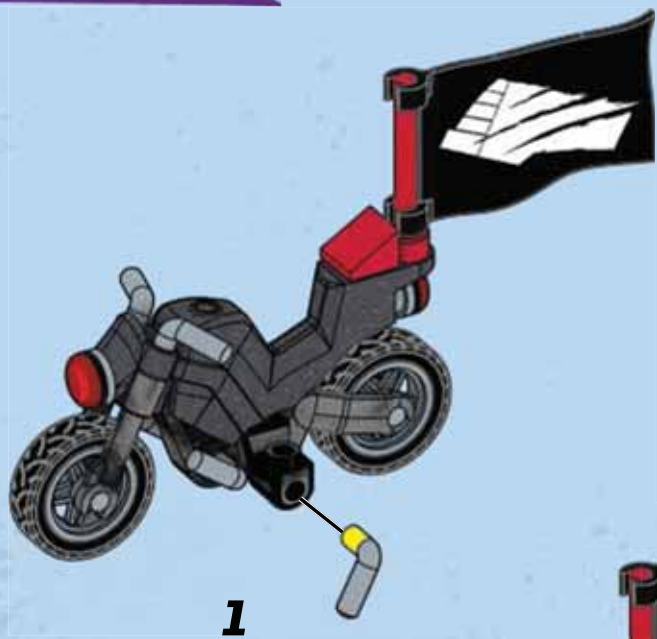

1

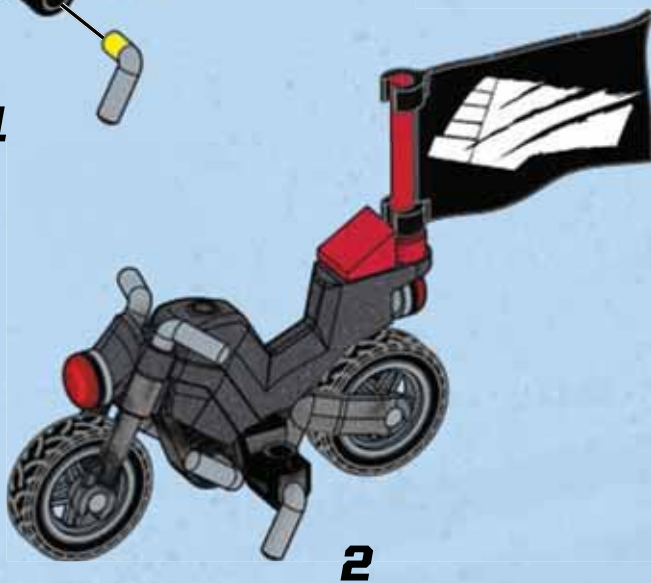

2

22



1x



1x



1x

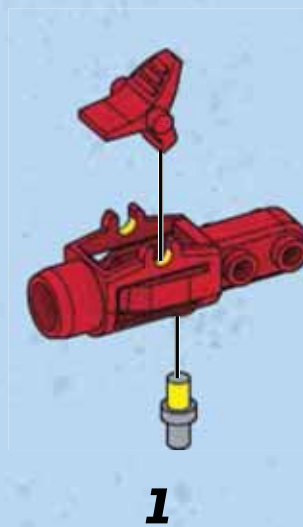

1



2



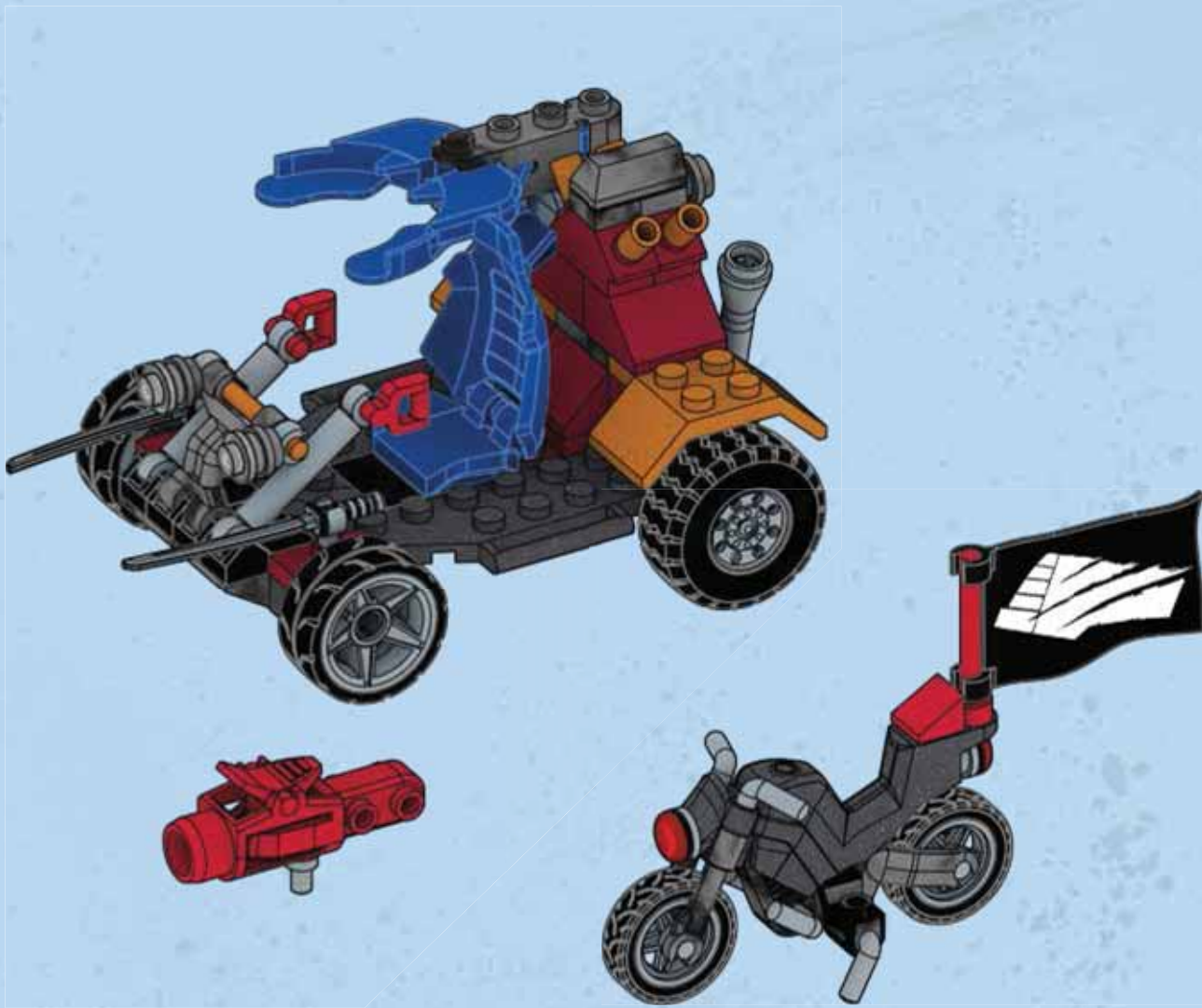



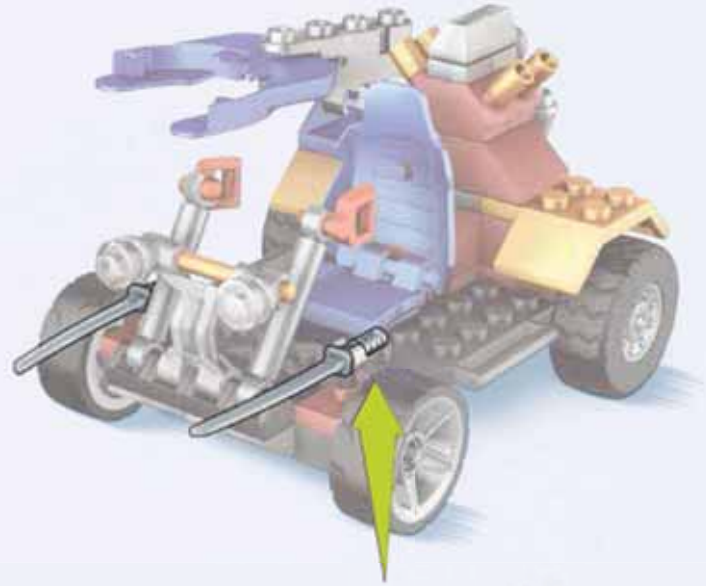

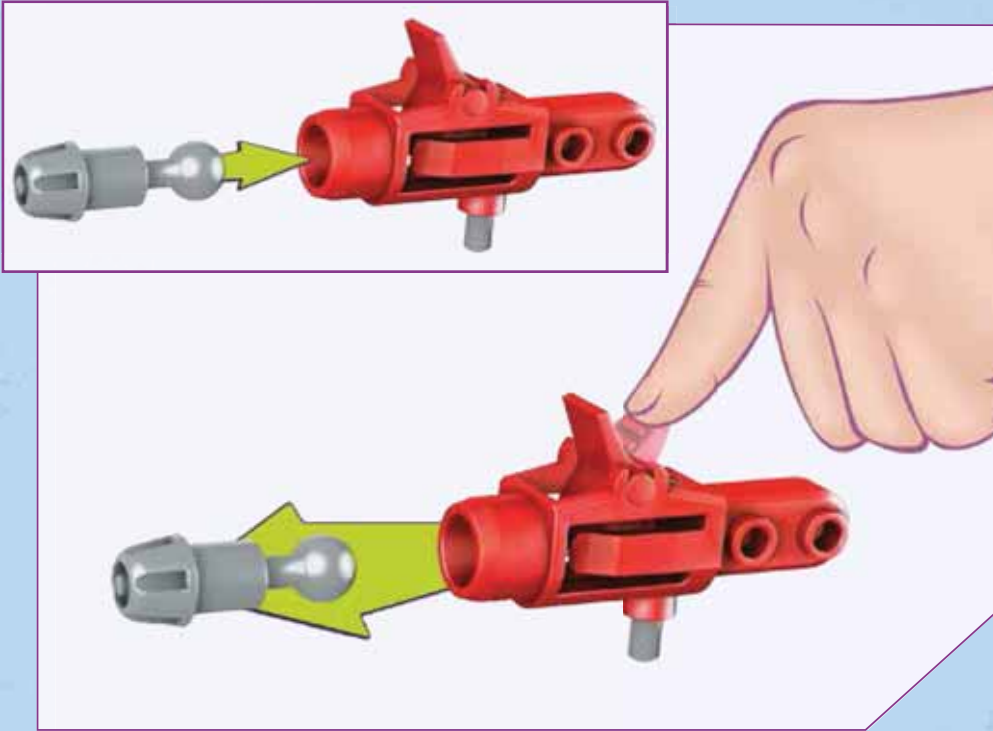

Warning: Do not aim at eyes or face. Only use projectiles supplied with this toy. Do not fire at point blank range.

Attention : Ne pas viser les yeux ou le visage. Ne pas utiliser d'autres projectiles que ceux fournis avec ce jouet. Ne pas tirer à bout portant.

Advertencia: No apuntar hacia los ojos o la cara. Utilizar exclusivamente los proyectiles suministrados con este juguete. No disparar a quemarropa.

Atenção: Não apontar em direção aos olhos ou ao rosto. Usar apenas os projéteis fornecidos com este brinquedo. Não disparar à queima-roupa.

Avvertenza: Non mirare agli occhi o al viso. Usare solo i proiettili forniti con il giocattolo. Non sparare a distanza ravvicinata.

Achtung: Nicht auf Augen oder Gesicht zielen. Nur die zu diesem Spielzeug gehörenden Projektile verwenden. Nicht auf Menschen oder Tiere oder aus nächster Nähe zielen.

Ostrzeżenie: Nie celuj w oczy i twarz. Nie strzelaj pociskami innymi niż dostarczone z zabawką. Nie strzelaj z bliska.

Waarschuwing: niet op ogen of gezicht richten. Gebruik uitsluitend de bijgeleverde projectielen. Niet van te dichtbij afschieten.

Предупреждение: Не направляйте в глаза или лицо. Используйте только снаряды, входящие в комплект. Не стреляйте со слишком близкого расстояния.

Advarsel: Sigt ikke mod øjne eller ansigt. Brug kun de projektiler, som følger med legetøjet. Skyd ikke direkte på personer eller ting.

Varning: Sikta inte mot ögon eller ansikte. Använd endast projektiler som medföljer leksaken. Fyra inte av på mycket nära håll.

Advarsel: Du må ikke sikte mot øyne eller ansikt. Bruk bare prosjektilene som følger med leken. Ikke skyt på noe på kloss hold.

Varoitus: Älä tähtää silmiin äläkä kasvoihin. Käytä ainoastaan tämän tuotteen mukana tulleita ammuksia. Älä ammu lähietäisyydeltä.

Προσοχή: Μην στοχεύετε στα μάτια ή στο πρόσωπο. Χρησιμοποιείτε μόνο τα βλήματα που περιλαμβάνονται. Μην στοχεύετε όταν δεν έχετε ορατότητα.

Uyarı: Göze veya yüze nişan almayın. Fırlatmak için yalnızca bu oyuncakla birlikte verilen objeleri kullanın. İnsanlara ve hayvanlara nişan almayın.

警告: 请勿对着眼睛或脸部发射。仅使用本玩具自带的抛射物。请勿近距离射击。

警告: 目や顔を狙わないでください。このおもちゃに同梱されている発射物のみ使用するようになしてください。到達可能な距離内で火を燃やさないでください。

تحذير: يجب عدم التصويب باتجاه العينين أو الوجه. يجب استخدام المقذوفات المزودة مع هذه اللعبة فقط. يجب عدم الإطلاق من مدى قريب.



TURTLE POWER | PODER DE TORTUGA NINJA | PODER DAS TARTARUGAS NINJA | МОС ŻÓŁWI | ЧЕРЕПАШЬЯ СИЛА | ΧΕΛΩΝΟ-ΔΥΝΑΜΗ | KARLUMBAĞA GÜCÜ

قوة السلاحف



SWIPING ACTION!
ACTION LATÉRALE!
¡ACCIÓN DESLIZANTE!
ATTACCA LATERALE!
GOŁPE!
¡ACCIÓN DESLIZANTE!
ATTACCA LATERALE!
COOLE ANGRIFFSACTION!
WYPROWADZA ATAK!
AANVALLEN! | КУЛАЧНЫЙ БОЙ!
ПАНГМА! | VUR!
إحركة العصف

DPF64



ZIPLINE ACTION!
ACTION SUR FILIN!
¡ACCIÓN DE CUERDA DE ESCAPE!
ANDA DE SLIDE!
AZIONE ECCLET!
SEIL-AKTION! | TYROLKA!
ZIPLIJNASTIE! | СКОРОСТНОЙ СПУСК!
ΚΑΤΑΒΑΣΗ! | TEREĐEN KAY!
إحركة حبل التوصيل

DMX52



SLASHING ACTION! | ACTION DE FRAPPE! | ¡ACCIÓN DE ATAQUE!
MOVIMIENTOS DE BRAÇOS!
AZIONE DEVASTANTE!
SCHLAG-ACTION! | CIĘCIE! | WAT EEN ACTIE! | ФУНКЦИЯ УДАРОВ!
ΣΟΥΠΕΡ ΔΡΑΣΗ! | NUNÇAKUNU SALLAI
إحركة الضرب

DMX51
DMX55



DOUBLE SLASHING ACTION!
ACTION DOUBLE FRAPPE!
¡ACCIÓN DE DOBLE ATAQUE!
DUPLO ATAQUE!
DOPPIA AZIONE DEVASTANTE!
DOPPELTE SCHLAG-ACTION!
PODWÓJNE CIĘCIE! | ΔΙΠΛΗ ΔΡΑΣΗ!
ДВОЙНЫЕ УДАРЫ! | ΔΙΠΛΗ ΔΡΑΣΗ!
ÇİFTE NUNÇAKULARINI SALLAI
إحركة الضرب المزدوجة

DMX54



YOU CAN COLLECT THEM ALL!
 À COLLECTIONNER! | COLECCIONALOS
 TODOS! | COLEZIONE TODOS!
 COLLEZIONALI TUTTI! | DU KANNST SIE
 ALLE SAMMELN! | MOŻESZ ZEBRAĆ JE
 WSZYSTKIE! | VERZAMEL ZE ALLEMAAL!
 ТЫ МОЖЕШЬ СОБРАТЬ ИХ ВСЕХ! | ΣΥΛΛΟΓΗ
 ΗΕΨΙΝΙ ΒΙΡΙΚΤΙΡΙ! | يمكنك جمعها كلها!



DONNIE

DMX37



MIKEY

DMX38



RAPH

DMX54



SHREDDER

DMX54



FOOT SOLDIER

DMX55



LEO

DMX55



TIGER CLAW

DMX55



RAPH

DMX21
F0865



DONNIE

DMX21
F0865



PURPLE DRAGON

DMX21
F0865



LEO

DMX21
F0865



MASTER SPLINTER

DMX21
F0865



MIKEY

DMX21
F0865



SLASH

DMX21
F0865

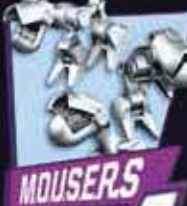

MOUSERS

DMX21
F0865



LEO

DPF59



RAPH

DPF60



DONNIE

DPF61



LEO

DPF62



RAPH

DPF64



RAHZAR

DPF64



KRAANGROID

DPF66



KRAANGROID

DPF66



MIKEY

DPF66



LEO

DRV34



APRIL

DMX21
F0865



LEATHERHEAD

DMX21
F0865



KRAANGROID

DMX21
F0865



MIKEY

DMX21
F0865



DONNIE

DMX21
F0865



RAPH

DMX21
F0865



LEO

DMX21
F0865



MIKEY

DXV05



RAPH

DXV06



DONNIE

DXV12



MOUSER

DXV12



MIKEY

DXV13



ICE CREAM KITTY

DXV13



RAPH

DXV14



CAPTAIN MOZAR

DXV14



KRAANGROID

DXV14



LEO

DXV15



BEBOP

DXV15



MIKEY

DXV74



ROCKSTEADY

DXV74



RAPH

DYV38

COLLECT & CONNECT! COLLECTIONNE-LES ET COMBINE-LES!
 ¡COLECCIONA Y CONECTA! COLECCIONA E UNE! COLLEZIONA
 E COLLEGA! ZUM SAMMELN UND VERBINDEN! ZBIERAJ I
 ŁĄCZ! VERZAMEL & COMBINEER! СОБИРАЙ И СОЕДИНЯЙ!
 ΚΑΝΤΕ ΣΟΥΠΕΡ ΣΥΛΛΟΓΗ & ΕΝΩΣΤΕ! HEPSİNİ BİRİKTİR VE
 BİRLEŞTİR! اجمع ووصل!



Each sold separately and subject to availability. / Tous vendus séparément. Certains produits peuvent ne pas être commercialisés. / Se venden por separado y están sujetos a disponibilidad. / Vendidos em separado e sujeitos à disponibilidade. / Ognuno in vendita separatamente secondo disponibilità. / Alle Artikel separat erhältlich. Einige Artikel werden nicht in allen Ländern vertrieben. / Sprzedawane oddzielnie w zależności od dostępności. / Per stuk verkrijgbaar en niet overall leverbaar. / Каждый продукт продается отдельно, в зависимости от наличия. / Sælges separat og så længe lager haves. / Alla delar säljs separat så långt lagret räcker. / Hver leke selges separat så langt lageret rekker. / Jokainen myydään erikseen, saatavuus voi vaihdella. / Το καθένα πωλείται ξεχωριστά και ανάλογα με τη διαθεσιμότητα. / Her biri ayrı ayrı ve stoklara bağlı olarak satılır. / 每件单独出售，并且视库存情况而定。それぞれ在庫状況に従って個別に販売されます。 / تبايع كل منها على حدة وتخضع لتوفرها.

©2016, MEGA Brands Inc. &™ MEGA Brands Inc. CONSTRUX™ is owned by Mattel and used under license. CONSTRUX™ appartient à Mattel et est utilisée sous licence. Printed in Canada D-DPW80-CP02

play.megaconstrux.com