

# HALO



UNSC Spade Rush | Mission Spade UNSC  
Ataque de espadas UNSC | Ataque Spade UNSC | UNSC Pojazd Spade

**MEGA  
BLOKS**

INTERCHANGEABLE ARMOR SYSTEM  
SYSTEME D'ARMURE INTERCHANGEABLE  
SISTEMA DE ARMADURA INTERCAMBIABLE  
SISTEMA DE ARMADURA INTERCAMBIAVEL



SISTEMA DI ARMATURA INTERCAMBIABILE  
AUSTAUSCHBARE PANZERUNGSSYSTEM  
ZAMIENNY SYSTEM UZDROJENIA  
WERWISSELBAR WAPENRUSTINGSYSTEM  
СМЕННАЯ СИСТЕМА БРОНИ



UNSC Spartan EVA



UNSC Spartan Operator

1x   
AM74400APD

1x   
AM74401APD

2x   
MA17003MY

2x   
AM18560APD

10x   
AM72534F

2x   
MA12251APD

2x   
MA03328AJK

8x   
MA03328APD

4x   
MA1140F

4x   
MA17127F

2x   
MA07629APD

2x   
MA04428APD

5x   
MA09198F

2x   
M09393ZD

5x   
MA09393AJK

11x   
MA09393APD

2x   
MA09393F

1x   
AM18221APD

2x   
MA09835AGV

4x   
MA09835APD

6x   
AM19165F

3x   
MA07228F

4x   
MA1417APD

1x   
MA1133F

4x   
MA09013AJK

4x   
MA09013APD

3x   
MA09013F

4x   
MA15484APD

2x   
MA17153APD

1x   
AM19009AGV

2x   
AM18525F

2x   
MA03773APD

1x   
AM18220F

1x   
AM17019F

2x   
AM19162AGV

1x   
MA1154F

1x   
MA03772F

1x   
MA09033APD

1x   
MA1141F

1x   
AM72651AGV

1x   
AM18222F

2x   
MA09931AGV

2x   
MA16384F

4x   
MA09593APD

2x   
MA09593AJK

1x   
MA09292APD

2x   
MA08480AJK

2x   
MA18658APD

1x   
AM72653AJK

1x   
AM73257AJK

1x   
AM72652AGV

1x   
AM19163F

1x   
AM19164F

4x   
MA73472F

1x   
AM19231AJK

1x   
AM19230AJK

2x   
AM19161AJK

2x   
AS-DPW93-01

2x   
AS-DPW93-02

1x   
AM19166APD

1x   
AM19167APD

2x   
AM18241MY





2x  
MA09493AJK



2x  
MA09493F



1x  
MA08483APD



1x  
MA1172F



1x  
MA1480AJK



3x  
MA1480APD



1x  
MA08483F



2x  
AM17069F



1x  
MA74678APD



1x  
AM18217F



1x  
FIG-DPW93-A



1x  
FIG-DPW93-B



1x  
AM18539F



1x  
AM17623JZ



2x  
AM76357ANW



Please read these instructions carefully before first use and keep them for future reference.

Il est recommandé de lire attentivement ce feuillet avant la première utilisation et de le conserver pour référence future.

Leer estas instrucciones cuidadosamente antes de la primera utilización y guardarlas para referencia futura.

Leia as instruções antes do primeiro uso e guarde-as para futura referência.

Leggere le istruzioni prima di cominciare ad usare il gioco e conservarle per referenze future.

Die Gebrauchsanleitung bitte durchlesen und aufbewahren.

Proszę uważnie przeczytać instrukcję obsługi przed pierwszym użyciem, a następnie zachować ją na przyszłość.

Wij raden u aan deze handleiding zorgvuldig te lezen en te bewaren voor eventuele raadpleging op een later tijdstip.

Внимательно прочитайте инструкцию перед первым использованием и сохраните ее для дальнейшего использования.

Vær venlig at læse disse instruktioner omhyggeligt inden ibrugtagen og opbevar dem til fremtidigt brug.

Läs noggrant igenom dessa instruktioner innan du använder produkten för första gången och spara dem för ev. framtida frågor.

Les disse instruksjonene nøye før første gangs bruk, og ta vare på dem for fremtidige oppslag.

Lue nämä ohjeet huolellisesti ennen ensimmäistä käyttöä ja säilytä ne myöhempää tarvetta varten.

Διαβάστε αυτές τις οδηγίες προσεκτικά πριν χρησιμοποιήσετε το προϊόν για πρώτη φορά και φυλάξτε τις για μελλοντική αναφορά.

يرجى قراءة هذه التعليمات بدقة قبل البدء بالاستعمال والاحتفاظ بها كمرجع للمستقبل

请在初次使用前仔细阅读这些指示，并保留它们以便未来参考。

初めてご使用になる前に、この説明書をよくお読みください。また、本書は将来いつでも参照できるように保管してください。

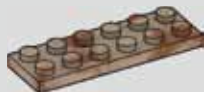
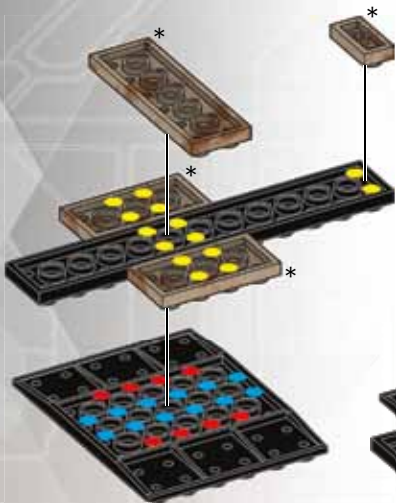

**1****1X****2X****1X****1X****1X**

\* Place temporary pieces  
 Placez les pièces temporaires  
 Colocar piezas temporales  
 Coloque peças temporárias  
 Installare i pezzi temporanei  
 Vorübergehende Teile platzieren  
 Umieścić elementy tymczasowe.  
 Plaats tijdelijke bouwstenen  
 Установите временные детали  
 Placer midlertidige stykker.  
 Placera temporära delar  
 Plasser midlertidige deler  
 Aseta väliaikaiset osat  
 Τοποθέτηση προσωρινών κομμάτιων  
 ضع القطع المؤقتة  
 放置臨時件  
 暫定ピースを配置してください

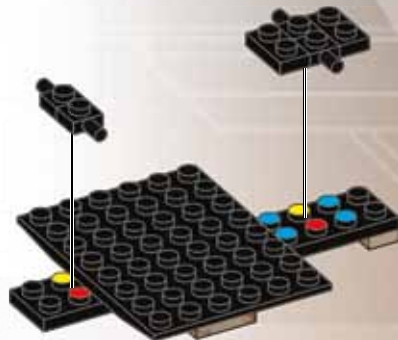
**1****4X****2X****6****1****2**

3



1X



1X

4



2X



1X



2X

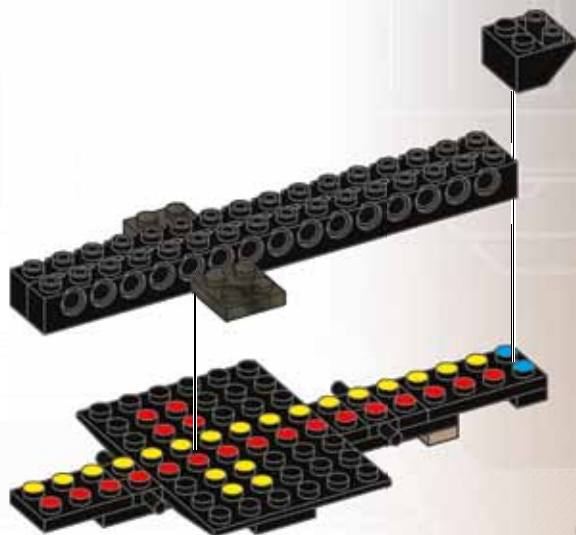

5



10X

4X

X2



1

2

6



2X



2X



1

2

X2

8

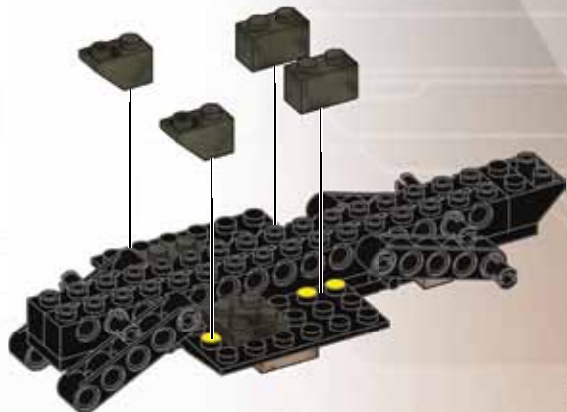



7



4X

2X

2X

8



2X

2X

2X

2X



1



2

X2

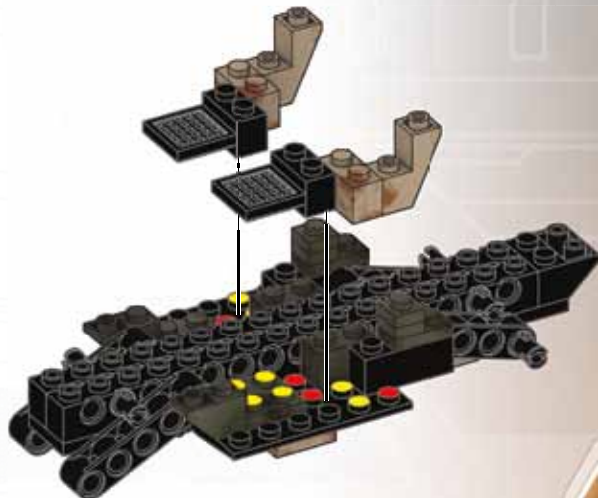

9



2X



2X



2X



2X



X2

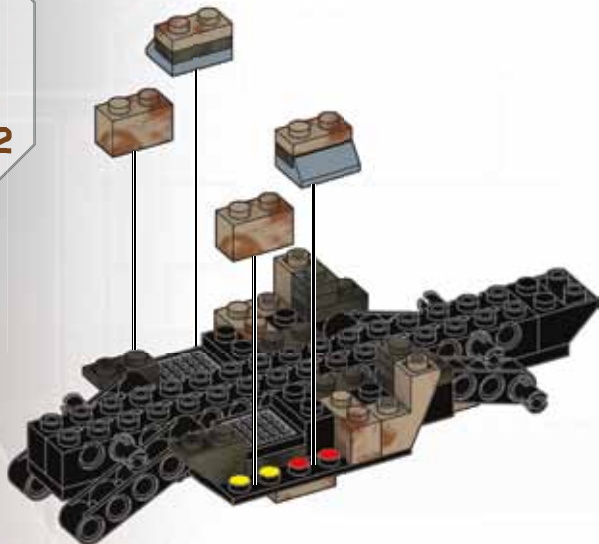

10



2X



1X

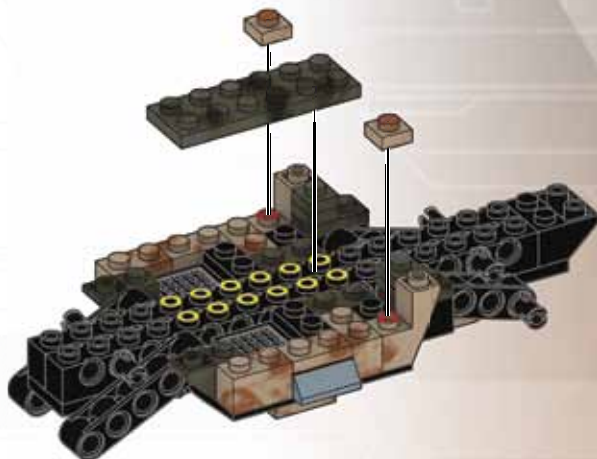

10

11



2X

2X

4X

2X

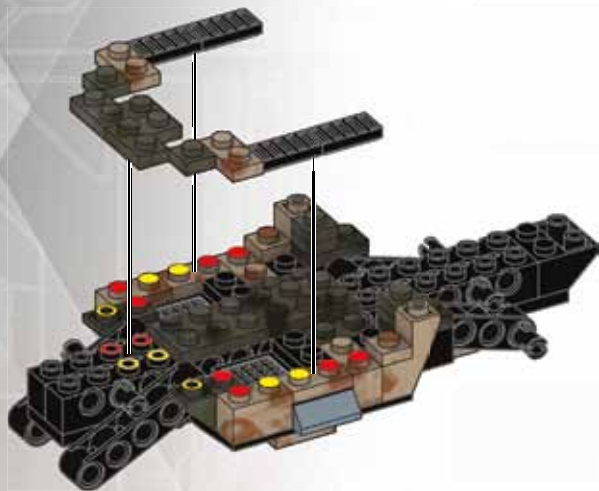

12



2X

1X

1X

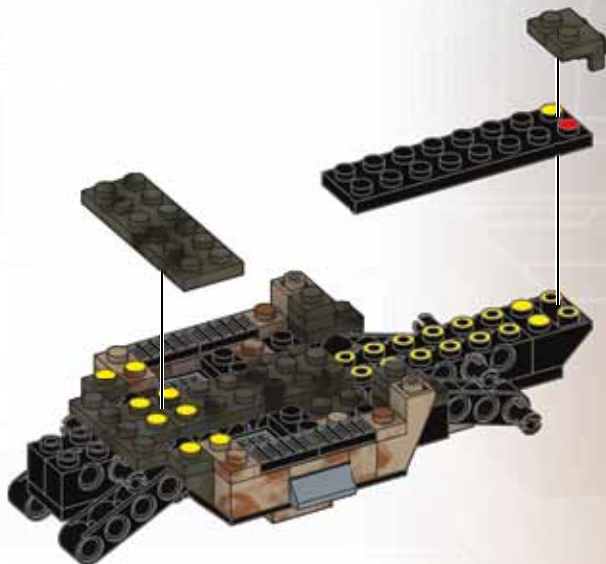

13

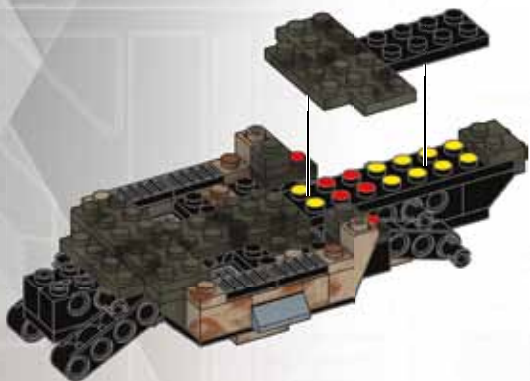

14

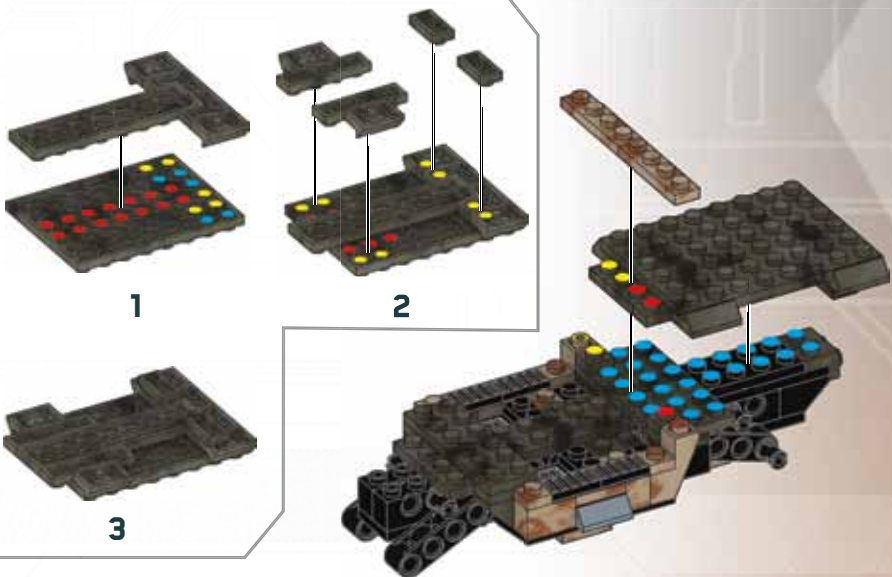

12



# 15



4X

1X

2X

1X

1X

# 16



2X

2X

1X

1X

1X



1

2



1

2

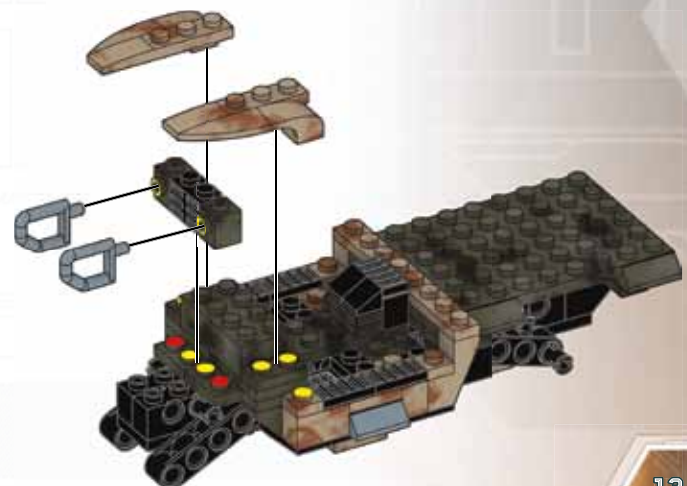
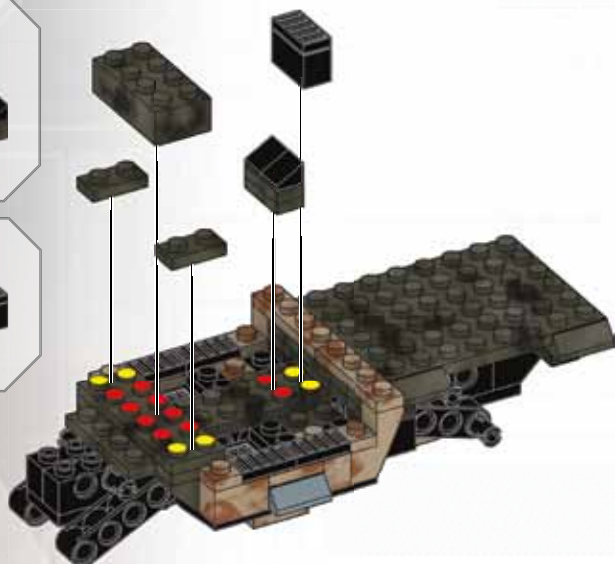

17

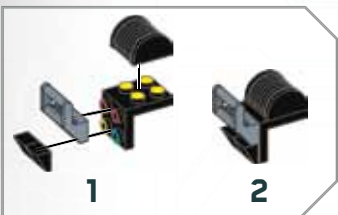

18

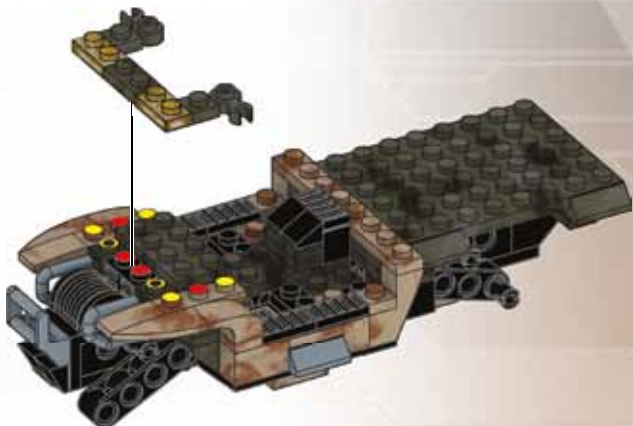
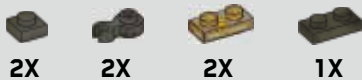

14

19



1X

1X

1X



1



2



20

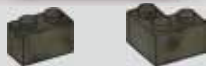

2X

2X



21



2X



2X



2X



X2

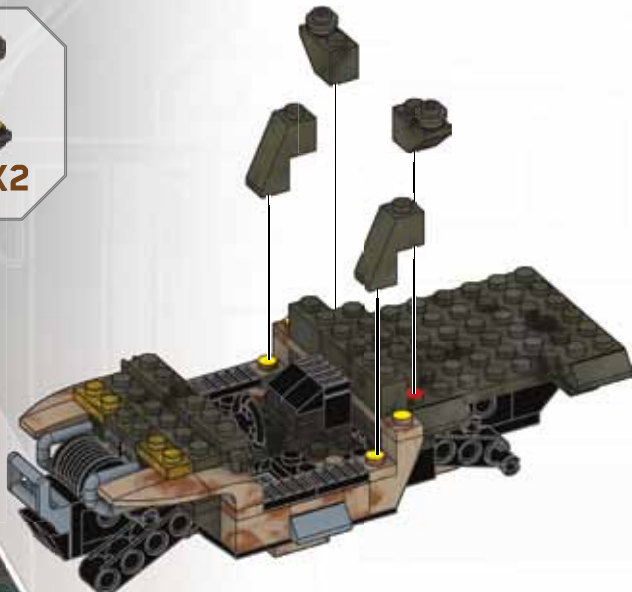

22



2X



2X



X2

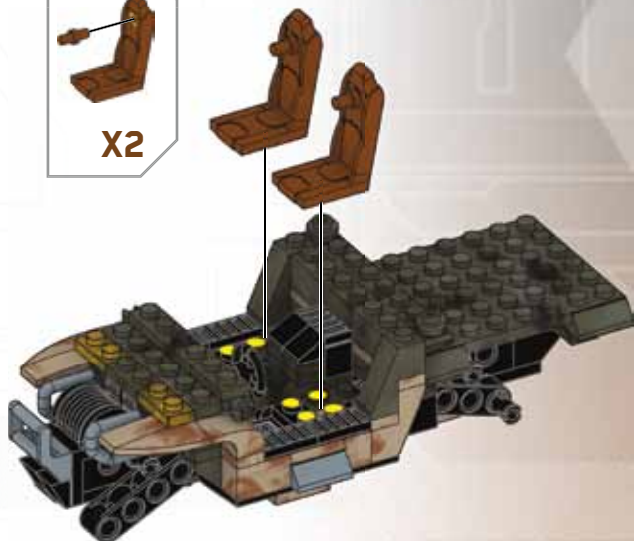



23



6X



2X



1X



1X

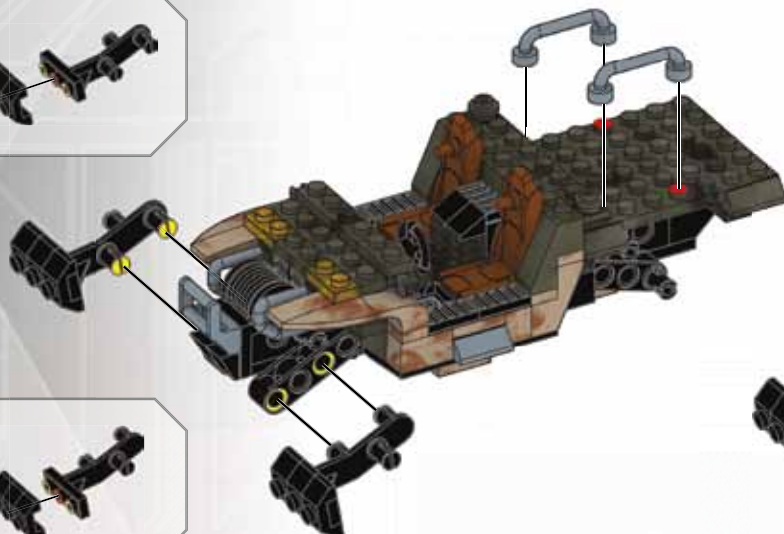

1

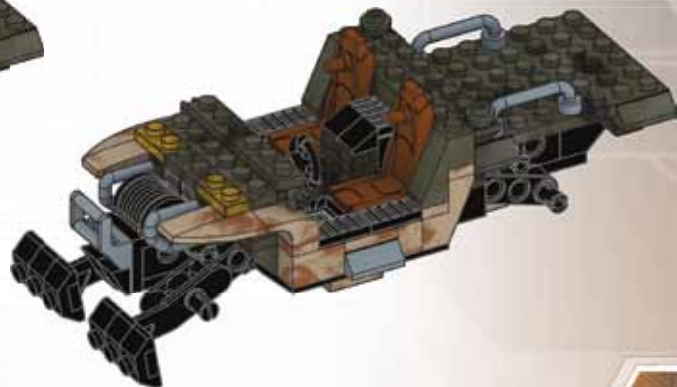

2

17

24



3X



1X

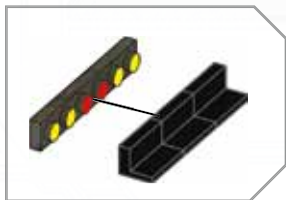

1



2

18

25



1X



1X



2X



1X



1X



1X



26



1X



1X



1X



1X



1



2



1



2

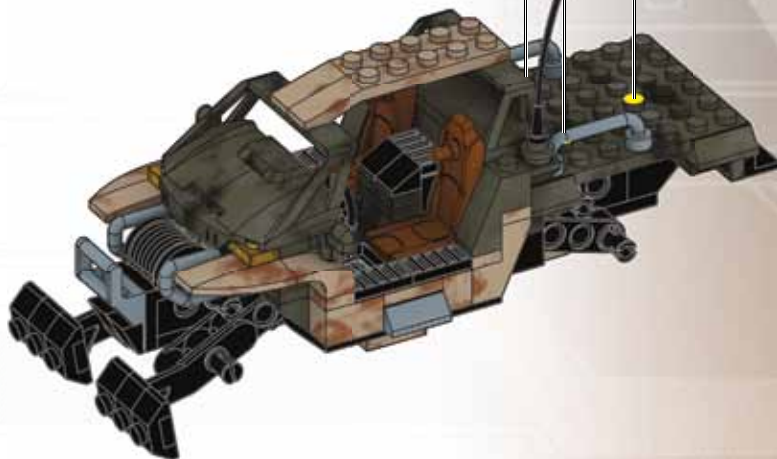



27



2X



2X



1



2

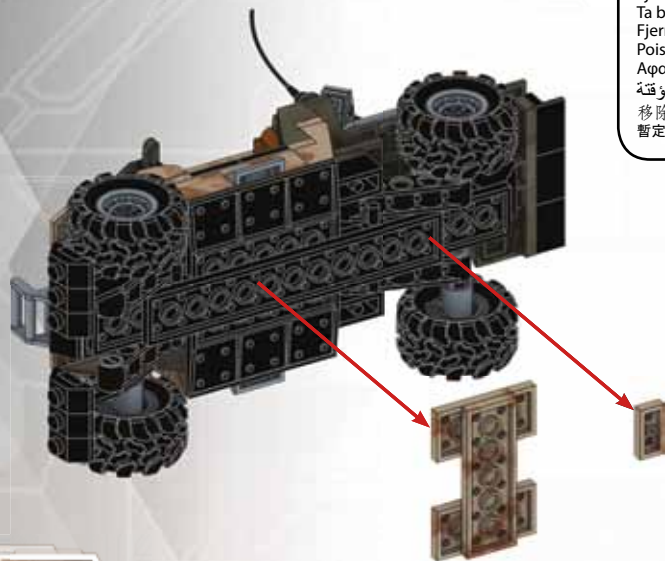

1

Remove temporary pieces  
 Retirez les pièces temporaires  
 Retirar piezas temporales  
 Remova peças temporárias  
 Rimuovere i pezzi temporanei  
 Vorübergehende Teile entfernen  
 Usunąć elementy tymczasowe.  
 Verwijder tijdelijke bouwstenen  
 Снимите временные детали  
 Fjern midlertidige stykker.  
 Ta bort temporära delar  
 Fjern midlertidige deler  
 Poista väliaikaiset osat  
 Αφαίρεση προσωρινών κομματιών  
 انزع القطع المؤقتة  
 移除临时件  
 暂定ピースを外してください

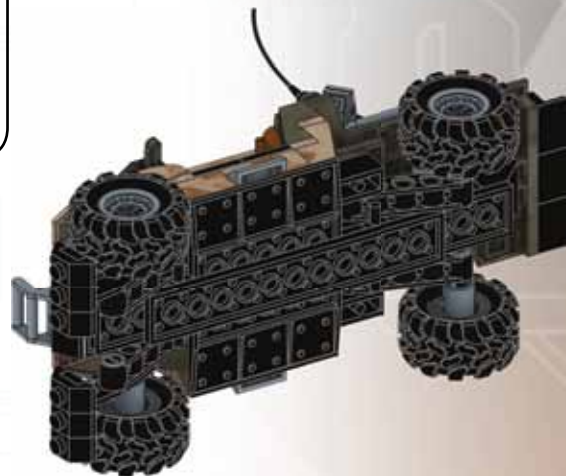

2



# HALO

## MEGA BLOKS

INTERCHANGEABLE ARMOR SYSTEM  
SYSTEME D'ARMURE INTERCHANGEABLE  
SISTEMA DE ARMADURA INTERCAMBIABLE  
SISTEMA DE ARMADURA INTERCAMBIAVEL



SISTEMA DI ARMATURA INTERCAMBIABILE  
AUSTAUSCHBARE PANZERUNGSSYSTEM  
ZAMIENNY SYSTEM UZBROJENIA  
WERWISSELBAR WAPENUSTELINGSSYSTEM  
СМЕЖНАЯ СИСТЕМА БРОНЯ



UNSC Spartan EVA



UNSC Spartan Operator



DPJ90



DPJ88



DPJ91



Spartan Laser



MA37 Assault Rifle

COLLECT THEM ALL!  
COLLECTIONNEZ-LES TOUS !  
¡COLECCIONALOS TODOS!  
COLECCIONE TODOS ELES!  
COLLEZIONALI TUTTI!  
SAMMELE SIE ALLE!  
ZBIERZ JE WSZYSTKIE!  
VERZAMEL ZE ALLEMAAL!  
СОБРАТЬ ИХ ВСЕХ!

[HALO.MEGABLOKS.COM](http://HALO.MEGABLOKS.COM)

Each sold separately and subject to availability. / Tous vendus séparément. Certains produits peuvent ne pas être commercialisés. / Se venden por separado y están sujetos a disponibilidad. / Vendidos em separado e sujeitos à disponibilidade. / Ognuno in vendita separatamente secondo disponibilità. / Alle Artikel separat erhältlich. Einige Artikel werden nicht in allen Ländern vertrieben. / Sprzedawane oddzielnie w zależności od dostępności. / Per stuk verkrijgbaar en niet overal leverbaar. / Каждый продукт продается отдельно, в зависимости от наличия. / Sælges separat og så længe lager haves. / Alla delar säljs separat så långt lagret räcker. / Hver leke selges separat så langt lageret rekker. / Jokainen muuään erikseen, saatavuus voi vaihdella. / Το καθένα πωλείται ξεχωριστά και ανάλογα με τη διαθεσιμότητα. /

تباع كل منها على حدة وتخضع لتوفرها.  
每件单独出售，并且视库存情况而定。  
それぞれ在庫状況に従って個別に販売されます。