

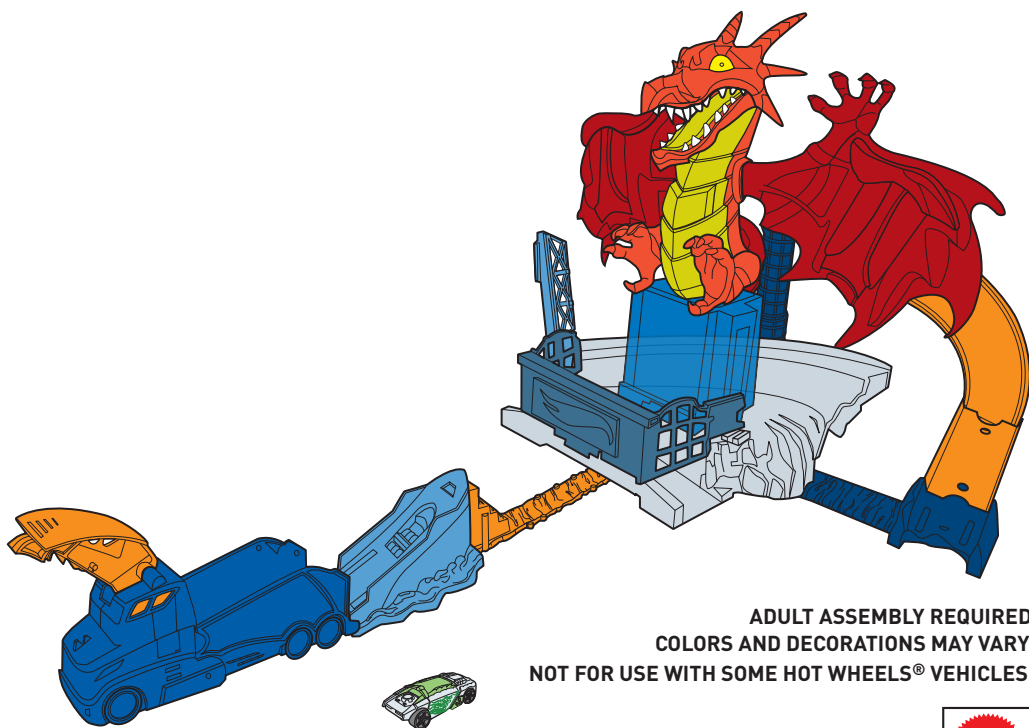

DRAGON BLAST™



ADULT ASSEMBLY REQUIRED
COLORS AND DECORATIONS MAY VARY.
NOT FOR USE WITH SOME HOT WHEELS® VEHICLES.

4+

service.mattel.com
HOTWHEELS.COM



FFF57_0970-G1
1101318757_DOM

PLEASE KEEP THESE INSTRUCTIONS FOR FUTURE
REFERENCE AS THEY CONTAIN IMPORTANT INFORMATION.

CONTENTS

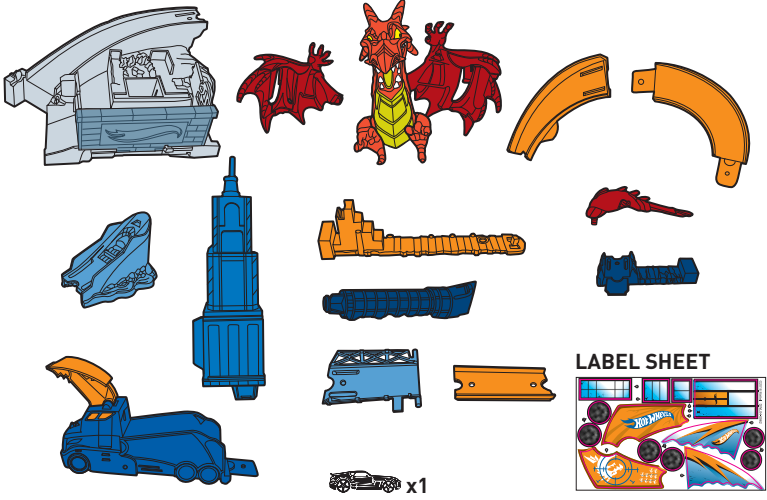

APPLY LABELS

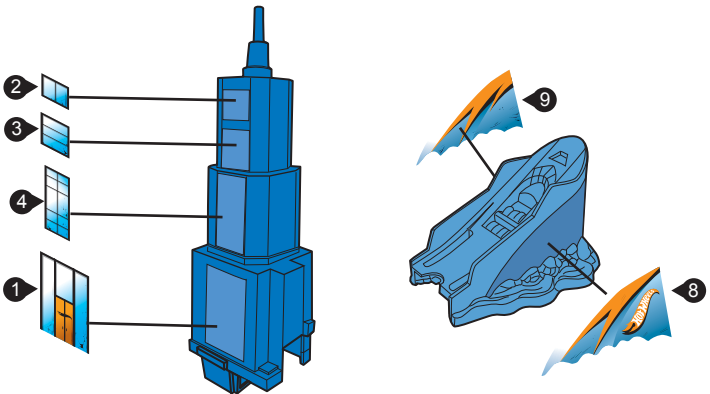
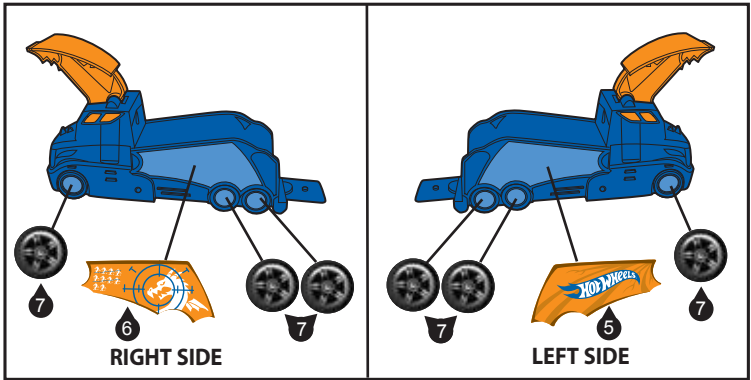

ASSEMBLY

1.

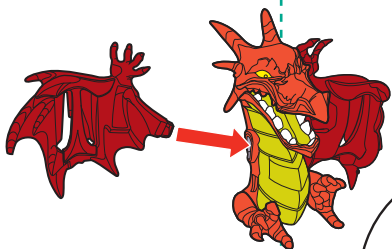

2.

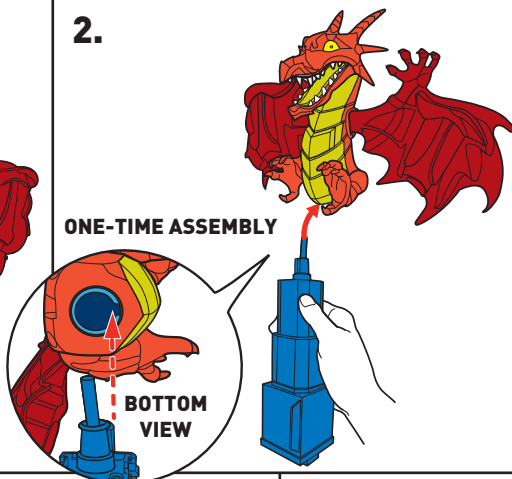

3.

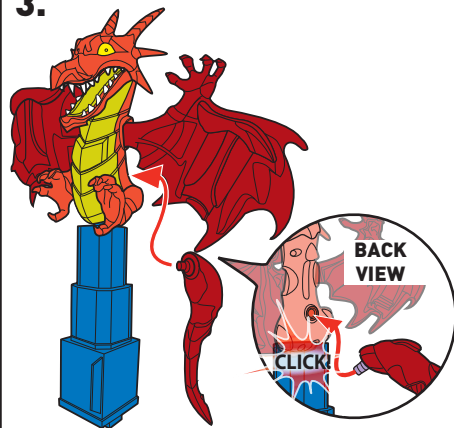

4.

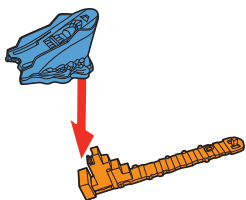

5.

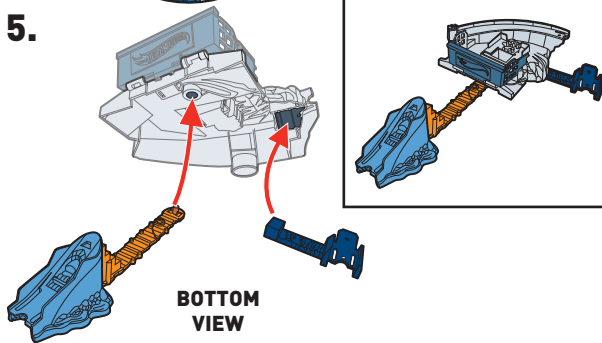

6.

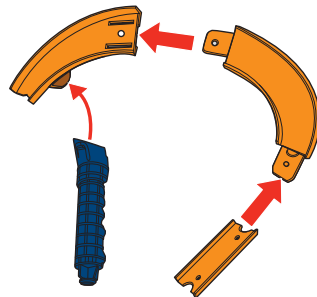

7.

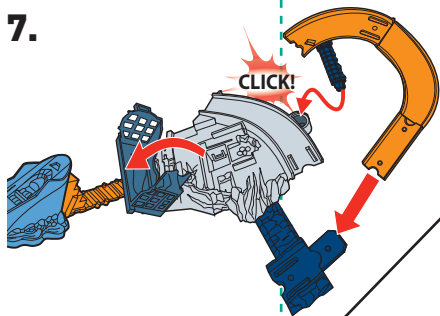

8.

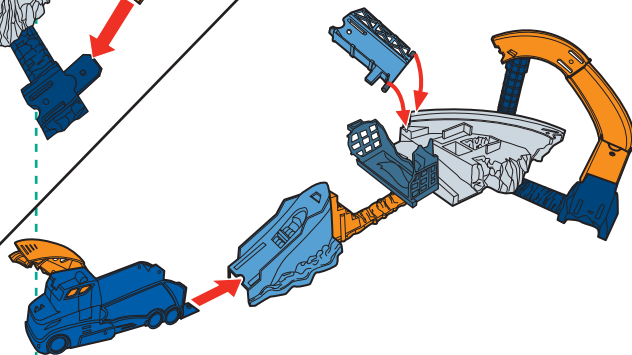

9.

ATTACH WITH DRAGON'S TAIL FACING FRONT.

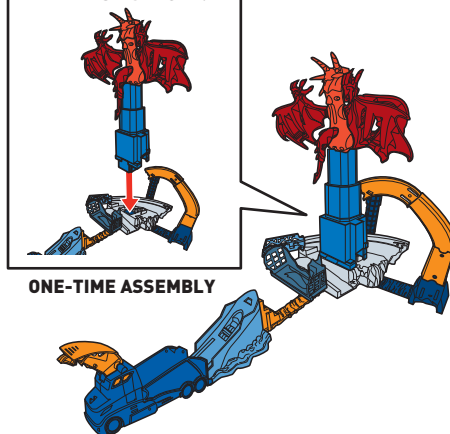

BEFORE YOU PLAY

1. ROTATE DRAGON UNTIL IT FACES THE FRONT AND LOCKS INTO PLACE.

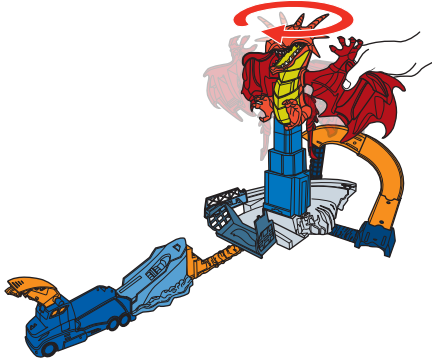

2. PUSH DRAGON DOWN.

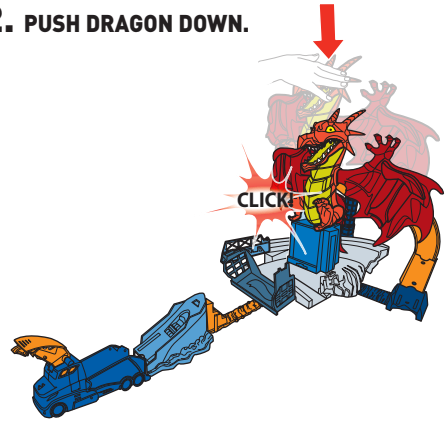

3. RAISE BRIDGE AND CLOSE DRAGON'S LAIR.

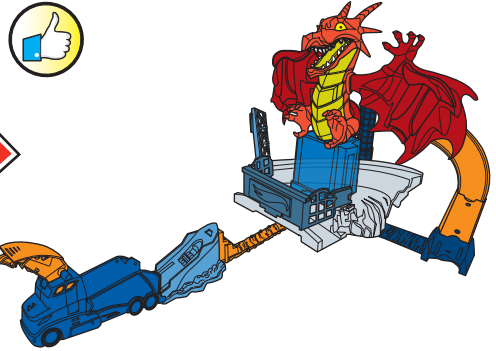
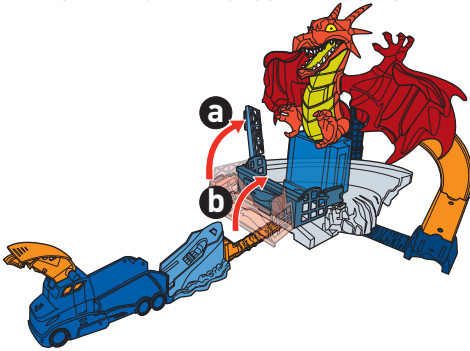

TO PLAY

1. LOAD IN YOUR CARS.

LOAD CAR INTO LAUNCHER.

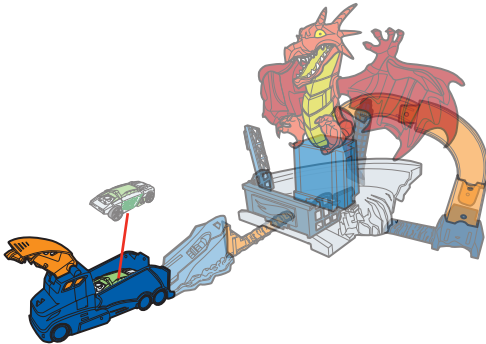

LOAD ADDITIONAL CARS INTO THE DRAGON'S CLAWS AND ONTO THE BRIDGE IN THE BACK.

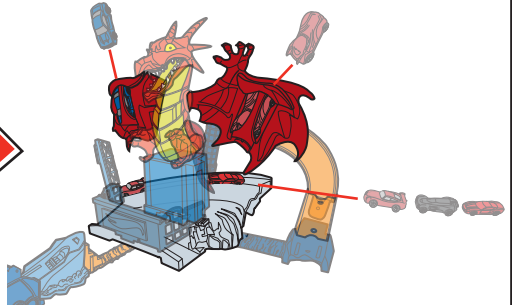

**1 VEHICLE INCLUDED.
ADDITIONAL VEHICLES SOLD SEPARATELY.**

TO PLAY (CONTD.)

- 2. MOVE LAUNCHER AND AIM FOR THE DRAGON'S CHEST! MISS AND YOU MIGHT GET CAPTURED!**

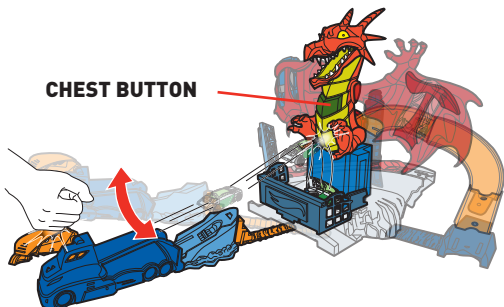

- 3. HIT THE DRAGON'S CHEST. ANGERED DRAGON SPRINGS TO LIFE AND ESCAPE BRIDGE LOWERS!**

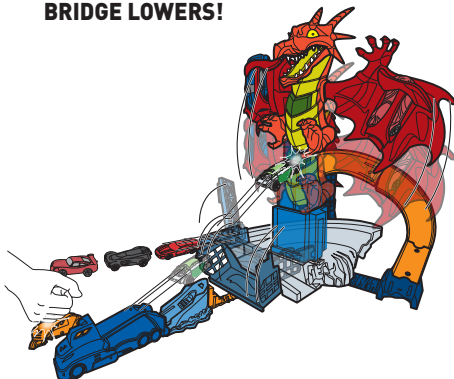

- 4. ATTACH LAUNCHER TO THE RESCUE RAMP.**

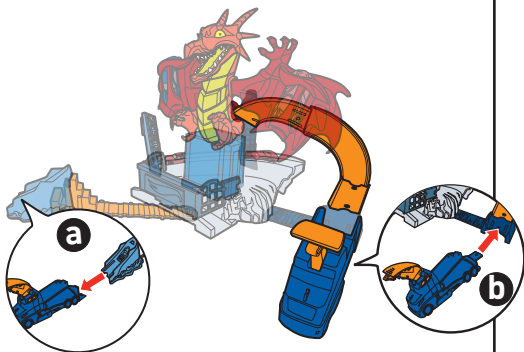

- 5. LAUNCH UP THE RESCUE RAMP. HIT TAIL TO DEFEAT THE DRAGON AND FREE THE CAPTURED CARS!**

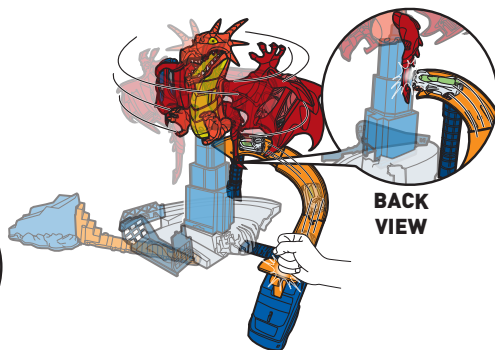

- 6. DEFEATED DRAGON SPINS & CRASHES TO THE GROUND!**

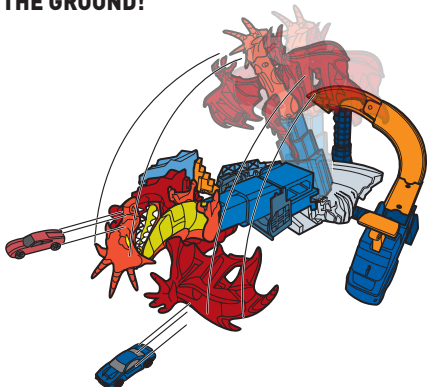

- 7. RAISE AND RESET DRAGON BY REPEATING THE STEPS IN BEFORE YOU PLAY.**

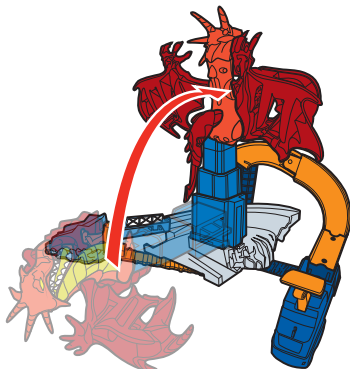

MORE WAYS TO PLAY

- 1. HERE'S AN EASY AND FAST WAY TO WAKE UP THE DRAGON! MOVE YOUR LAUNCHER AND ATTACH IT TO THE RESCUE RAMP. LAUNCH YOUR CAR!**

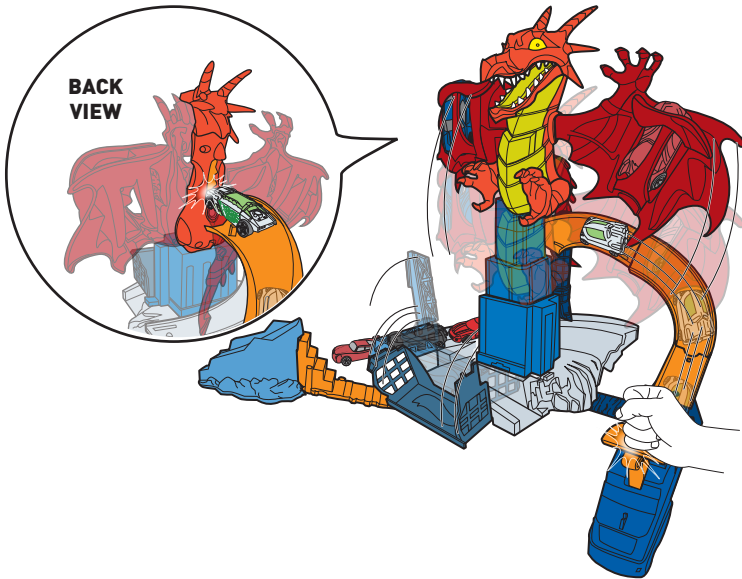

- 2. CAPTURE ANOTHER CAR IN THE DRAGON'S FOOT FOR A NEW CHALLENGE!**

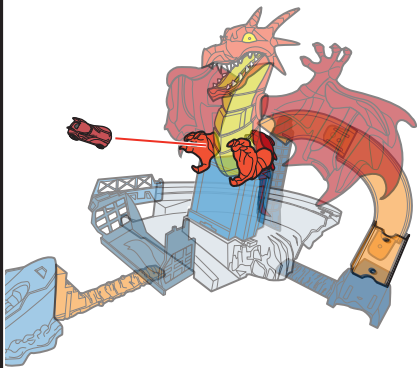

- 3. CONNECTS TO OTHER HOT WHEELS® SETS (SOLD SEPARATELY).**

