

# THOMAS & FRIENDS SUPER STATION

works with

MINIS

Adventures

TRACK MASTER  
MOTORIZED RAILWAY

WOODEN RAILWAY



Includes Thomas, Percy, James and Harold. Other engines sold separately and subject to availability. Does not work with My First Thomas engines.

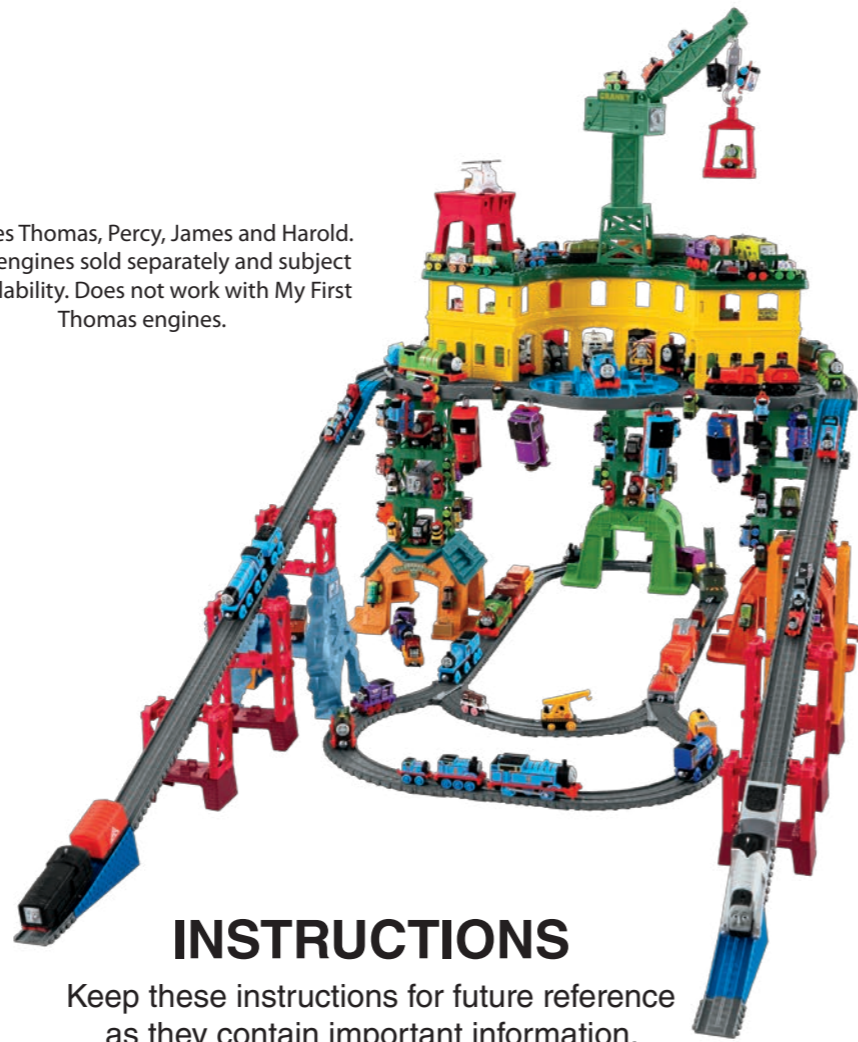

## INSTRUCTIONS

Keep these instructions for future reference as they contain important information.

Thomas the Tank Engine & Friends™



CREATED BY BRITT ALLCROFT

Based on the Railway Series by The Reverend W Awdry.  
©2017 Gullane (Thomas) Limited. Thomas the Tank Engine & Friends and Thomas & Friends are trademarks of Gullane (Thomas) Limited.  
©2017 HIT Entertainment Limited. HIT and the HIT logo are trademarks of HIT Entertainment Limited.

©2017 Mattel. All Rights Reserved. ® and ™ designate U.S. trademarks of Mattel, except as noted. **PRINTED IN CHINA.** Mattel East Asia Ltd., Room 503-09, North Tower, World Finance Centre, Harbour City, Tsimshatsui, HK, China. Tel.: (852) 3185-6500.

**CONSUMER ASSISTANCE**  
1-800-432-5437 (US & Canada)  
1300 135 312 (Australia)  
**service.fisher-price.com**

Fisher-Price, Inc., 636 Girard Avenue, East Aurora, NY 14052.  
Hearing-impaired consumers: 1-800-382-7470.

**Outside the United States:**  
Canada: Mattel Canada Inc., 6155 Freemont Blvd., Mississauga, Ontario L5R 3W2; www.service.mattel.com.  
Great Britain: Mattel UK Ltd, Vanwall Business Park, Maidenhead SL6 4UB. Helpline: 01628 500303. www.service.mattel.com/uk  
Mattel Europa B.V., Gondel 1, 1186 MJ Amstelveen, Nederland.  
Australia: Mattel Australia Pty. Ltd., 658 Church Street, Locked Bag #870, Richmond, Victoria 3121 Australia.  
New Zealand: 16-18 William Pickering Drive, Albany 1331, Auckland.  
SOUTH AFRICA: Mattel South Africa (PTY) LTD, Office 102 I3, 30 Melrose Boulevard, Johannesburg 2196.

**WARNING:**  
CHOKING HAZARD - Small parts.  
Not for children under 3 years.

**CAUTION:**  
To prevent entanglement,  
keep hair away from wheels.



Protect the environment by not disposing of this product or any batteries with household waste. This symbol indicates that this product shall not be treated as household waste. Check your local authority for recycling advice and facilities.

FGR22-0970-G2  
1101435661-DOM



FGR22

## HELPFUL HINTS



- **ONE-TIME SNAPS:** Assembly steps that are marked with a star are “one-time snaps”. Once these parts are put together, they cannot be taken apart.

- Track marking codes are found on the bottom of tracks and risers.

Note: Some engines may not work on this track set.

**ADULT ASSEMBLY REQUIRED.** No tools needed.

**INCLUDES TRACK ADAPTERS TO CONNECT TO TRACKMASTER™, WOODEN RAILWAY, AND ADVENTURES SETS.**

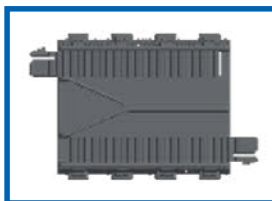

**ATM**  
(TrackMaster™)

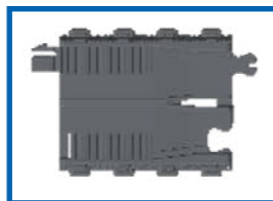

**AAdv**  
(Adventures)

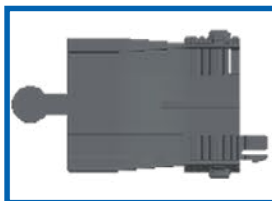

**AW1**  
(Wooden Railway)

## BATTERY INFORMATION

### BATTERY INSTALLATION

Access the battery compartment by unscrewing and separating the top half of the engine from the bottom half of the engine. Install the batteries as indicated inside the battery compartment. Re-assemble the two halves of the engine, re-insert the screw and tighten. If the product begins to malfunction, check the battery installation. You may need to reset the electronics by removing the batteries and reinstalling them. If the product continues to malfunction or no longer operates, remove the batteries from the toy and replace them with fresh batteries. Requires 2 “AAA” (LR03) batteries. For longer life use only alkaline batteries.

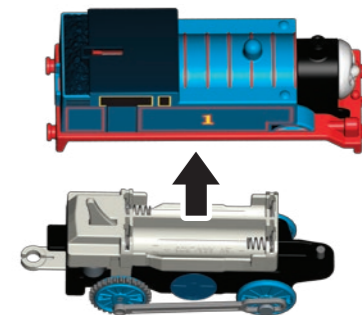
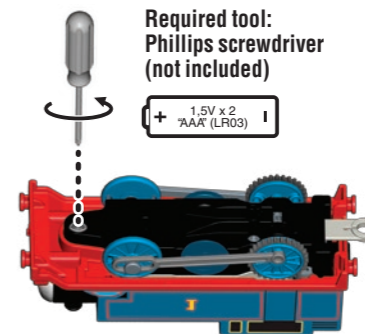

### BATTERY SAFETY INFORMATION

In exceptional circumstances batteries may leak fluids that can cause a chemical burn injury or ruin your product. To avoid battery leakage:

- Non-rechargeable batteries are not to be recharged.
- Rechargeable batteries are to be removed from the product before being charged.
- Rechargeable batteries are only to be charged under adult supervision.
- Do not mix alkaline, standard (carbon-zinc), or rechargeable batteries.
- Do not mix old and new batteries.
- Only batteries of the same or equivalent type as recommended are to be used.
- Batteries are to be inserted with the correct polarity.
- Exhausted batteries are to be removed from the product.
- The supply terminals are not to be short-circuited.
- Dispose of batteries safely.
- Do not dispose of this product in a fire. The batteries inside may explode or leak.

# WHAT'S INCLUDED

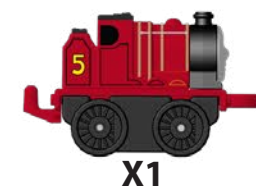
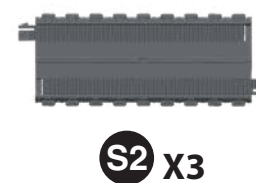
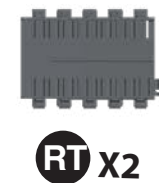
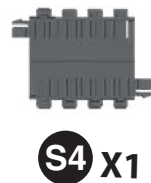
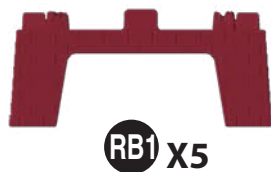
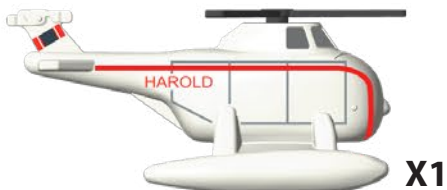
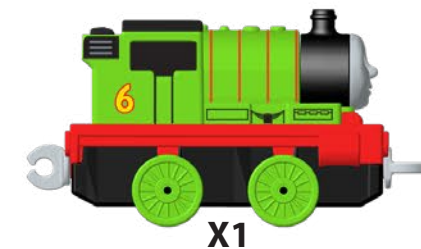
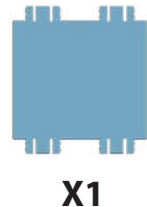
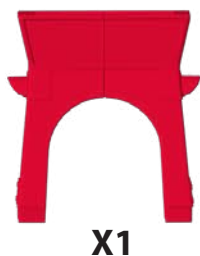
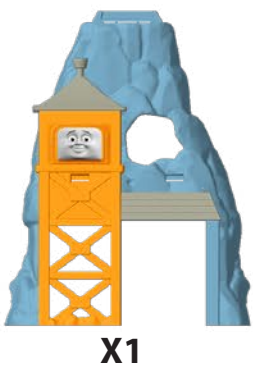
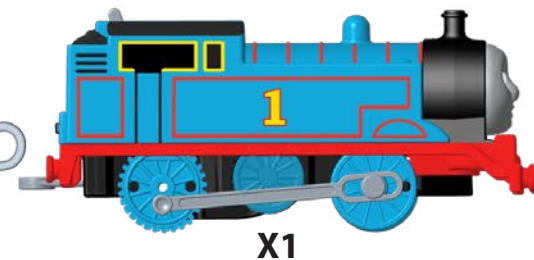
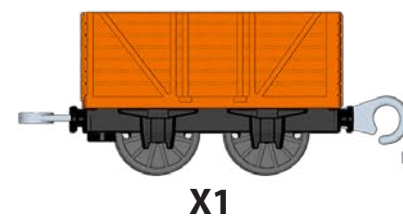
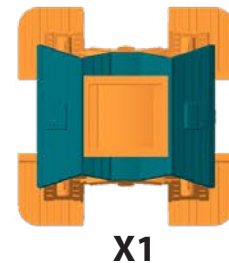
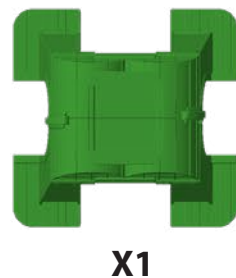
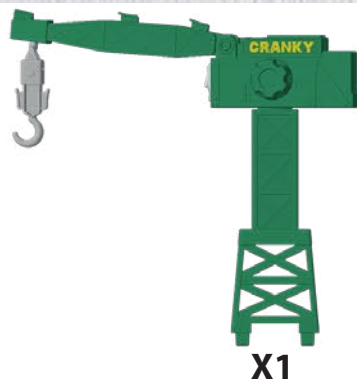
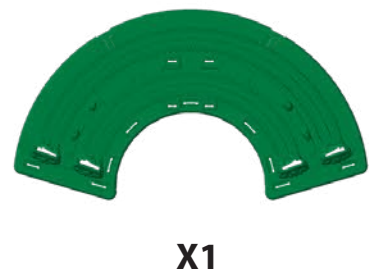
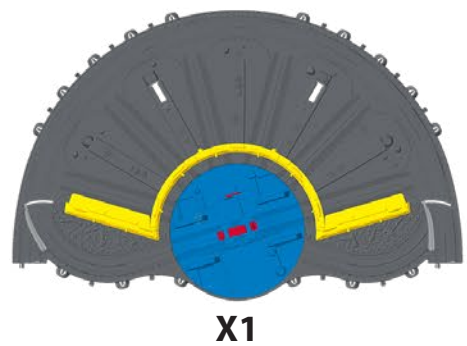

# ***LABEL PLACEMENT***

KNAPFORD STATION

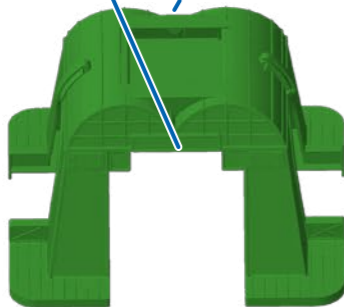

SODOR  
STEAMWORKS

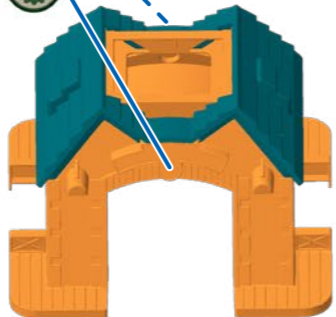

VICARSTOWN  
DIESELWORKS

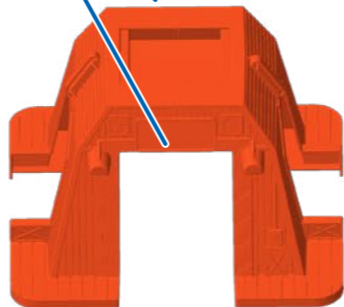

CRANKY

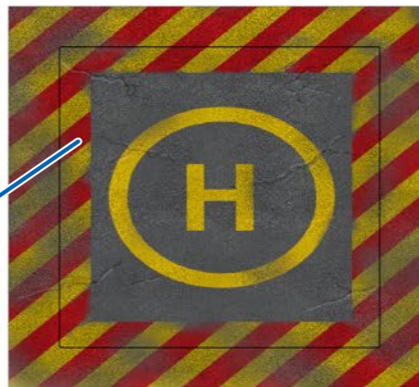
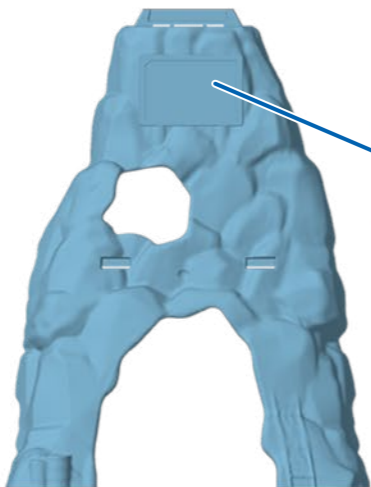
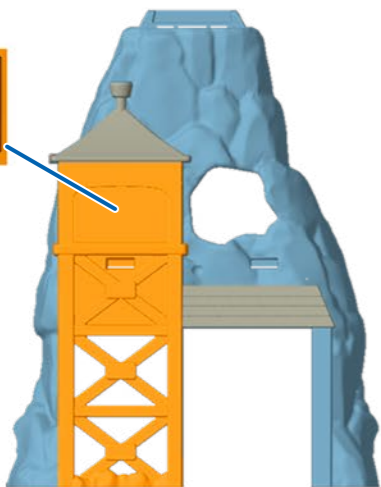
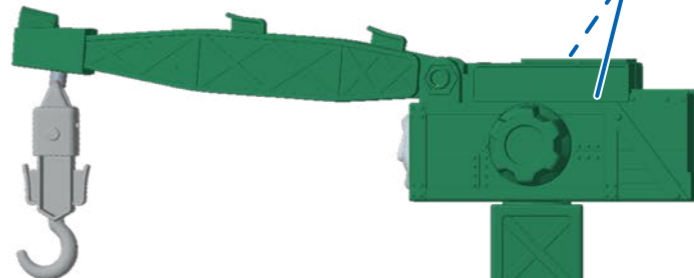

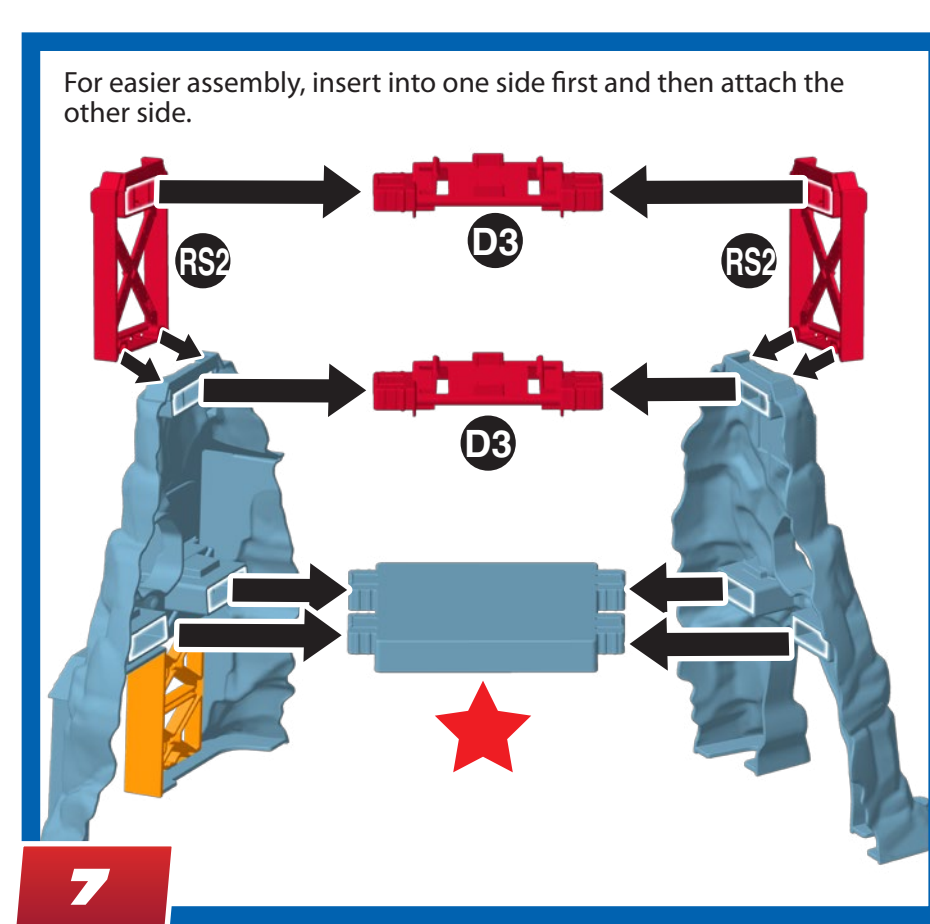
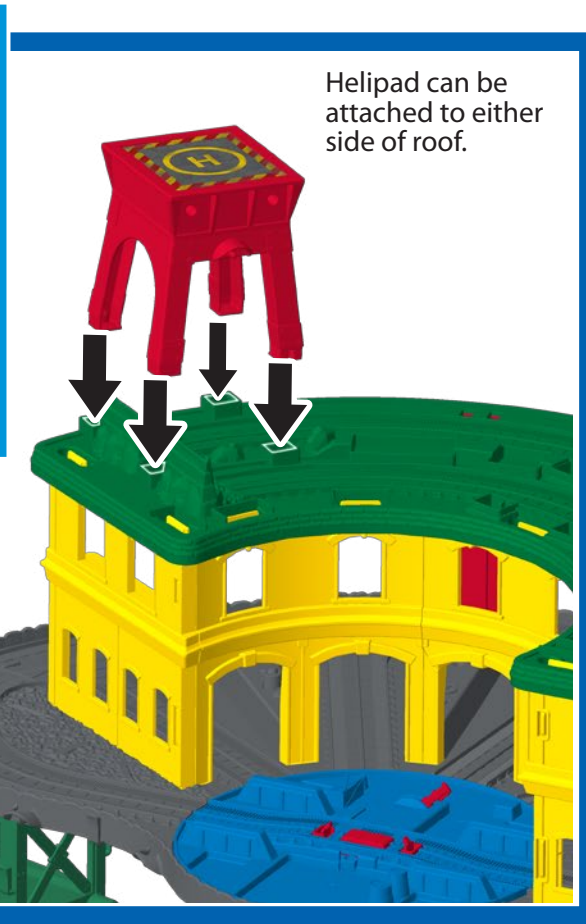
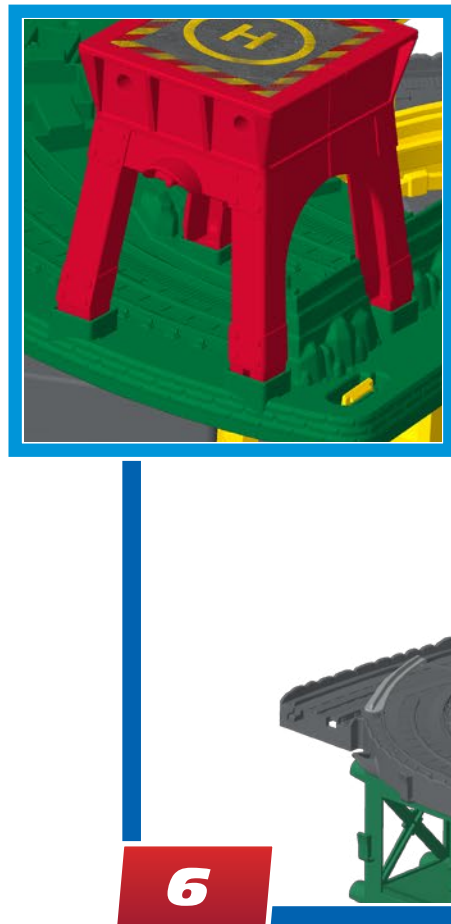
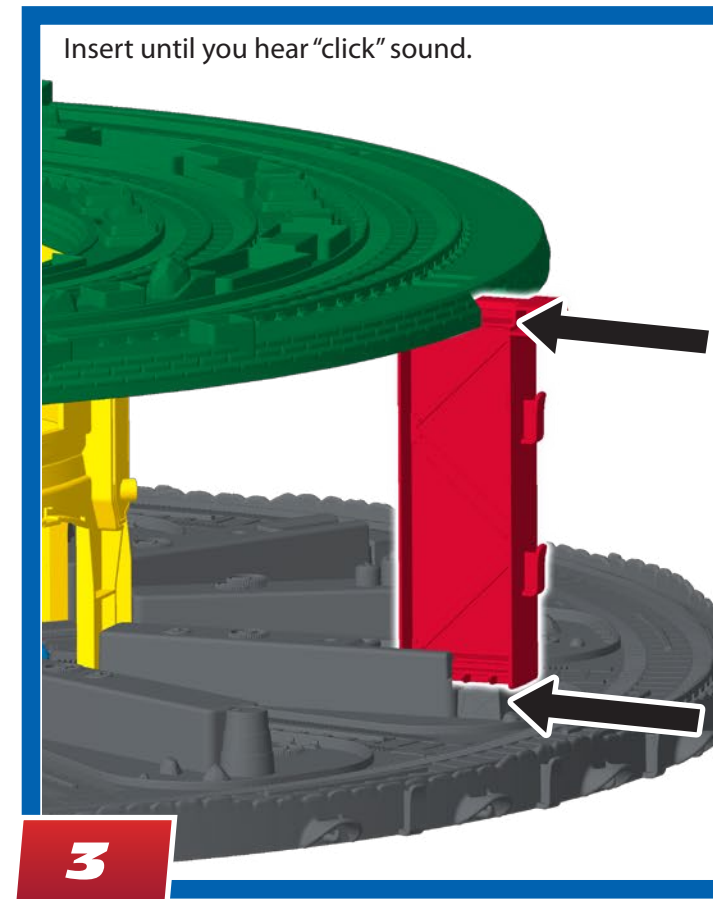
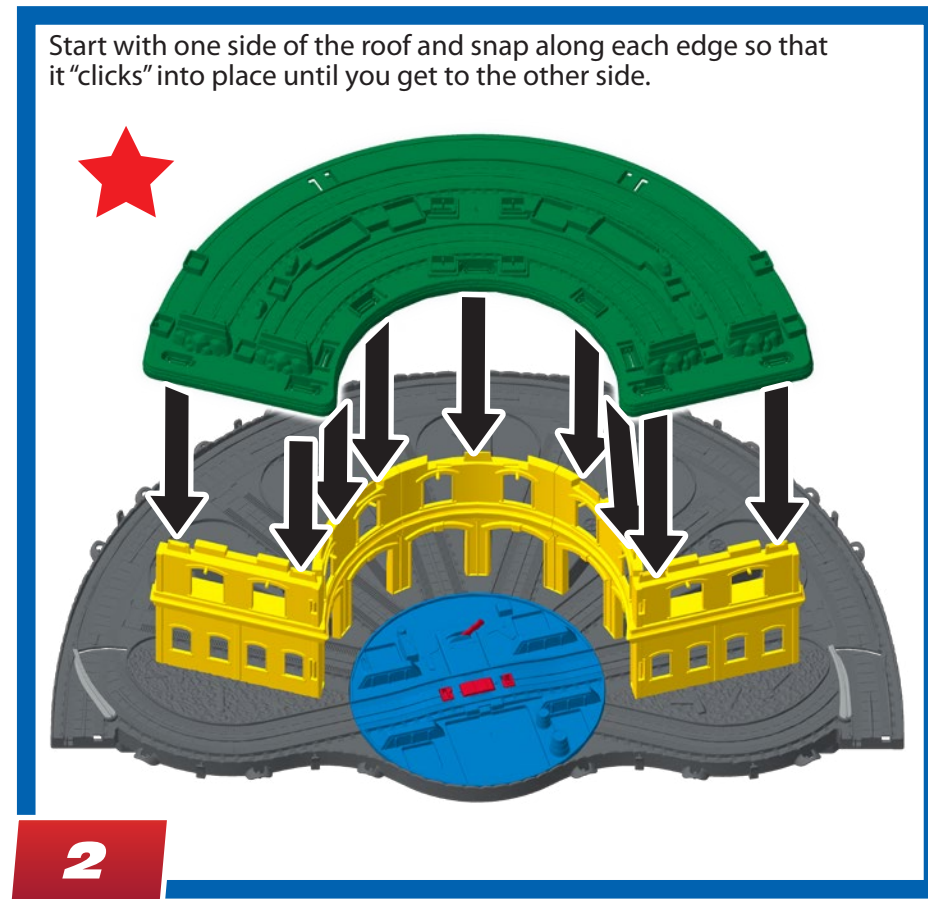
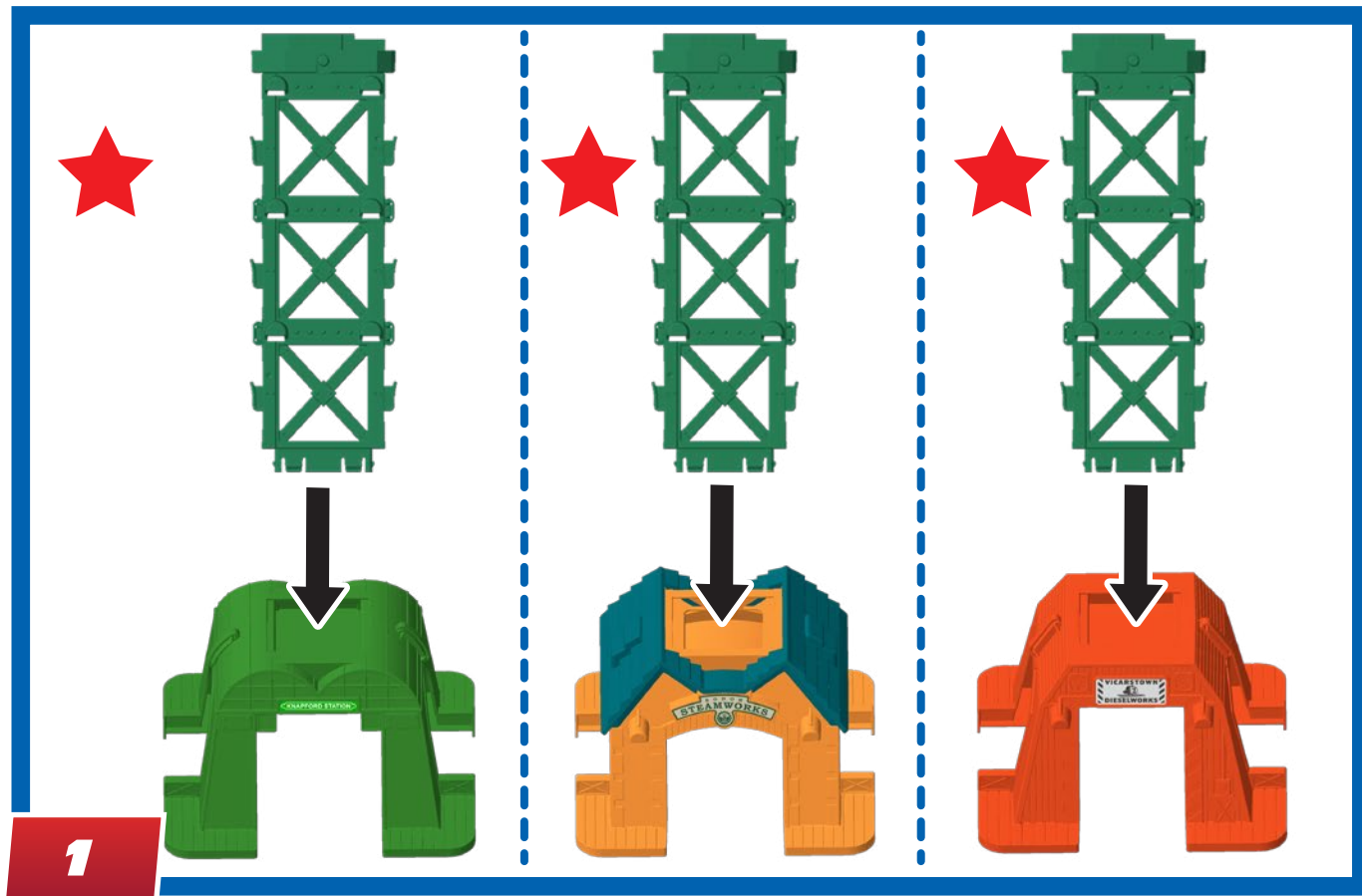

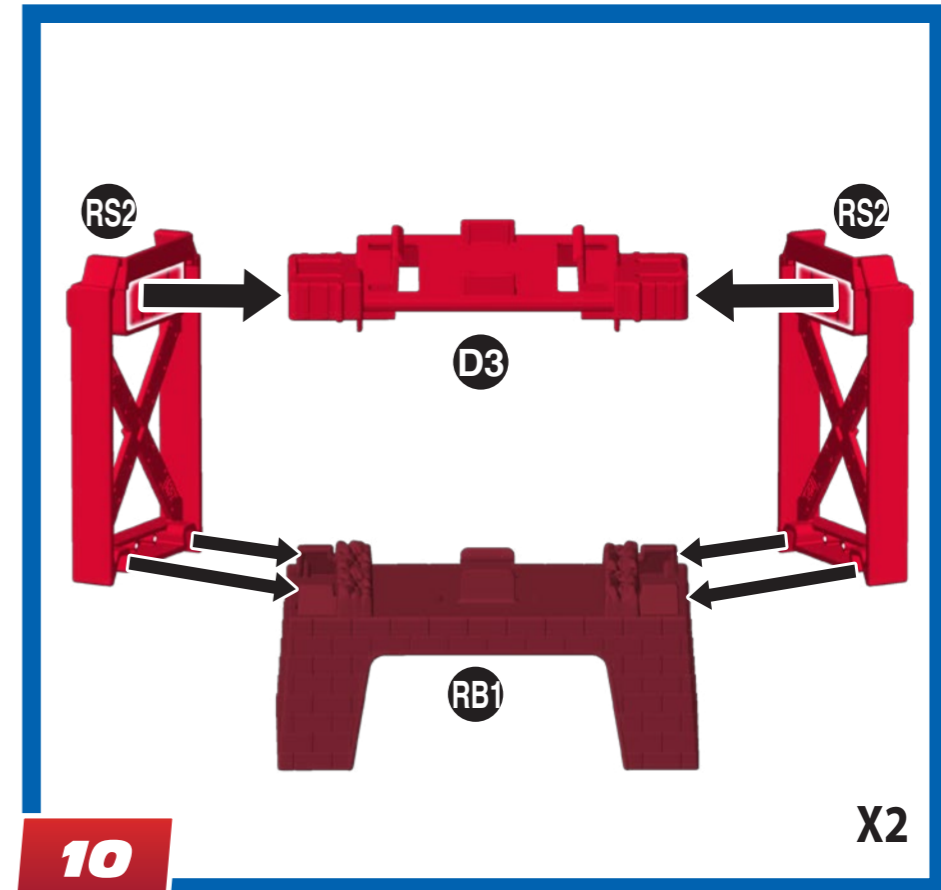
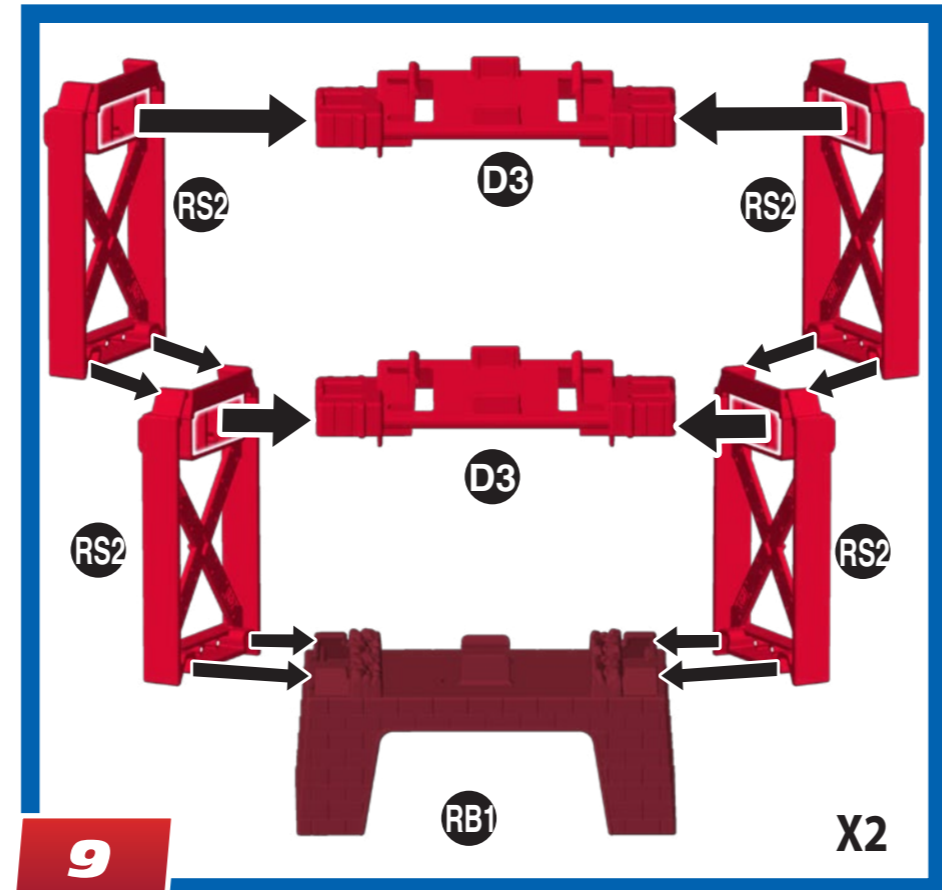
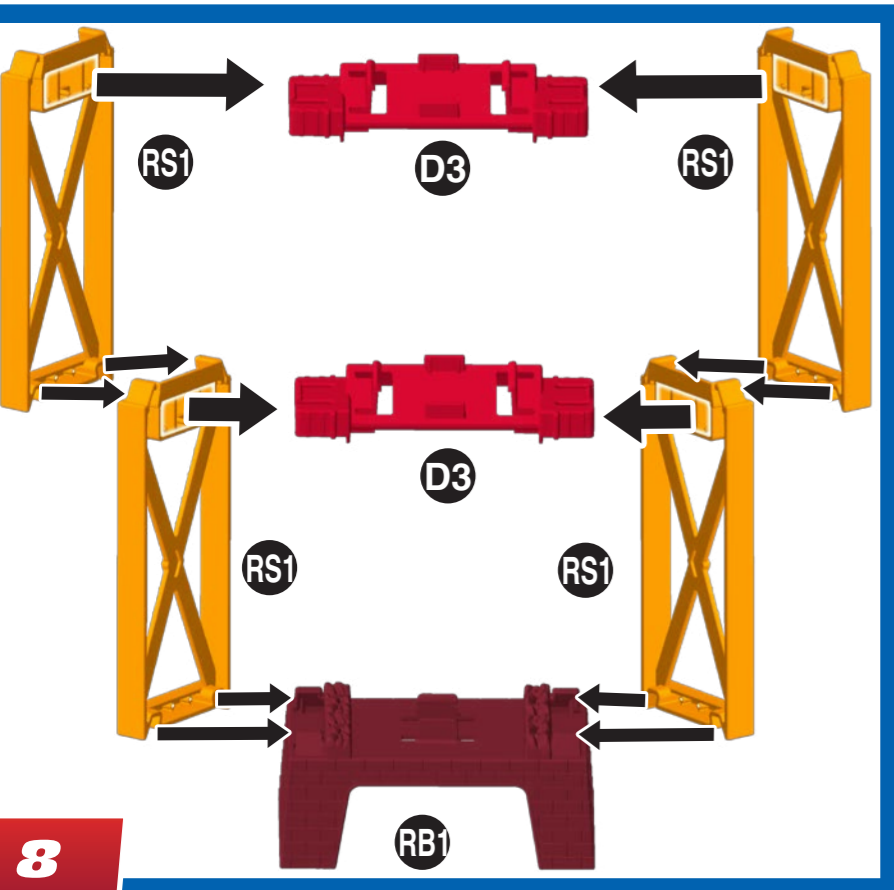
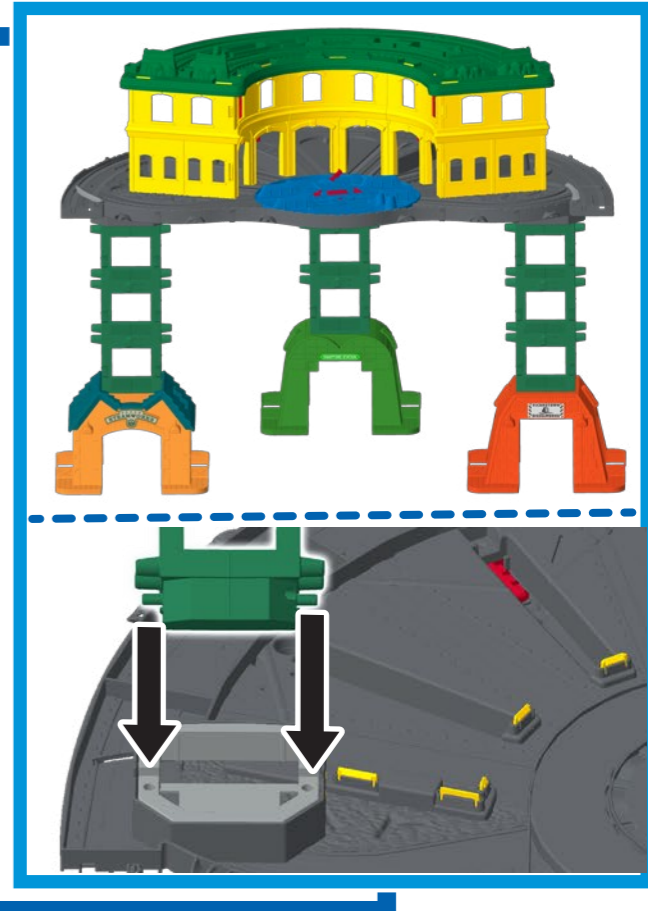
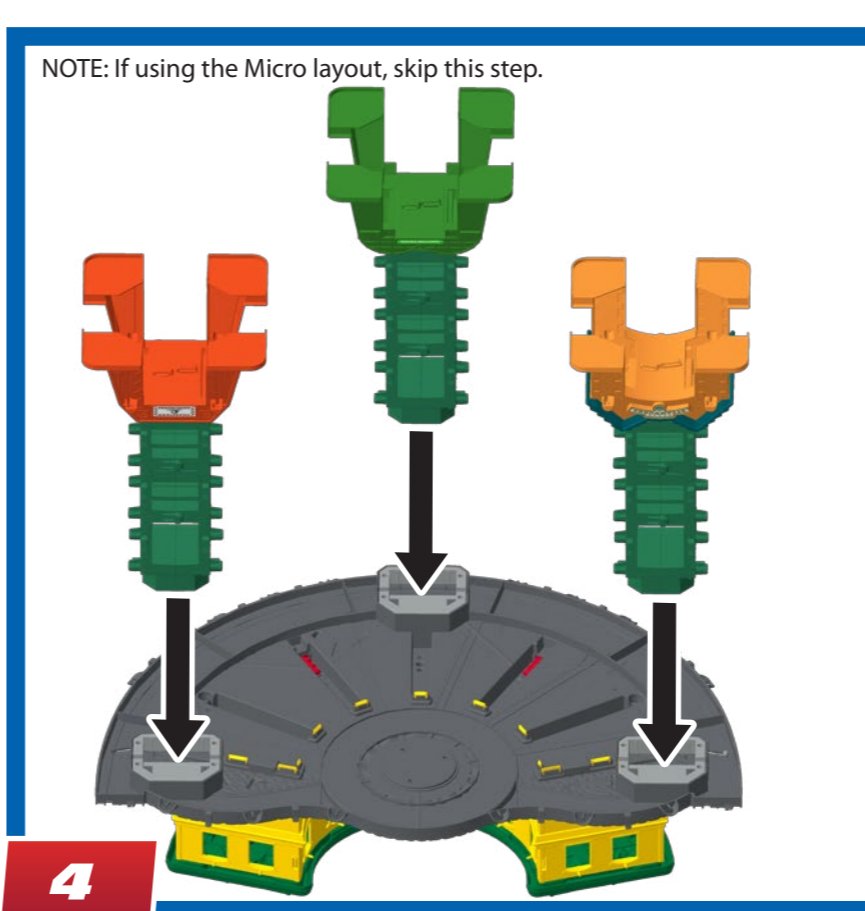
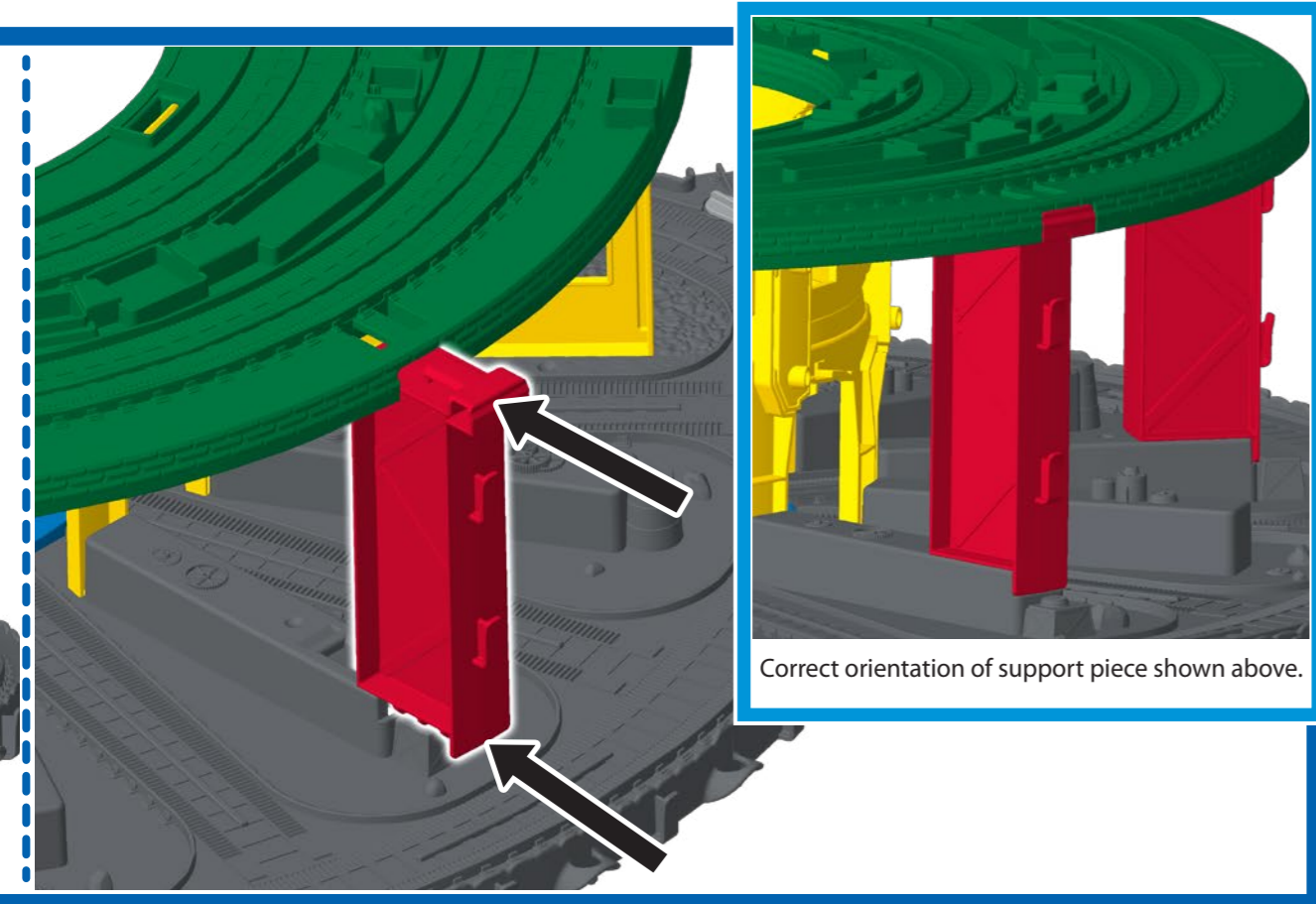

# Dual Racetrack

**Pieces Used:**

- S2 X3 YS X2 S8 X1
- S4 X1 S1 X12 CS X12
- DC X2 ES5 X2 RB1 X5
- D3 X10 ES7 X2 RS1 X4
- RS2 X14 RT X2

**Pieces Left Over:**

- S1 X1 CS X2
- S8 X3 Buffer X2

For sturdy assembly, please attach tracks at the centers of risers as shown.

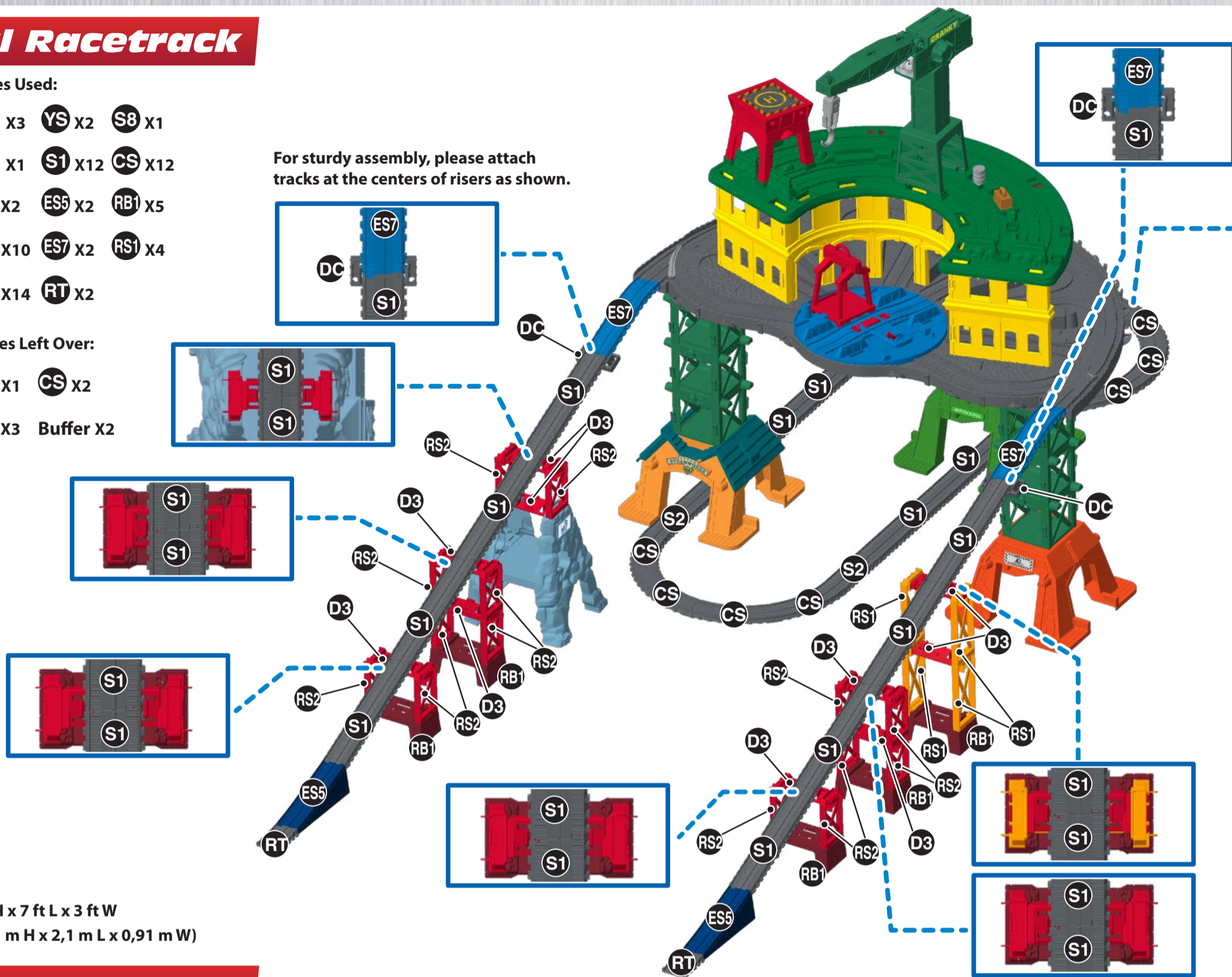

3 ft H x 7 ft L x 3 ft W  
(0,91 m H x 2,1 m L x 0,91 m W)

# Micro

**Pieces Used:**

- CS X8 DC X2
- S1 X4

**Pieces Left Over:**

- S1 X9 CS X6 RB1 X5
- S8 X4 D3 X10 RS1 X4
- RT X2 S2 X3 ES5 X2
- YS X2 S4 X1 RS2 X14
- ES7 X2 Buffer X2

**NOTE:** To build the Micro layout, do not attach legs. If going from another layout to the Micro layout, please remove legs.

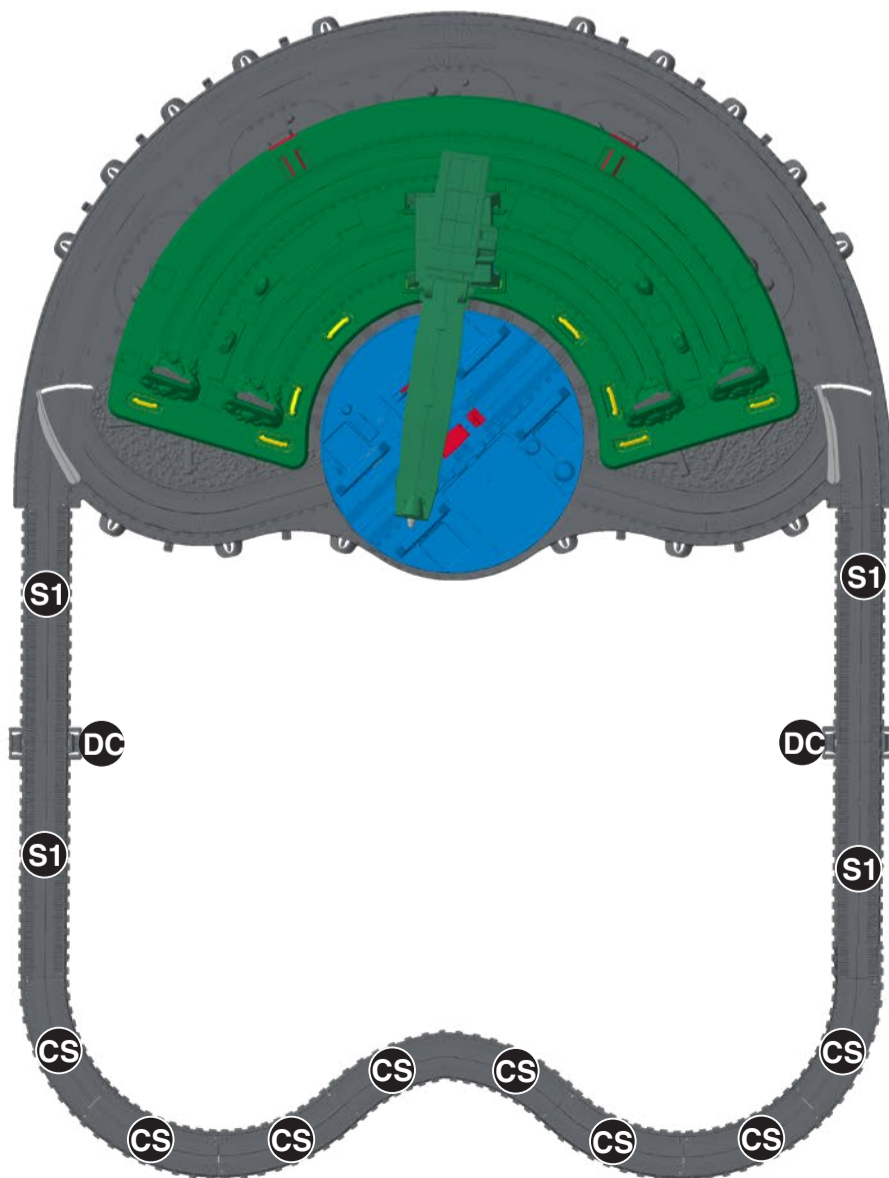

1.5 ft H x 3.5 ft L x 3 ft W  
(0,46 m H x 1,1 m L x 0,91 m W)

# TRACK LAYOUTS

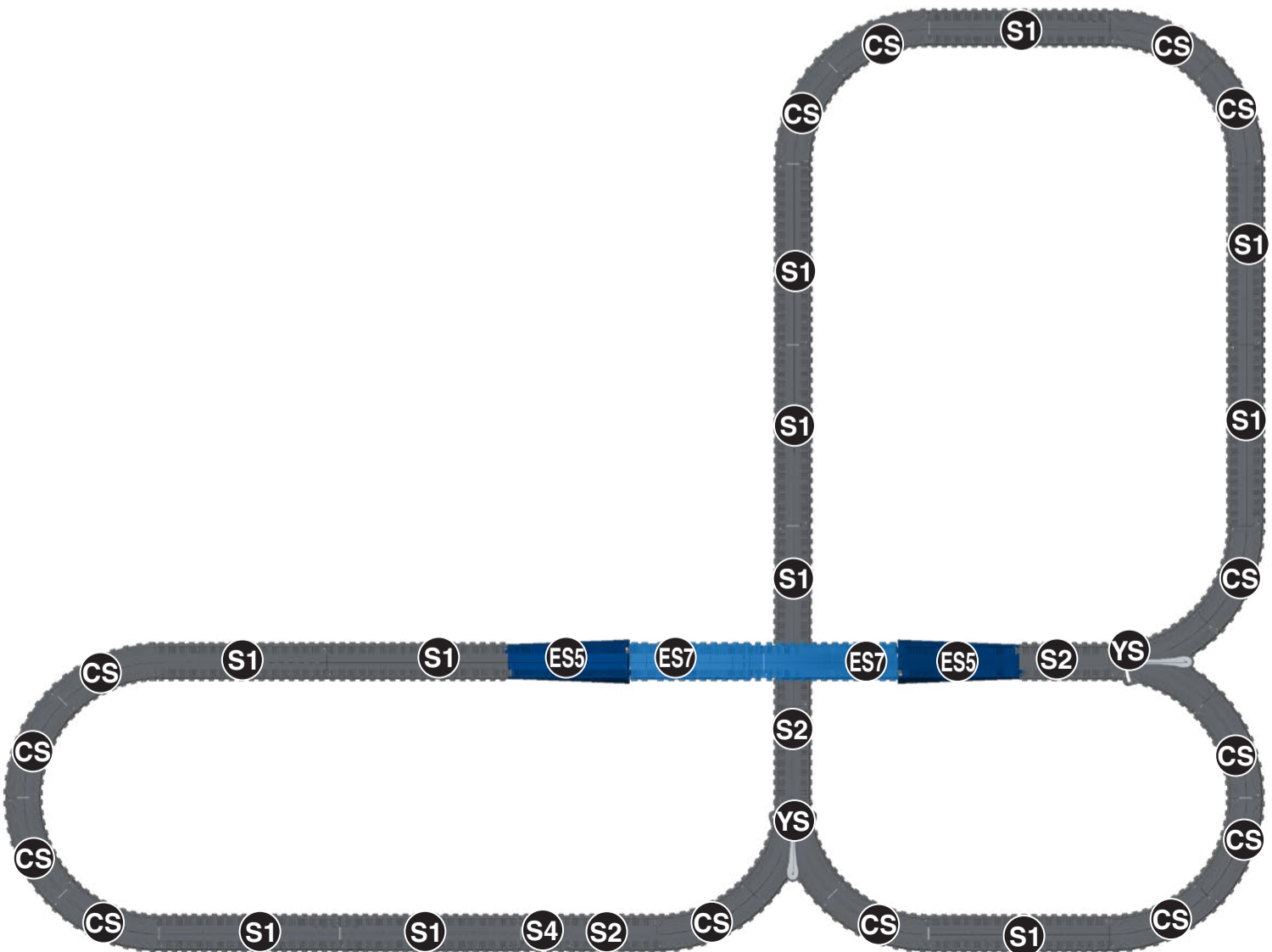
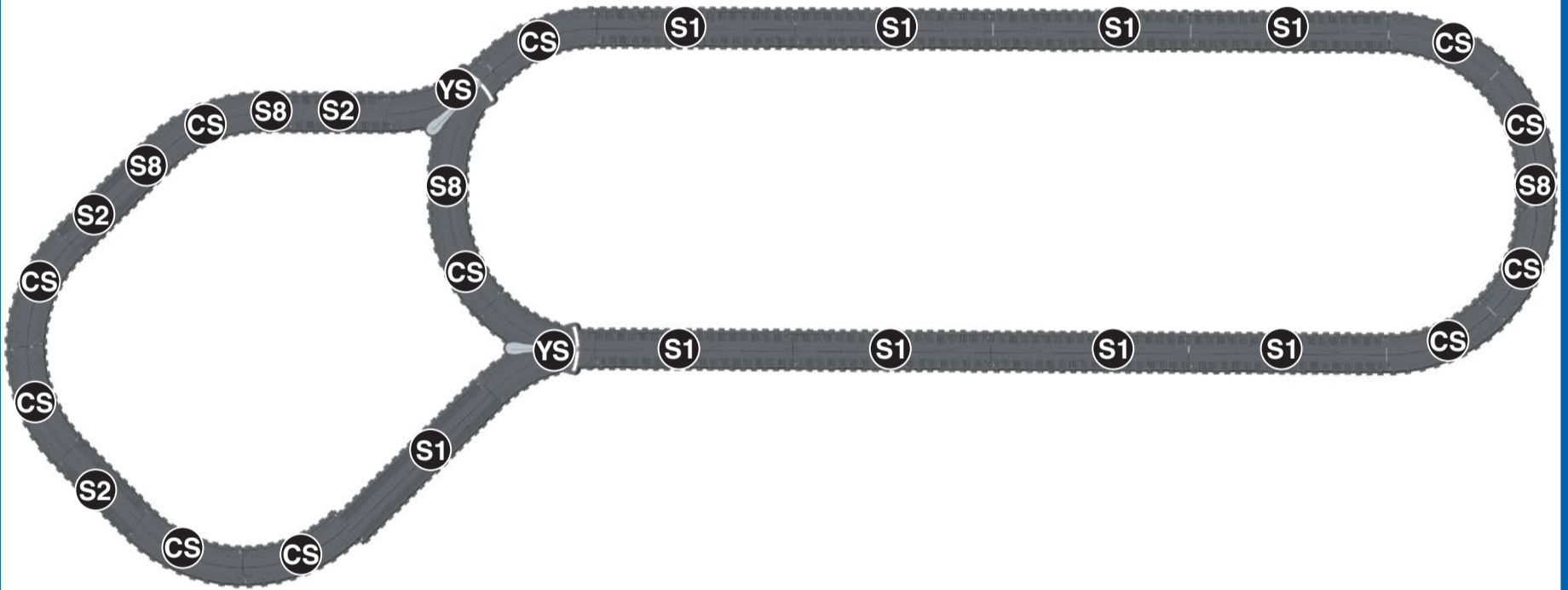
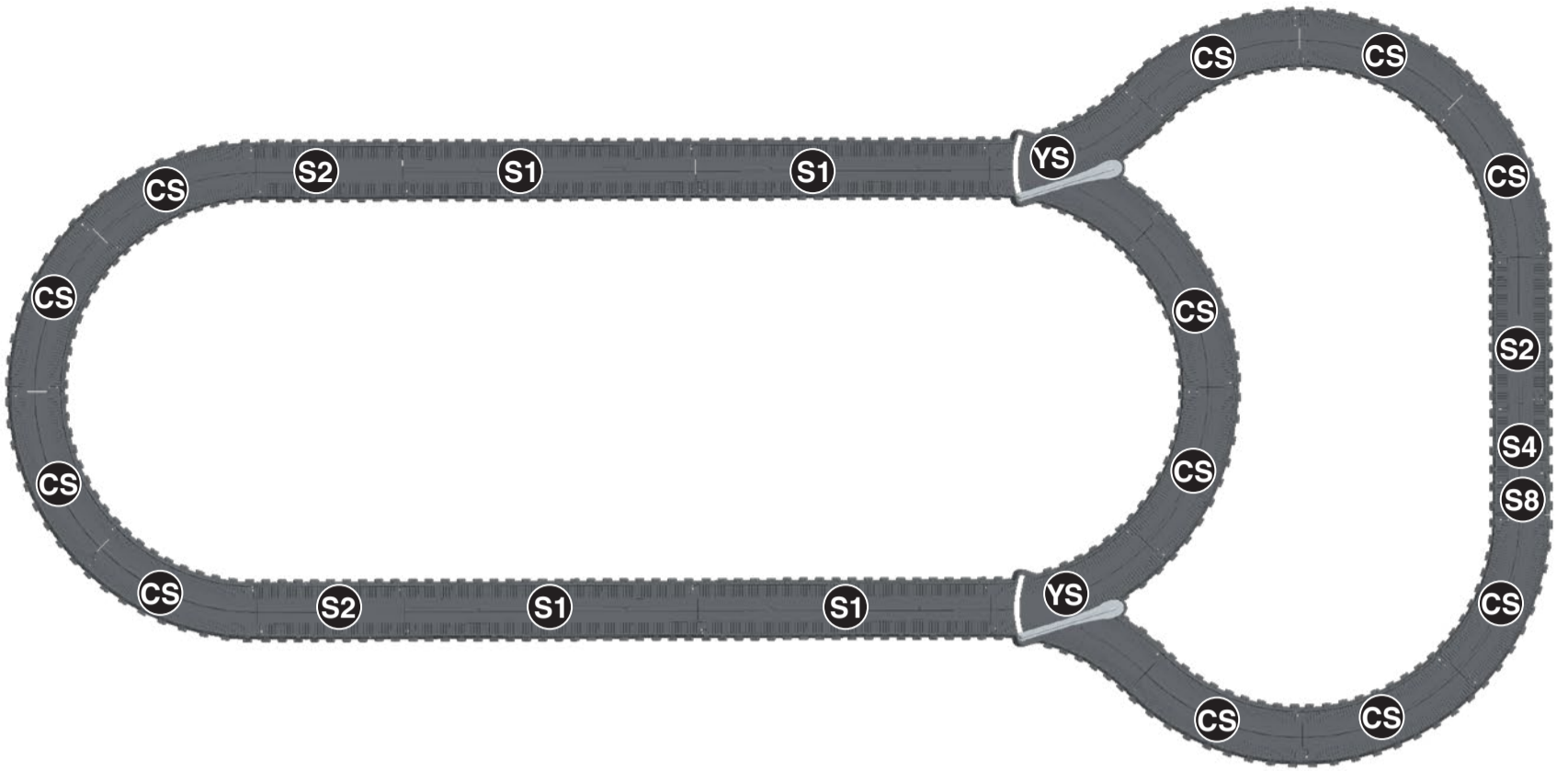



## Racetrack

### Pieces Used:

S2 X3 YS X2 S8 X4  
 S1 X13 CS X11 D3 X5  
 DC X1 ES5 X1 RB1 X2  
 ES7 X1 RS2 X8 RT X1  
 Buffer X1

### Pieces Left Over:

CS X3 D3 X5 RS1 X4 ES5 X1  
 S4 X1 RB1 X3 RS2 X6 ES7 X1  
 DC X1 RT X1 Buffer X1

3 ft H x 5.5 ft L x 5.5 ft W  
 (0,91 m H x 1,7 m L x 1,7 m W)

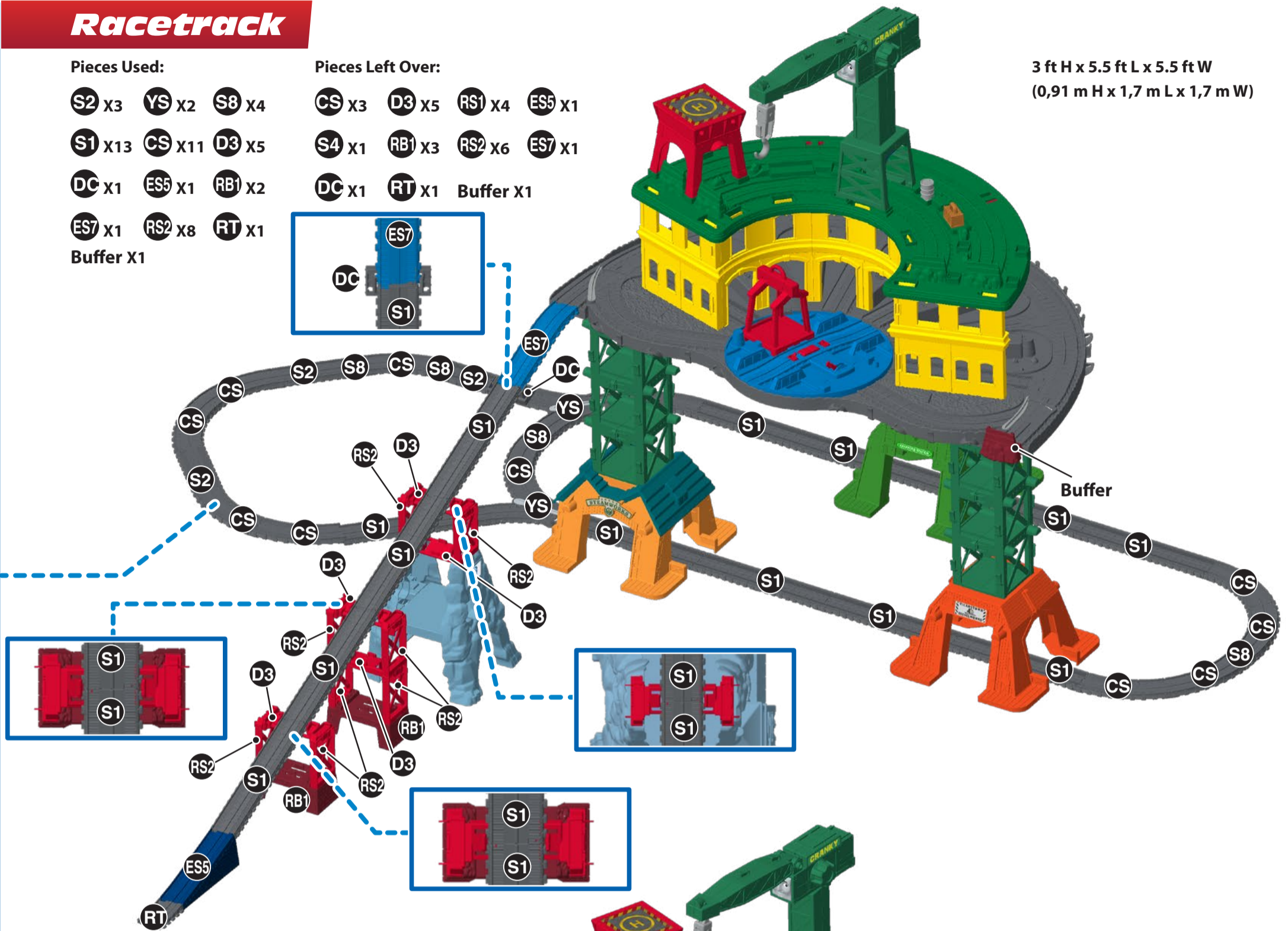

## Compact

### Pieces Used:

S2 X3 YS X2 CS X14  
 S4 X1 S1 X11 ES7 X2 ES5 X2 Buffer X2

### Pieces Left Over:

S1 X2 DC X2 RB1 X5  
 S8 X4 D3 X10 RS1 X4  
 RS2 X14 RT X2

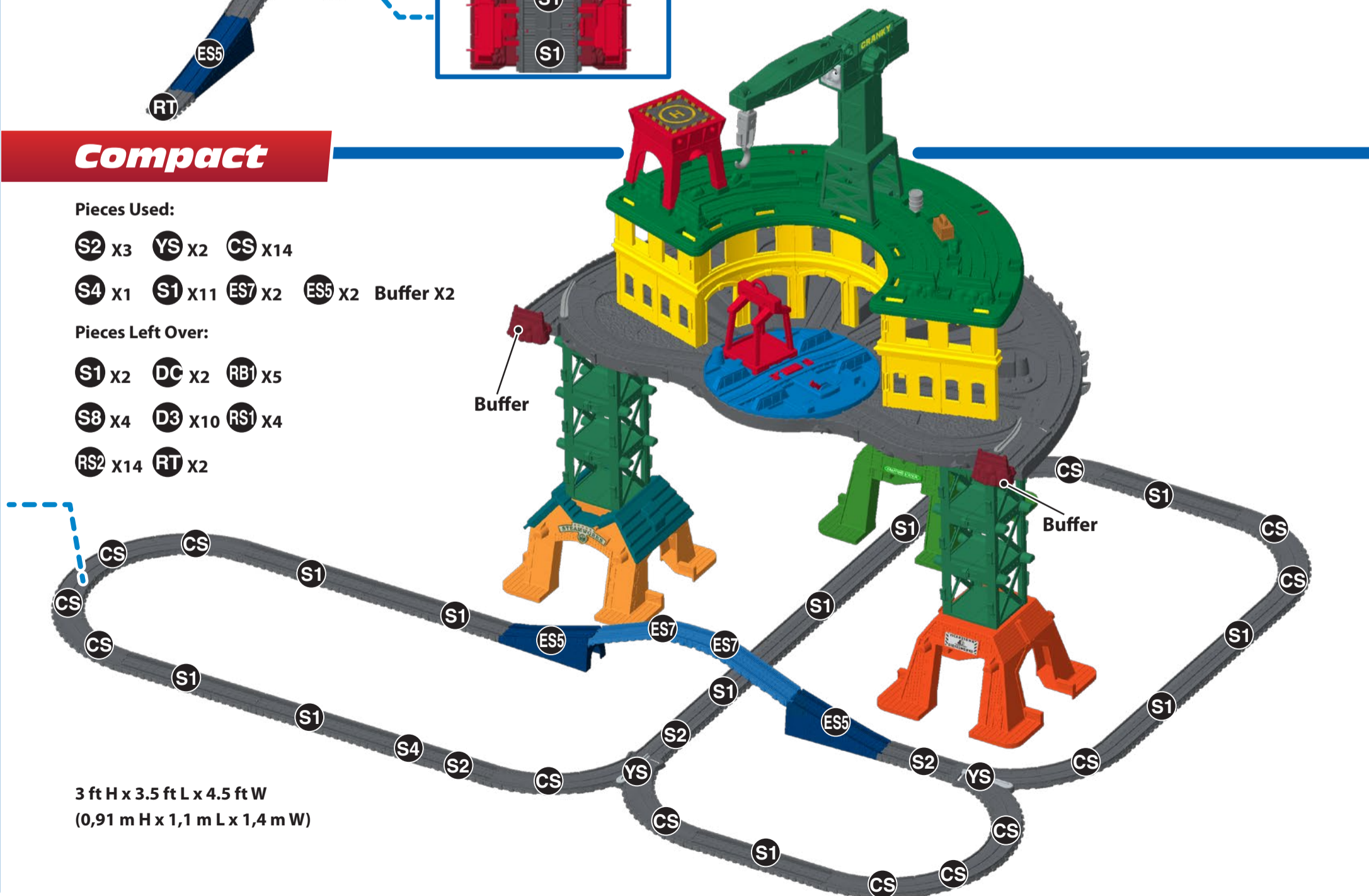

3 ft H x 3.5 ft L x 4.5 ft W  
 (0,91 m H x 1,1 m L x 1,4 m W)

Use the switch-track to control your engine's direction.

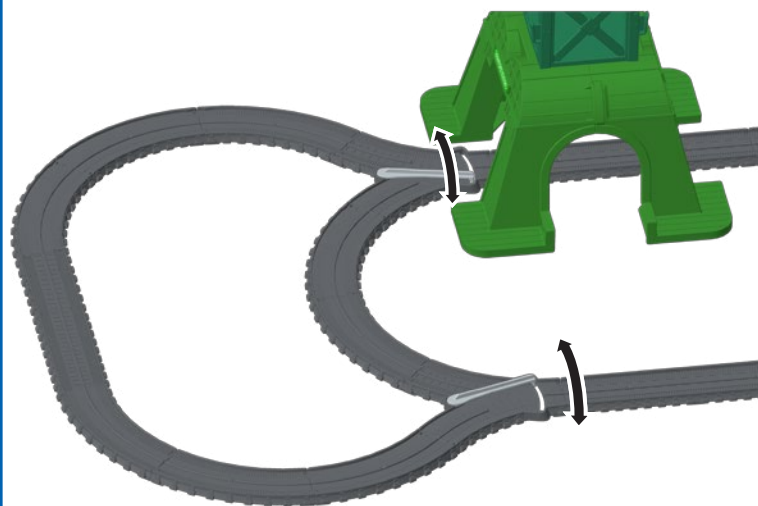

1



2

# HOW TO PLAY

Stop-track can be used to stop and start TrackMaster™ motorized engines.

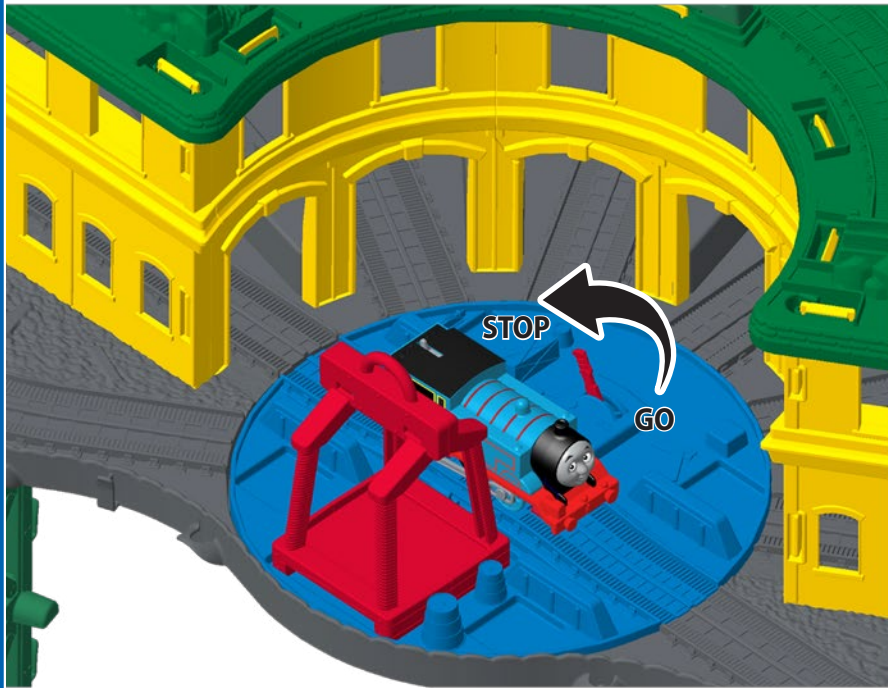

3

Move Cranky side-to-side and turn the dial to raise and lower the hook.



4

Hook only lowers when carrying weight. If the hook doesn't lower, give it a tug.

Hook can be used to lift cargo.



Engines and cargo can be carried in engine lift.

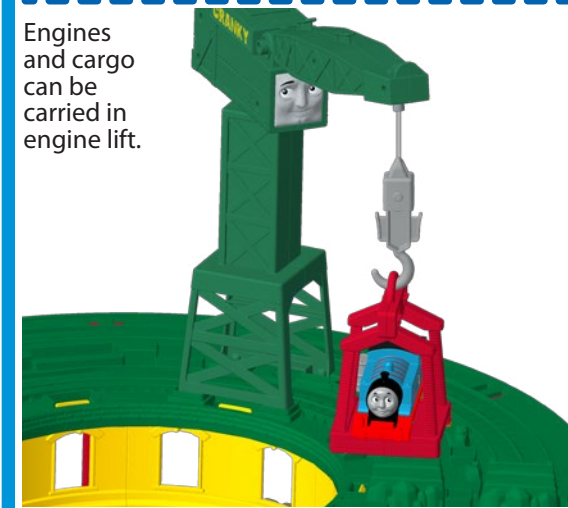

Move your engines out of Tidmouth Sheds and onto the turntable. Spin turntable to choose track.

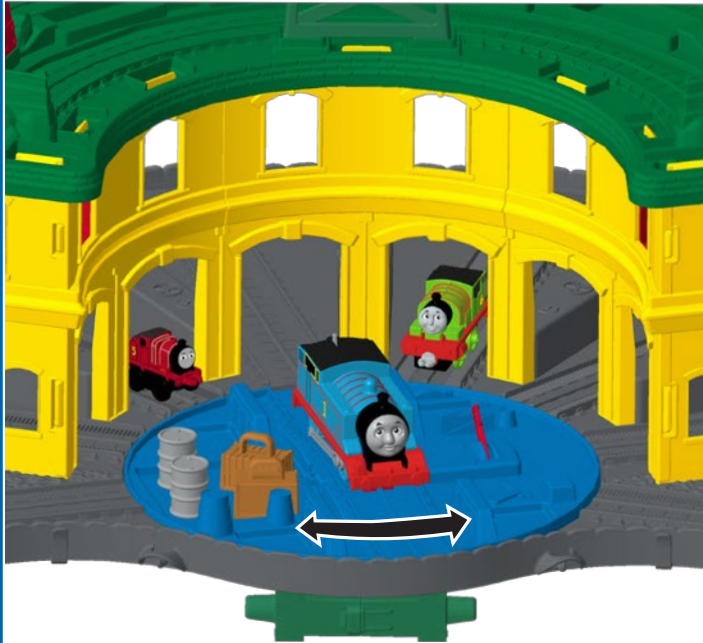

5

Engines can be stored on hooks as shown.

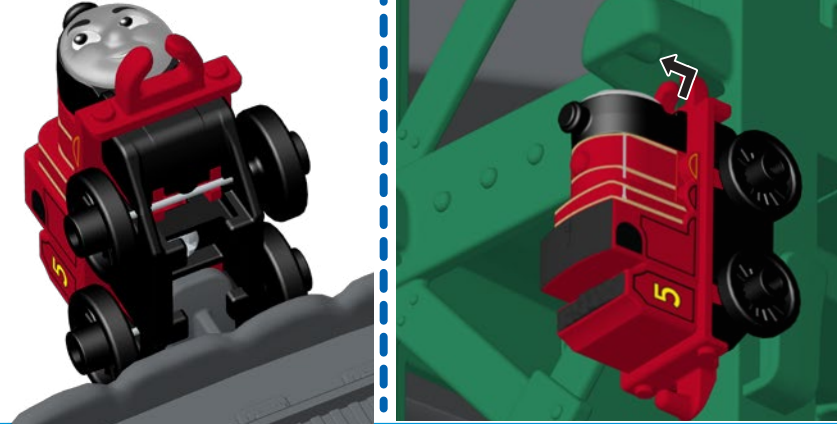

To store Adventures engines, please place onto hook on an angle until you hear a click sound.



6