

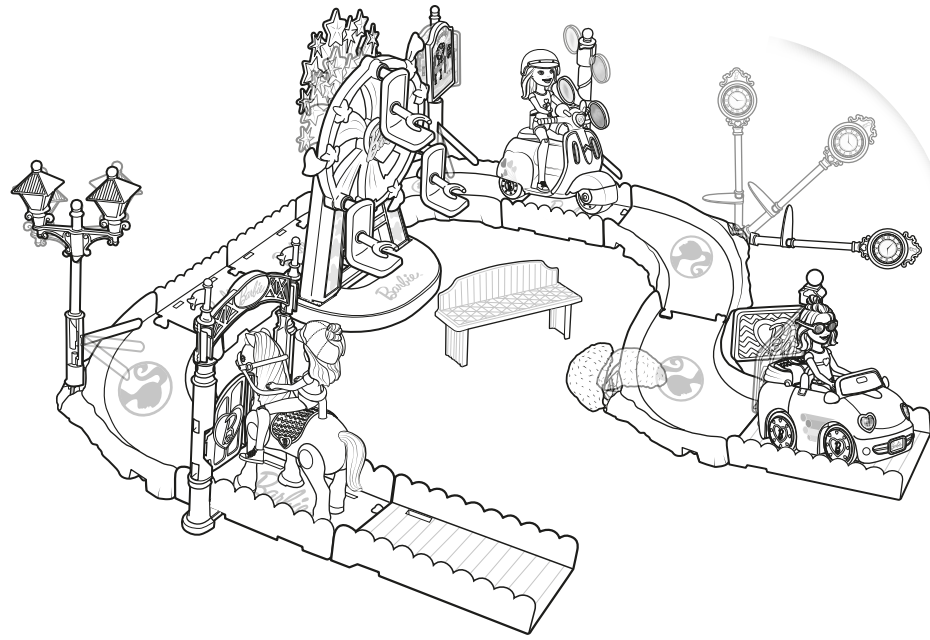

# INSTRUCTIONS

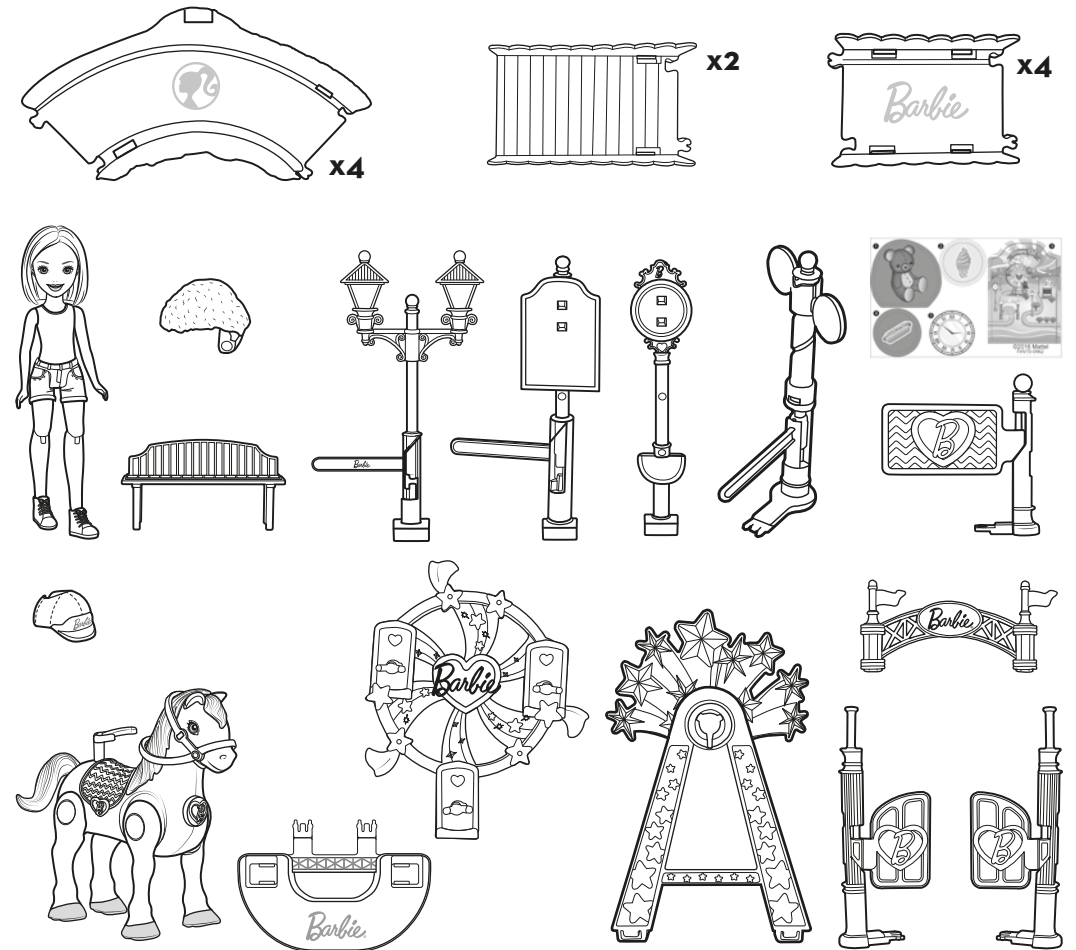

## CONTENTS



## WORKS WITH ALL SETS

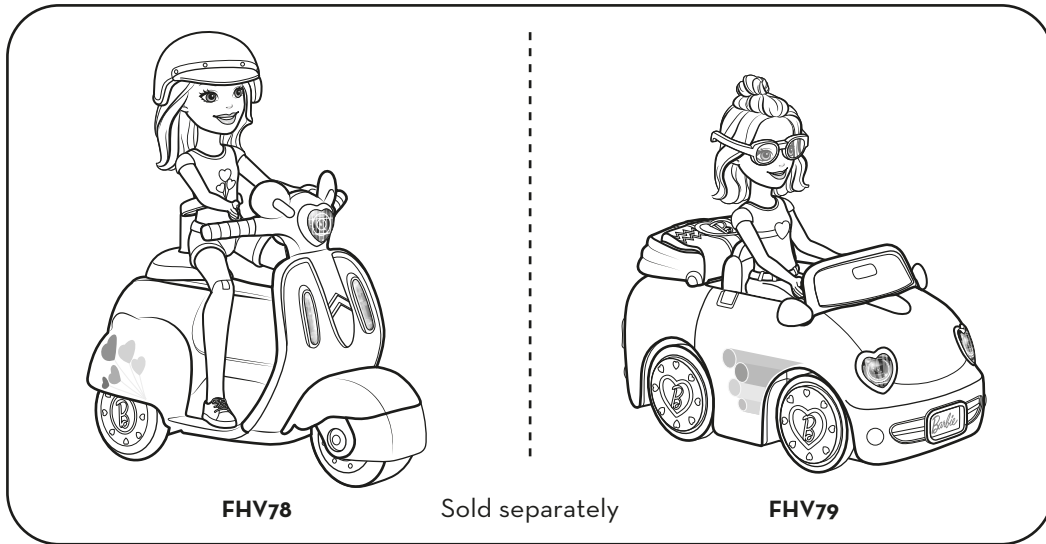

FHV78

Sold separately

FHV79

### CONSUMER INFORMATION

Need Assistance? Visit [service.mattel.com](http://service.mattel.com) or call 1-800-524-8697 (US and Canada only).

[SERVICE.MATTEL.COM](http://SERVICE.MATTEL.COM)

Mattel, Inc., 636 Girard Avenue, East Aurora, NY 14052, U.S.A. Consumer Services 1-800-524-8697. Mattel U.K. Ltd., Vanwall Business Park, Maidenhead SL6 4UB. Helpline 01628 500303. Mattel Australia Pty., Ltd., Richmond, Victoria. 3121. Consumer Advisory Service - 1300 135 312. Mattel South Africa (PTY) LTD, Office 102 I3, 30 Melrose Boulevard, Johannesburg 2196. Mattel East Asia Ltd., Room 503-09, North Tower, World Finance

Centre, Harbour City, Tsimshatsui, HK, China. Tel.: (852) 3185-6500. Diimport & Diedarkan Oleh: Mattel Southeast Asia Pte. Ltd., No 19-1, Tower 3 Avenue 7, Bangsar South City, No 8, Jalan Kerinchi, 59200 Kuala Lumpur, Malaysia. Tel: 03-78803817, Fax: 03-78803867.

Doll cannot stand alone.

**WARNING:**  
CHOKING HAZARD - Small parts.  
Not for children under 3 years.

Requires 1 AAA (LR03) alkaline battery (not included).  
This product is not recommended for use on loose dirt or wet surfaces. Do not immerse in water.  
Please remove everything from the package and compare to the contents shown here. If any items are missing, please contact your local Mattel office. Keep these instructions for future reference as they contain important information.

# ASSEMBLY

## Battery Installation

Use a Phillips head screwdriver (not included) to open battery door. Insert 1 AAA (LR03) battery (not included). Do not connect to more than the recommended number of power supplies. Replace battery door and tighten screw. Dispose of battery safely. Replace battery when horse doesn't move. For longer life, use only alkaline battery. When exposed to an electrostatic source, the product may malfunction. To resume normal operation, remove and re-install the battery.

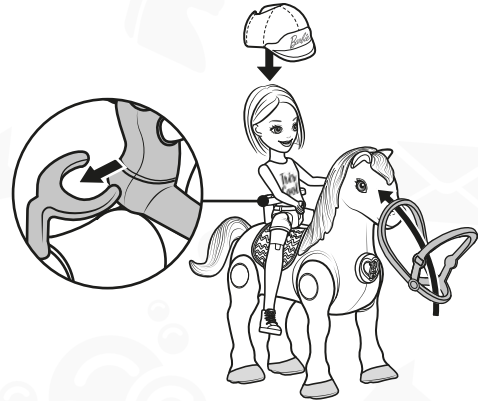
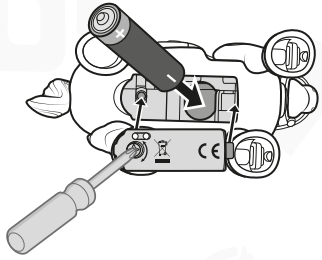

5

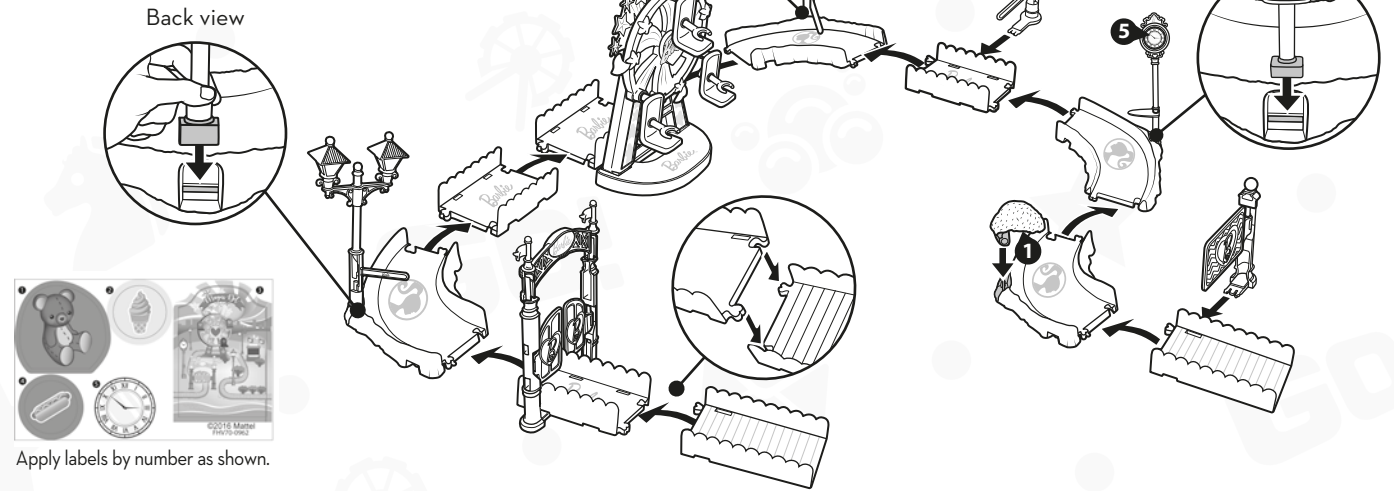

Apply labels by number as shown.

## HOW TO PLAY

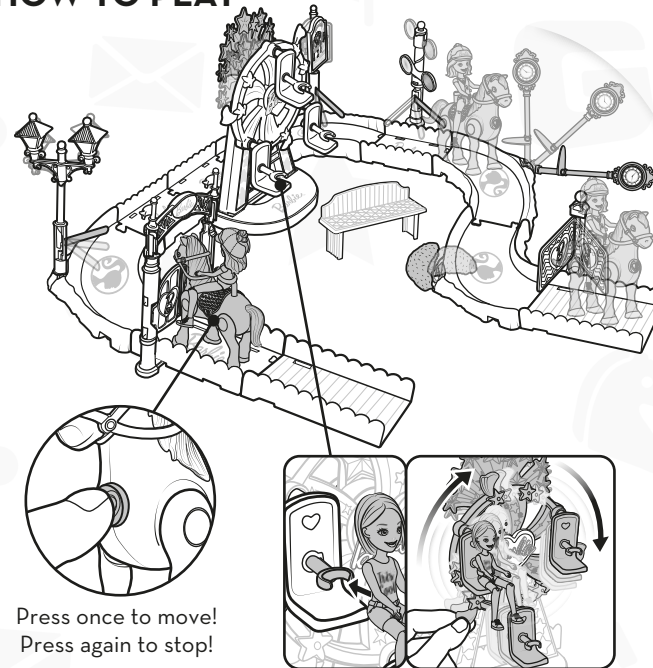

Press once to move!  
Press again to stop!

## RESET

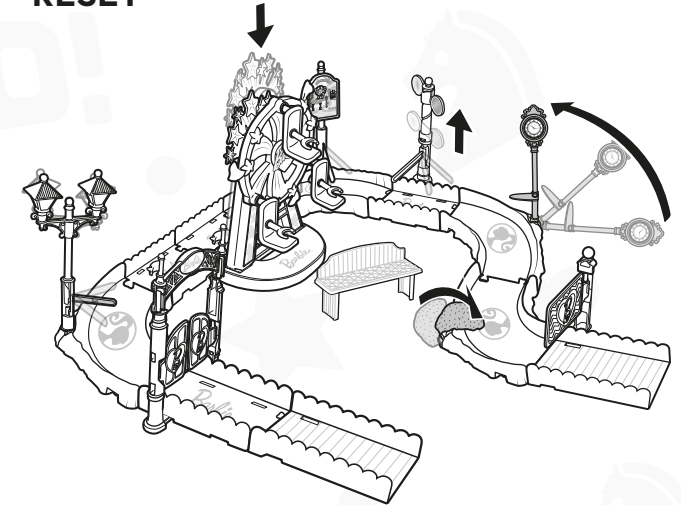

1

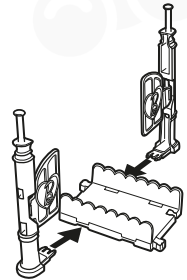

2

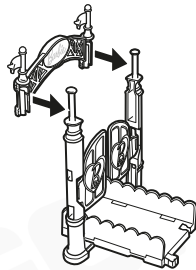

3

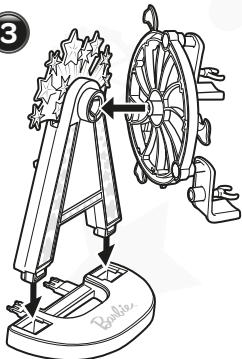

4

