

MEGA
CONSTRUX™

HALO



FMM89

2x
AM18560F



4x
AM76558ALG



2x
MA17003EA



2x
MA19392EA



1x
MA19392APG



2x
MA07223MM



1x
MA07223F



1x
MA07223ANW



1x
AM74299MM



1x
AM74300MM



1x
AM15486F



1x
AM78273ANW



1x
MA17787APD



4x
MA19999ANW



1x
AM72001ANW



2x
AM15485MM



1x
AM74415MM



1x
AM17507MM



1x
AM18740F



1x
MA09198F



1x
MA09393F



2x
AM72534F



2x
MA73906MM



2x
MA74426ANW



2x
MA74427ANW



3x
MA72002MM



1x
MA72000MM



1x
MA15480MM



1x
MA15481MM



1x
MA1417ANW



1x
MA18543ANW



1x
AS-FMM89-01



2x
AM73904APG



1x
AM18265F



2x
AM76354ALG



2x
MA1314ANW



1x
MA72600MM



1x
AM72439ANW



2x
AM79106APG



1x
AM79105MM



1x
AS-FMM89-02



1x
AS-FMM89-03



1x
MA09593ANW



1x
AM72601MM



2x
AS-FMM89-04



2x
AS-FMM89-05





1x
AM17159APG



1x
AM76357ANW



1x
AM18257F



1x
FIG-FMM89-A



Please read these instructions carefully before first use and keep them for future reference.
Il est recommandé de lire attentivement ce feuillet avant la première utilisation et de le conserver pour référence future.
Leer estas instrucciones cuidadosamente antes de la primera utilización y guardarlas para referencia futura.
Leia as instruções antes do primeiro uso e guarde-as para futura referência.

Leggere le istruzioni prima di cominciare ad usare il gioco e conservarle per referenze future.
Die Gebrauchsanleitung bitte durchlesen und aufbewahren.
Proszę uważnie przeczytać instrukcję obsługi przed pierwszym użyciem, a następnie zachować ją na przyszłość.
Wij raden u aan deze handleiding zorgvuldig te lezen en te bewaren voor eventuele raadpleging op een later tijdstip.
Внимательно прочитайте инструкцию перед первым использованием и сохраните ее для дальнейшего использования.
Vær venlig at læse disse instruktioner omhyggeligt inden ibrugtagen og opbevar dem til fremtidigt brug.
Läs noggrant igenom dessa instruktioner innan du använder produkten för första gången och spara dem för ev. framtida frågor.
Les disse instruksjonene nøye før første gangs bruk, og ta vare på dem for fremtidige oppslag.
Lue nämä ohjeet huolellisesti ennen ensimmäistä käyttöä ja säilytä ne myöhempää tarvetta varten.

Διαβάστε προσεκτικά τις οδηγίες πριν από τη χρήση και κρατήστε τις για μελλοντική αναφορά.
İlk kullanımdan önce talimatları dikkatlice okumanızı ve bu bilgileri ileride tekrar bakabilmek için saklamanızı öneririz.
第一次使用前，请仔细阅读本说明书并保留以备将来参考。
初めてご使用になる前に、この説明書をよくお読みください。また、本書は将来いつでも参照できるように保管してください。

يجب قراءة هذه التعليمات بعناية قبل الاستخدام والاحتفاظ بها للعودة إليها مستقبلاً.



© 2017 MICROSOFT CORPORATION. ALL RIGHTS RESERVED.
MICROSOFT, 343 INDUSTRIES, THE 343 INDUSTRIES
LOGO, HALO, THE HALO LOGO ARE TRADEMARKS OF THE
MICROSOFT GROUP OF COMPANIES.



1

1X

1X

1X



1X



1X

2

1X



1X



1X



1X



1



2



1



2



1



2

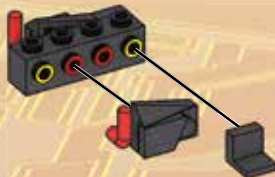

1



2

3



4

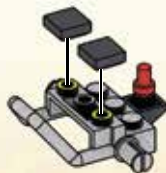

5**1X****1X****6****2X****1X****1X****1X****1****2****3**

7

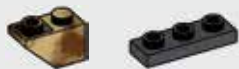

1X

1X

8



1X

1X

1X

1X



1

2

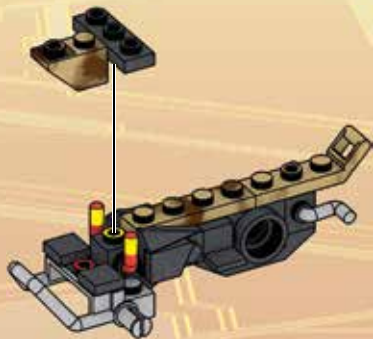

9



1X

1X

1X

1X

10



1X

1X

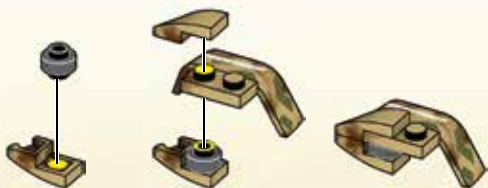

1

2

3

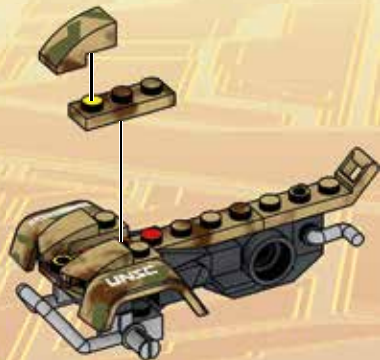

11



1X

2X

1X



12



1X

1X

1X

1X

1X

1X



1

2



13



1X



2X



1X



1X

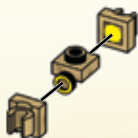

1



2



3



4



1



2

14



2X



2X



1X



1X



1



2

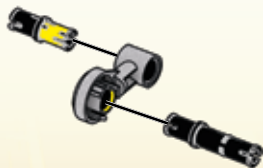

1



2



15



1X



1X



1X



16



2X



2X



2X



1X

x2



17



2X



2X

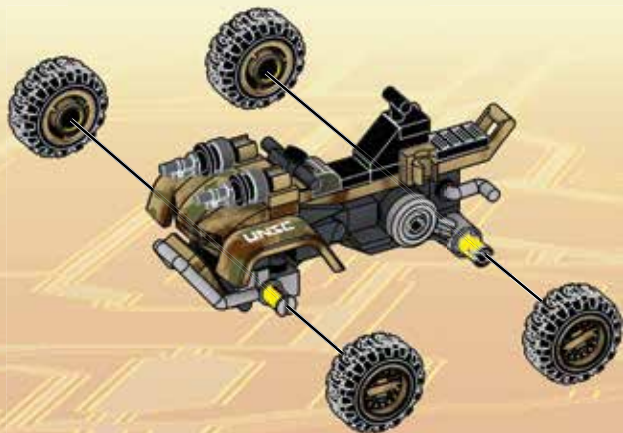

18





Spartan Pathfinder



SUPRESSED SMG



FMM91

MORE TO COLLECT! / BIEN PLUS À COLLECTIONNER!
/ IMÁS JUGUETES PARA COLECCIONAR! /
MAIS PARA COLECCIONAR! / TANTI ALTRI DA
COLLEZIONARE! / ZUM SAMMELN! / WIĘCEJ DO
ZEBRANIA! / NOG MEER OM TE VERZAMELEN!
/ СОБЕРИ БОЛЬШЕ! / ΣΥΛΛΟΓΉ! / HEPSINI
BIRIKTIR, KOLEKSIYONUNA EKLE! / ادي زملما لئانه



Each sold separately and subject to availability. / Produits vendus séparément, selon la disponibilité. / Se venden por separado y están sujetos a disponibilidad.
 / Vendidos em separado e sujeitos à disponibilidade. / Ognuno in vendita separatamente secondo disponibilità. / Alle Artikel separat erhältlich. Einige Artikel werden nicht in allen Ländern vertrieben. / Sprzedawane oddzielnie w zależności od dostępności. / Per stuk verkrijgbaar en niet overal leverbaar. / Каждый продукт продается отдельно, в зависимости от наличия. / Sælges separat og så længe lager haves. / Alla delar säljs separat så långt lagret räcker. / Hver leke selges separat så langt lageret rekker. / Jokainen myydään erikseen, saatavuus voi vaihdella. / Το καθένα πωλείται ξεχωριστά και ανάλογα με τη διαθεσιμότητα. / Her biri ayrı ayrı ve stoklara bağlı olarak satılır. / 每件单独出售，并且视库存情况而定。 / それぞれ在庫状況に従って個別に販売されます。 / قدح وىل اعنم لك عابيت / امر فوئتل اعض ختو

MEGA CONSTRUX™

Build Beyond™

Au-delà de la construction!

¡Construye sin límites!

Mais do que Construção!

Costruisci oltre ogni limite!

Es gibt keine Grenzen!

Więcej niż budowanie!

Meer dan alleen bouwen!

Больше, чем конструктор!

Χτίσε έναν ολόκληρο κόσμο!

Hayallerini İnşa Et!

لتبني .. وأكثر!



▶ megaconstrux.com

