

MEGA  
CONSTRUX™

POKÉMON™

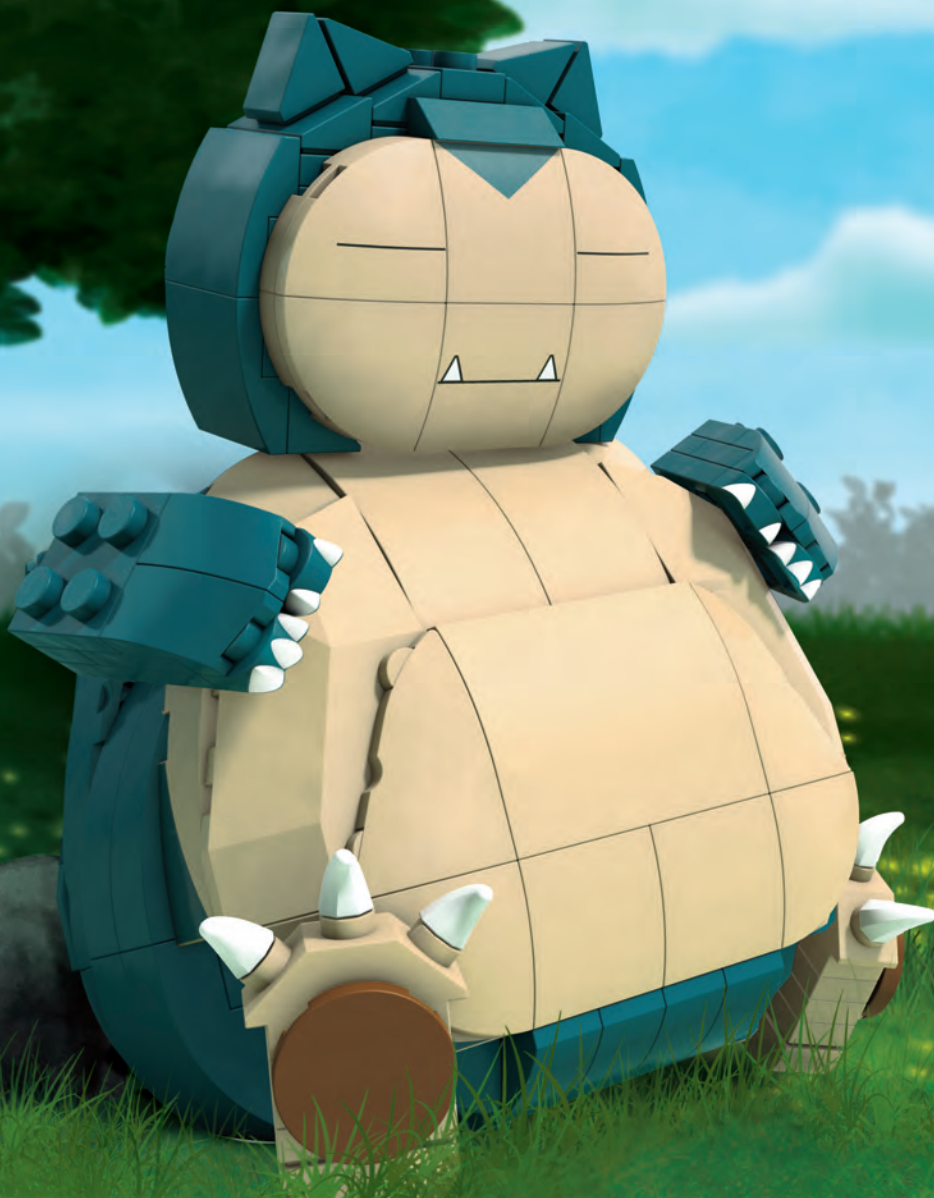

FPM11

6x  
AM79425E

1x  
AM78291VF

2x  
MA74397VF

2x  
MA03328BTN

2x  
MA03328VF

2x  
AS-FPM11-10

2x  
AS-FPM11-11

2x  
AS-FPM11-15

2x  
AM79377BTN

2x  
AM77574VF

1x  
AM74299VF

1x  
AM74300VF

2x  
AM76058AMC

2x  
AM76058BYE

2x  
AM78396VF

7x  
AM78296VF

2x  
AM73448VF

4x  
MA17787BTN

4x  
MA15258VF

2x  
MA1086VF

2x  
MA07629VF

2x  
AM77445VF

2x  
AM79246BYE

1x  
MA07590VF

1x  
MA09393BTN

18x  
MA09393VF

2x  
MA022501VF

2x  
MA16680BTN

1x  
MA16680VF

1x  
AM79369VF

1x  
AM78398VF

2x  
AM78397VF

2x  
AM18014VF

4x  
MA09835VF

2x  
AM76467BTN

2x  
AM78280VF

4x  
AM73989VF

3x  
MA74427VF

3x  
MA74426VF

2x  
MA16679VF

2x  
MA04430VF

6x  
MA09013VF

6x  
MA17502VF

2x  
AM18601VF

4x  
MA17788VF

1x  
AS-FPM11-09

1x  
AS-FPM11-12

2x  
AM74060BTN

4x  
AM04322VF

4x  
AM04322BTN

1x  
MA18665VF

1x  
MA18666VF

2x  
MA15484VF

2x  
AM02215MY

10x  
MA03773VF

1x  
AM78282BTN

1x  
MA1146VF

1x  
AS-FPM11-03

1x  
AS-FPM11-04

4x  
AM76525BTN

4x  
AM76525VF

2x  
AM74106BTN

7x  
AM74106VF

1x  
AS-FPM11-01

1x  
AS-FPM11-02

2x  
MA09023VF

2x  
AM04320BTN

2x  
AM04320VF

1x  
AS-FPM11-13

1x  
AS-FPM11-14

2x  
AM17509VF

5x  
MA03772VF

2x  
AM19012VF

1x  
AM75525BTN

1x  
AM75526BTN

1x  
AM75526VF

1x  
AM75525VF

1x  
AM74798VF

1x  
AS-FPM11-07

1x  
AS-FPM11-08

4x  
MA03873VF

2x  
MA1141VF

2x  
MA09593VF

1x  
MA1087VF

8x  
MA09493VF

1x  
AM18299VF

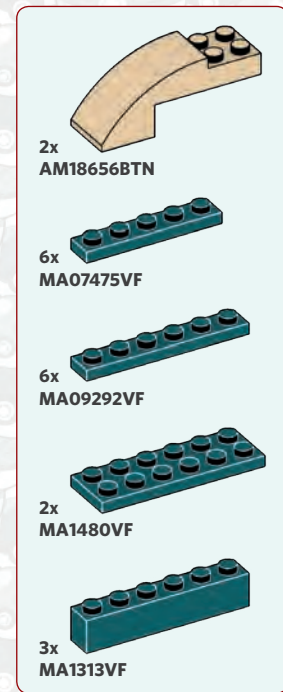
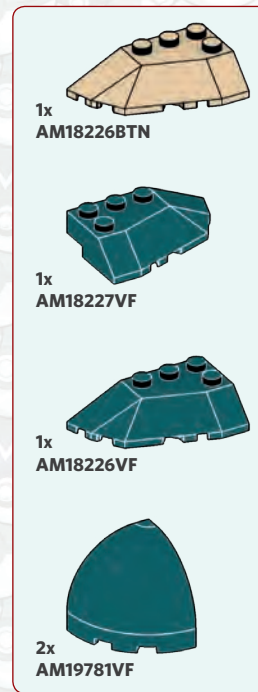
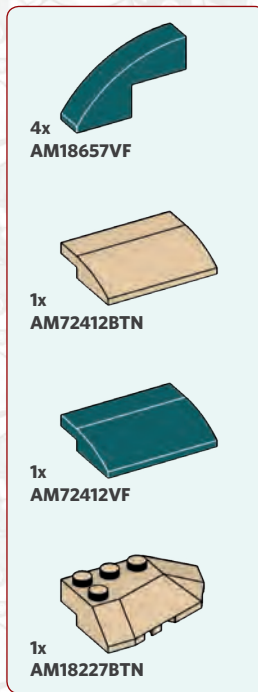
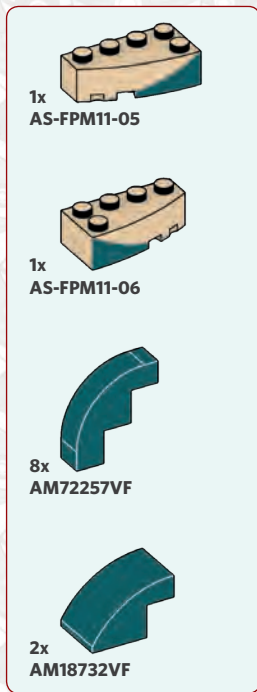
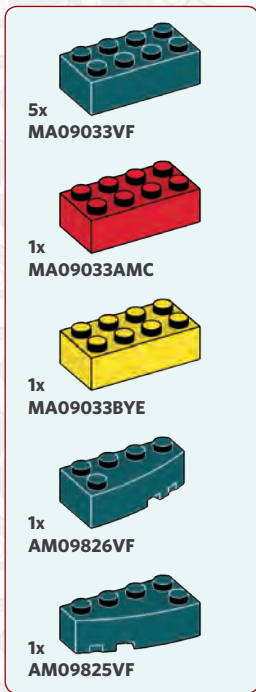

⚠ WARNING :  
CHOKING HAZARD. - Small parts.  
Not for children under 3 years.

⚠ ATTENTION :  
DANGER D'ÉTOUFFEMENT. - Présence de petits éléments.  
Ne convient pas aux enfants de moins de 3 ans.

⚠ 警告:  
嚥住危険。包含有小部件  
不适合3岁以下的孩玩。

⚠ 警告:  
のどにつまる危険。小さな部品が含まれています  
3歳以下の子供には与えないで下さい。

⚠ تحذير :  
خطر الاختناق - قطع صغيرة.  
غير صالحة للأطفال أقل من 3 سنوات.

ADVERTENCIA: Peligro de asfixia. Juguete no recomendado para menores de 3 años, porque contiene piezas pequeñas que podrían provocar asfixia en casode ser ingeridas o inhaladas por el/la niño/a.

ATENÇÃO: Não recomendável para crianças com menos de 36 meses. Contém peças pequenas capazes de criar risco de asfixia.

AVVERTENZA: Contiene pezzi di piccole dimensioni.

ACHTUNG: Kleine Teile.

OSTRZEŻENIE: Małe części

WAARSCHUWING: Kleine onderdelen

ПРЕДУПРЕЖДЕНИЕ: Мелкие детали

ADVARSSEL: Små dele.

VARNING: Smådelar

ADVARSSEL: Små deler.

VAROITUS: Pieniä osia

ΠΡΟΣΟΧΗ: Περιλαμβάνονται μικρά κομμάτια.

UYARI: BOĞULMA TEHLİKESİ - Küçük Parçalar İçerir. 3 yaşından küçük çocuklar için uygun değildir.



Please read these instructions carefully before first use and keep them for future reference.  
Il est recommandé de lire attentivement ce feuillet avant la première utilisation et de le conserver pour référence future.  
Leer estas instrucciones cuidadosamente antes de la primera utilización y guardarlas para referencia futura.  
Leia as instruções antes do primeiro uso e guarde-as para futura referência.  
Leggere le istruzioni prima di cominciare ad usare il gioco e conservarle per referenza future.  
Die Gebrauchsanleitung bitte durchlesen und aufbewahren.  
Proszę uważnie przeczytać instrukcję obsługi przed pierwszym użyciem, a następnie zachować ją na przyszłość.  
Wij raden u aan deze handleiding zorgvuldig te lezen en te bewaren voor eventuele raadpleging op een later tijdstip.  
Внимательно прочитайте инструкцию перед первым использованием и сохраните ее для дальнейшего использования.  
Vær venlig at læse disse instruktioner omhyggeligt inden ibrugtagen og opbevar dem til fremtidigt brug.  
Läs noggrant igenom dessa instruktioner innan du använder produkten för första gången och spara dem för ev. framtida frågor.  
Les disse instruksjonene nøye før første gangs bruk, og ta vare på dem for fremtidige oppslag.  
Lue nämä ohjeet huolellisesti ennen ensimmäistä käyttöä ja säilytä ne myöhempää tarvetta varten.  
Διαβάστε προσεκτικά τις οδηγίες πριν από τη χρήση και κρατήστε τις για μελλοντική αναφορά.  
İlk kullanımdan önce talimatları dikkatlice okumanızı ve bu bilgileri ileride tekrar bakabilmek için saklamanızı öneririz.  
第一次使用前，请仔细阅读本说明书并保留以备将来参考。  
初めてご使用になる前に、この説明書をよくお読みください。また、本書は将来いつでも参照できるように保管してください。  
يجب قراءة هذه التعليمات بعناية قبل الاستخدام والاحتفاظ بها للعودة إليها مستقبلاً.



Ⓟ D781,964, D786,984

Patents pending.  
Brevets en instance.

© 2017 The Pokémon Company International. © 1995–2017 Nintendo / Creatures Inc. / GAME FREAK inc. TM, ®, and character names are trademarks of Nintendo.

© 2017 The Pokémon Company International. © 1995–2017 Nintendo / Creatures Inc. / GAME FREAK inc. TM, ® et les noms des personnages sont des marques de Nintendo.

play.megaconstrux.com

1



1x



2x



1x



1x



1x



1

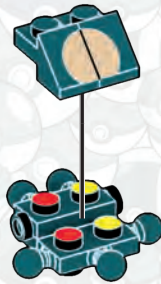

2



3

2



1x



1x



1x



1x



1x

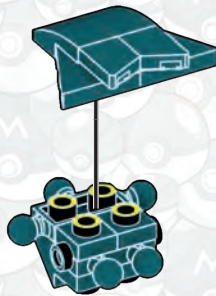
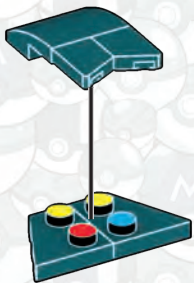

1



2

3



2x



1x

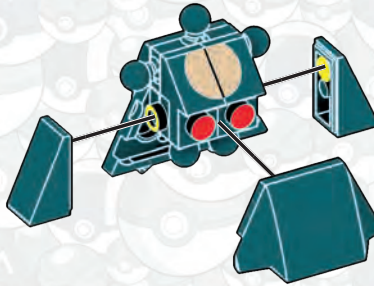

4



2x



2x



2x

x2

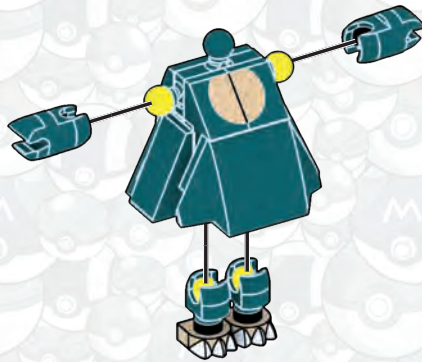

1

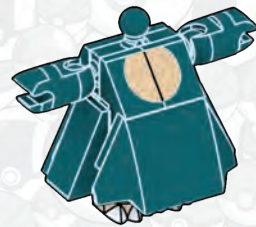

2

5



2x



1x



1x

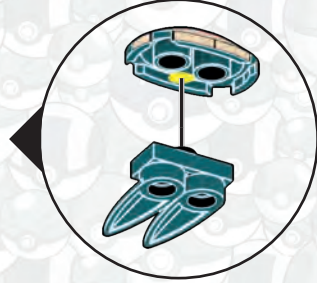
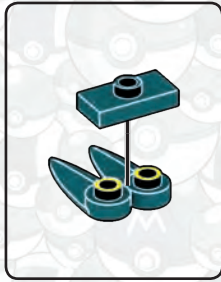

6



1x



1x

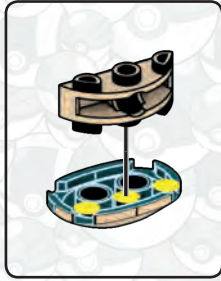

1

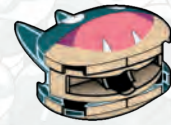

2

7

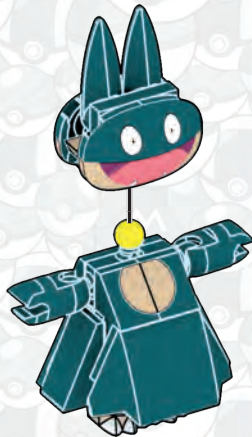

1



2

8



2x

1x



1x



1x



1x

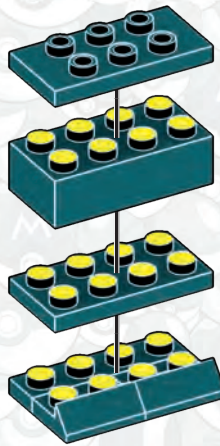

9



2x

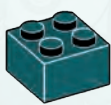

2x

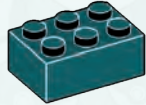

1x

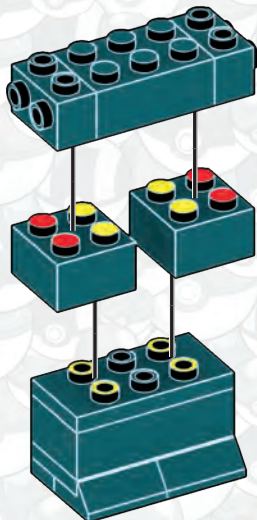

10



2x

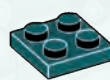

1x

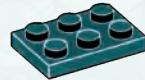

2x



2x

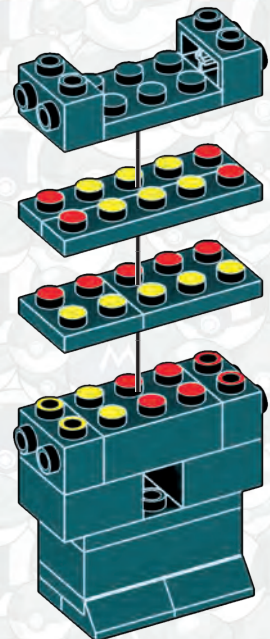

11



2x



2x

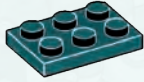

1x



2x

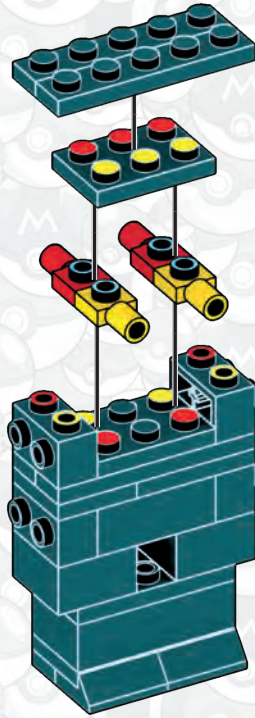

12



1x



2x



2x

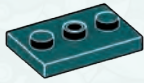

1x

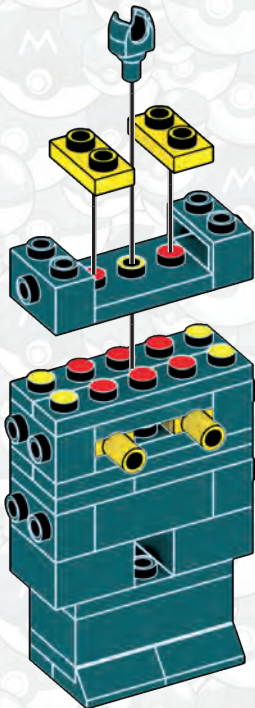



13



2x



2x



2x

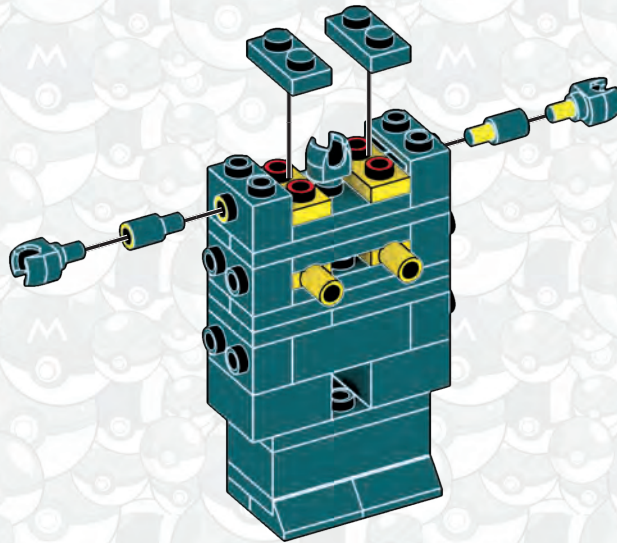

14

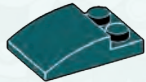

2x



2x

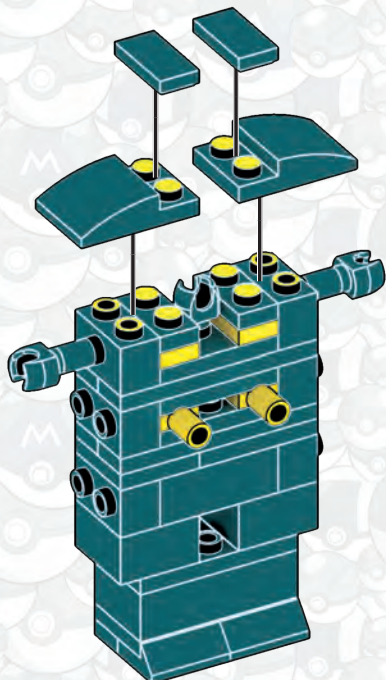

1

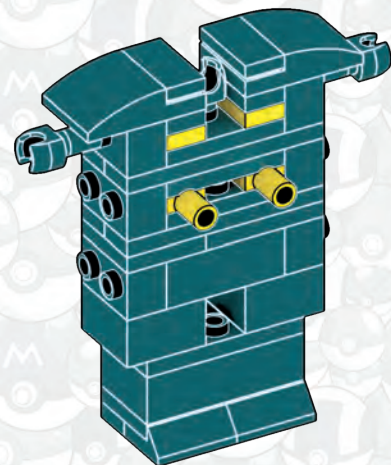

2

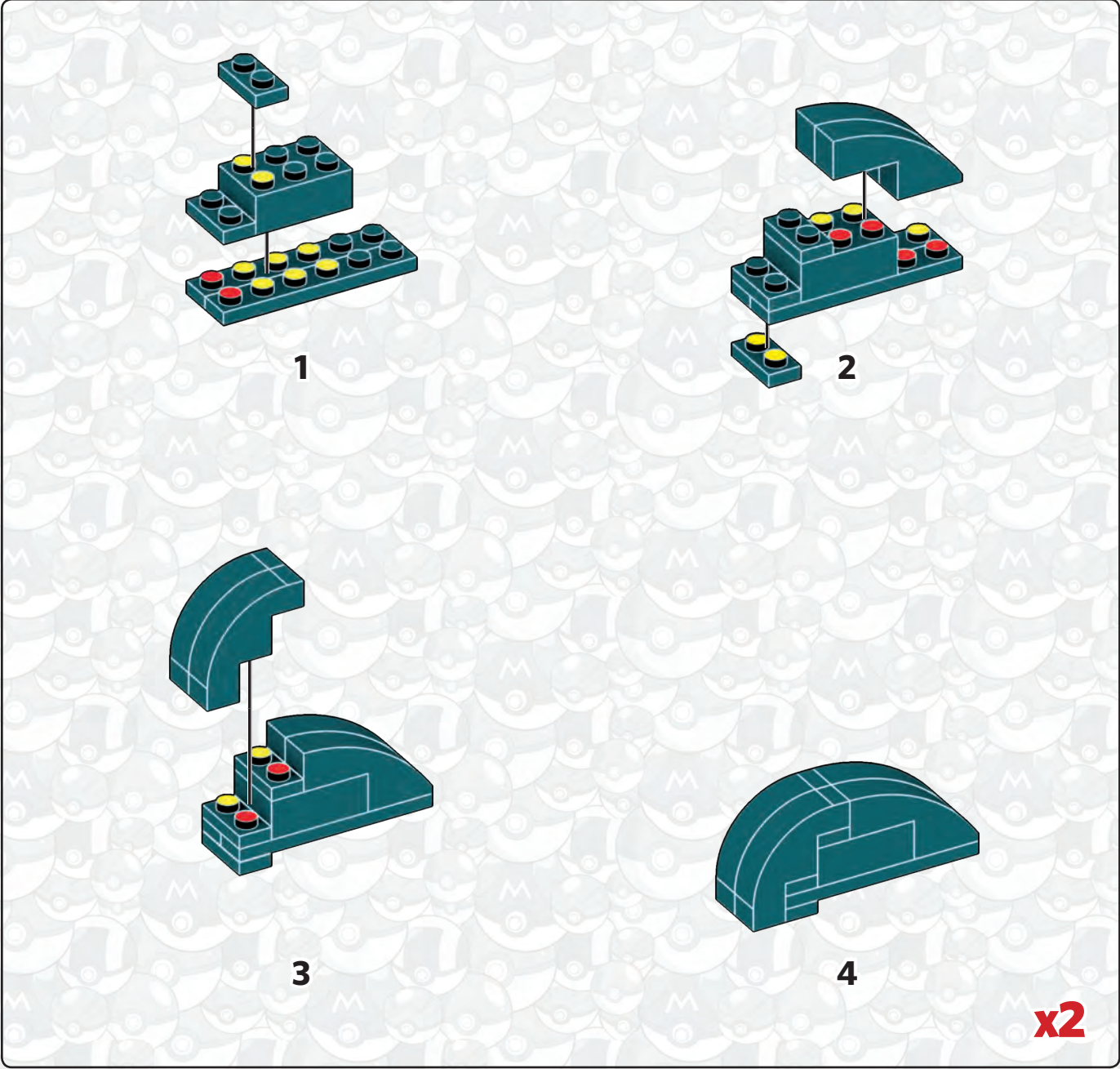
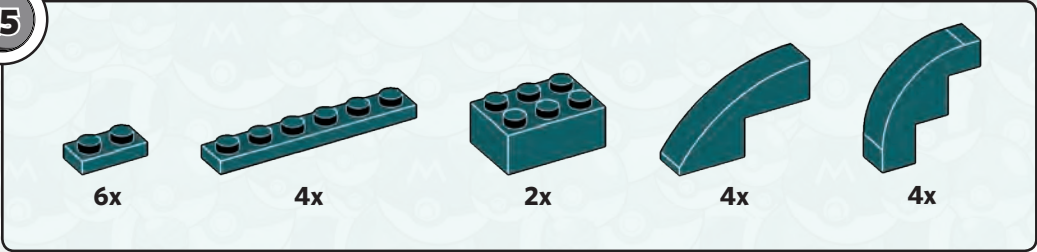

16



1x

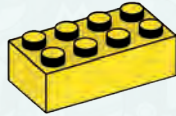

1x

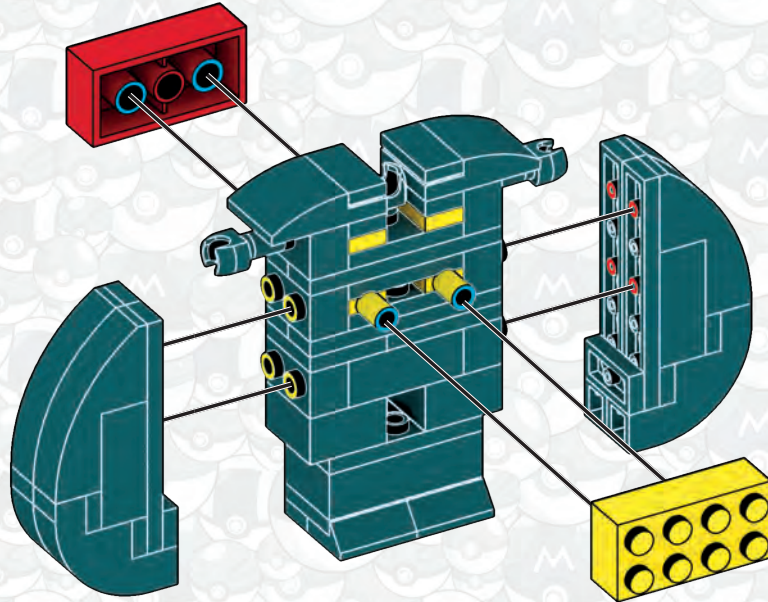

1

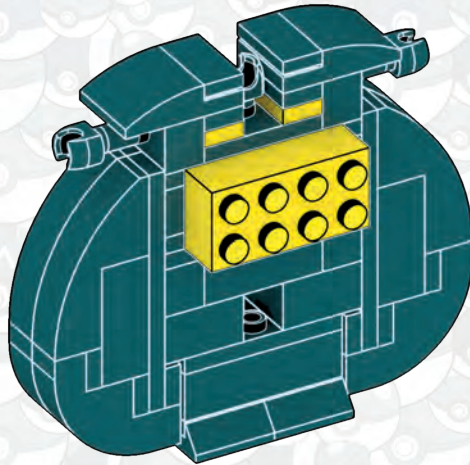

2

17

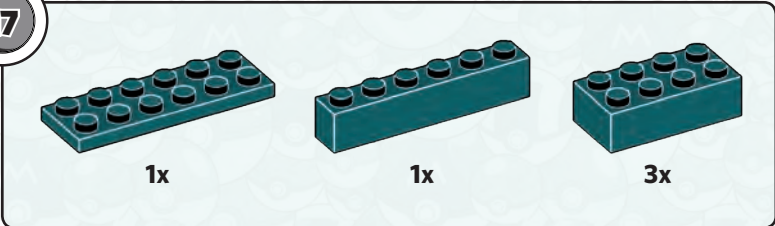

18

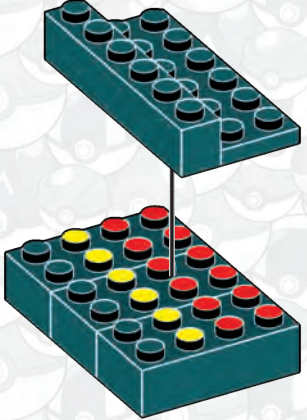
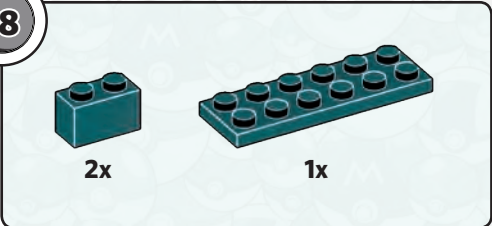

1

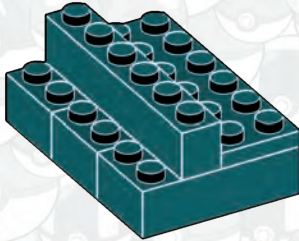

2

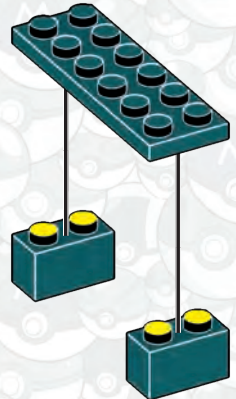

19

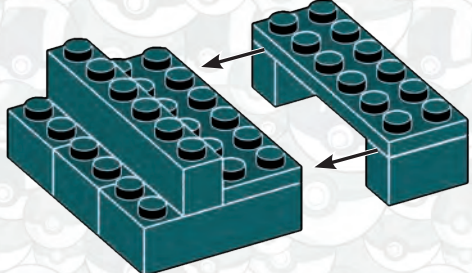
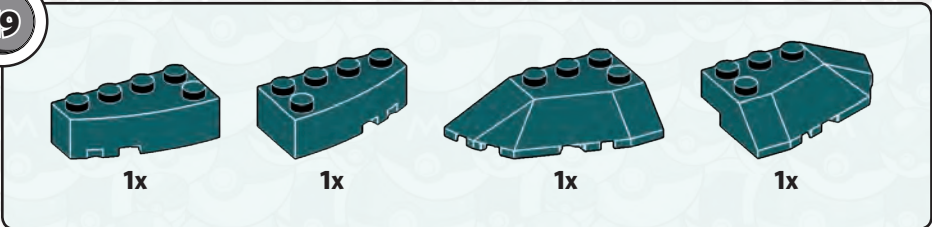

1

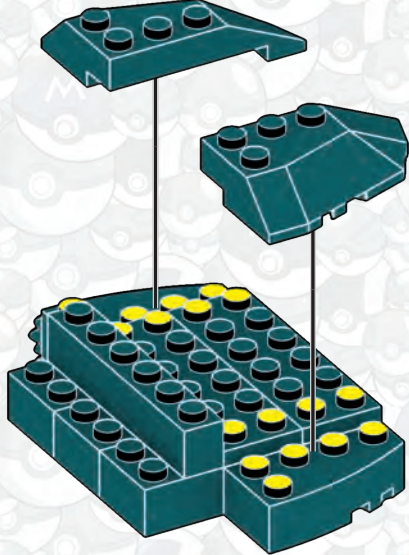

2

20

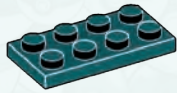

1x



2x

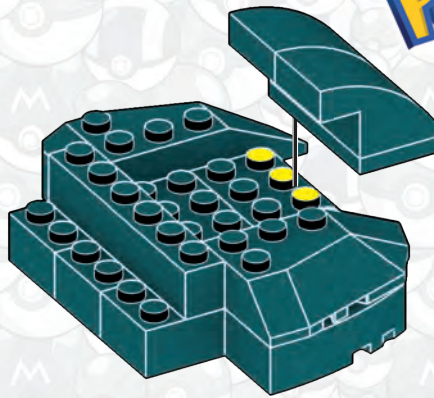
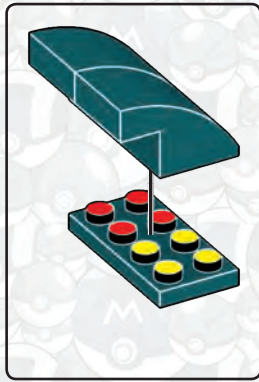

21



2x



1x



1x

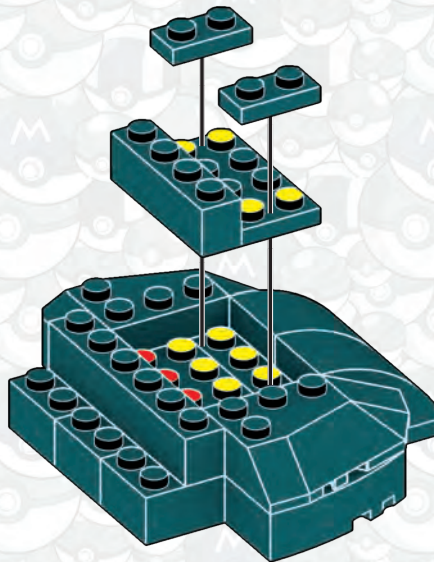

22



1x



1x

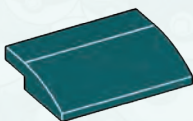

1x



23

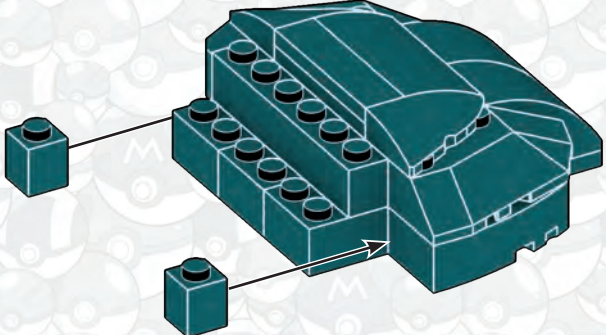
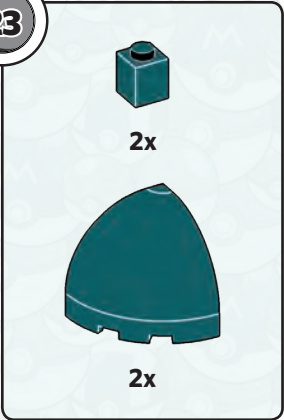

1

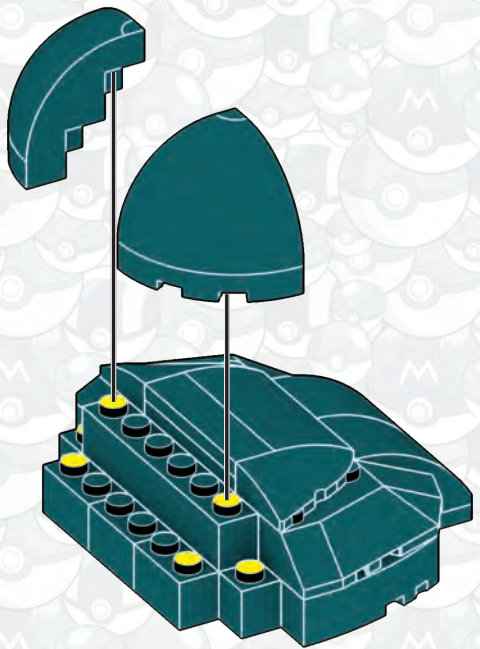

2

24

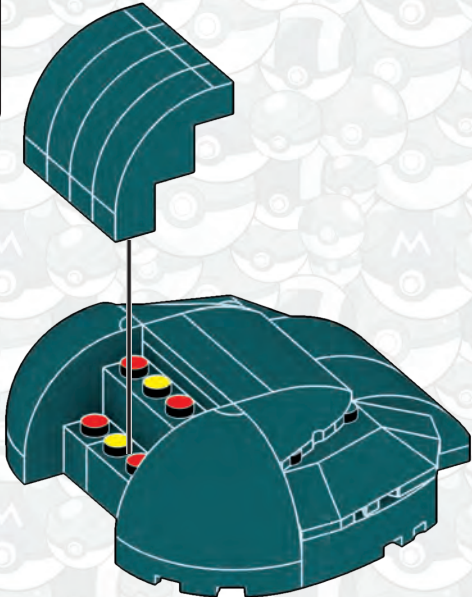

1

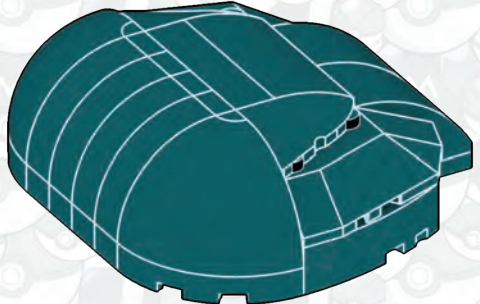

2

25



2x

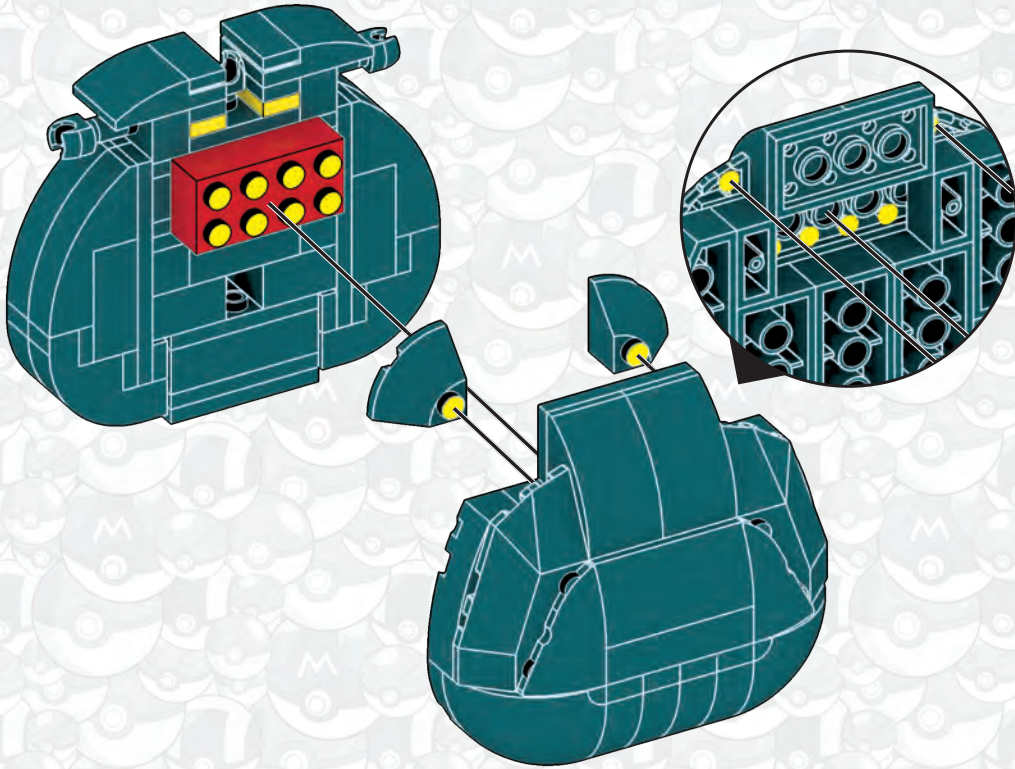

1

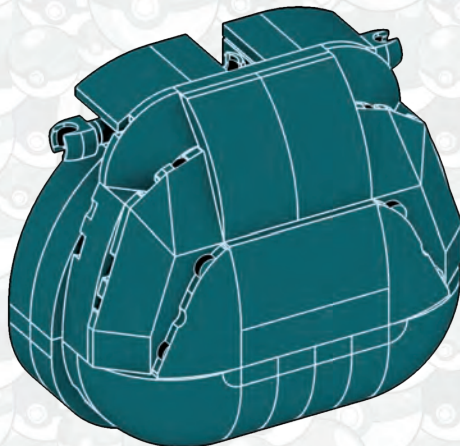

2

26

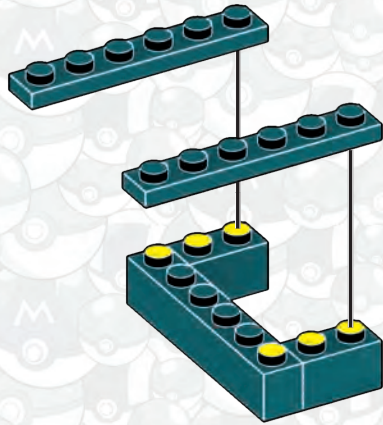
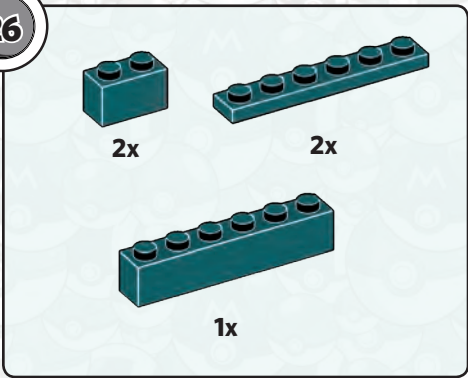

27

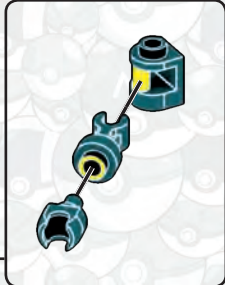
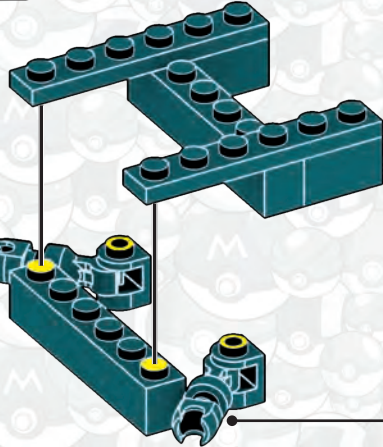
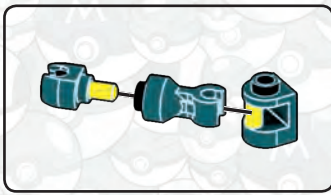

28

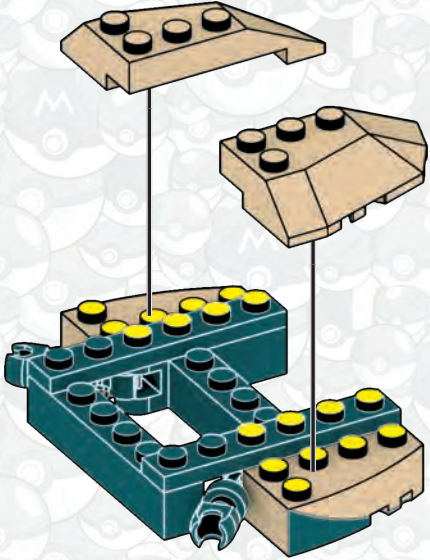
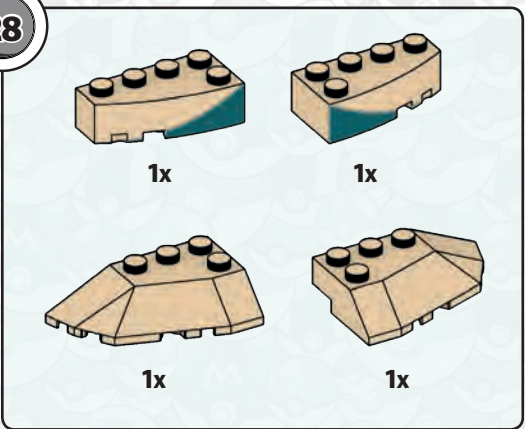



29



2x

1x

1x

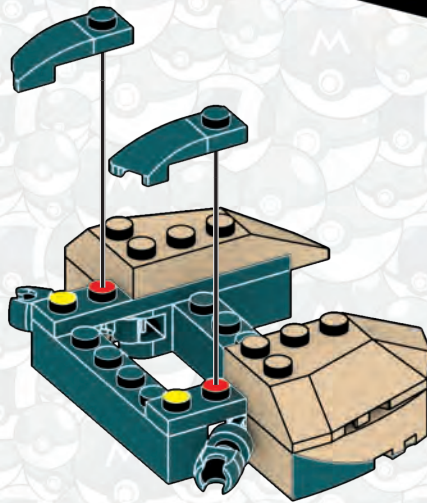

30



1x

1x

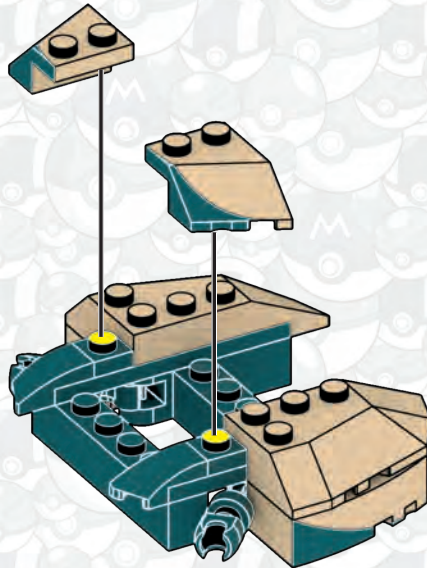

31

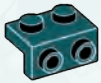

2x

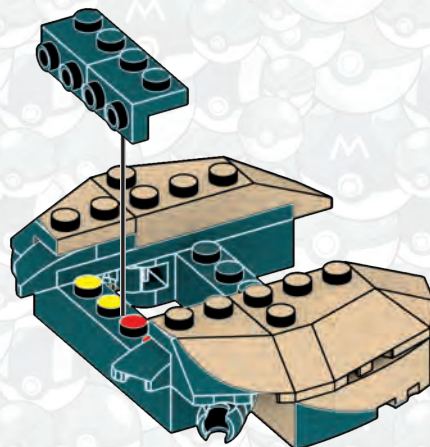

1

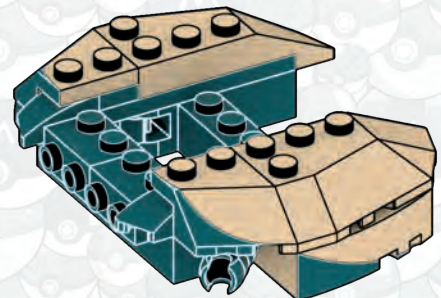

2

32

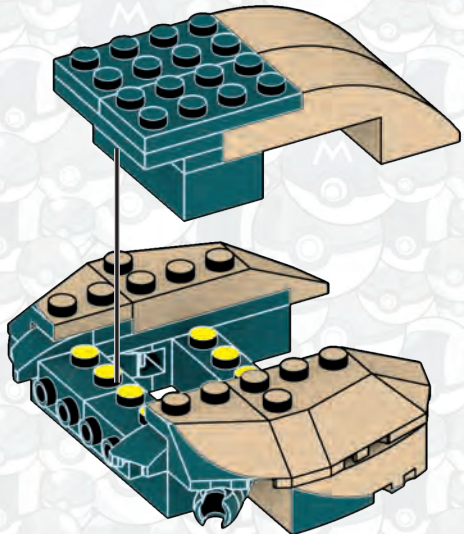
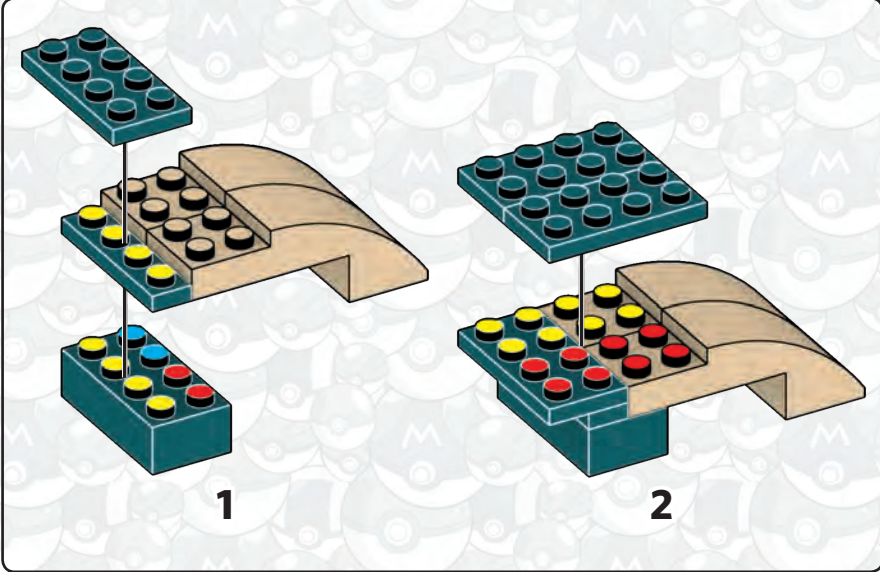
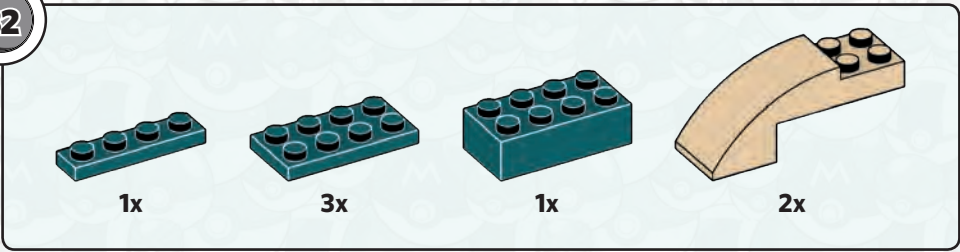

33



34

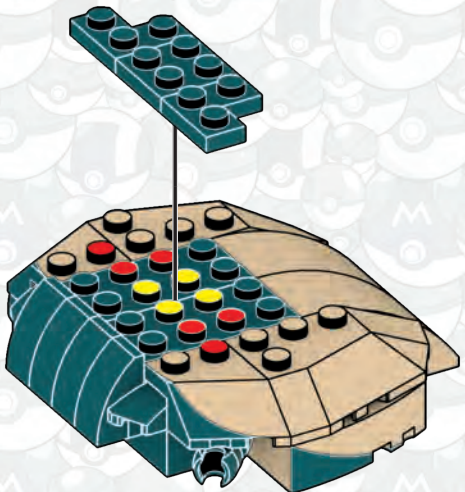
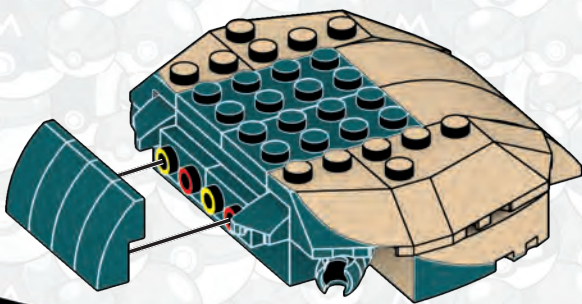
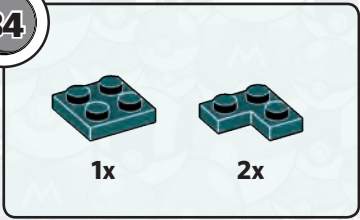

35

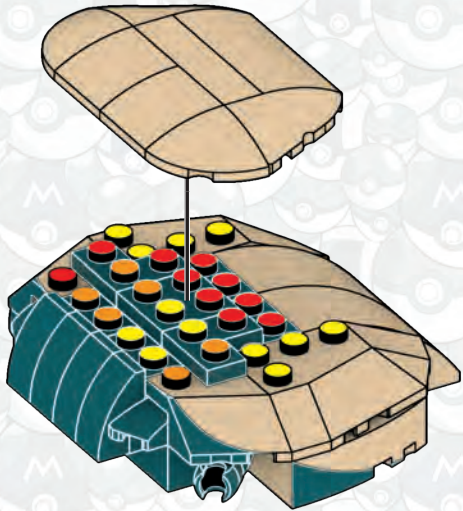
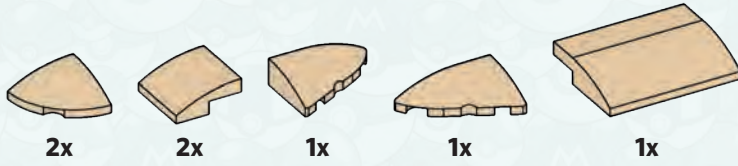

1

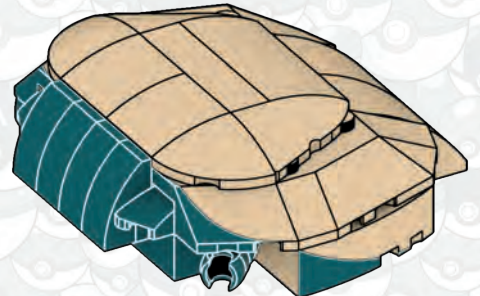

2

36



2x

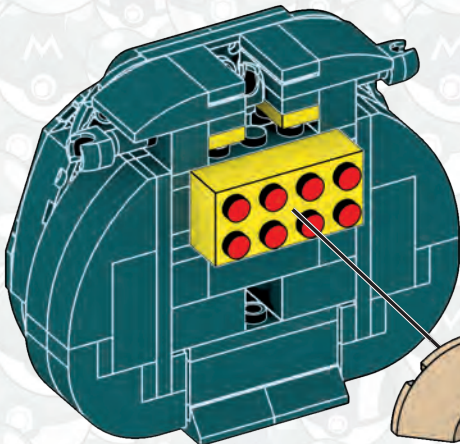

1

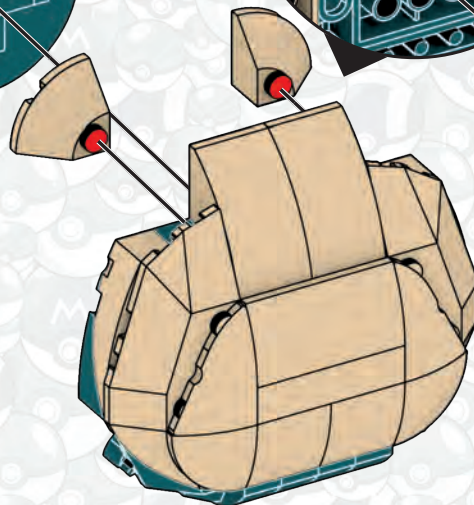
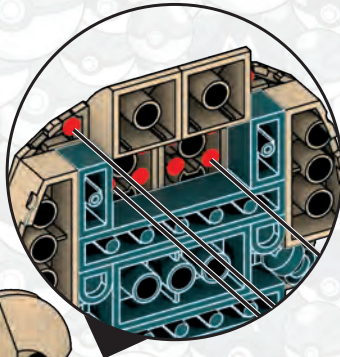

2

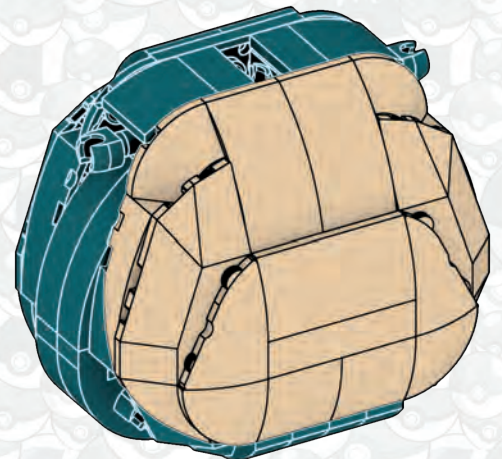

37

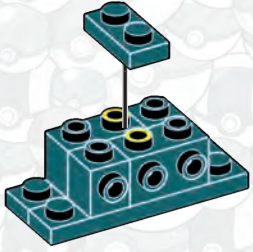
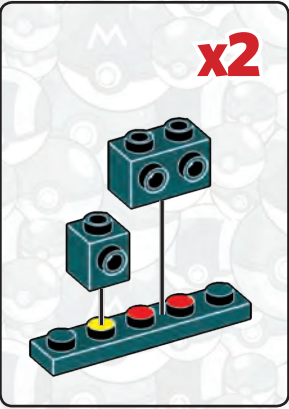
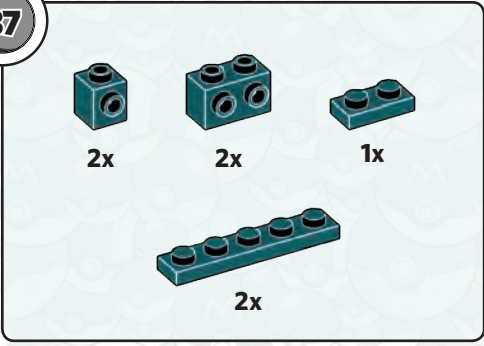

38

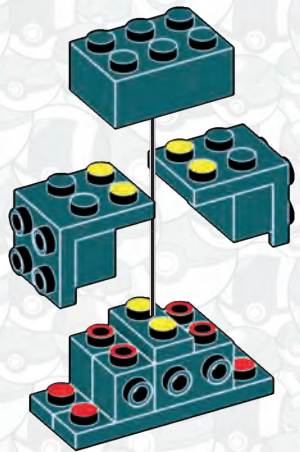
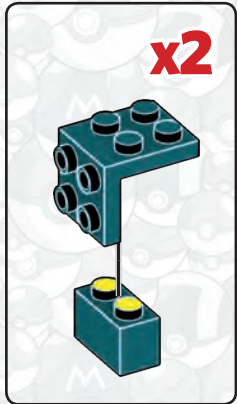
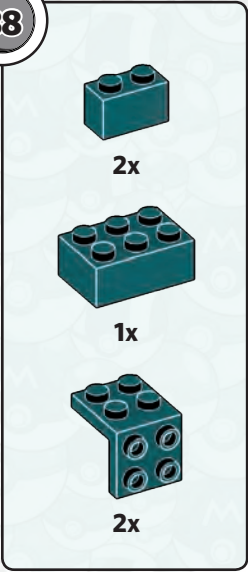

39

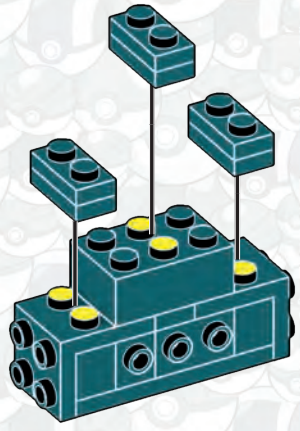
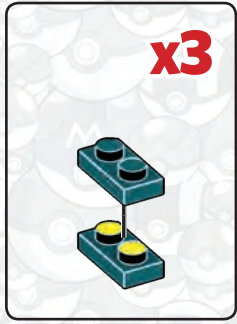

40



4x

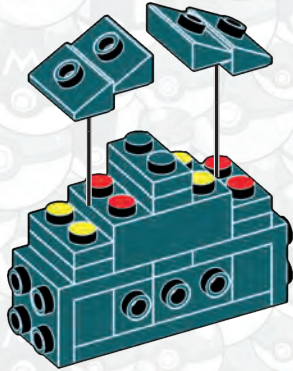

41



4x

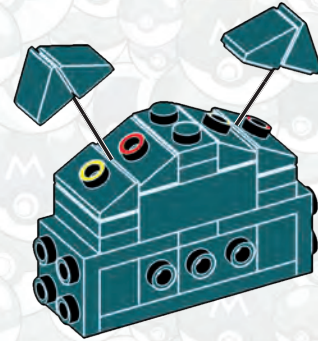

42



1x



1x

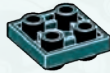

1x

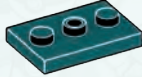

1x

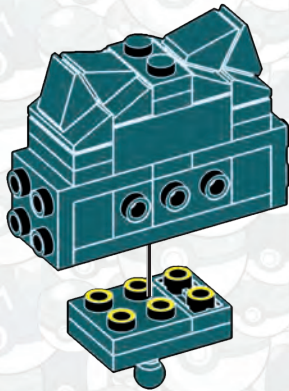
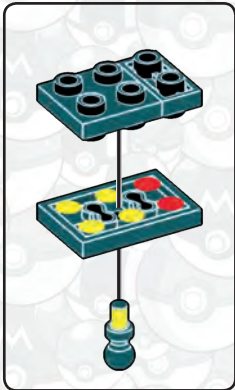

1

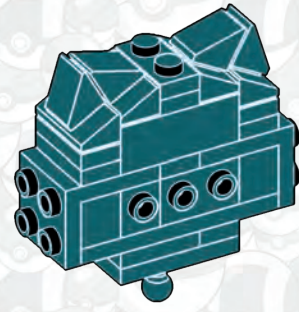

2

43



2x

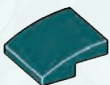

4x

x2

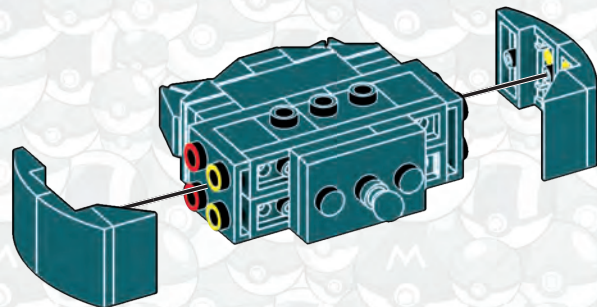
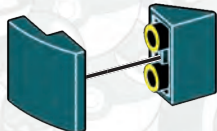

4x  
2x  
1x  
1x  
2x  
1x

This block lists the required parts for step 44: four tan 1/2 round Technic plates with two holes, two tan 1/2 round Technic plates with one hole, one tan 1/2 round Technic plate with one hole and a notch, one tan 1/2 round Technic plate with one hole and a notch, two dark green 1x2 Technic Technic plates with four holes, and one dark green 1x4 Technic Technic plate with six holes.

x2  
1 2

This diagram shows the assembly of a sub-component. It consists of a tan 1/2 round Technic plate with two holes (part 1) and a tan 1/2 round Technic plate with one hole and a notch (part 2). Two yellow Technic pins are inserted into the holes of part 1, and the two pins are then inserted into the holes of part 2. This assembly is shown to be repeated twice (x2).

1 2

This diagram shows the assembly of another sub-component. It consists of a tan 1/2 round Technic plate with two holes (part 1) and a tan 1/2 round Technic plate with one hole and a notch (part 2). Two yellow Technic pins are inserted into the holes of part 1, and the two pins are then inserted into the holes of part 2.

1 2

This diagram shows the assembly of a third sub-component. It consists of a tan 1/2 round Technic plate with one hole and a notch (part 1) and a tan 1/2 round Technic plate with one hole and a notch (part 2). Two yellow Technic pins are inserted into the holes of part 1, and the two pins are then inserted into the holes of part 2.

This diagram shows the main assembly process. A dark green 1x4 Technic Technic plate with six holes is being inserted into a larger dark green Technic component. A dark green 1x2 Technic Technic plate with four holes is being inserted into the top of the 1x4 plate. Two tan 1/2 round Technic plates with one hole and a notch (part 2) are being inserted into the top of the 1x2 plate. A tan 1/2 round Technic plate with two holes (part 1) is being inserted into the top of the 1x4 plate. A circular inset provides a magnified view of the top of the assembly, showing the tan 1/2 round Technic plates with one hole and a notch (part 2) and the tan 1/2 round Technic plate with two holes (part 1) being inserted into the dark green Technic plates.

45

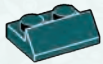

1x



1x



1x



1x

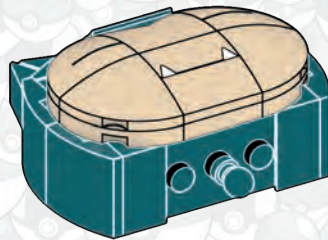
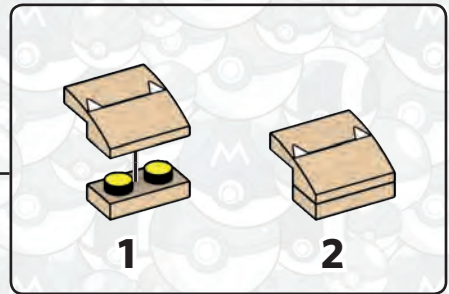
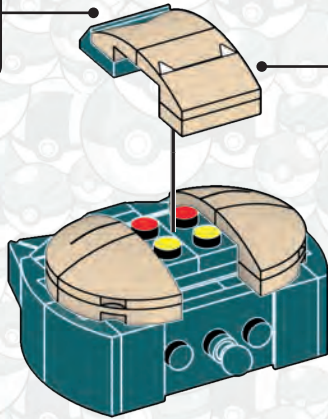
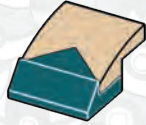
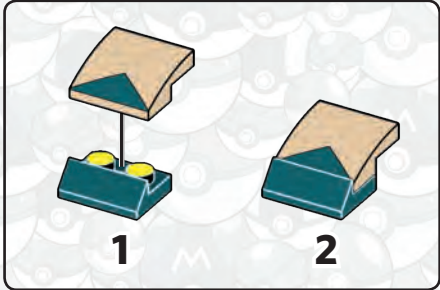

1

2

46

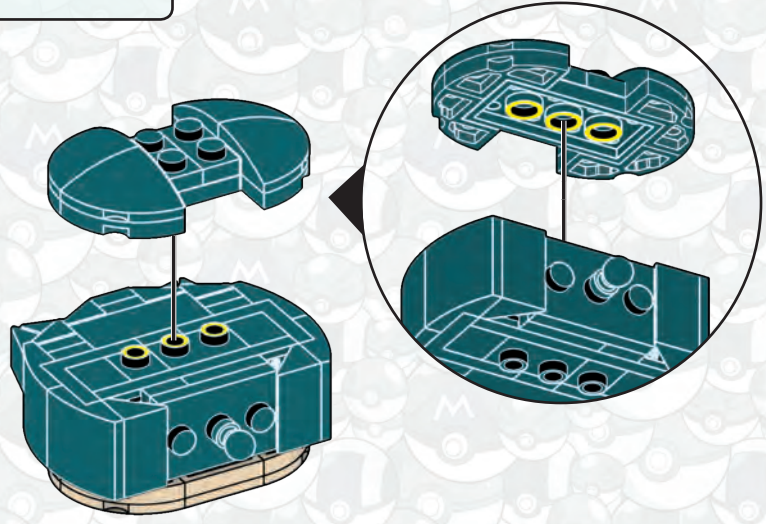
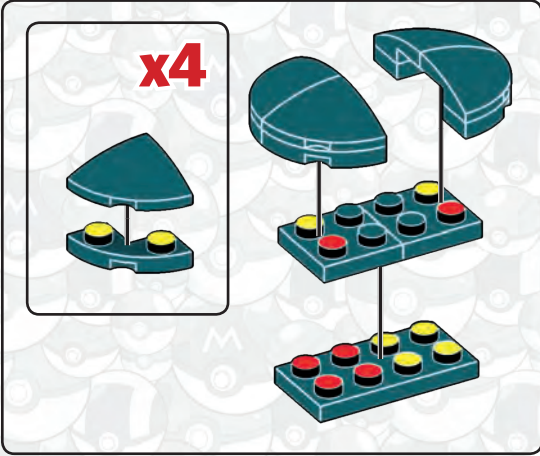

47

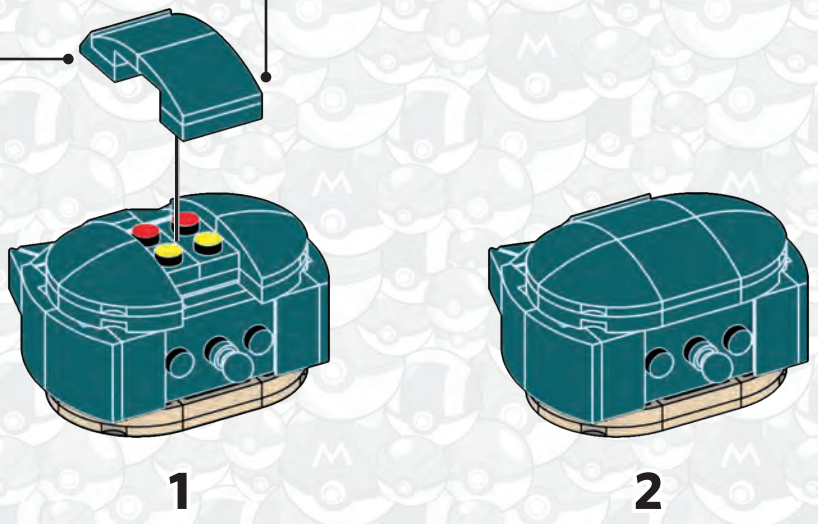
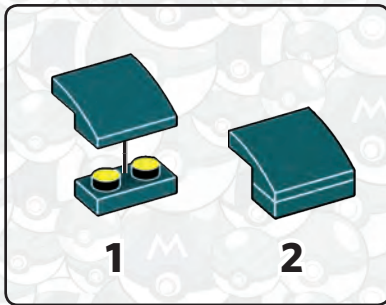
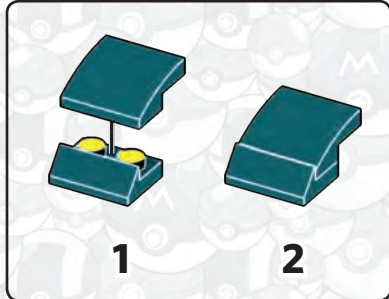



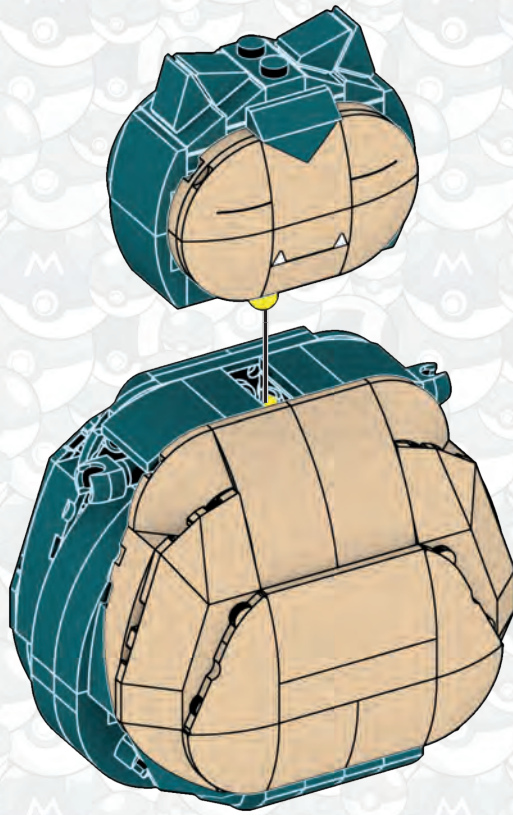

1

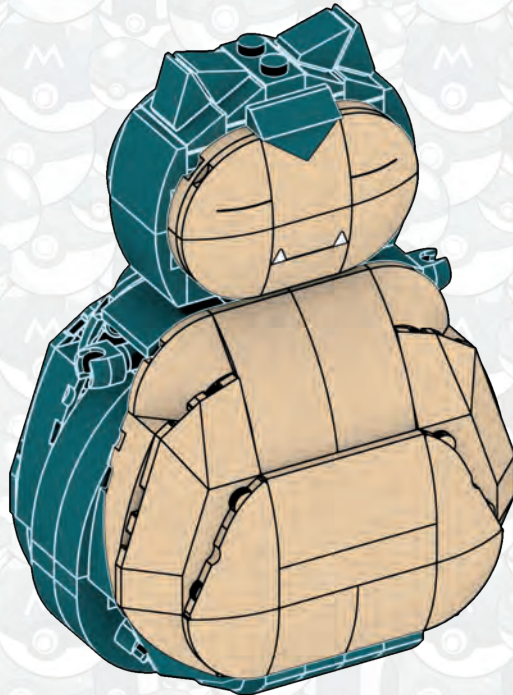

2

49

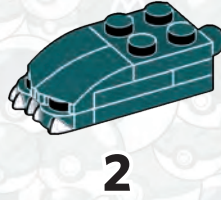
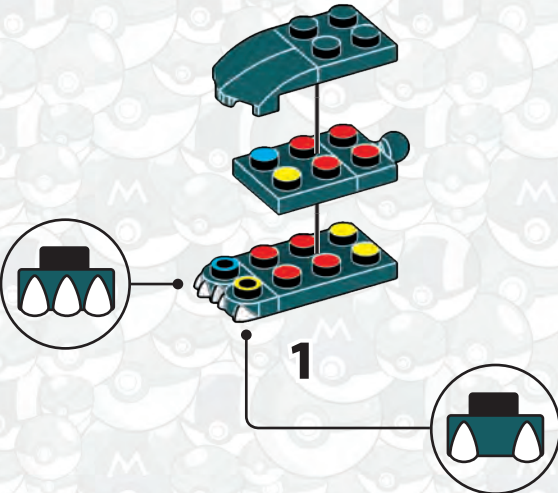
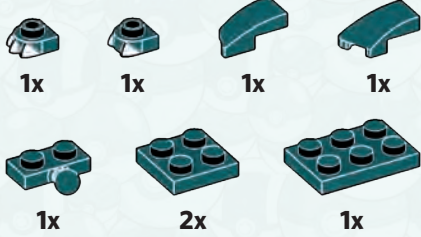

50

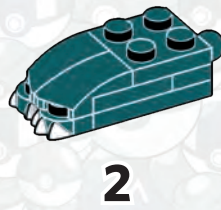
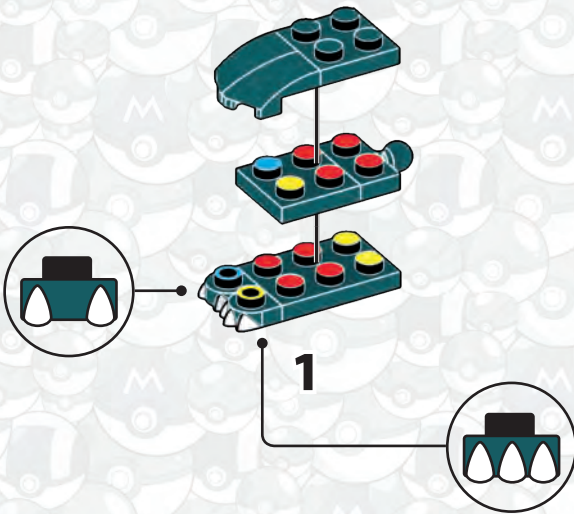
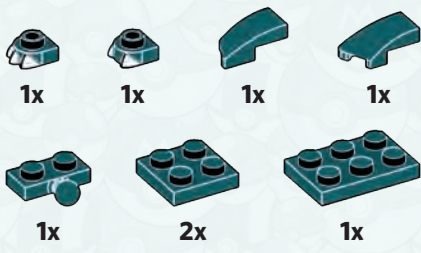

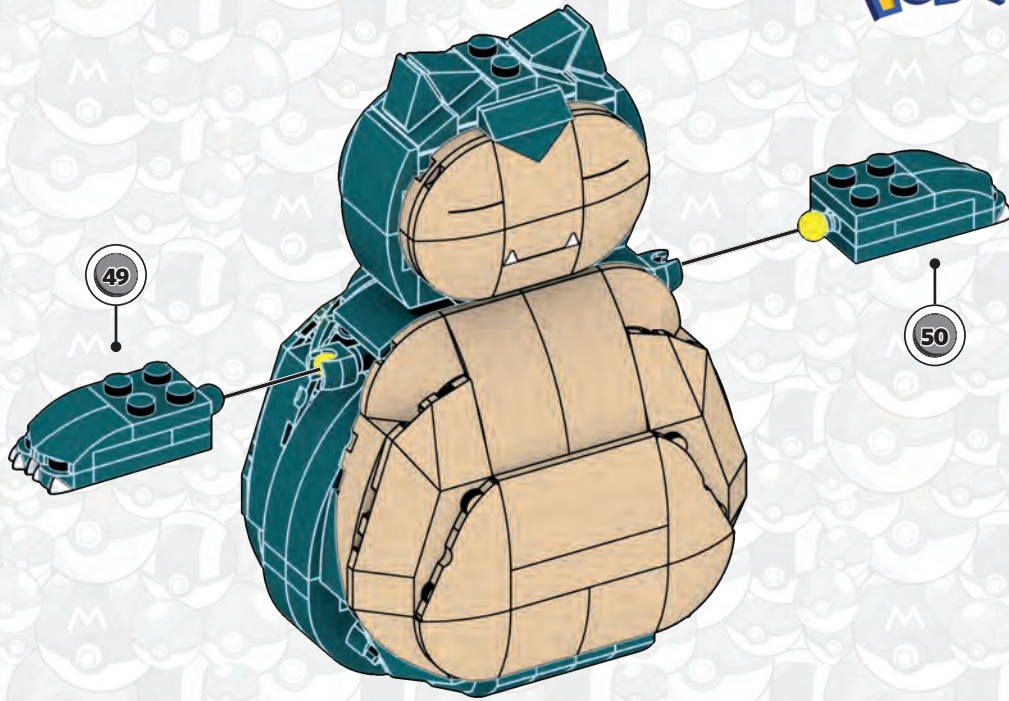

1

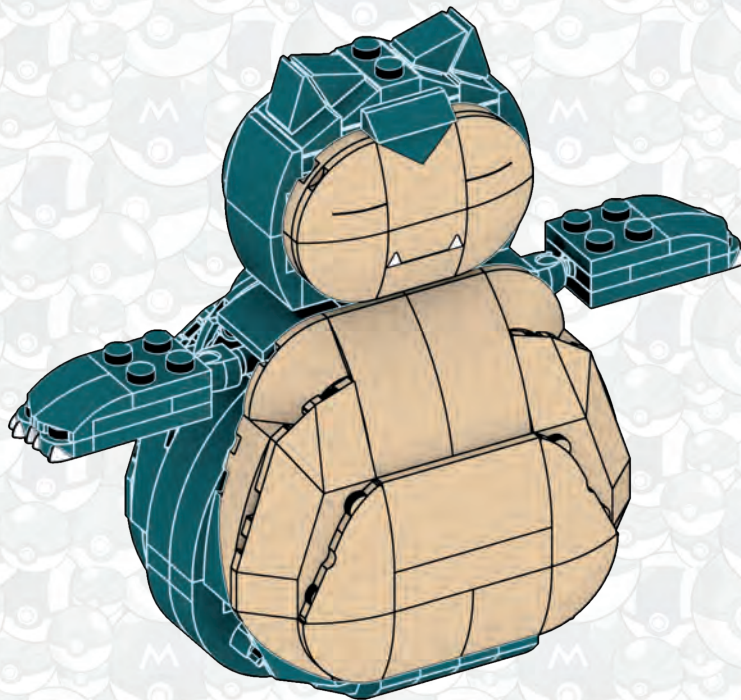

2

52



1



2



3

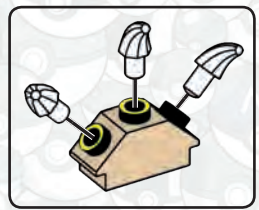

4



5

53



1



2



3

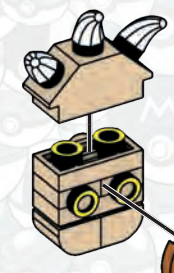
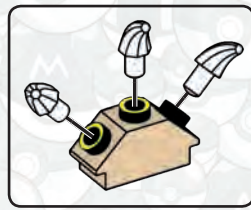

4



5

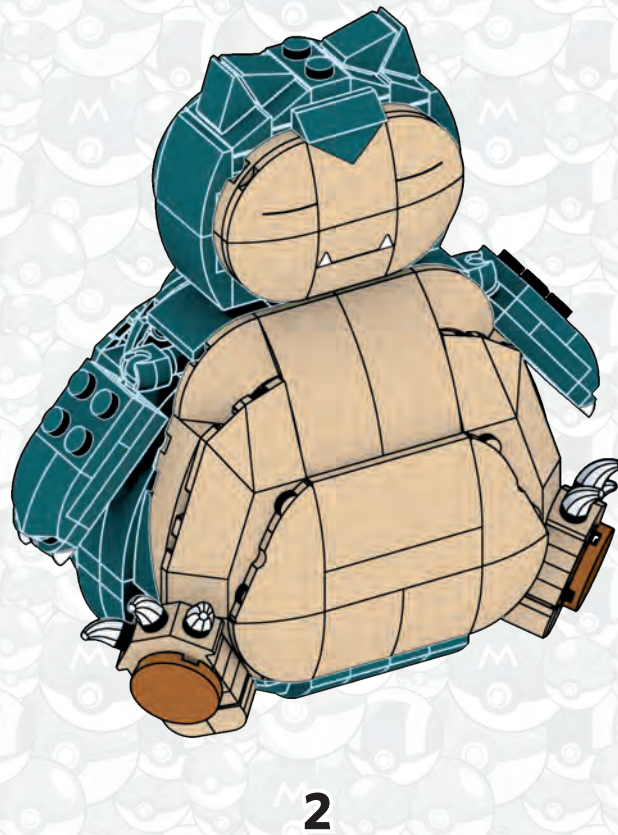
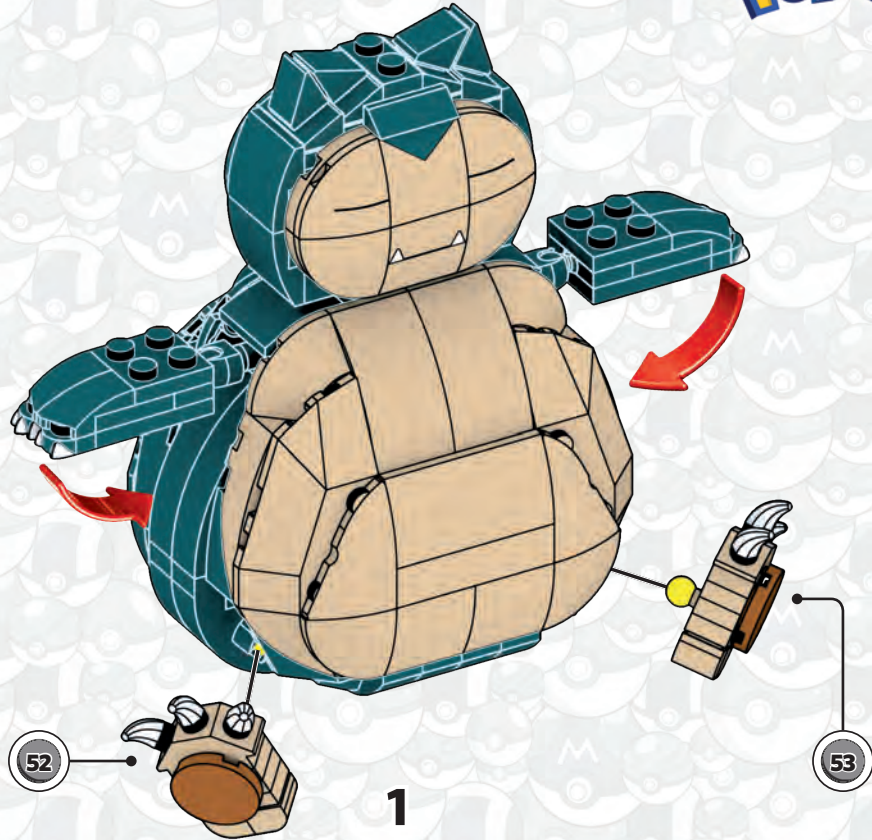





# MEGA CONSTRUX™

Build Beyond™

Au-delà de la  
construction!

¡Construye sin límites!

Mais do que Construção!

Costruisci oltre ogni limite!

Es gibt keine Grenzen!

Więcej niż budowanie!

Meer dan alleen bouwen!

Больше, чем конструктор!

Χτίσε έναν ολόκληρο κόσμο!

Hayallerini İnşa Et!

للتبني... وواكثر!



[play.megaconstrux.com](http://play.megaconstrux.com)

©2017, MEGA Brands Inc. &™ MEGA Brands Inc. CONSTRUX™ is owned by Mattel and used under license. CONSTRUX™ appartient à Mattel et est utilisée sous licence. Printed in Canada D-FPM11-01