



**INSTRUCTIONS  
INSTRUCCIONES  
MODE D'EMPLOI  
INSTRUÇÕES**



COLORS AND DECORATIONS MAY VARY.  
• LOS COLORES Y DECORACIONES  
PUEDEN VARIAR DE LOS MOSTRADOS. • LES  
COULEURS ET LES MOTIFS PEUVENT VARIER.  
• AS CORES E AS DECORAÇÕES PODEM VARIAR.

PLEASE KEEP THESE INSTRUCTIONS FOR FUTURE  
REFERENCE AS THEY CONTAIN IMPORTANT  
INFORMATION. • LEE Y GUARDA ESTAS  
INSTRUCCIONES PARA FUTURA REFERENCIA, YA QUE  
CONTIENEN INFORMACIÓN DE IMPORTANCIA DE ESTE  
PRODUCTO. • CONSERVER CE MODE D'EMPLOI POUR S'Y  
RÉFÉRER AU BESOIN CAR IL CONTIENT DES  
INFORMATIONS IMPORTANTES. • POR FAVOR, GUARDE  
ESTAS INSTRUÇÕES PARA FUTURA REFERÊNCIA, POIS  
CONTÉM INFORMAÇÕES IMPORTANTES.

**5-8**

service.mattel.com  
**HOTWHEELS.COM**



FTB68-4B70-G1  
1101721206\_4LB

**CONTENTS · CONTENIDO**  
**CONTENU · CONTEÚDO**

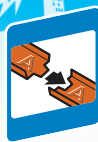

Refer to **LETTERS** on parts for easy assembly.

Usa como guía las **LETRAS** en las piezas para facilitar el montaje.

Se référer aux **LETTRES** sur les pièces pour faciliter l'assemblage.

Confira as **LETRAS** moldadas nas peças para montar com mais praticidade.

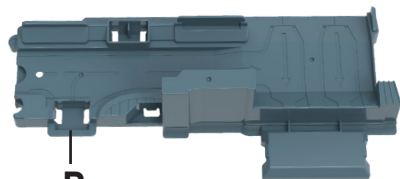
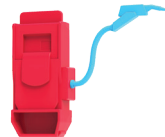
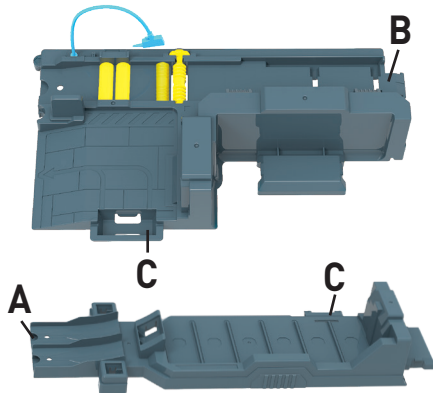

**NOTE:** APPLY LABELS DURING ASSEMBLY. • **ATENCIÓN:** PEGA LAS CALCOMANÍAS DURANTE EL MONTAJE. • **REMARQUE :** APOSER LES AUTOCOLLANTS DURANT L'ASSEMBLAGE. • **NOTA:** APLIQUE OS ADESIVOS DURANTE A MONTAGEM.

**ASSEMBLY · MONTAJE  
ASSEMBLAGE · MONTAGEM**

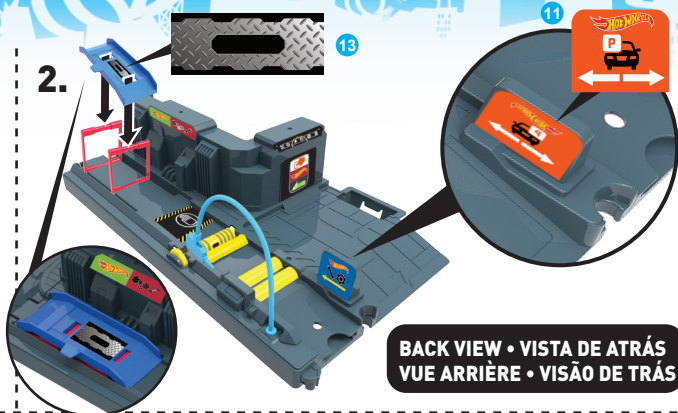
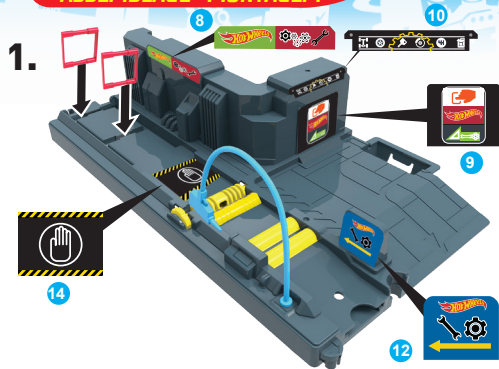

**BACK VIEW · VISTA DE ATRÁS  
VUE ARRIÈRE · VISÃO DE TRÁS**

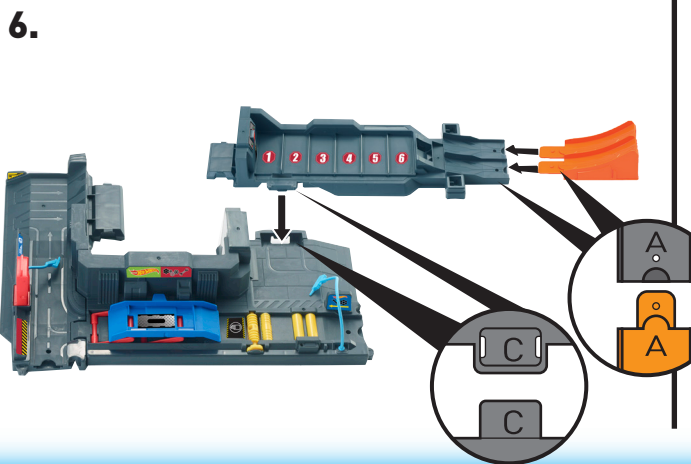
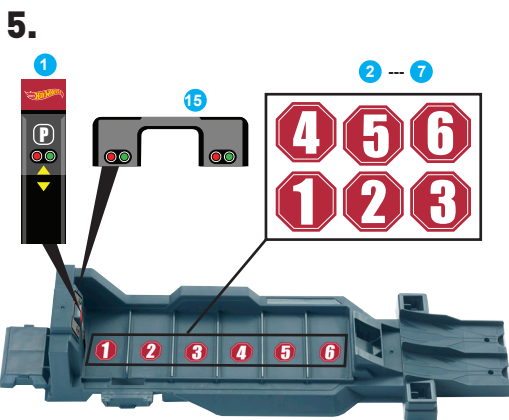
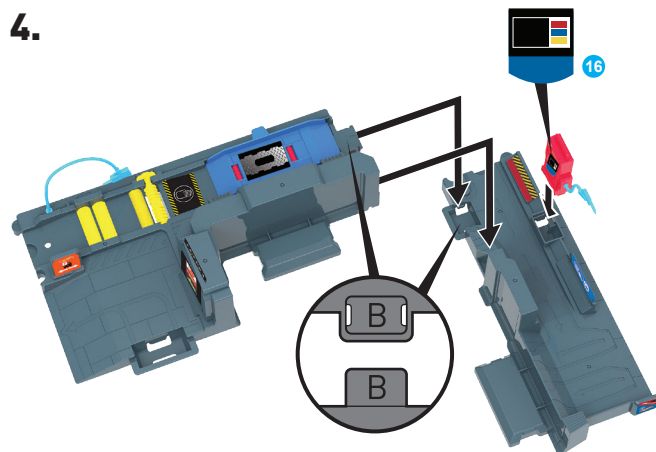
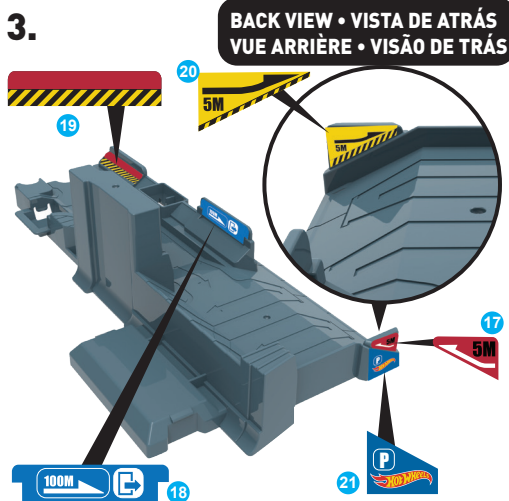

7.

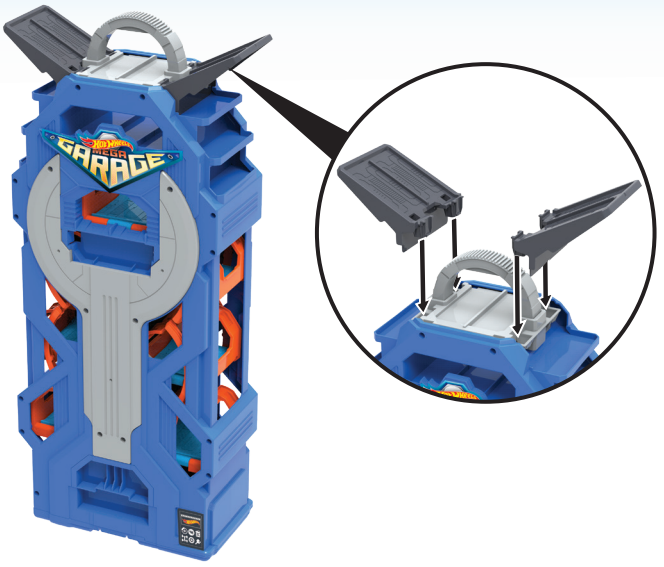

8.

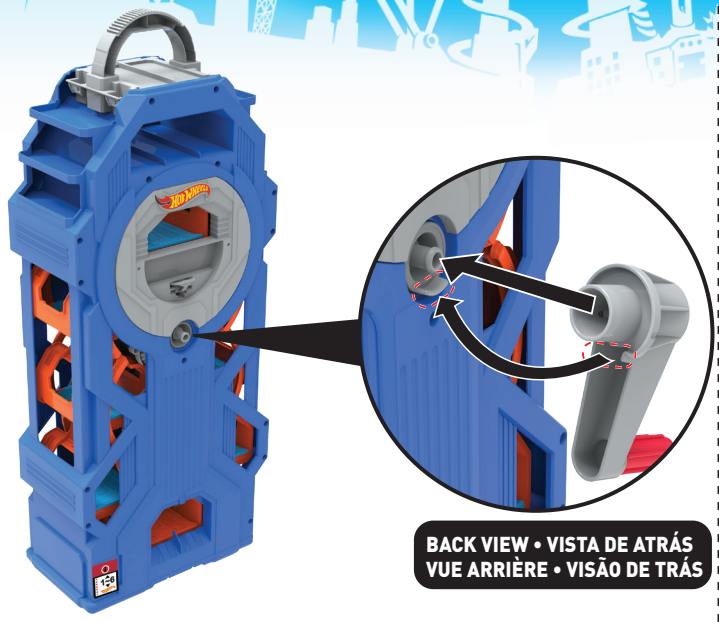

9.



10.

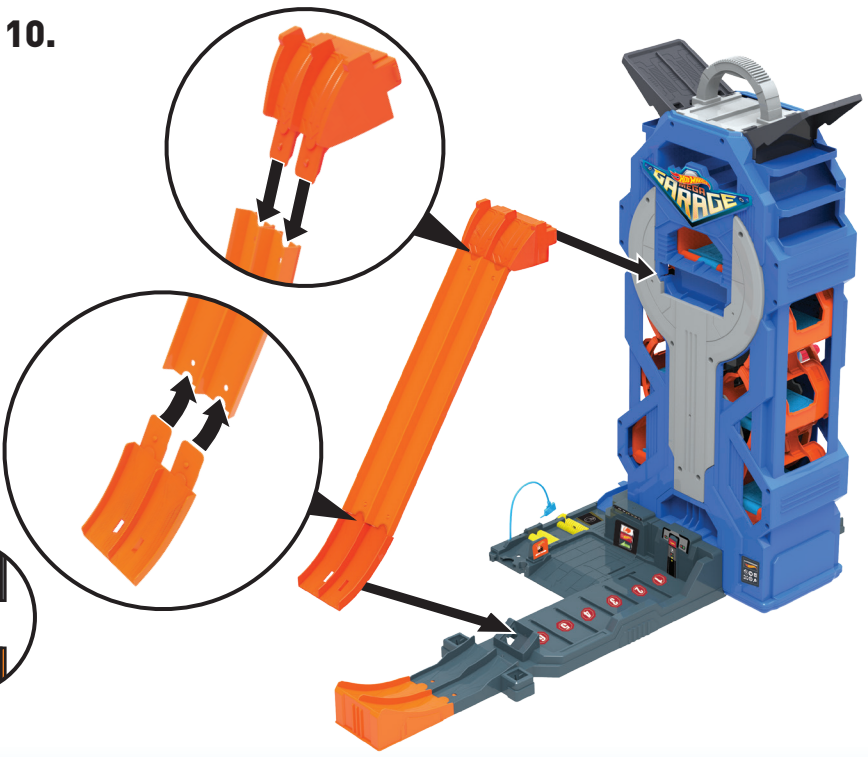

11.



12.



**TO PLAY · PARA JUGAR  
POUR JOUER · COMO BRINCAR**

- 1. DRIVE IN & WORK ON YOUR VEHICLES. • ENTRA MANEJANDO Y REPARA LOS VEHÍCULOS. • ENTRER ET TRAVAILLER SUR LES VÉHICULES. • ENTRE E TRABALHE NOS SEUS VEÍCULOS.**

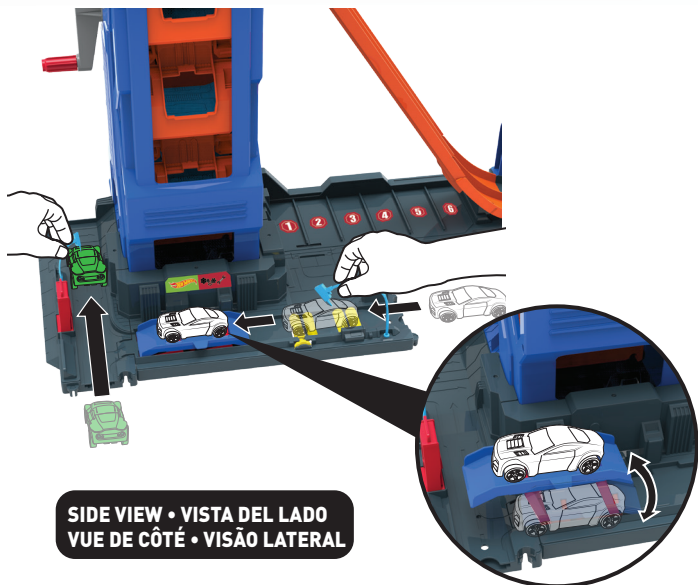

- 2. LOAD VEHICLES INTO THE GARAGE. • METE LOS VEHÍCULOS EN EL GARAGE. • PLACER LES VÉHICULES DANS LE GARAGE. • COLOQUE OS VEÍCULOS NA GARAGEM.**

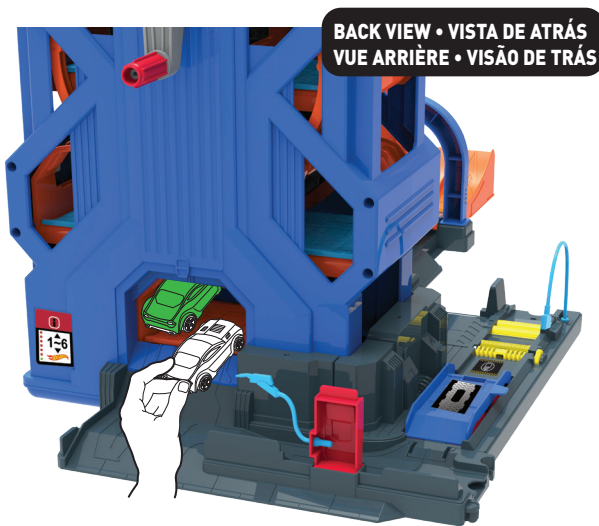

**NOTE: LOAD UP TO 2 VEHICLES AT A TIME.  
ATENCIÓN: METE HASTA 2 VEHÍCULOS A LA VEZ.  
REMARQUE: PLACER JUSQU'À 2 VÉHICULES À LA FOIS.  
NOTA: COLOQUE ATÉ 2 VEÍCULOS POR VEZ.**

- 3. TURN THE CRANK EITHER WAY TO MOVE YOUR VEHICLES UP TO THE LAUNCH PLATFORM. • GIRA LA MANIVELA EN CUALQUIER DIRECCIÓN PARA MOVER LOS VEHÍCULOS A LA PLATAFORMA DE LANZAMIENTO. • TOURNER LA MANIVELLE DANS UN SENS OU L'AUTRE POUR FAIRE MONTER LES VÉHICULES SUR LA PLATEFORME DE LANCEMENT. • VIRE A ALAVANCA PARA QUALQUER LADO PARA MOVER OS VEÍCULOS ATÉ A PLATAFORMA DE LANÇAMENTO.**

**BACK VIEW · VISTA DE ATRÁS  
VUE ARRIÈRE · VISÃO DE TRÁS**



- 4. PRESS TO LAUNCH A SIDE-BY-SIDE RACE! • ¡PRESIONA PARA LANZAR LOS AUTOS EN UNA CARRERA LADO A LADO! • APPUYER POUR LANCER UNE COURSE CÔTÉ À CÔTÉ. APERTE PARA LANÇAR UMA CORRIDA LADO A LADO!**

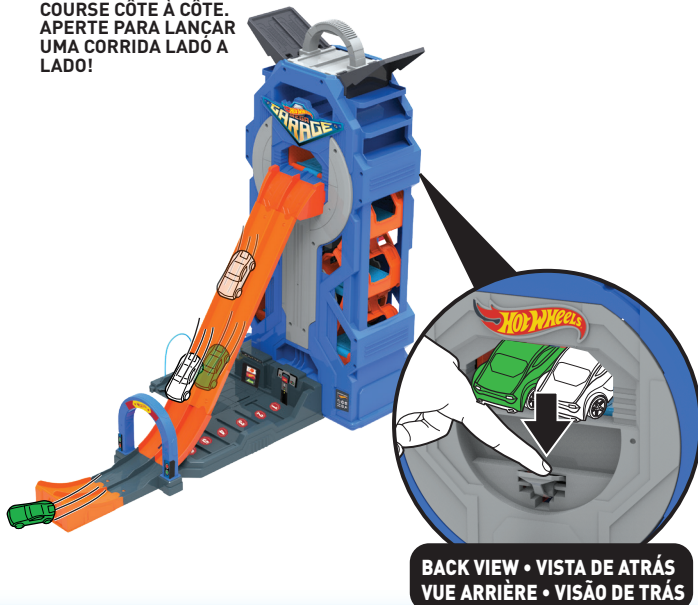

STORAGE · ALMACENAMIENTO  
RANGEMENT · PARA GUARDAR

STORE & DISPLAY UP TO **35 VEHICLES!**  
¡GUARDA HASTA **35 VEHÍCULOS!**  
RANGER ET EXPOSER JUSQU'À **35 VÉHICULES.**  
GUARDE E EXIBA ATÉ **35 VEÍCULOS!**



NOT FOR USE WITH SOME HOT WHEELS® VEHICLES. ONE VEHICLE INCLUDED.  
ADDITIONAL VEHICLES SOLD SEPARATELY. • NO COMPATIBLE CON ALGUNOS VEHÍCULOS HOT WHEELS.  
INCLUYE UN VEHÍCULO. LOS VEHÍCULOS ADICIONALES SE VENDEN POR SEPARADO. • NON COMPATIBLE  
AVEC CERTAINS VÉHICULES HOT WHEELS. CONTIENT UN VÉHICULE. AUTRES VÉHICULES VENDUS  
SÉPARÉMENT. • NÃO É COMPATÍVEL COM ALGUNS VEÍCULOS HOT WHEELS. UM VEÍCULO INCLUÍDO.  
VEÍCULOS ADICIONAIS VENDIDOS SEPARADAMENTE.

**MORE WAYS TO PLAY · MÁS MANERAS DE JUGAR  
AUTRES FAÇONS DE JOUER · OUTRAS MANEIRAS DE BRINCAR**

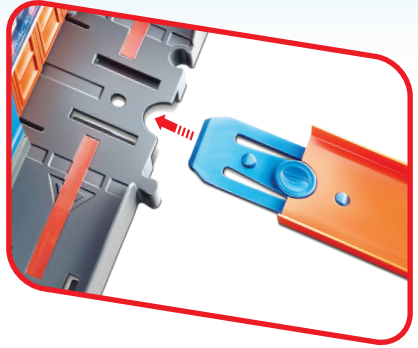

1. **CONNECT TO HOT WHEELS® TRACKS & SETS. • CONÉCTALO A PISTAS Y SETS HOT WHEELS.  
SE CONECTE AUX PISTES ET COFFRETS DE JEU HOT WHEELS. • CONECTE A OUTROS CONJUNTOS E PISTAS HOT WHEELS.**
2. **COLLECT OTHER SETS TO BUILD YOUR OWN HOT WHEELS™ CITY!  
¡COLECCIONA OTROS SETS PARA CREAR TU PROPIA CIUDAD HOT WHEELS!  
COLLECTIONNEZ D'AUTRES COFFRETS DE JEU POUR CONSTRUIRE VOTRE  
PROPRE VILLE HOT WHEELS! • COLECCIONE OUTROS CONJUNTOS PARA  
MONTAR A SUA CIDADE HOT WHEELS**

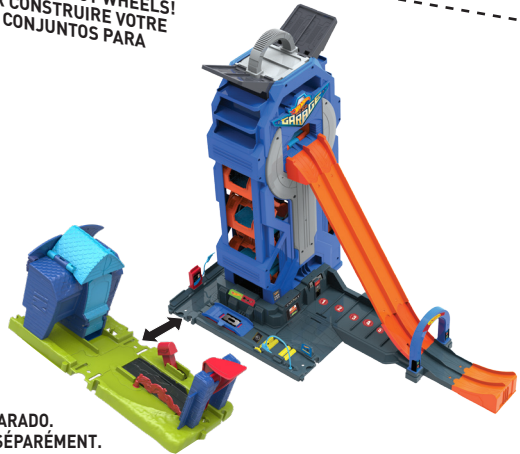
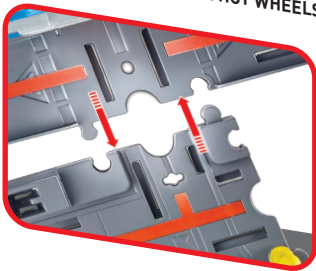

**OTHER HOT WHEELS® TRACKS AND SETS SOLD SEPARATELY.  
LOS OTROS SETS Y PISTAS HOT WHEELS SE VENDEN POR SEPARADO.  
AUTRES PISTES ET COFFRETS DE JEU HOT WHEELS VENDUS SÉPARÉMENT.  
OUTROS CONJUNTOS E PISTAS HOT WHEELS VENDIDOS SEPARADAMENTE.**

©2018 Mattel, Mattel, Inc., 636 Girard Avenue, East Aurora, NY 14052, U.S.A. Consumer Services 1-800-524-8697. Mattel Canada Inc., Mississauga, Ontario L5R 3W2. You may call us free at / Composez sans frais le 1-800-524-8697. Mattel Australia Pty., Ltd., Richmond, Victoria, 3121. Consumer Advisory Service - 1300 135 312. Mattel East Asia Ltd., Room 503-09, North Tower, World Finance Centre, Harbour City, Tsimshatsui, HK, China. Tel.: (852) 3185-6500. Diiimport & Diedarkan Oleh: Mattel Southeast Asia Pte. Ltd., No 19-1, Tower 3 Avenue 7, Bangsar South City, No 8, Jalan Kerinchi, 59200 Kuala Lumpur, Malaysia. Tel: 03-33419052. Mattel U.K. Ltd., Vanwall Business Park, Maidenhead SL6 4UB. Importado y distribuido por Mattel de México, S.A. de C.V., Miguel de Cervantes Saavedra No. 193, Pisos 10 y 11, Col. Granada, Delegación Miguel Hidalgo, C.P. 11520, México, Ciudad de México. R.F.C. MME-920701-NB3. Tels.: 59-05-51-00 Ext. 5206 ó 01-800-463-59-89. Mattel Chile, S.A., Avenida Américo Vespucio 501-B, Quilicura, Santiago, Tel.: 1230-020-6213. Servicio al consumidor Venezuela: Tel.: 0-800-100-9123. Mattel Argentina, S.A., Curupayti 1186, (1607) - Villa Adelina, Buenos Aires. Tel.: 0800-666-3373. Mattel Colombia, S.A., Calle 123#7-07 P.5, Bogotá. Tel.: 01800-710-2069. Mattel Perú, S.A., Av. Juan de Arona # 151, Centro Empresarial Juan de Arona, Torre C, Piso 7, Oficina 704, San Isidro, Lima 27, Perú. RUC: 20425853865. Reg. Importador: 02350-12-JUE-DIGESA. Tel.: 0800-54744. E-mail Latinoamérica: ServicioClientes@Mattel.com. Distribuido por: Mattel do Brasil Ltda.- CNPJ: 54.558.002/0001-20 - Rua Verbo Divino, 1488 - 2º. Andar - 04719-904 - Chácara Santo Antônio - São Paulo - SP - Brasil. Serviço de Atendimento ao Consumidor: fone 0800-550780. E-mail: sac@mattel.com. Mattel France, Parc de la Cerisaie, 1/3/5 allée des Fleurs, 94263 Fresnes Cedex. N° Cristal 0969 36 99 99 (Numéro non surtaxé) ou www.lesjouetsmattel.fr. Mattel España, S.A., Aribau 200, 08036 Barcelona, cservice.spain@mattel.com. Tel: 902203010. <http://www.service.mattel.com/es>. Mattel Portugal Lda. Edifício Amoreiras Square, Rua Carlos Alberto da Mota Pinto nº 17 - 3º A, 1070-313 Lisboa. Tel. Número Verde: 800 10 10 71 - consumidor@mattel.com. Mattel South Africa (PTY) LTD, Office 102 I3, 30 Melrose Boulevard, Johannesburg 2196.