

HOT WHEELS



INSTRUCTIONS



 **WARNING:**
CHOKING HAZARD - Small parts.
Not for children under 3 years.

AGES

5-8

service.mattel.com

HOTWHEELS.COM



FTB69-0970-G1
1101675439-DOM

COLORS AND DECORATIONS MAY VARY.
INCLUDES 2 VEHICLES. ADDITIONAL VEHICLES SOLD SEPARATELY.

ADULT ASSEMBLY REQUIRED

PLEASE KEEP THESE INSTRUCTIONS FOR FUTURE
REFERENCE AS THEY CONTAIN IMPORTANT INFORMATION.

CONTENTS

WHAT'S INCLUDED

3

ASSEMBLY

4

HOW TO PLAY

17

MORE WAYS TO PLAY

23

PERFORMANCE TIPS

24

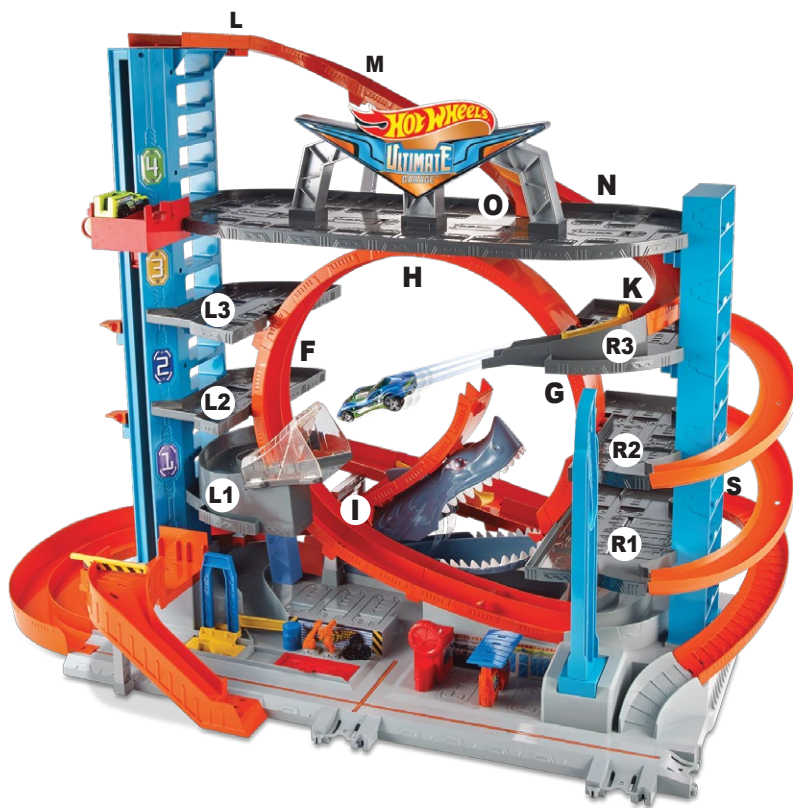

PARENTS: For more tips, check out HW Ultimate Garage™ assembly video on the [Hot Wheels® YouTube Channel](#) or www.hotwheels.com

YouTube

WHAT'S INCLUDED

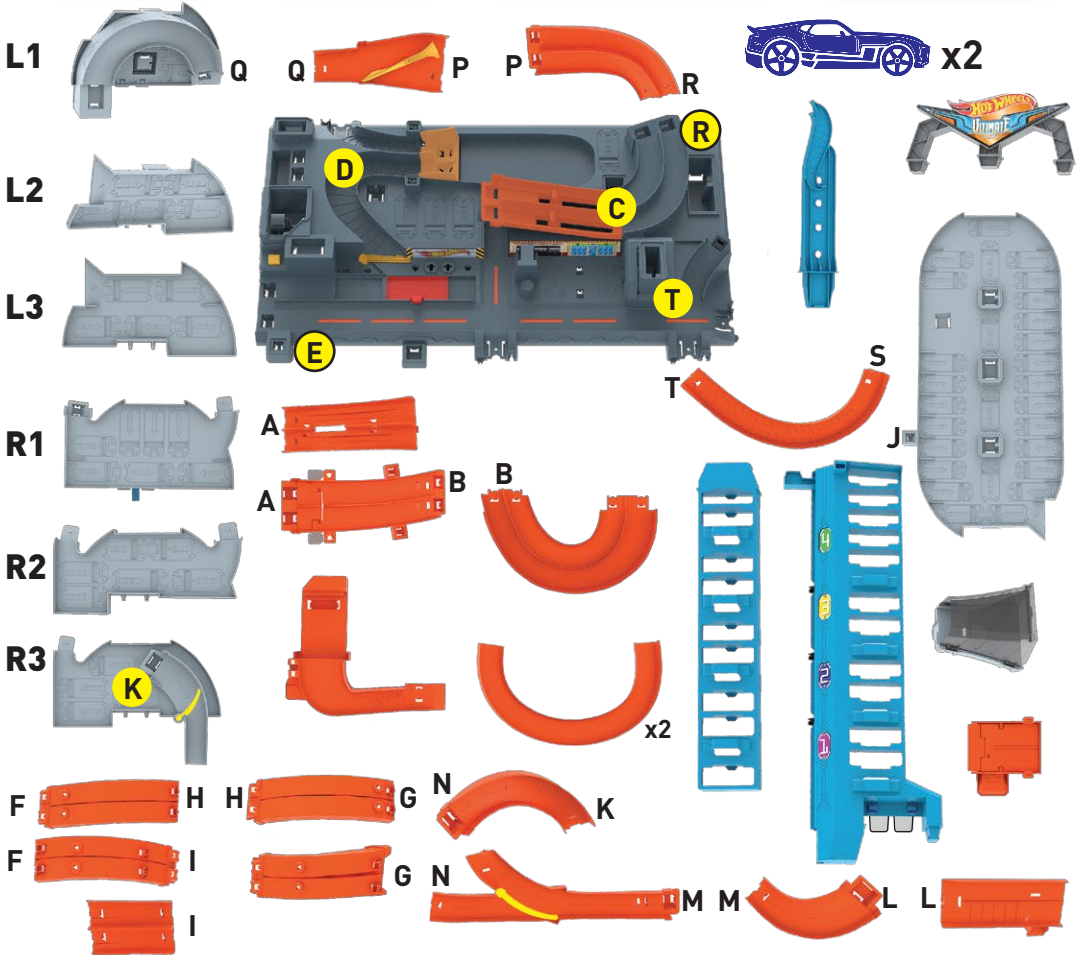
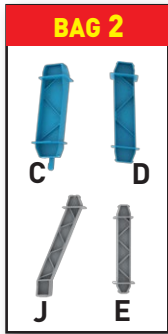

ASSEMBLY

1

BAG 1

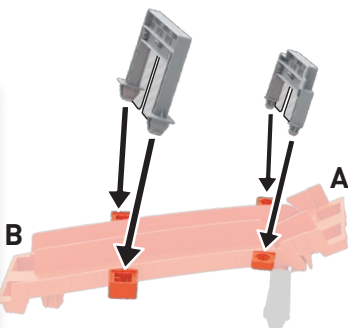

2

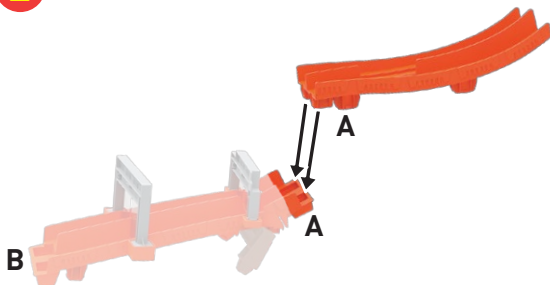

TIP: OPEN EACH BAG FOLLOWING THE ASSEMBLY STEPS.

3

BAG 4

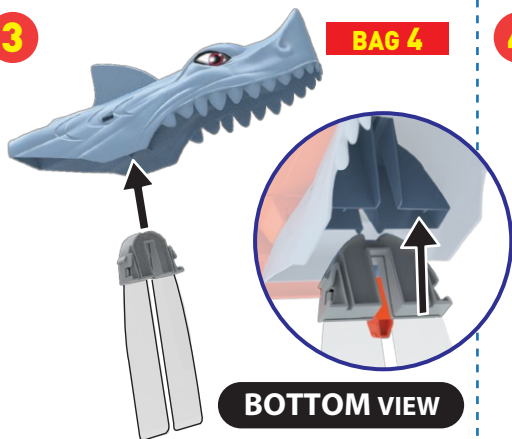

4

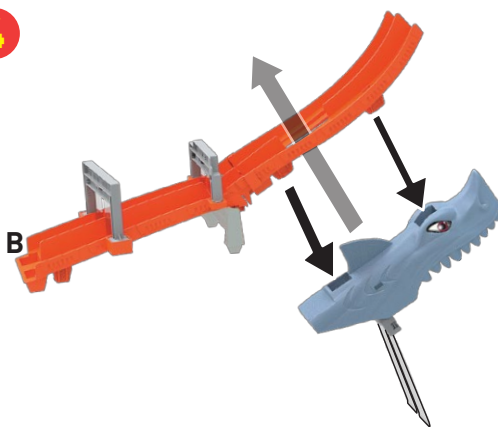

5

BAG 5

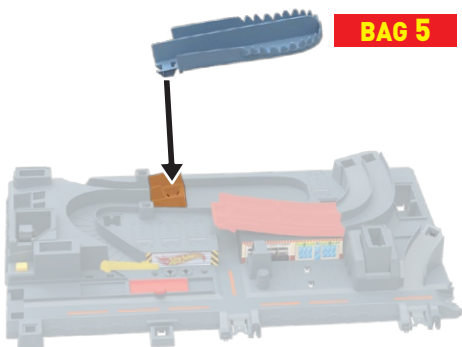

6

! IMPORTANT: MOVE FLAPS INWARD.

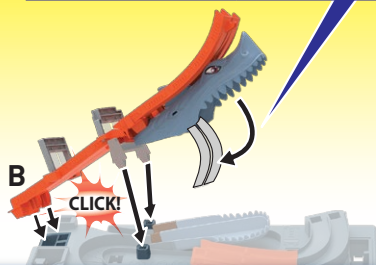
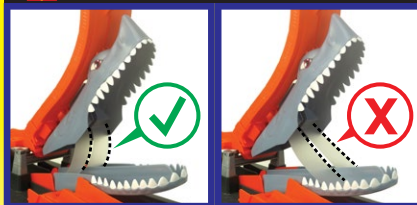

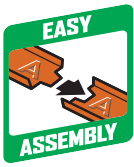

Refer to **LETTERS** shown for easy assembly.

7

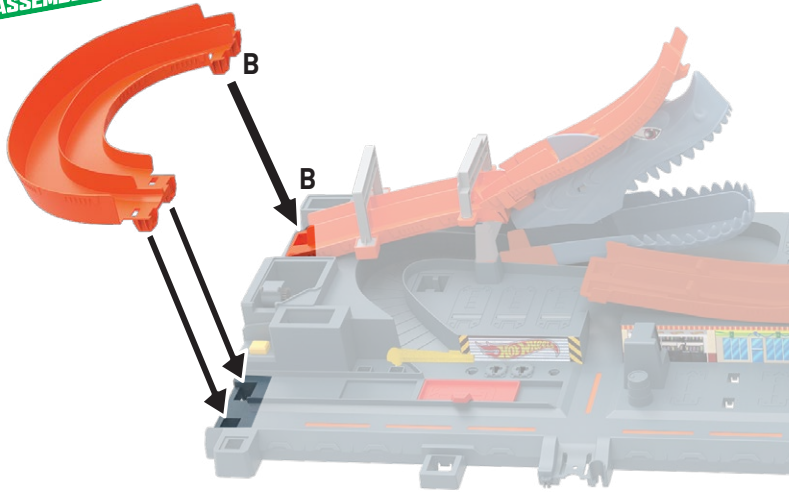

8

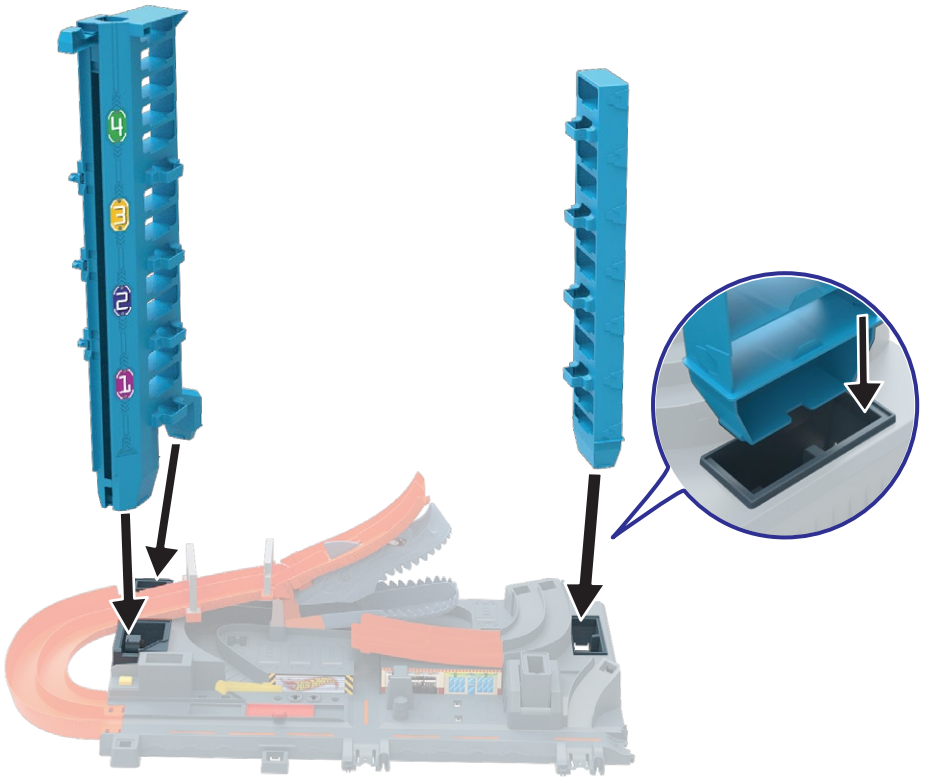

BAG 2

9

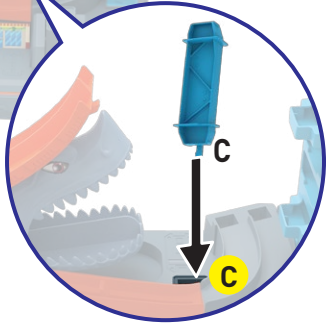
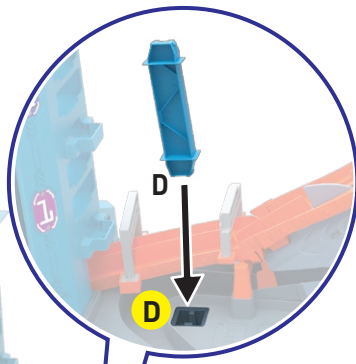
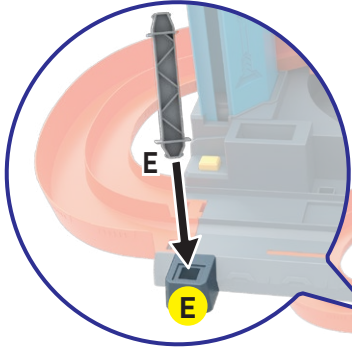
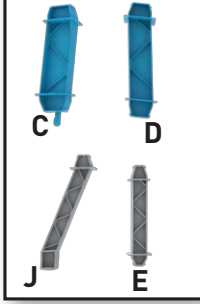

10

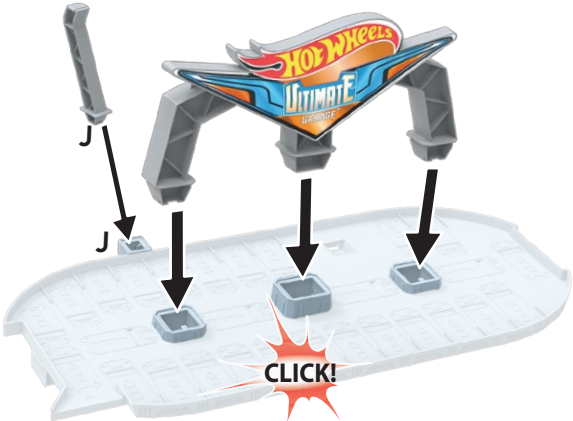

11

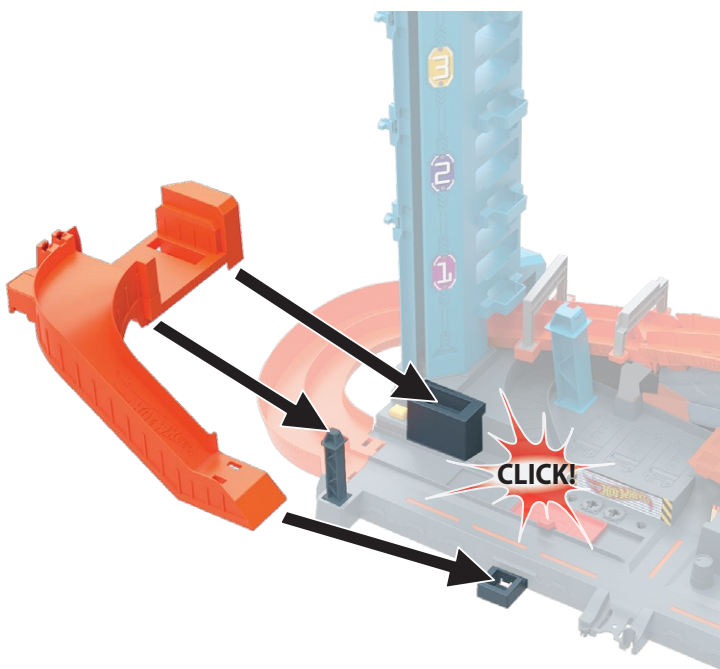

12

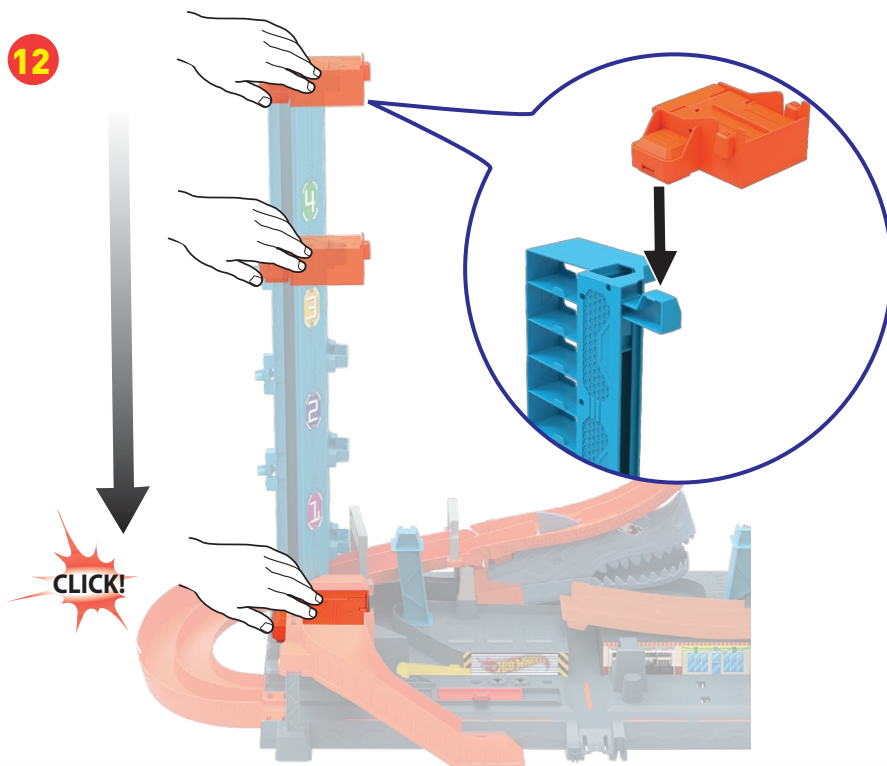

13

LEVEL 1

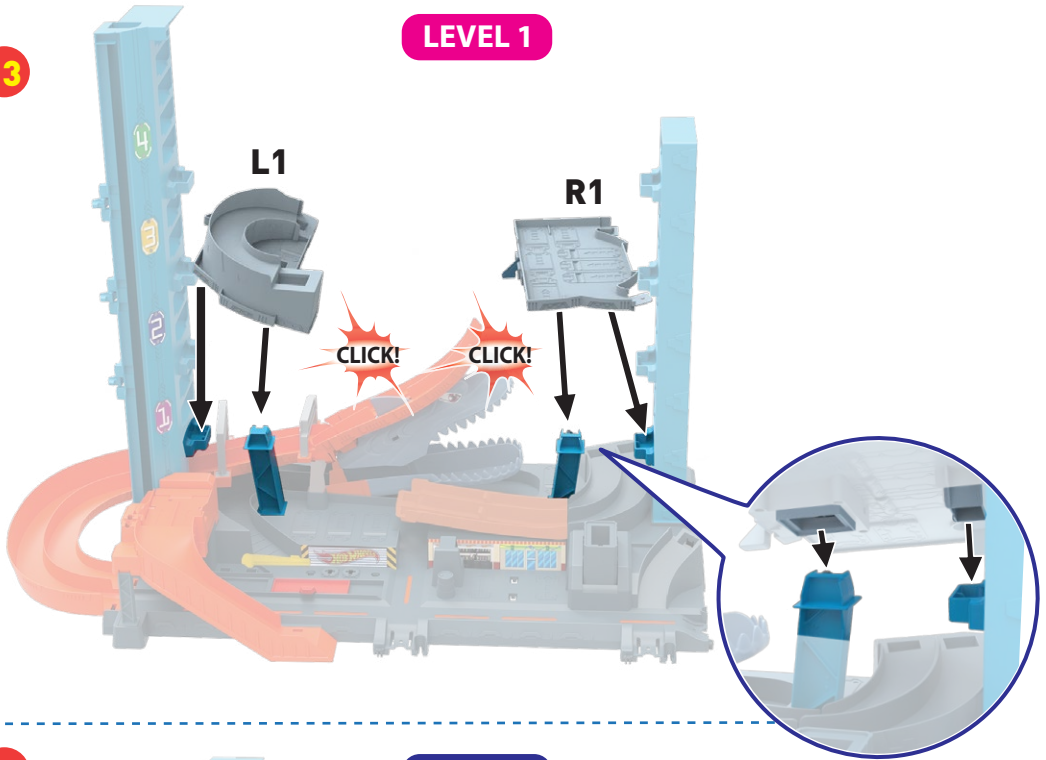

14

LEVEL 2

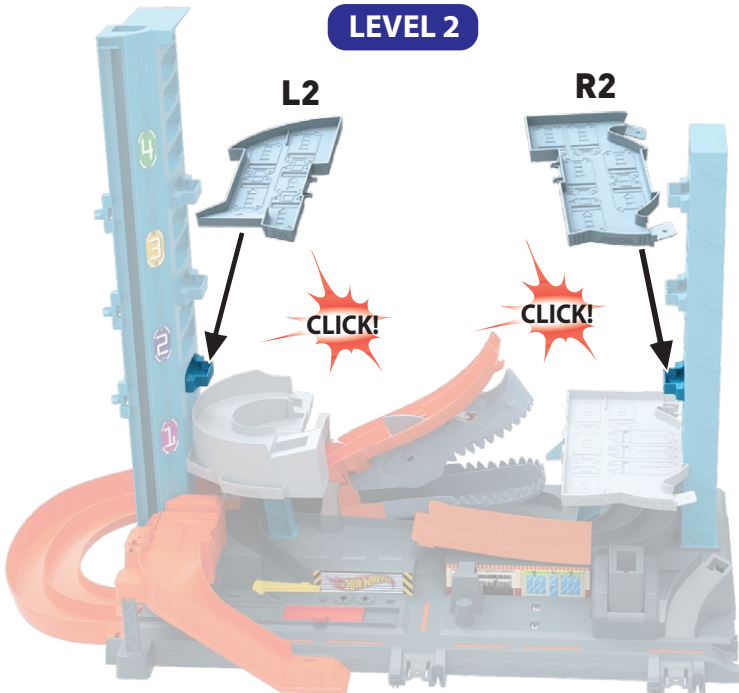

15

LEVEL 3

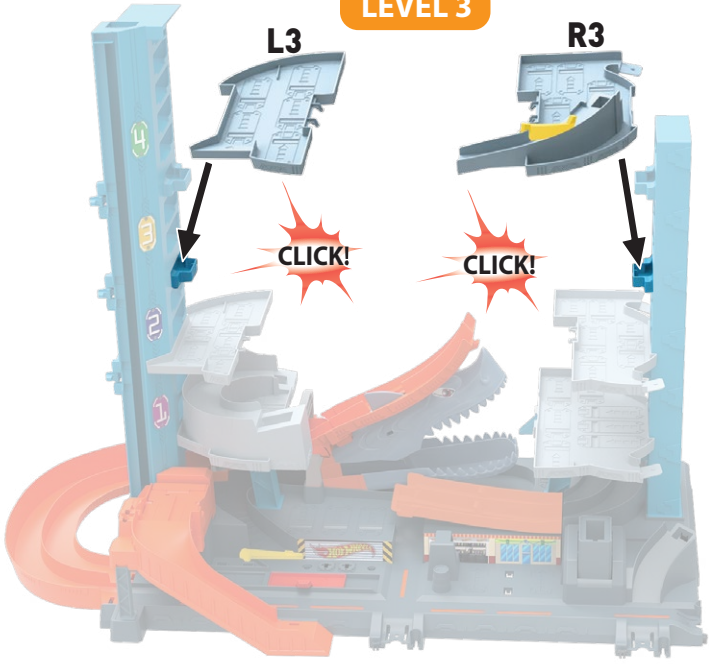

16



Refer to **LETTERS** shown for easy assembly.

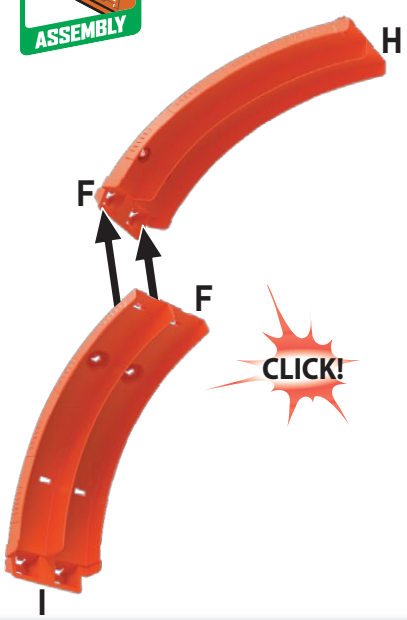

17

BACK VIEW

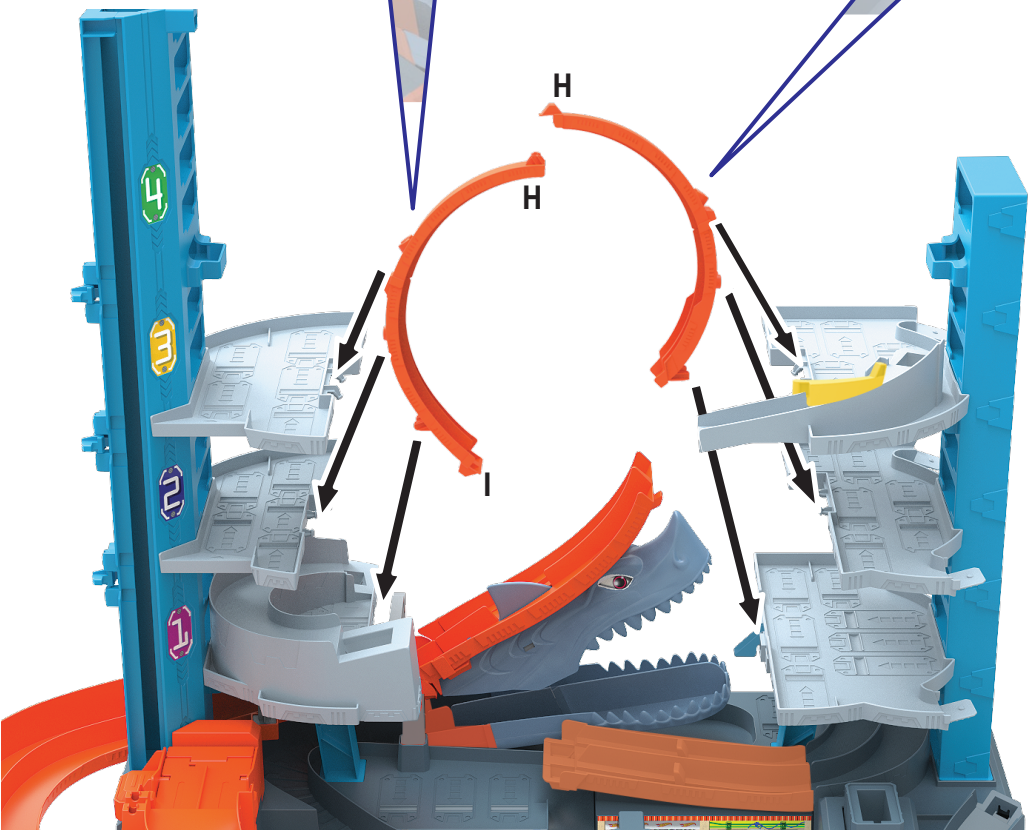
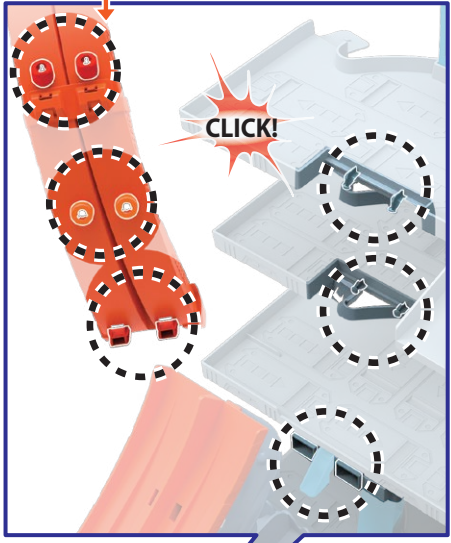
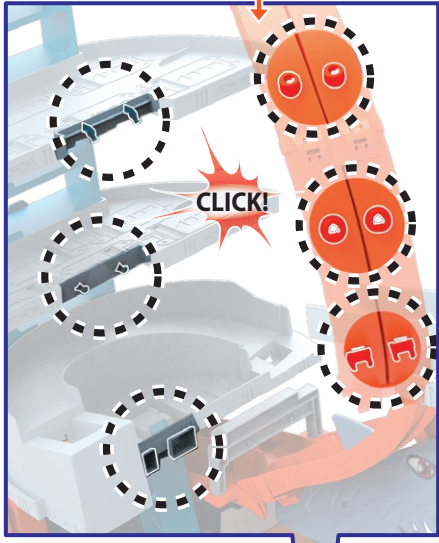

18

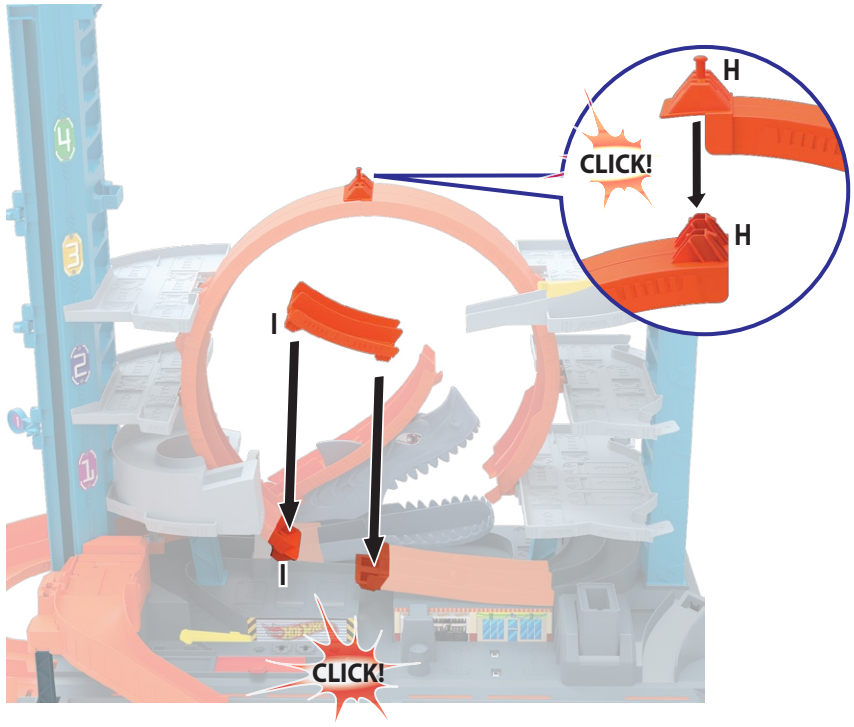

19

BACK VIEW

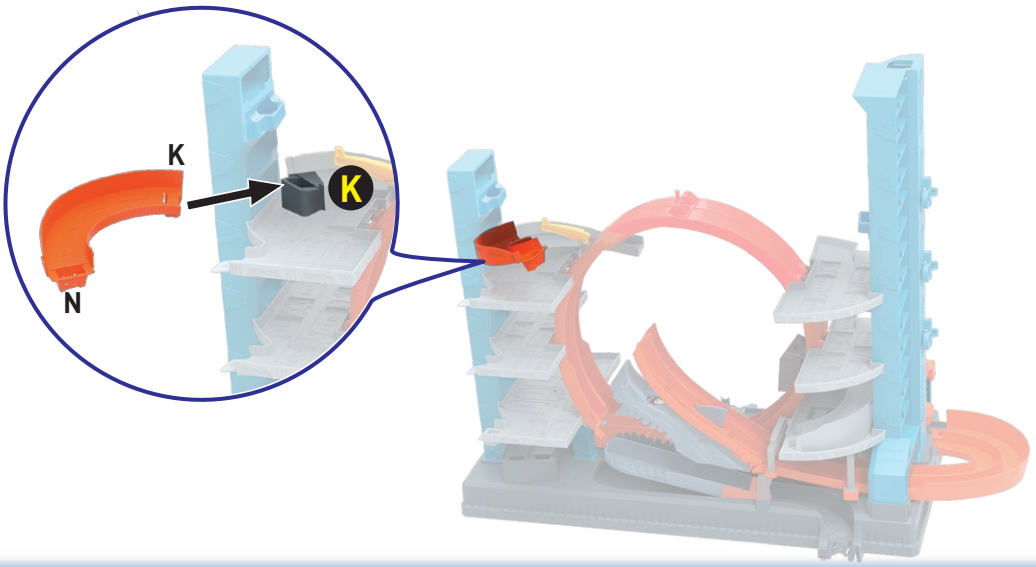

20

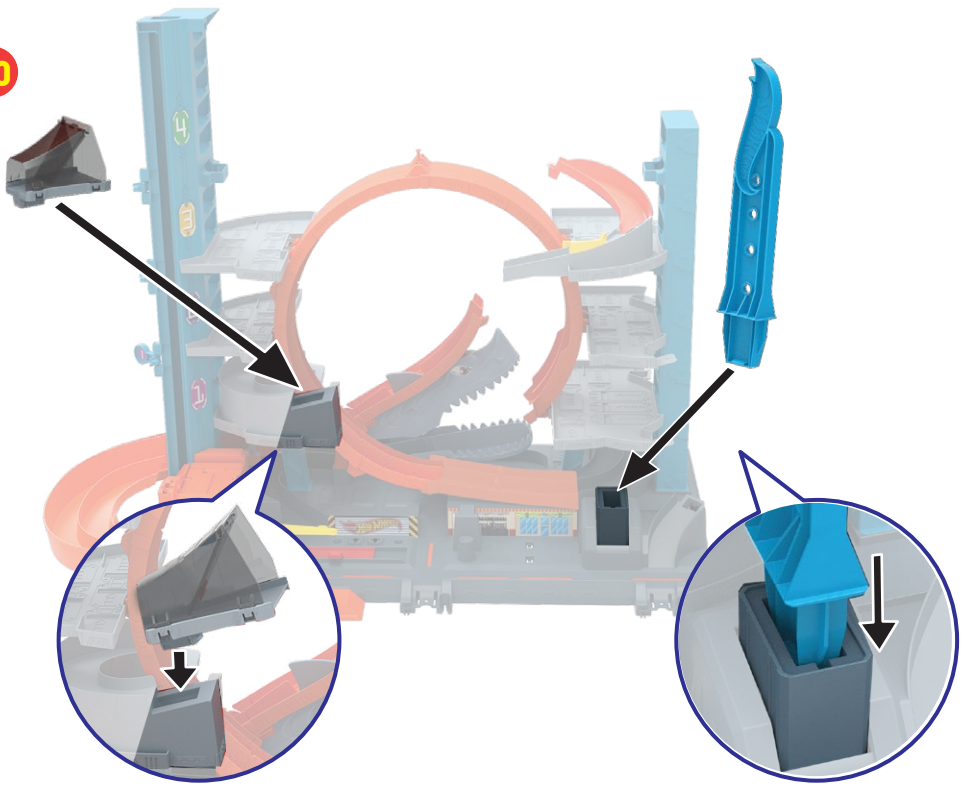

21

LEVEL 4

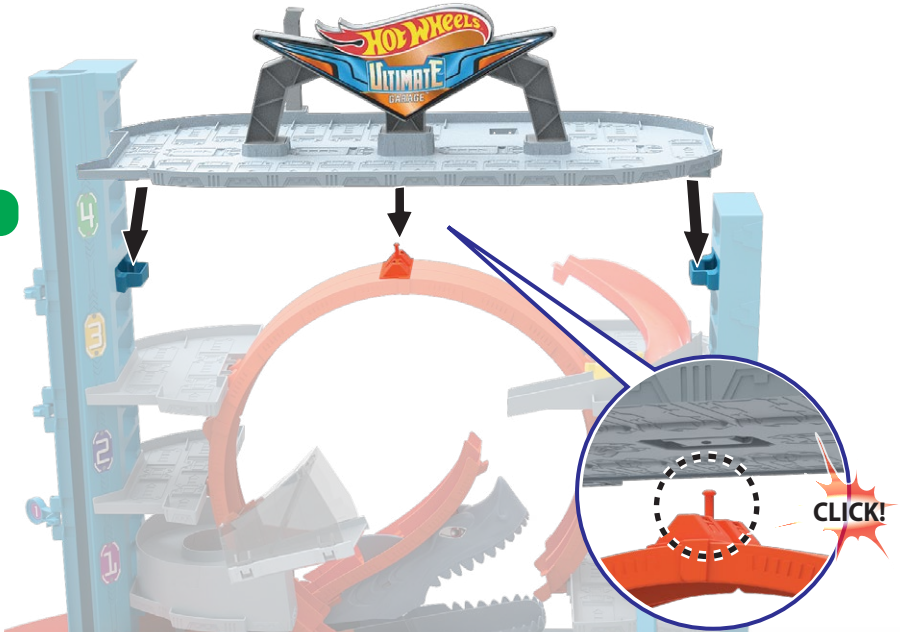

22

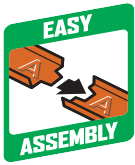

Refer to **LETTERS** shown for easy assembly.

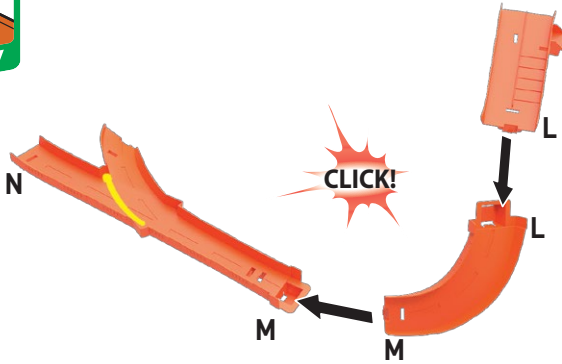

23

BACK VIEW

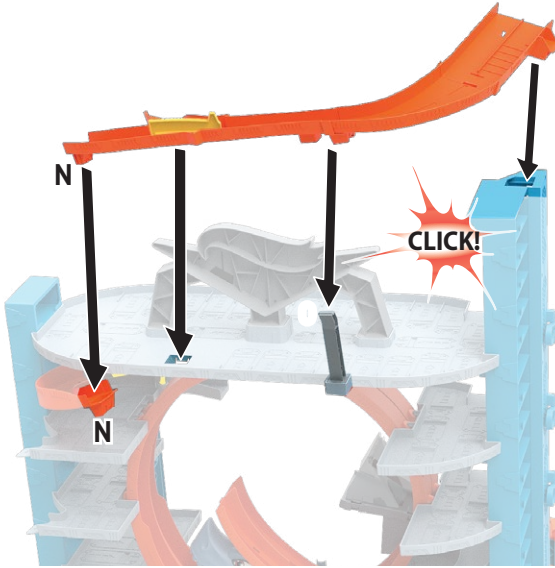

24

BACK VIEW

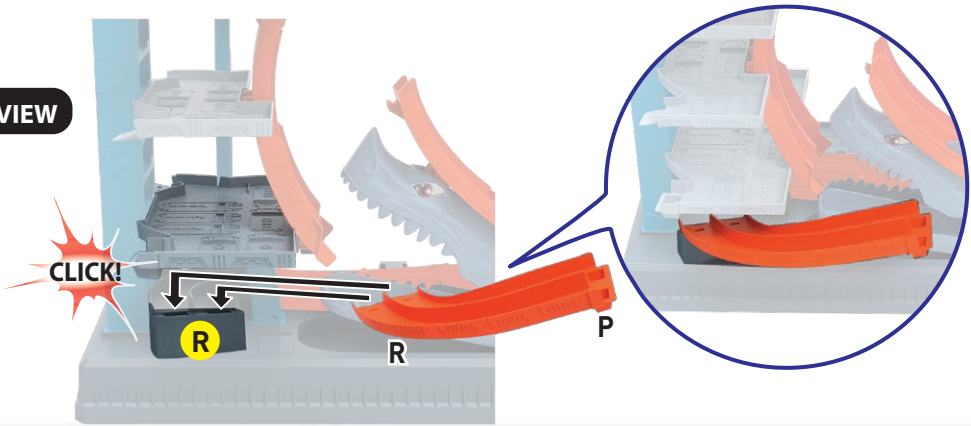

25

BACK VIEW

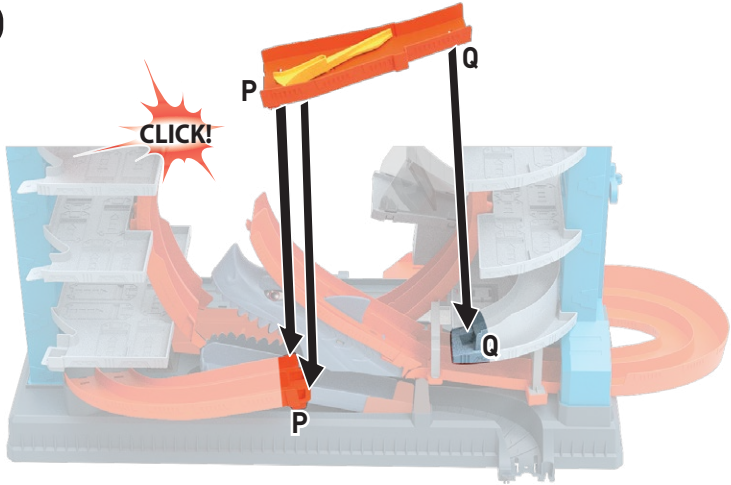

26

SIDE VIEW

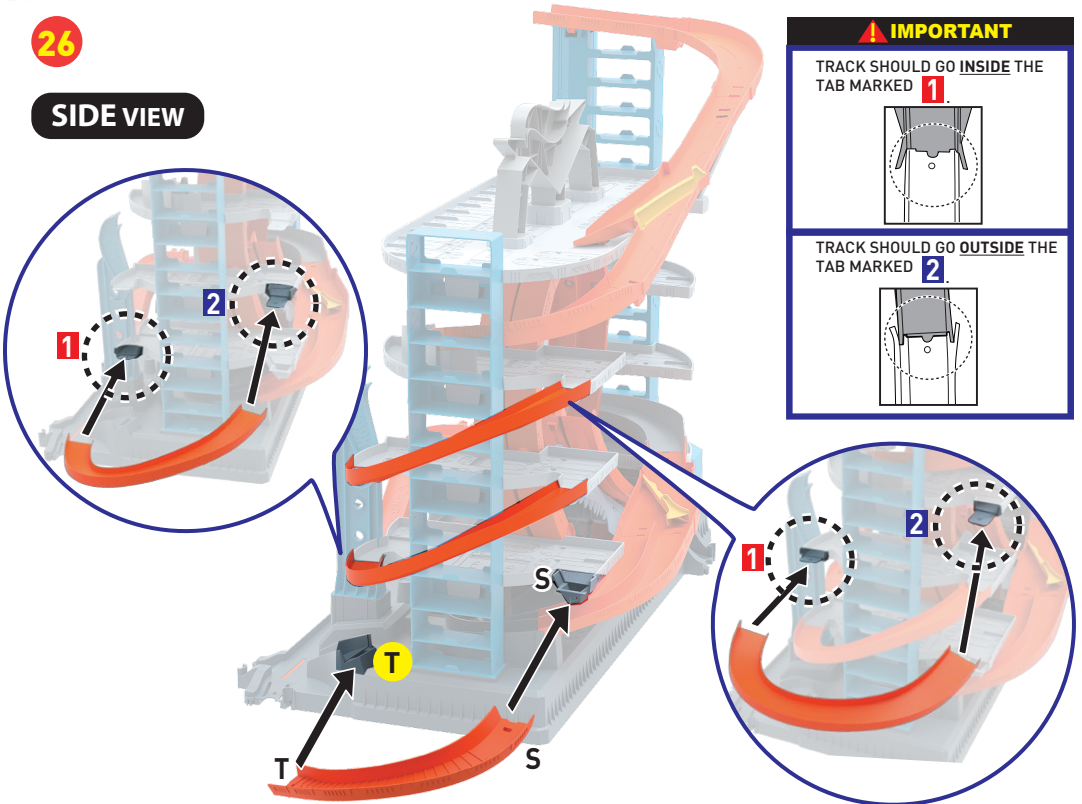

27

BAG 3

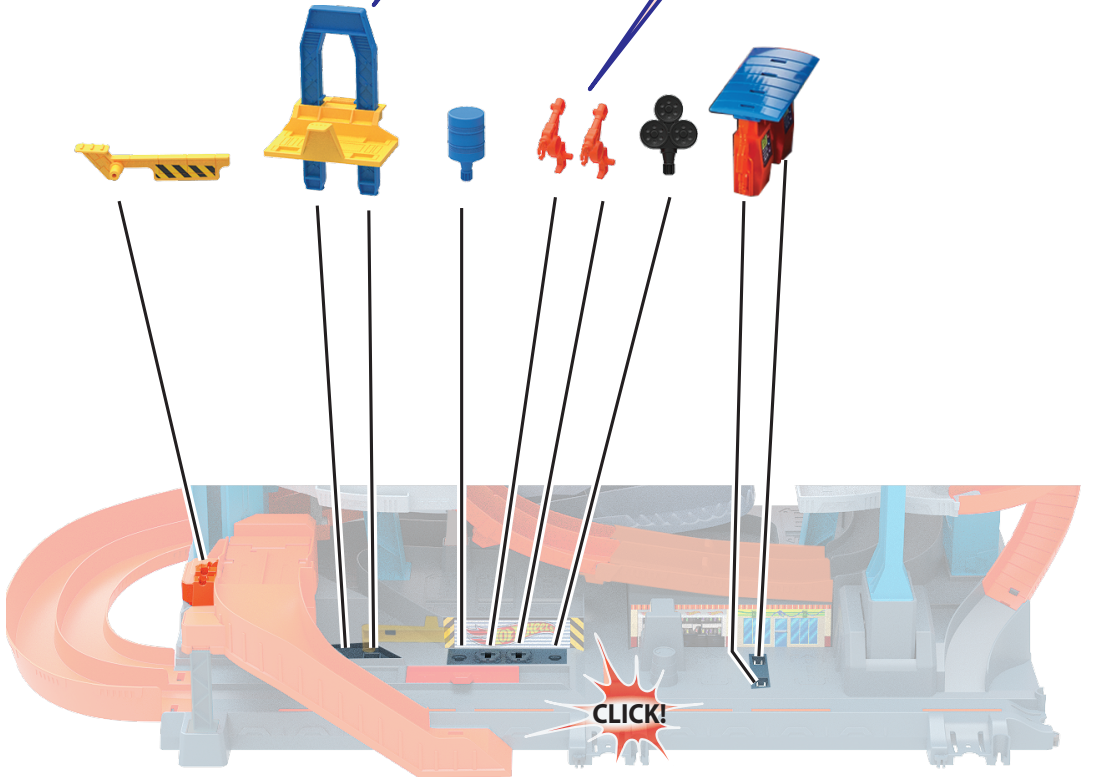
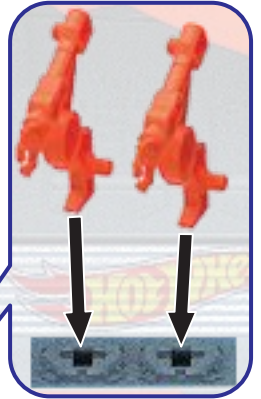
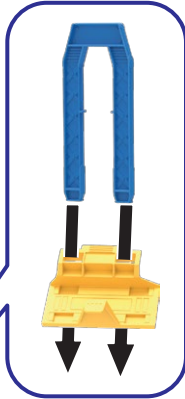

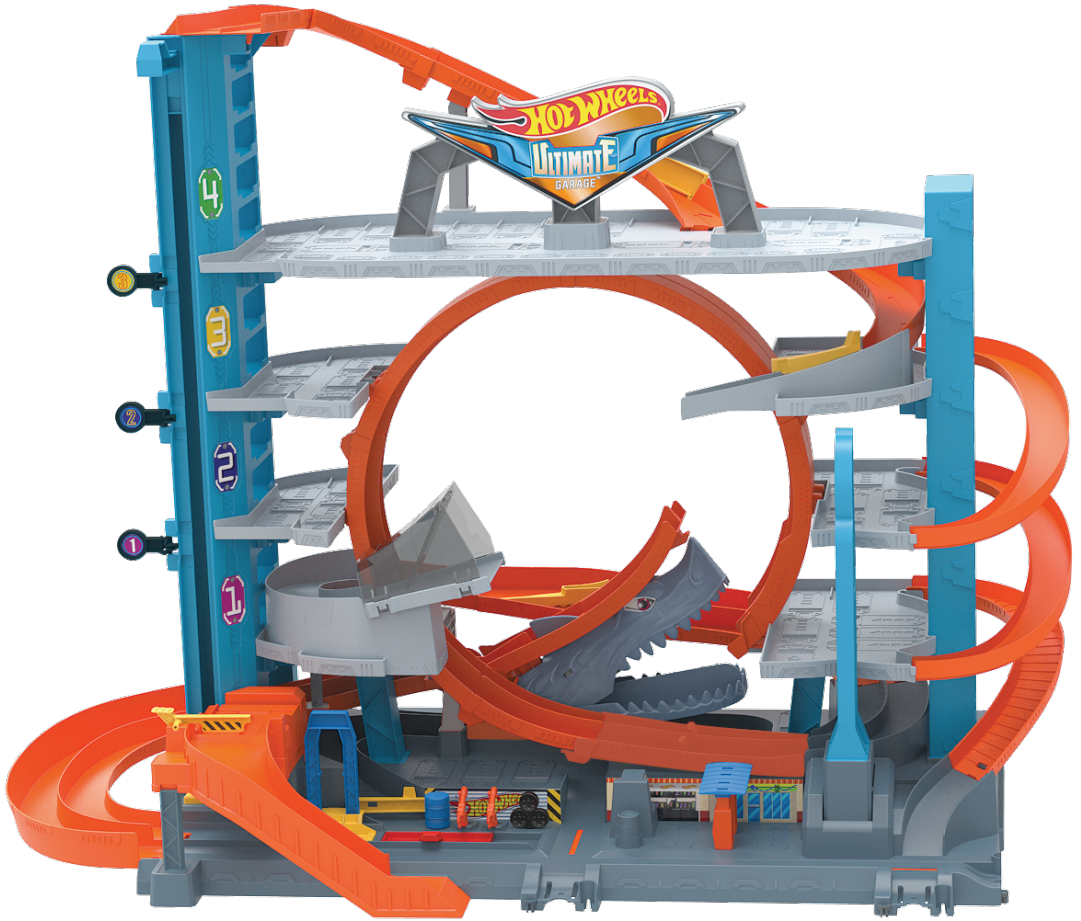

HOW TO PLAY

RACING

- 1 MOVE DIVERTERS TO THE SIDE SO CARS CAN RACE DOWN THE TRACK. THEN CLOSE SHARK'S MOUTH.

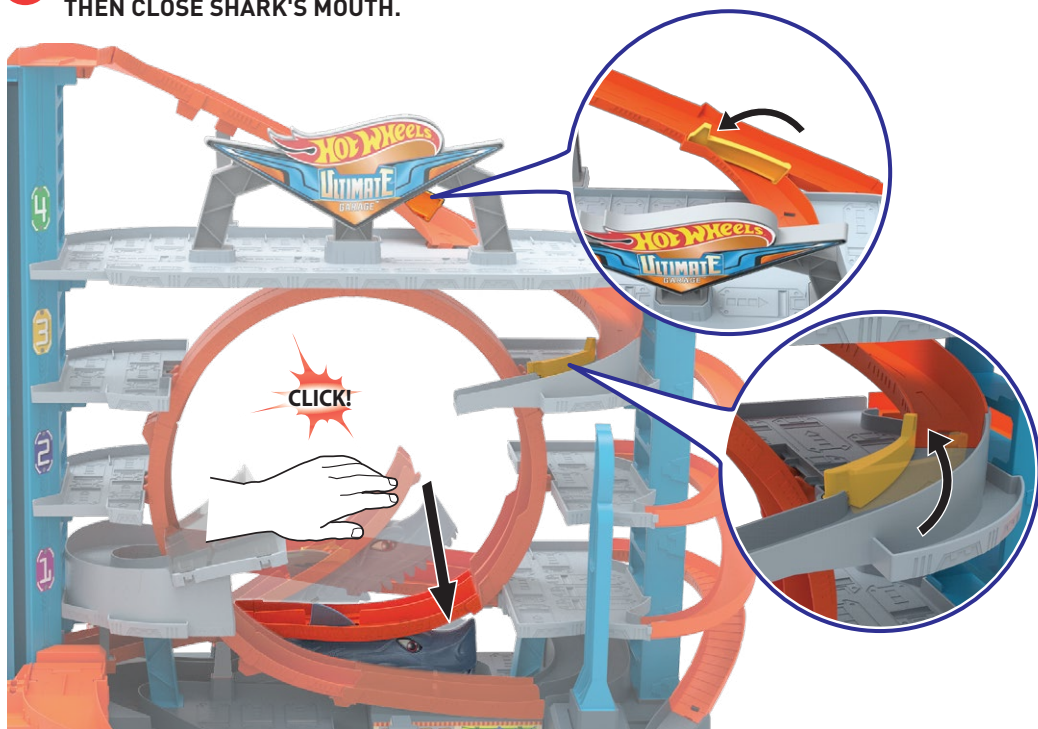

- 2 DRIVE 2 CARS UP TO CAR LIFT.

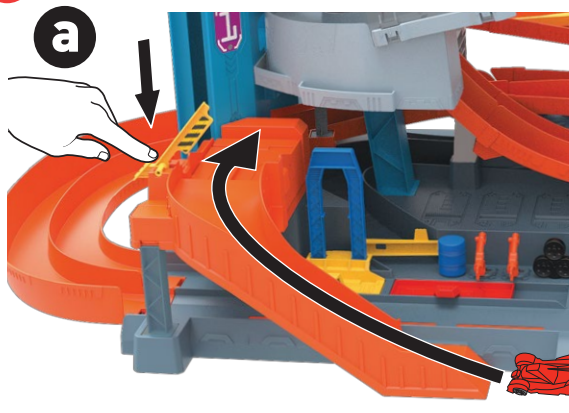

3 **PRESS BUTTON** TO ACTIVATE CAR LIFT. CARS RACE DOWN THE ROOF TO ANOTHER LAUNCHING PLATFORM.

PRESS HERE!

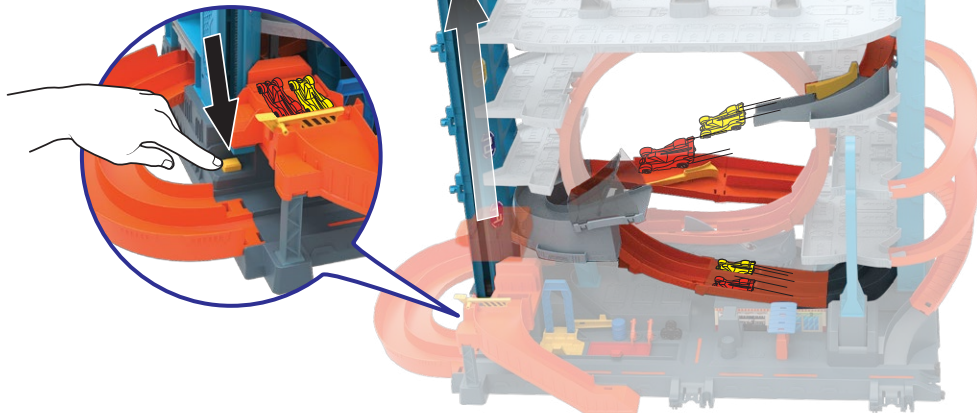

4a **PULL HANDLE** TO LAUNCH AND SPEED THROUGH THE LOOPS SAFELY...

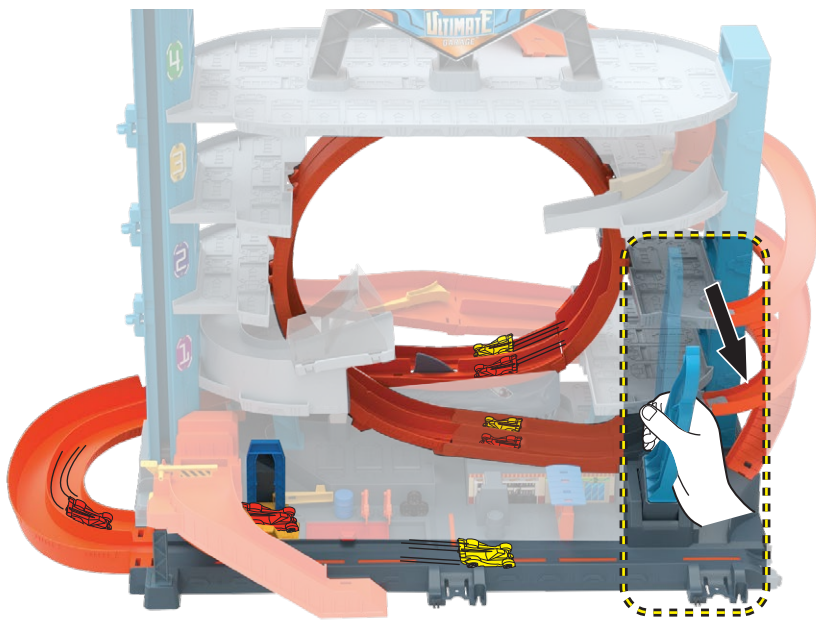

4b ...OR IF YOU'RE UNLUCKY GET CHOMPED BY THE SHARK AND TRY AGAIN!

BACK VIEW

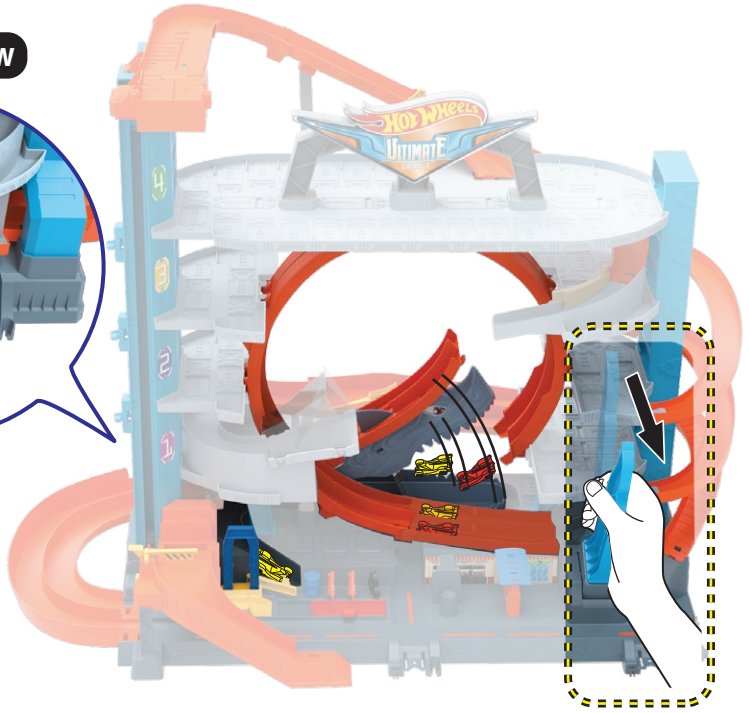
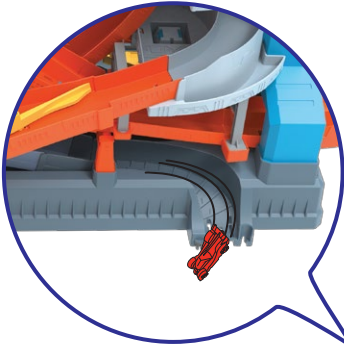

5 CHECK AND TUNE-UP YOUR CAR AT SERVICE STATION.

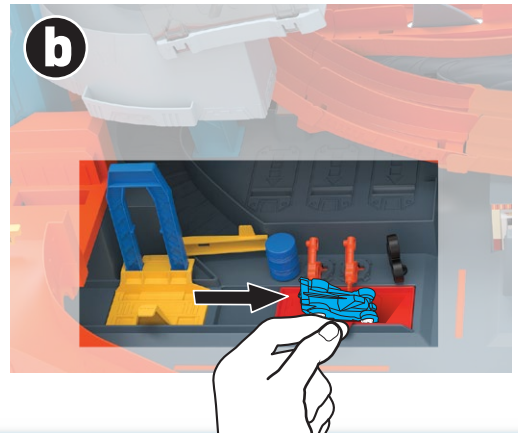
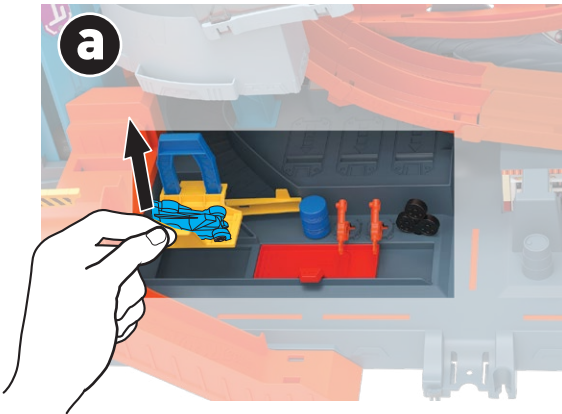

PARKING

- 1 MOVE DIVERTER TO DRIVE ALONG THE TRACKS AND FIND A PARKING SPOT.

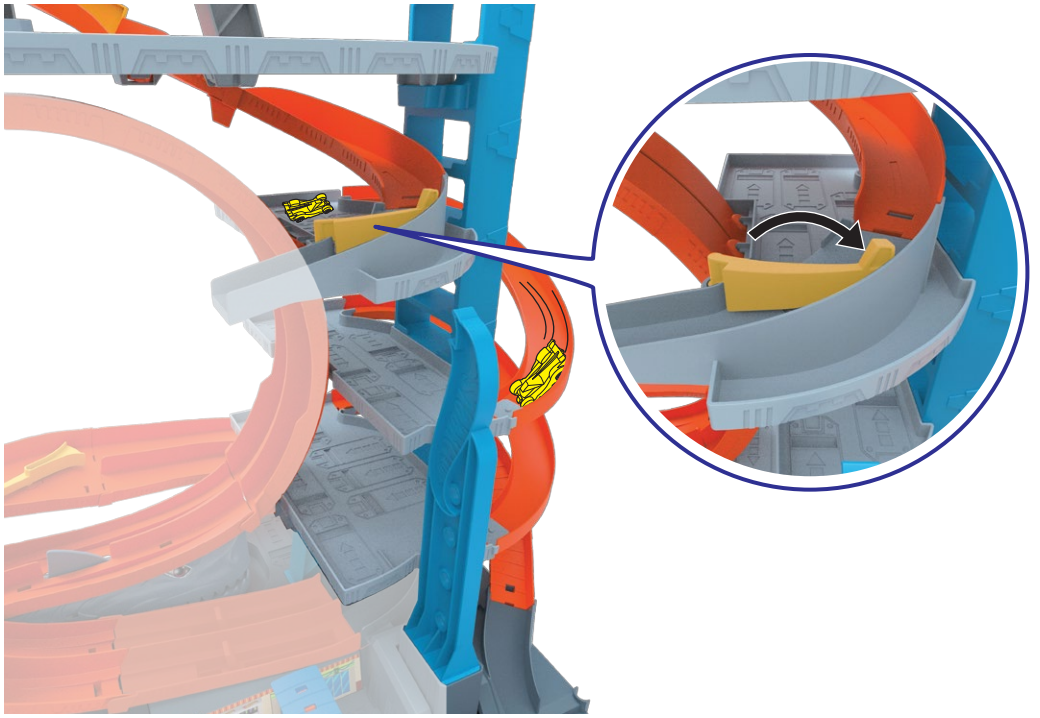

- 2 MOVE DIVERTER AND PARK YOUR CAR ON THE ROOF.

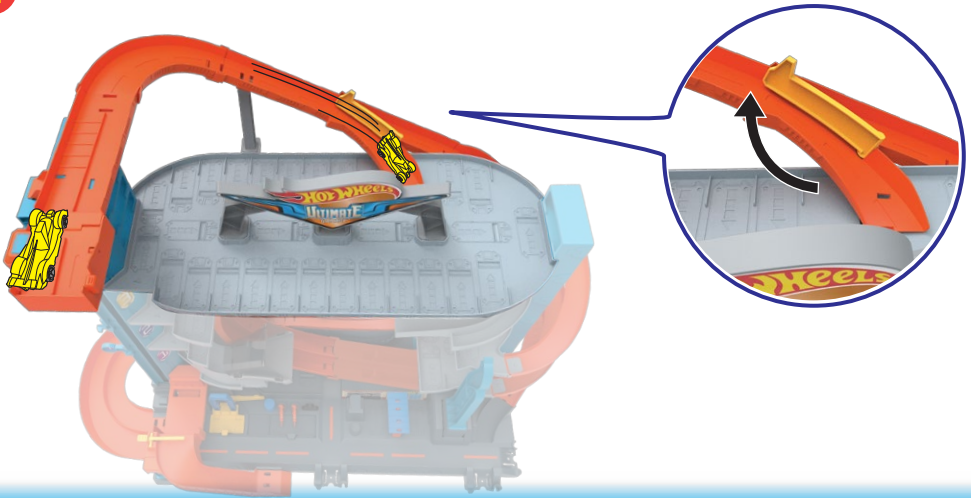

3a **FLIPTAB** TO STOP CAR LIFT AT THE DESIRED LEVEL.

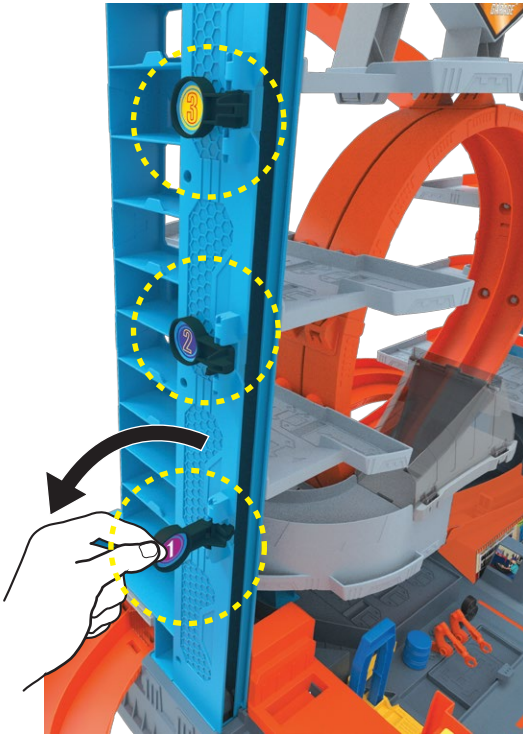

3b UNLOAD AND PARK YOUR CAR.

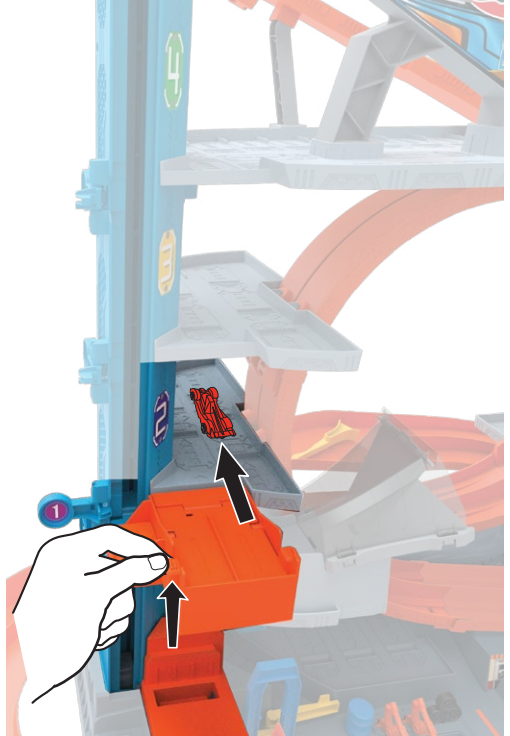

4 USE THE PARKING ZONES ON EACH LEVEL TO STORE OVER 90 OF YOUR HOT WHEELS® VEHICLES!

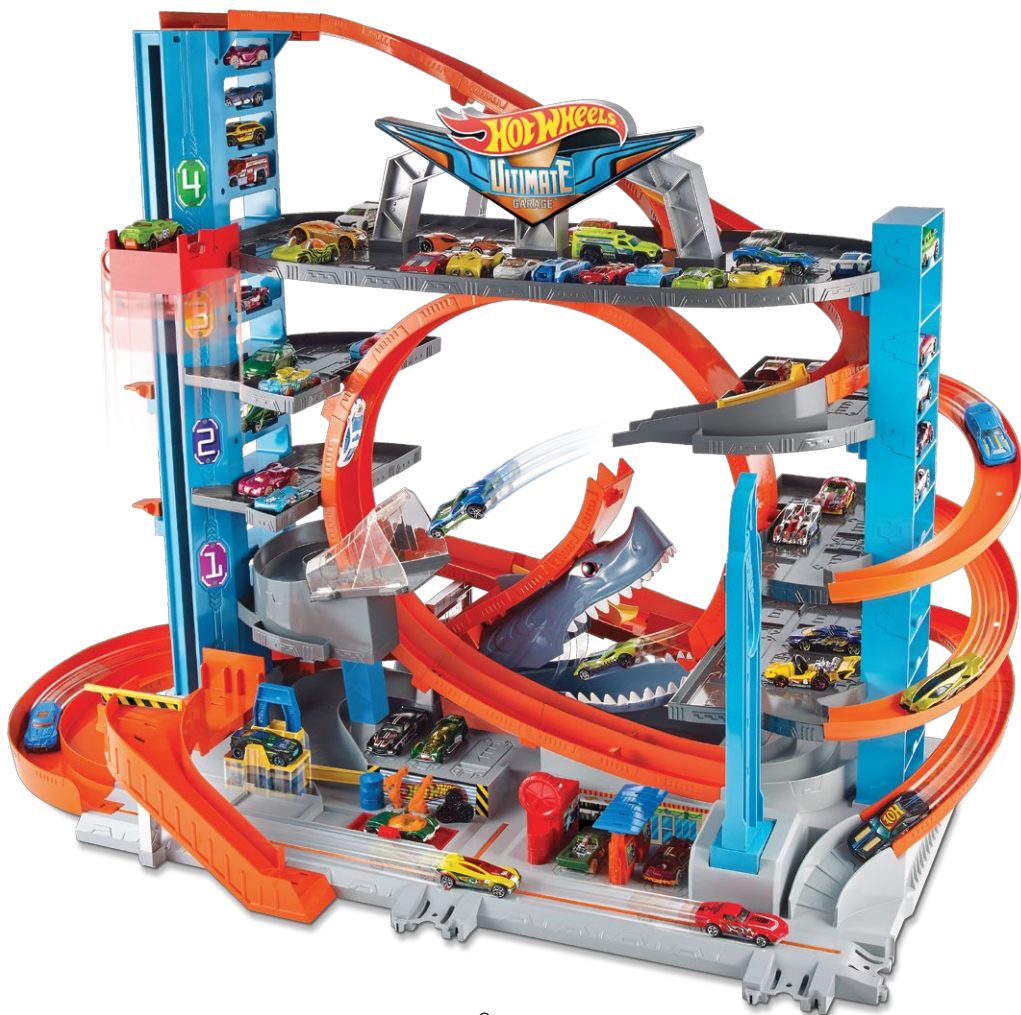

NOT FOR USE WITH SOME HOT WHEELS® VEHICLES.

MORE WAYS TO PLAY

CONNECT TO OTHER HOT WHEELS® SETS (SOLD SEPARATELY) TO BUILD YOUR UNIQUE HOT WHEELS™ CITY.

FRONT VIEW



BACK VIEW

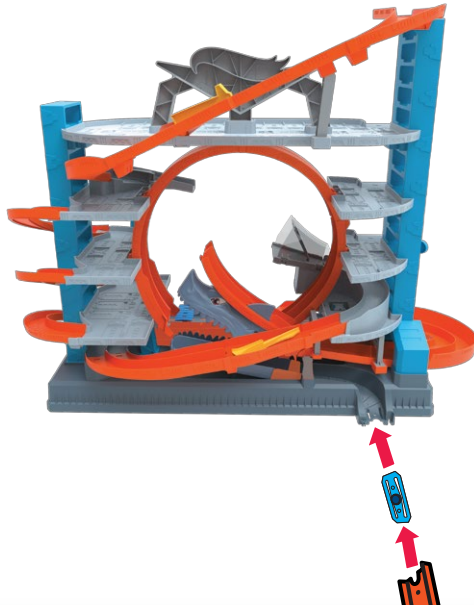

PERFORMANCE TIPS



Q. My vehicle keeps crashing on the track for no reason. What is the problem?

A. Clear all obstructions on the track. Adjust track side walls at each connection point and make sure they are assembled either inside or outside of the track tabs, as described in the assembly steps.

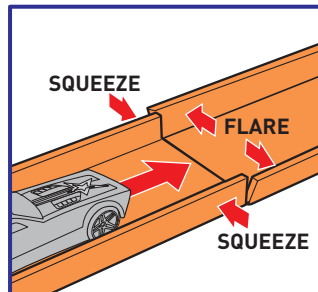

Q. My vehicle keeps slowing down by itself on the track. What is the problem?

A. Lint may collect around your vehicle's axles. This may cause the vehicle to run slowly. Use tweezers or a toothpick to remove lint.

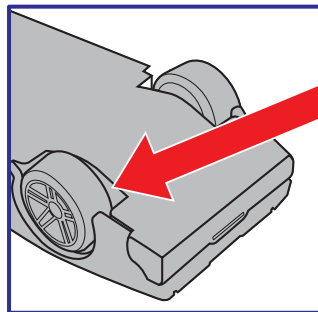

Q. My vehicle cannot get through the shark after being chomped. What is the problem?

A. Open the shark's mouth and make sure to move the flaps inward.

