

MEGA™
CONSTRUX

POKÉMON™



2

Venusaur vs. Beedrill Duel / Duel Florizarre vs. Dardagnan / Duelo Venusaur contra Beedrill
Duelo Venusaur vs. Beedrill / Duello Venusaur contro Beedrill / Bisafior vs. Bibor Duell
Pojedynek Venusaur vs. Beedrill / Venusaur versus Beedrill Duel / Венузавр против Бидрилла
Venusaur - Beedrill Duel / Beedrill ضد Venusaur مبارزة

FVK76



51

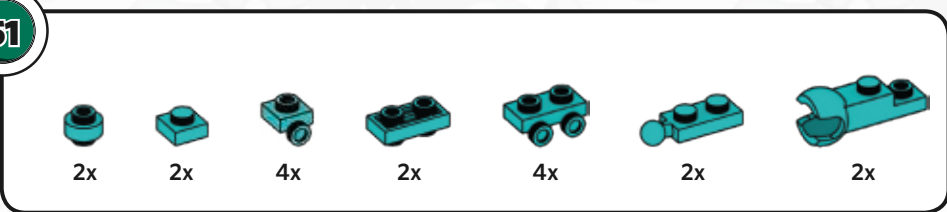

1

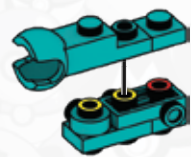

2

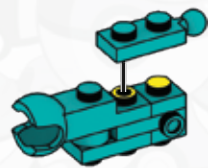

3



4

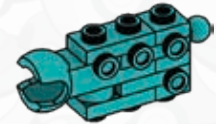

5

x2

52

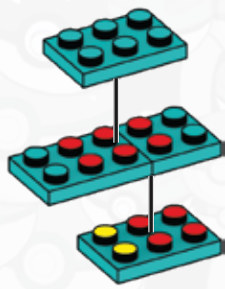
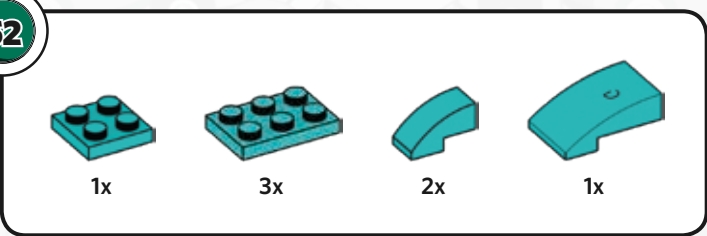

1



2



3



51

1

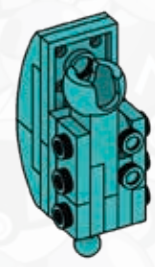

2





53

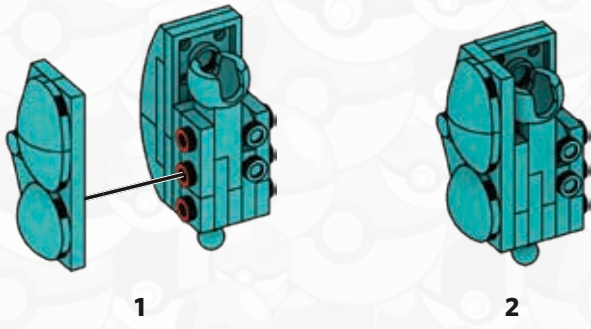
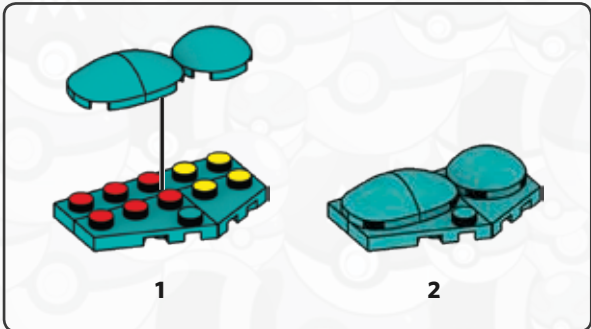
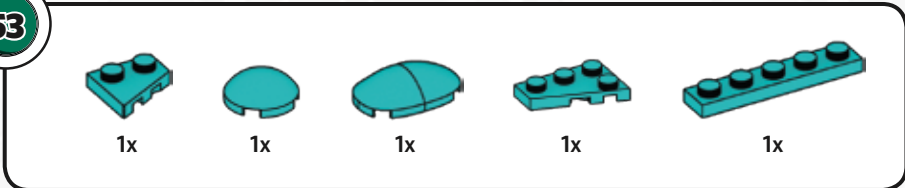

54

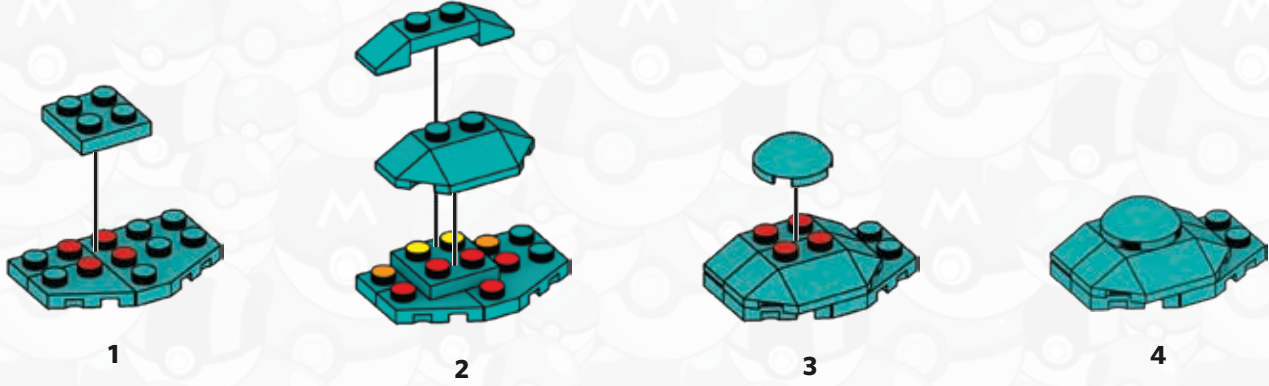
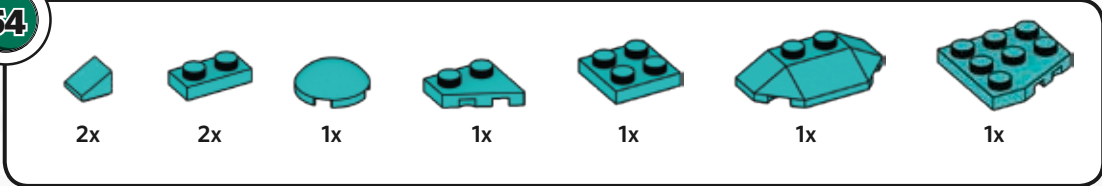



55

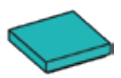

1x

53

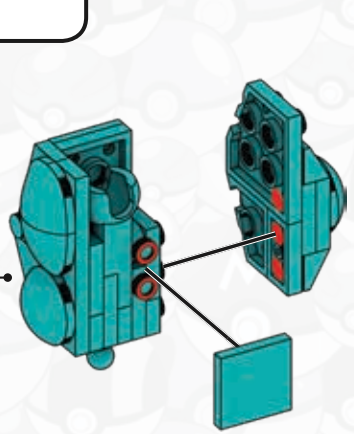

1

40

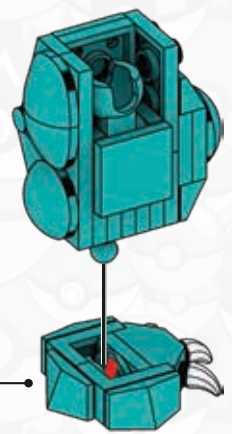

2

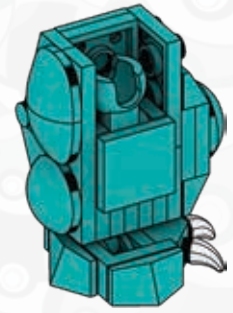

3

56



2x



2x



1x



1x

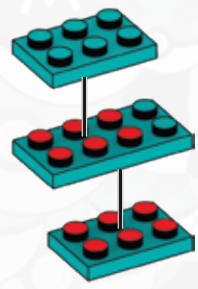

1



2



3

51



1

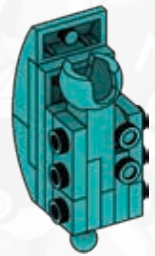
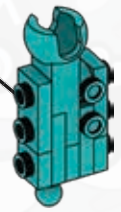

2





57

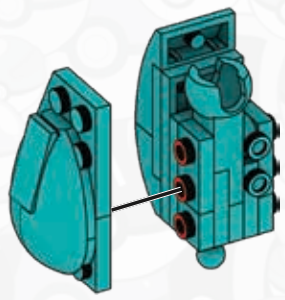
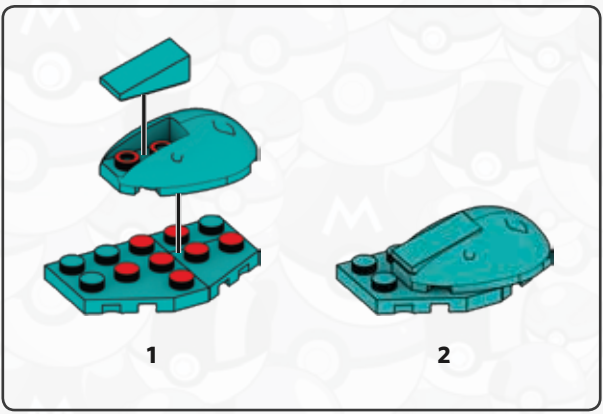
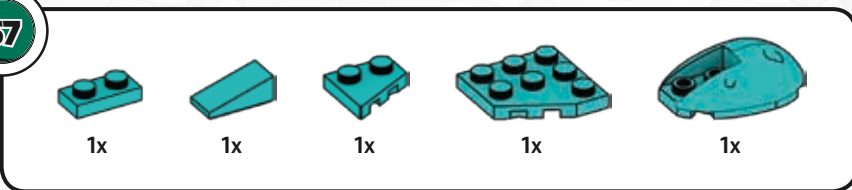

58

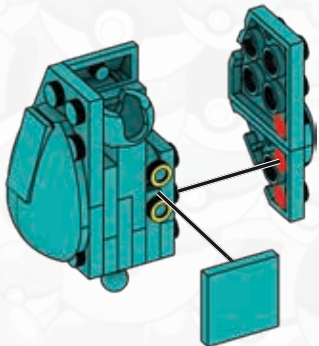
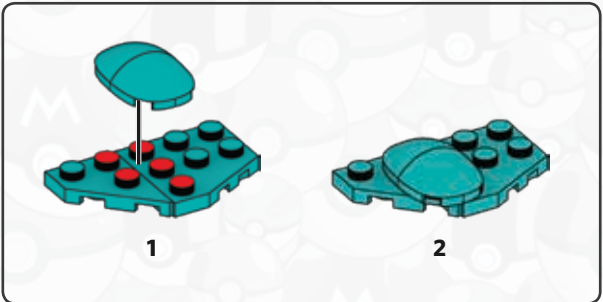
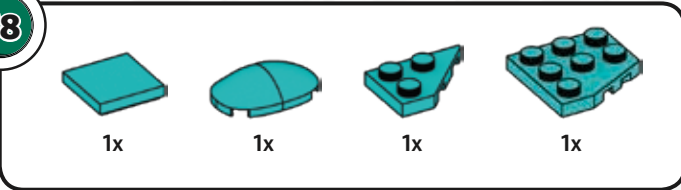

59

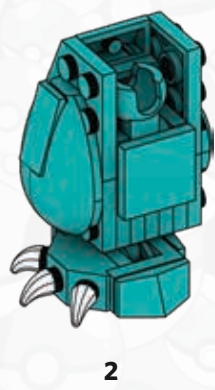
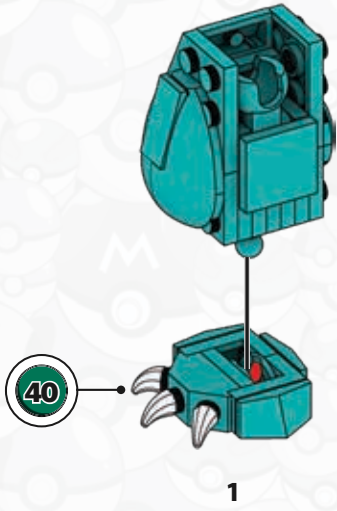



60

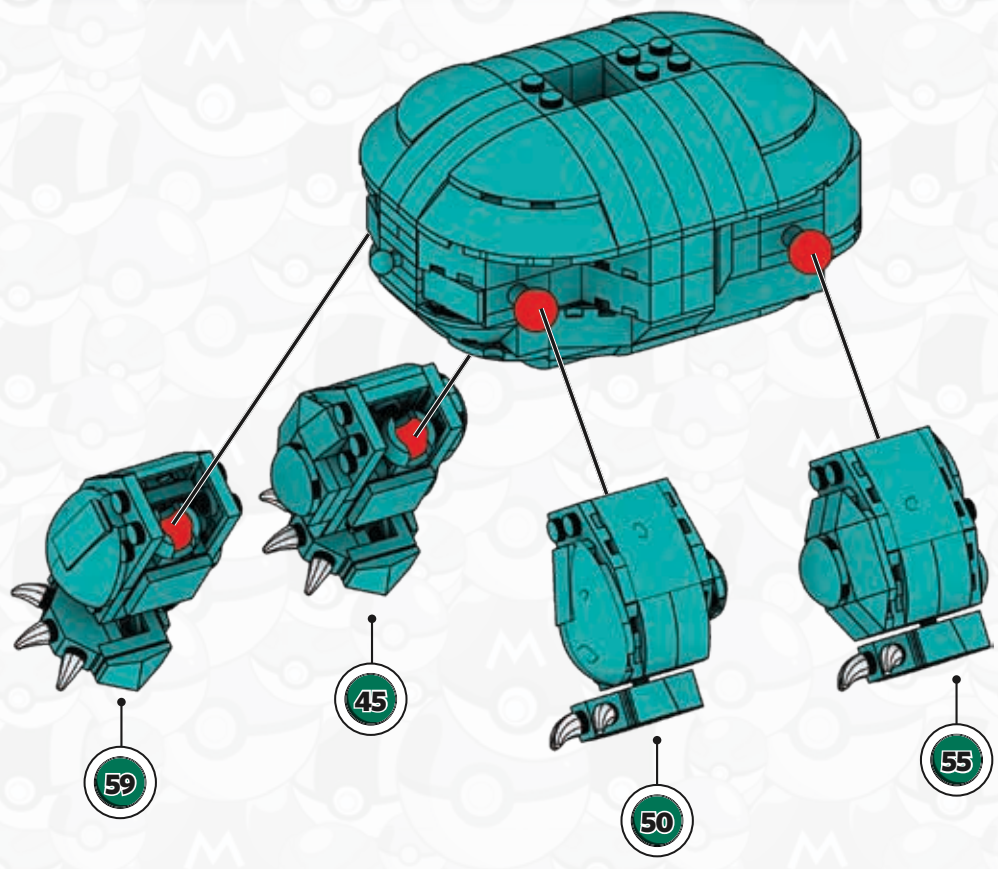

1

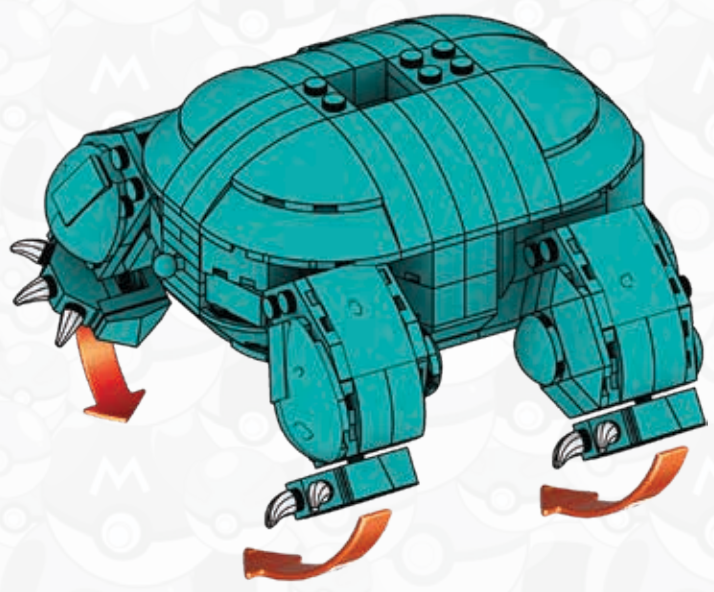

2

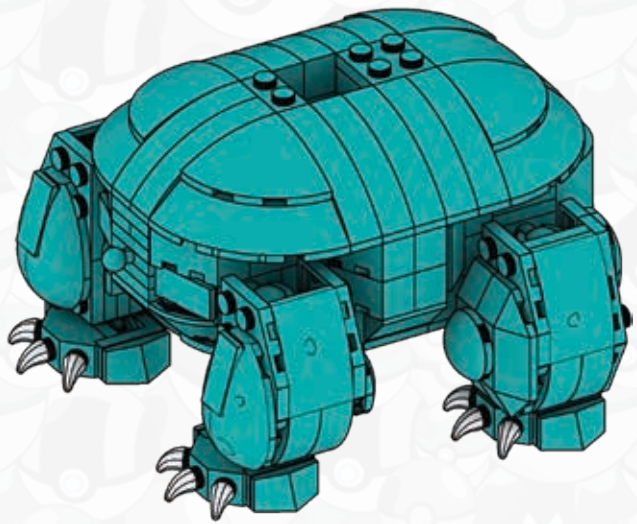

3



61

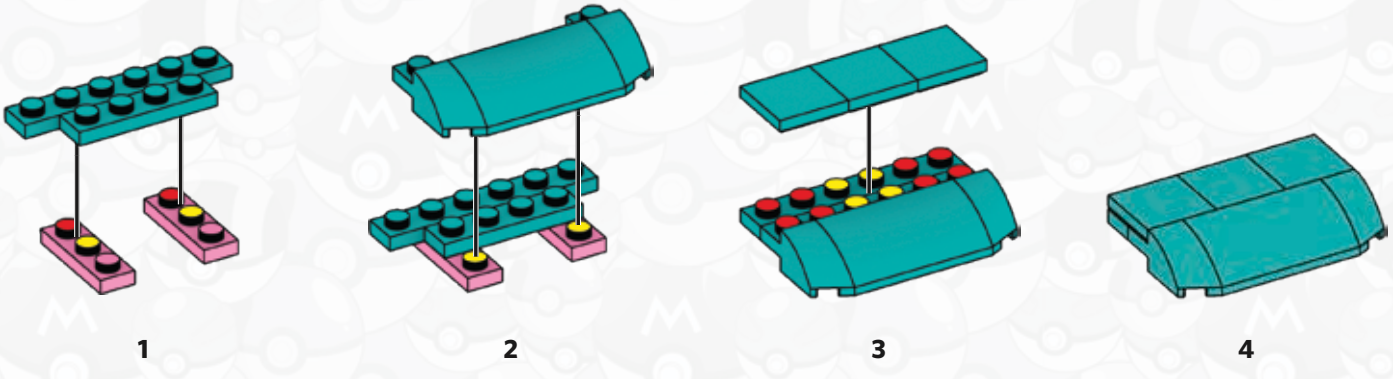
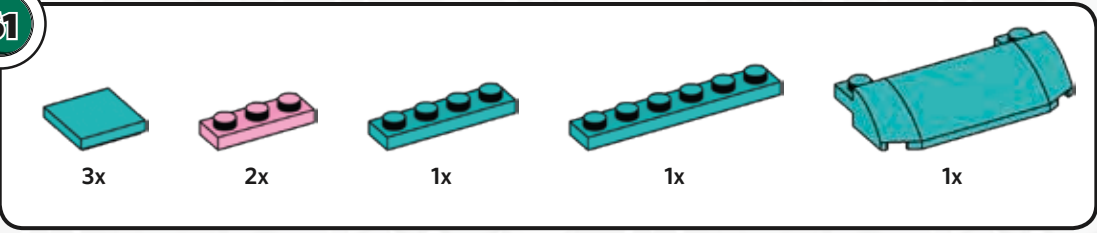

62

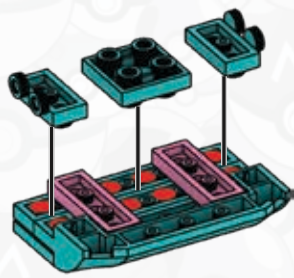
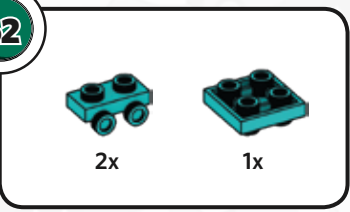

63

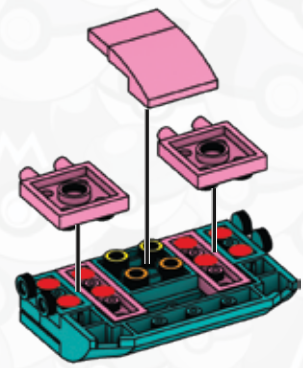
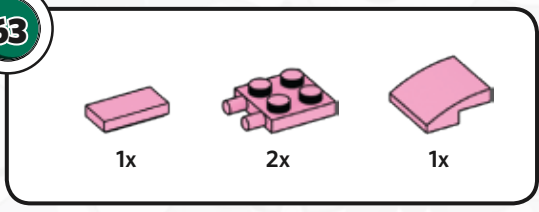

64

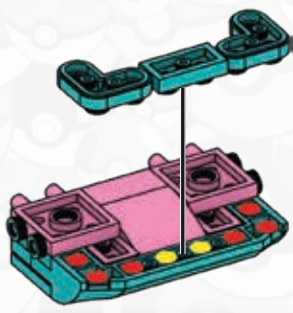
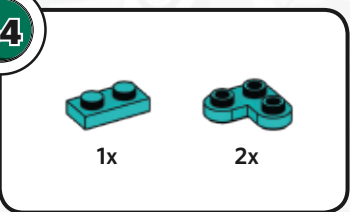



65



4x

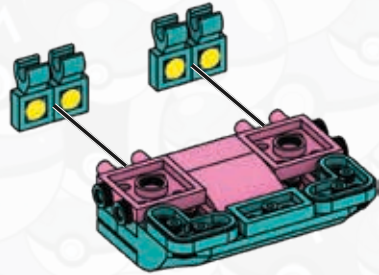

66



4x

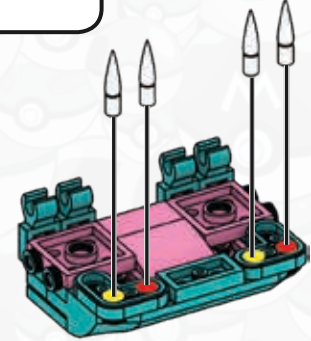

67



2x



1x



1x



2x



2x

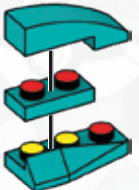

1



2

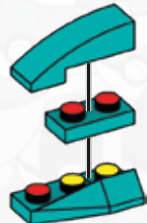

1



2

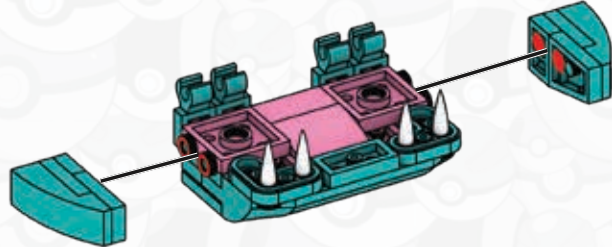

1

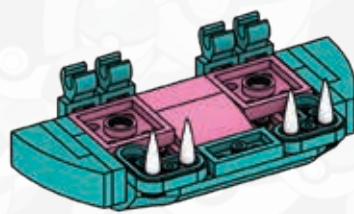

2





68

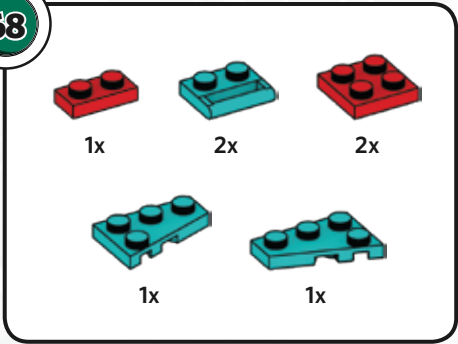

69

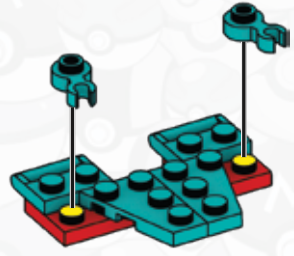
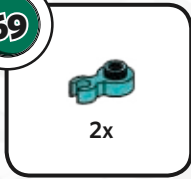

70

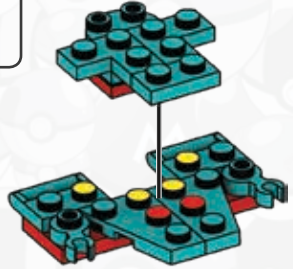
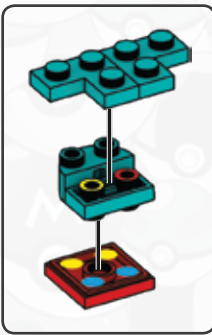
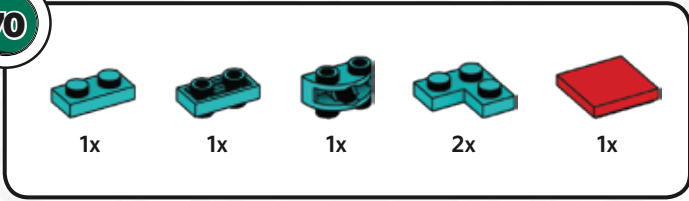

71

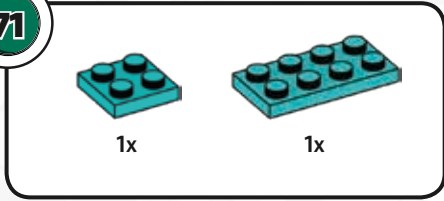



72

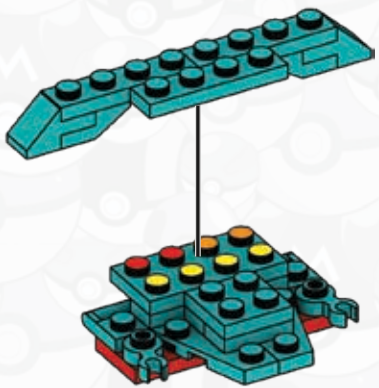
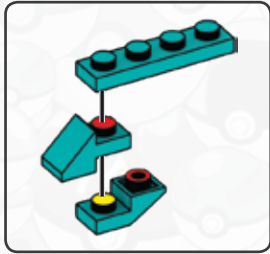
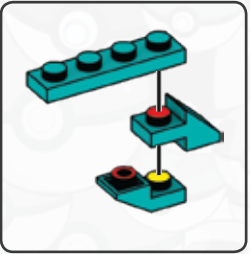
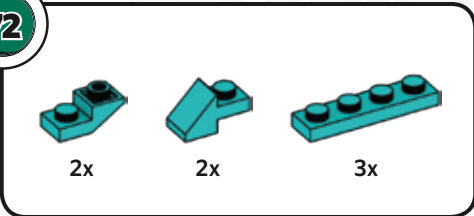

73

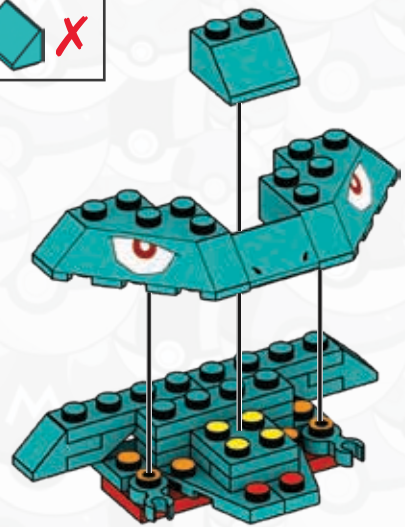
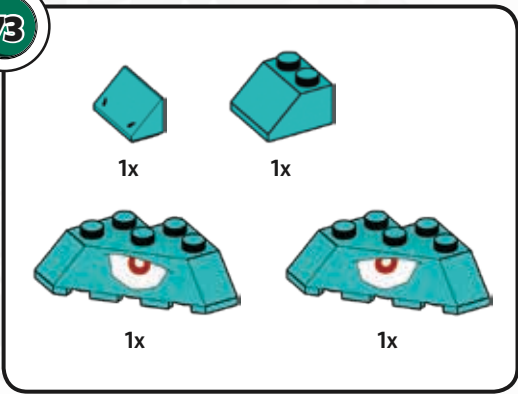

74

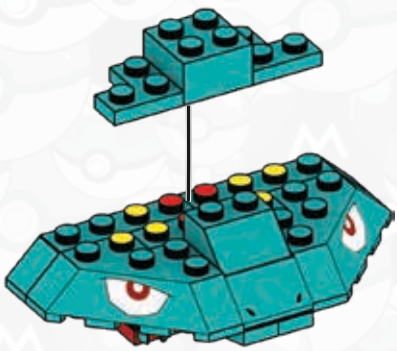
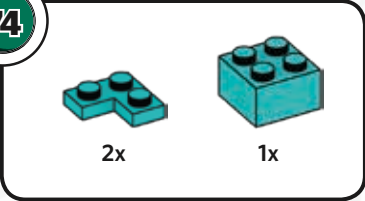

75

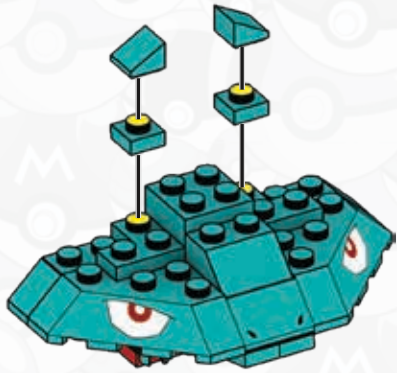
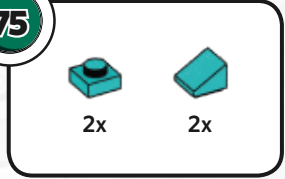



76

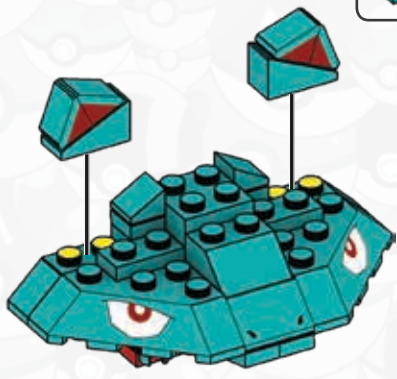
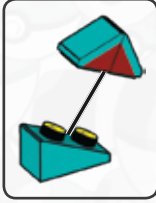
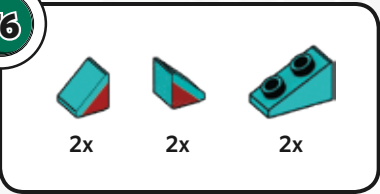

77

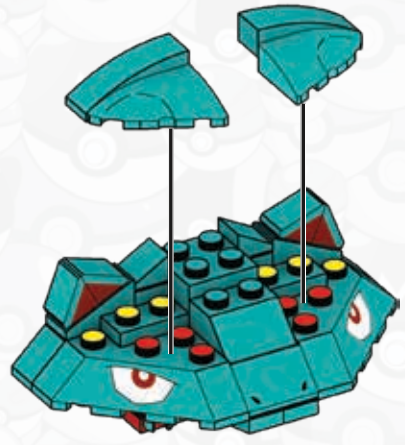
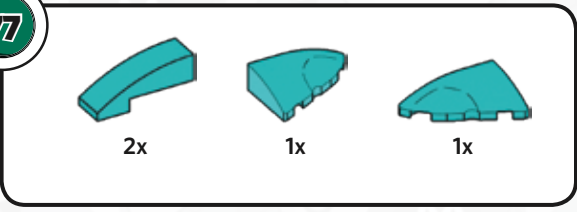

78

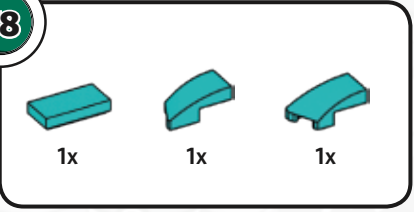

1

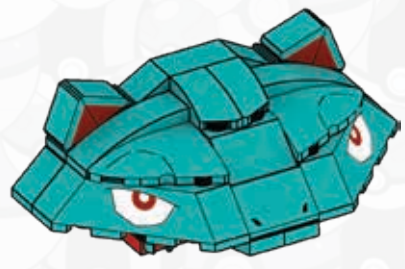

2





79



2x

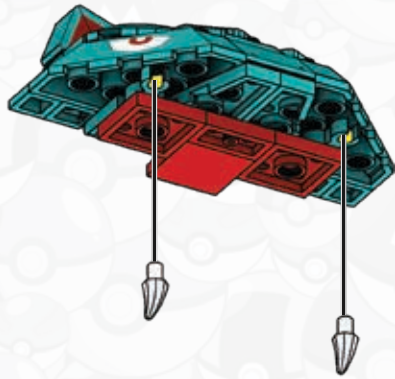

1



2

80

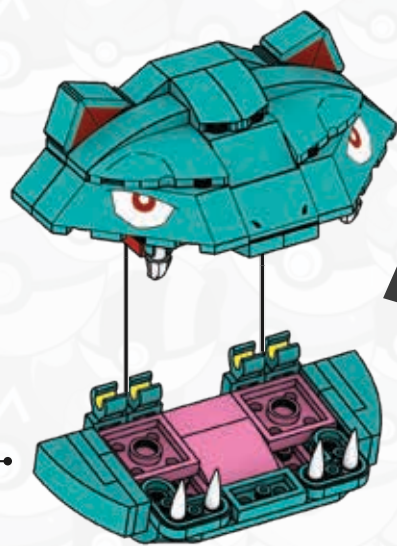

1

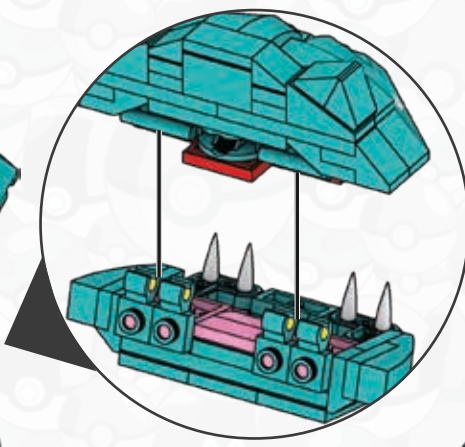

2

67

81

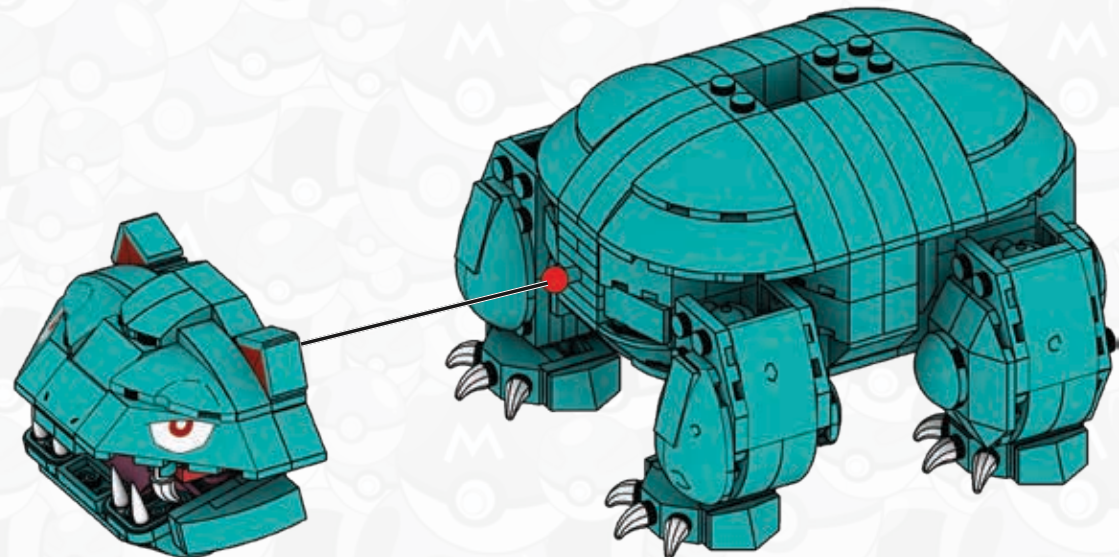



82

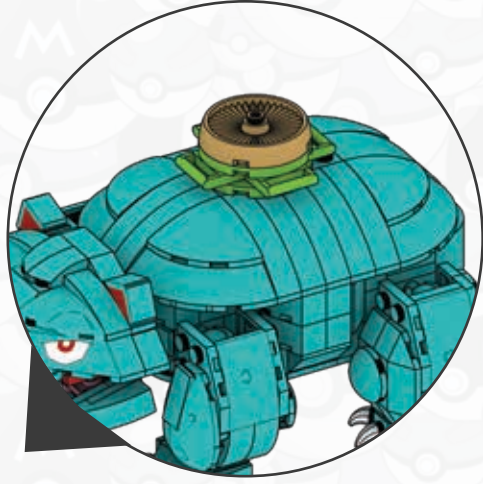
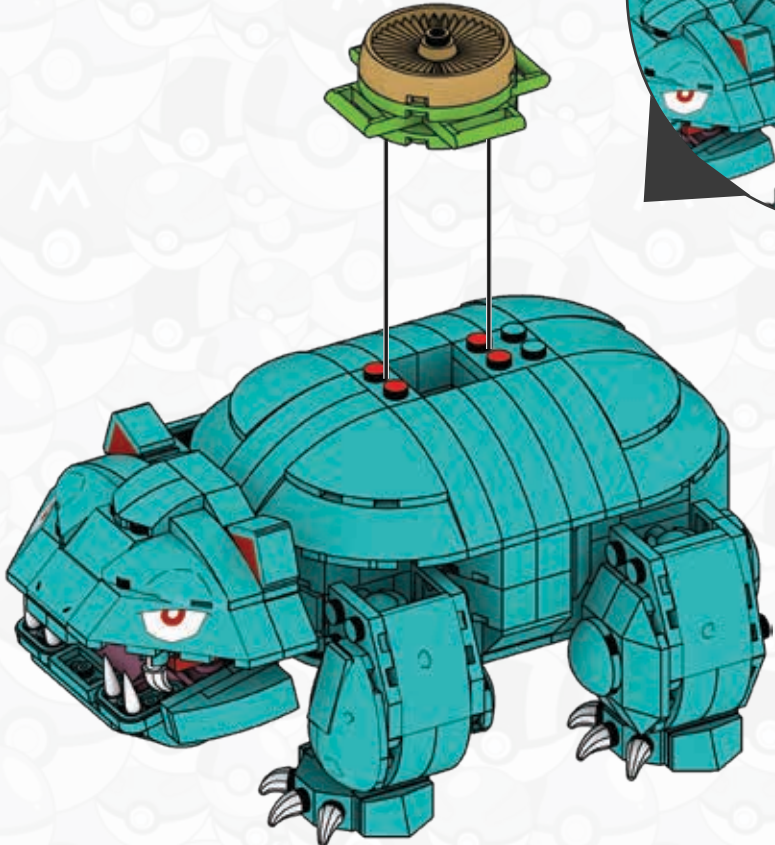
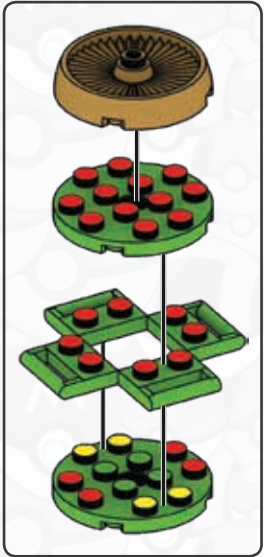
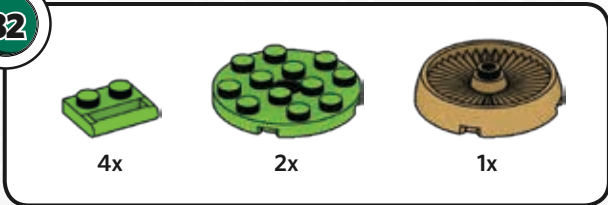

83

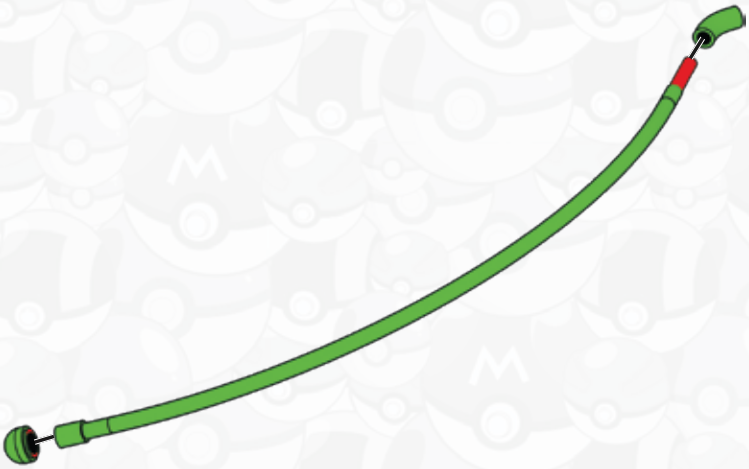
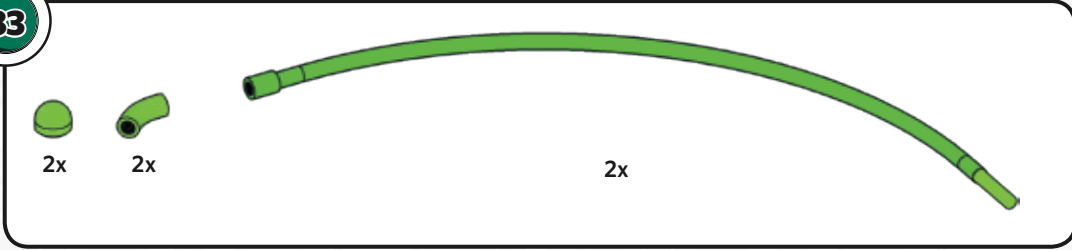

x2



84

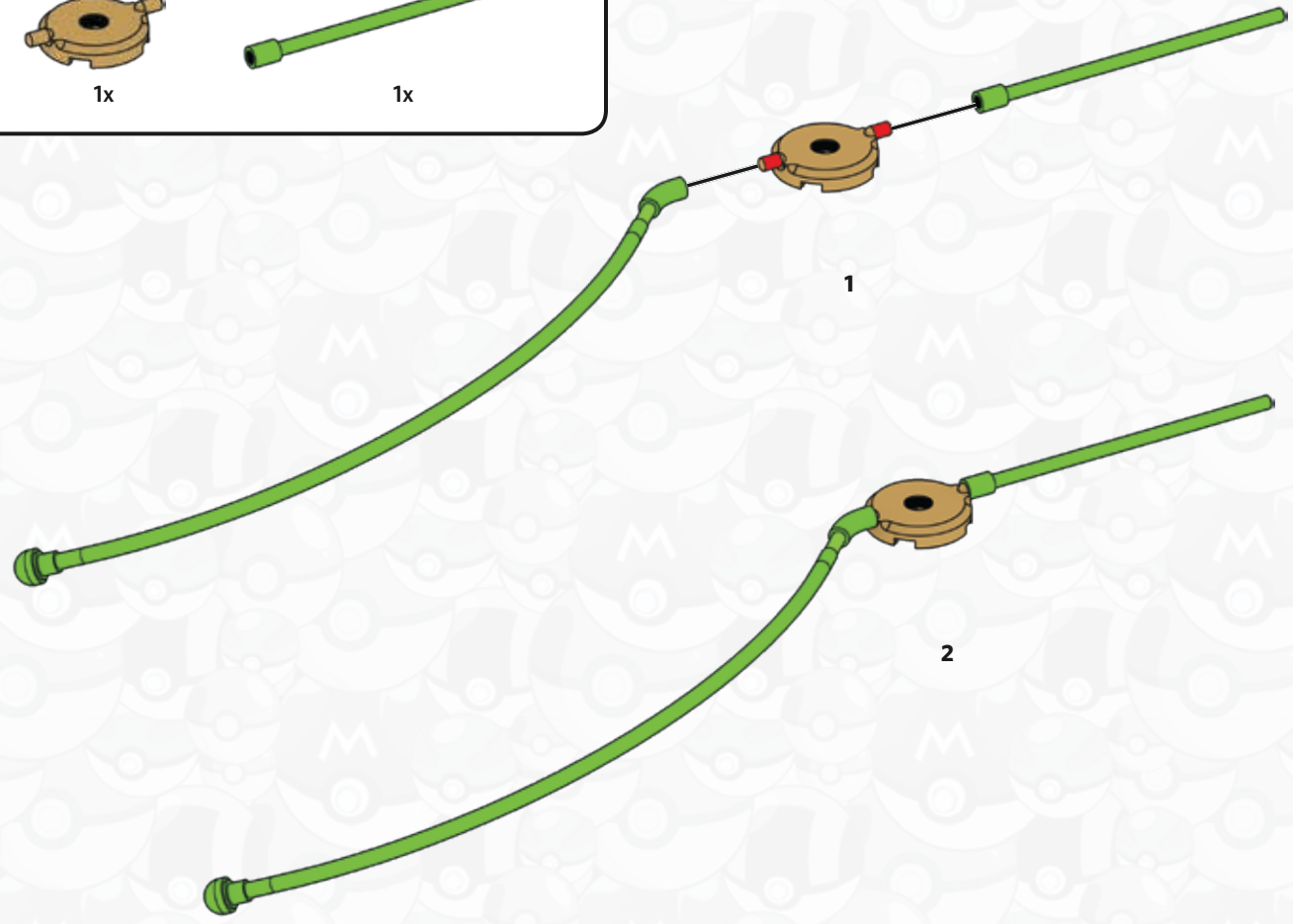
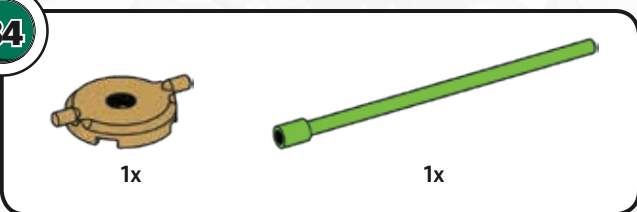

85

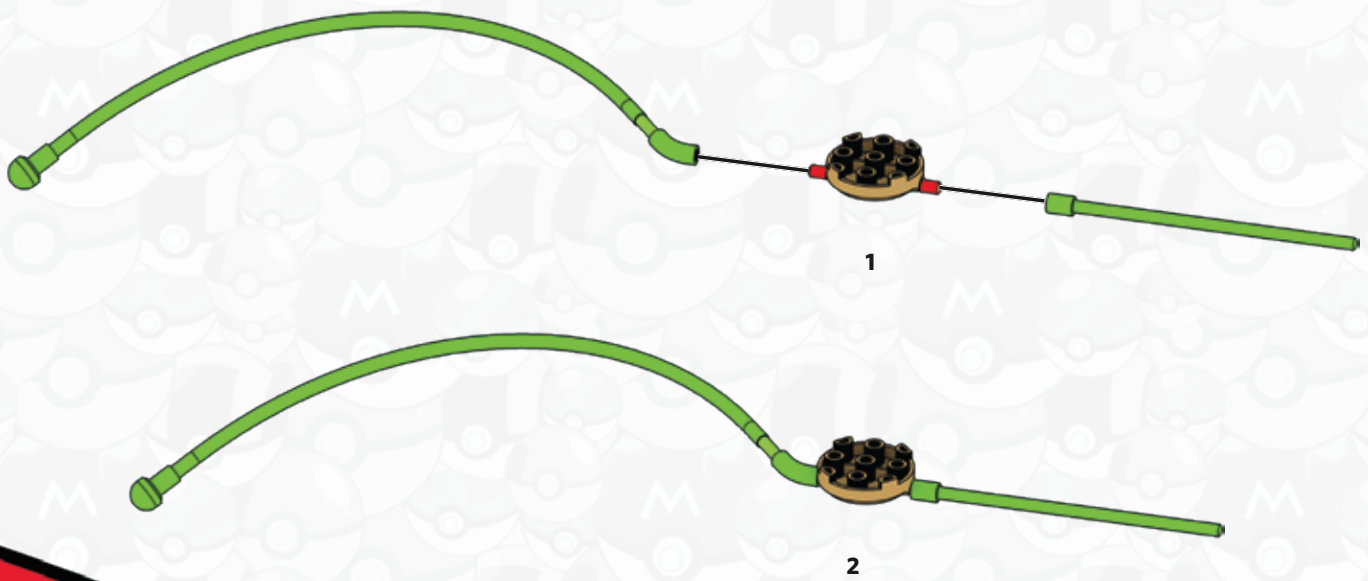
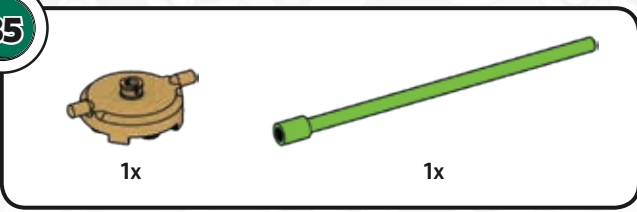



86

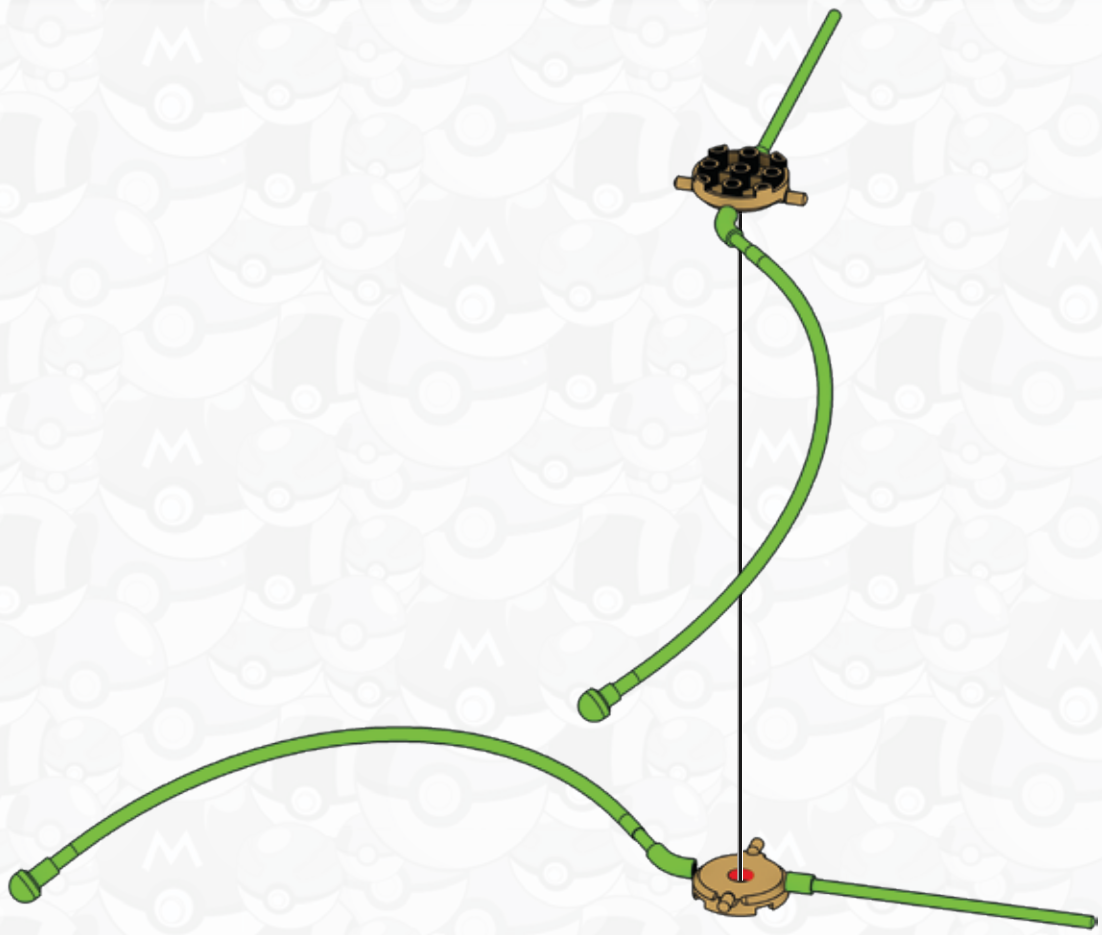

1

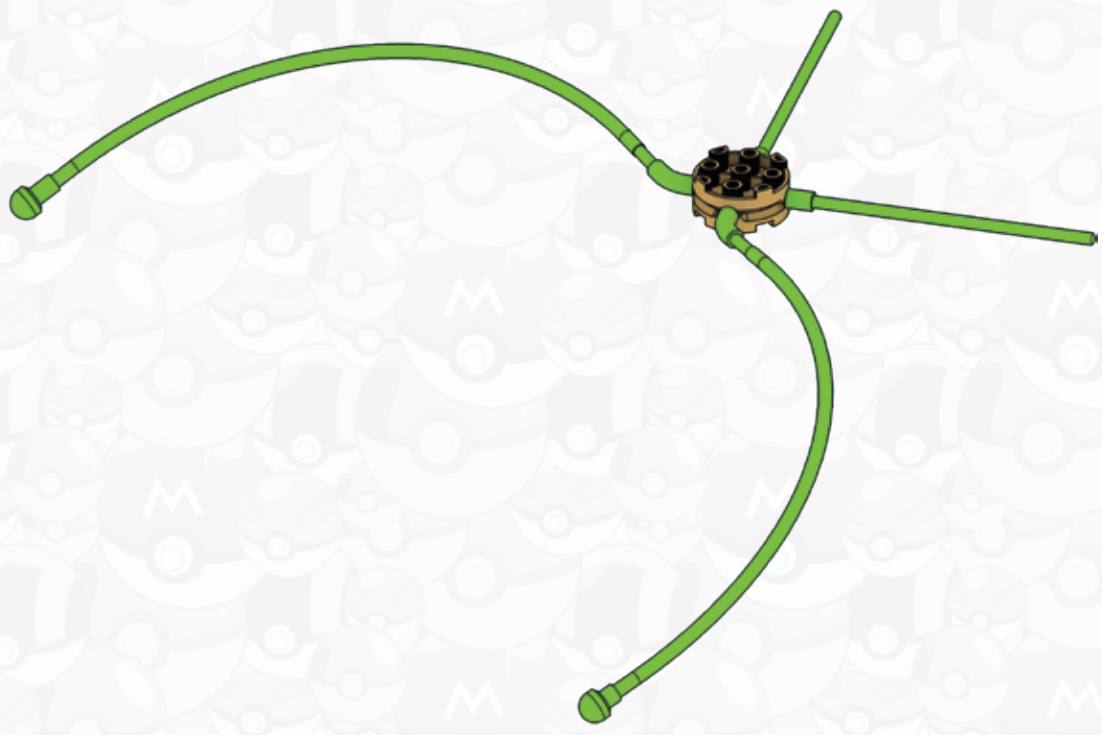

2





87



1x



2x



1x

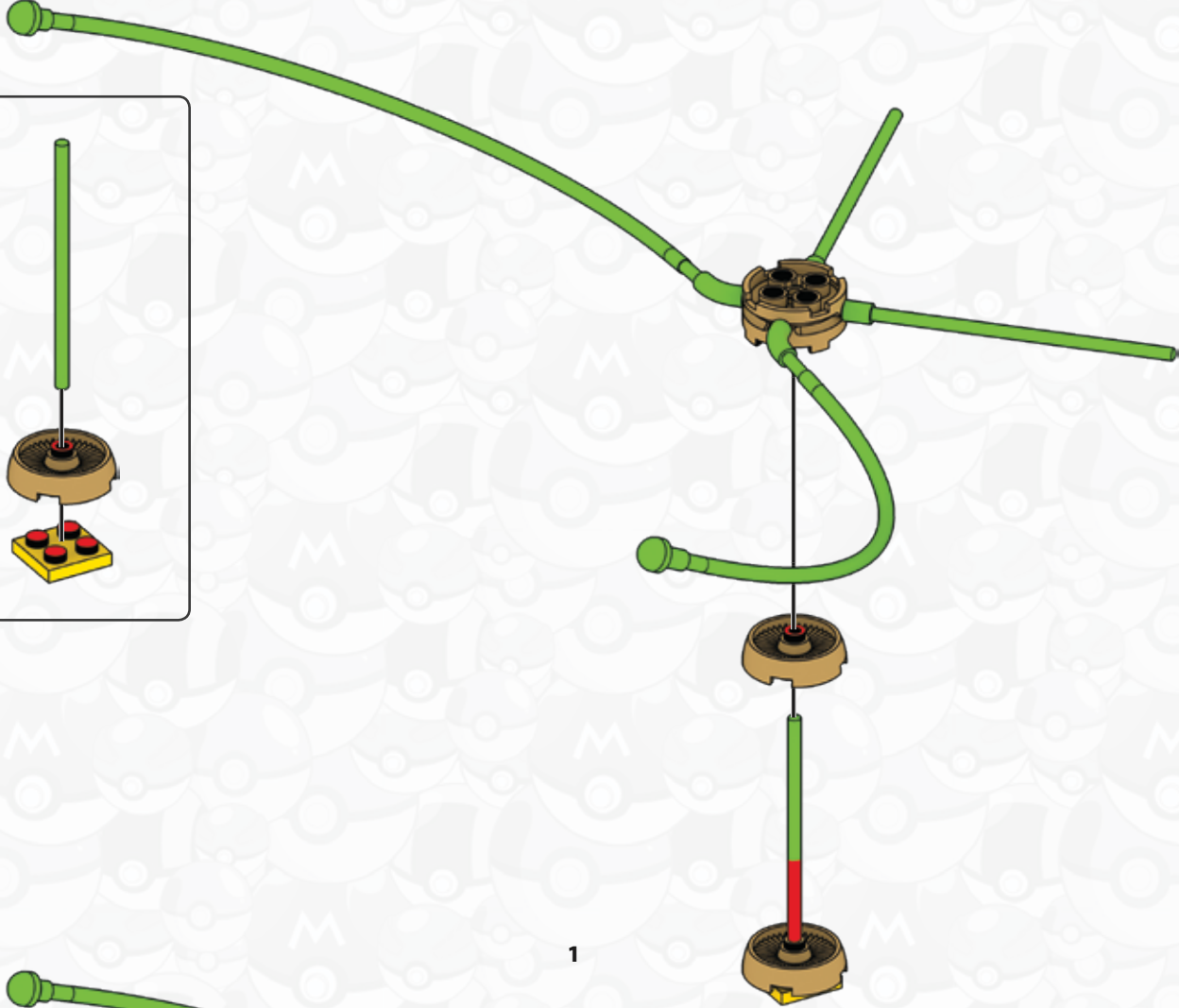
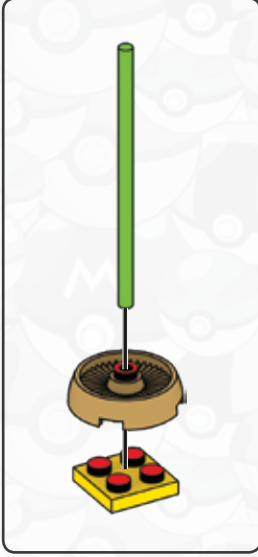

1

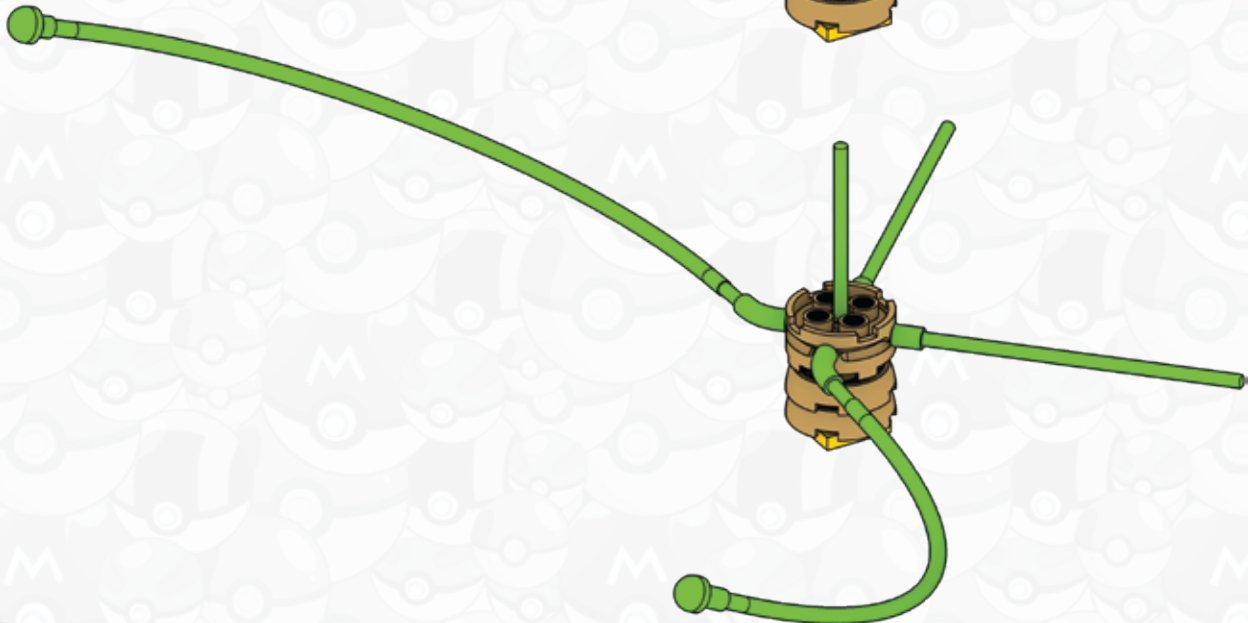

2





88

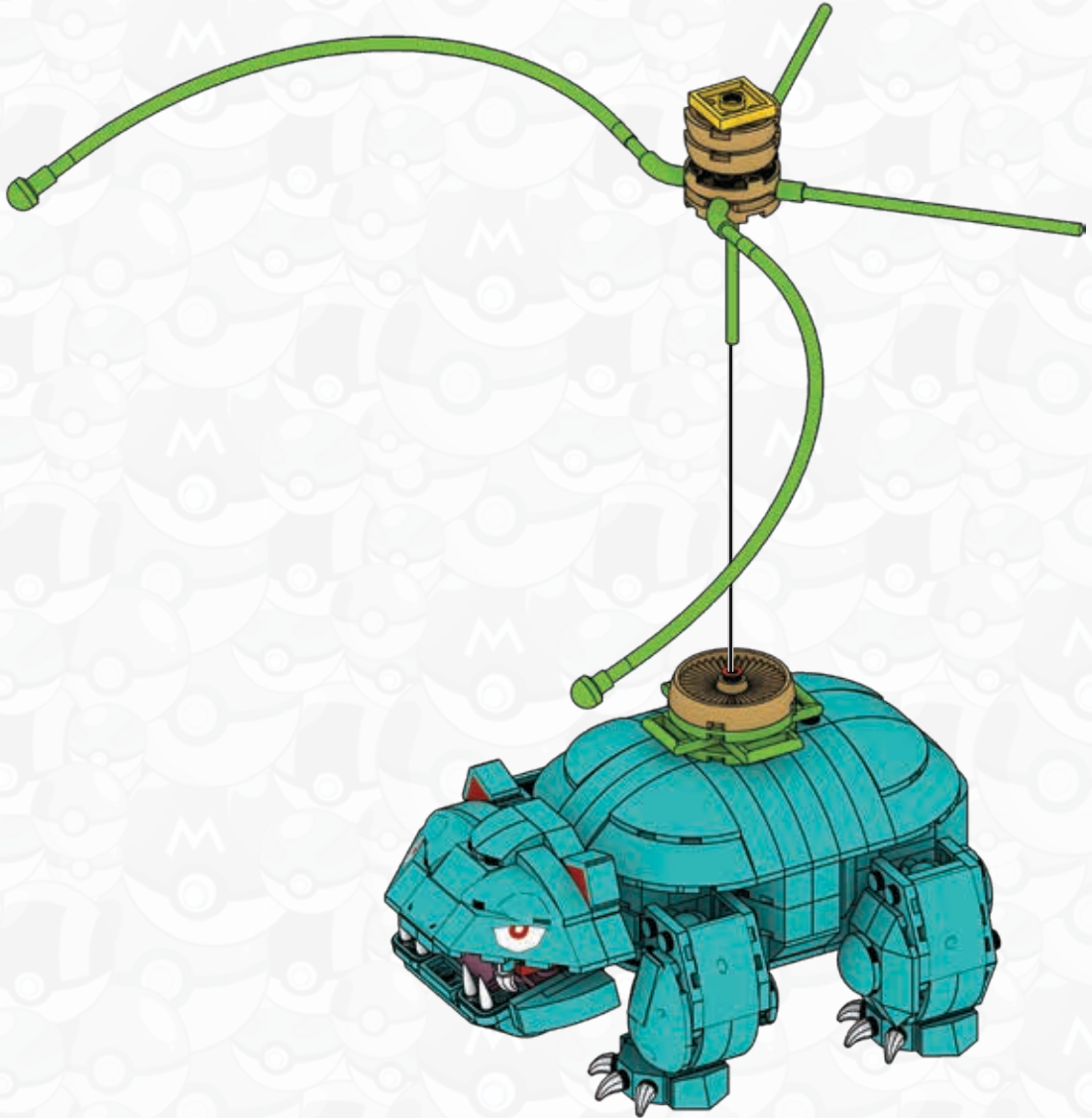

1

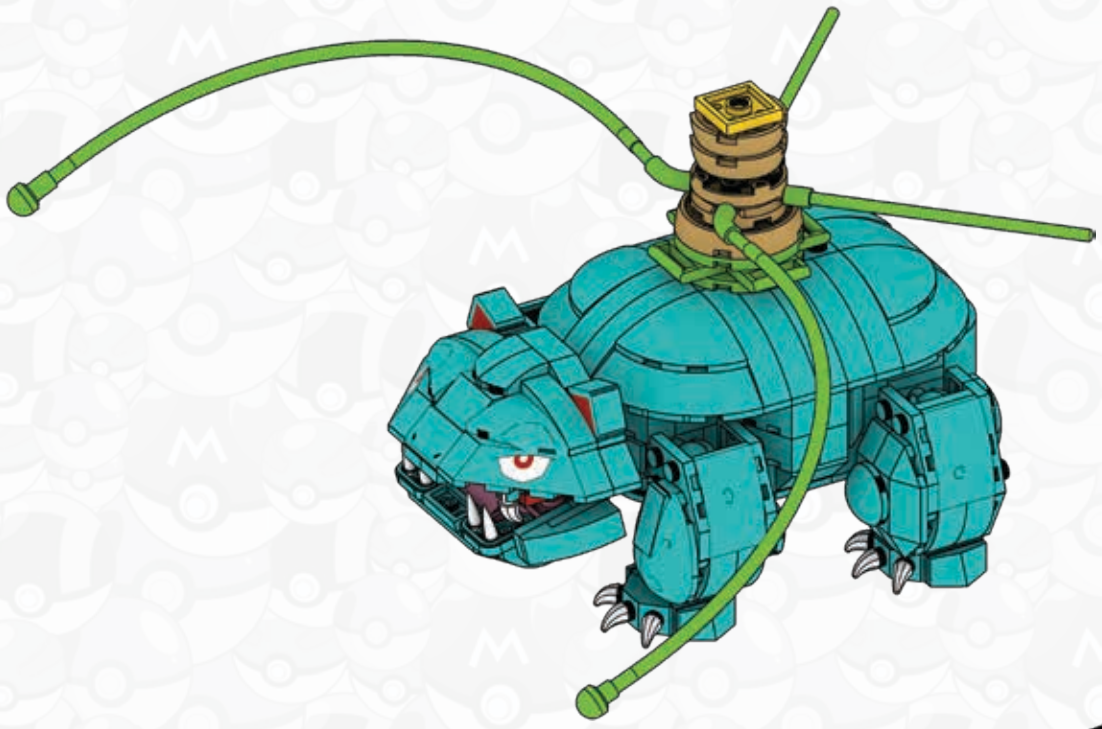

2





89

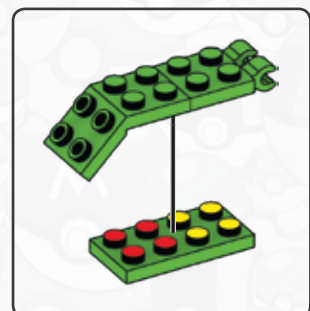
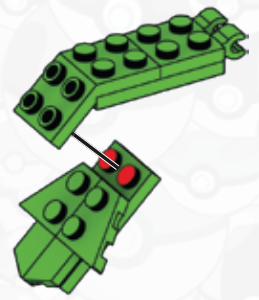
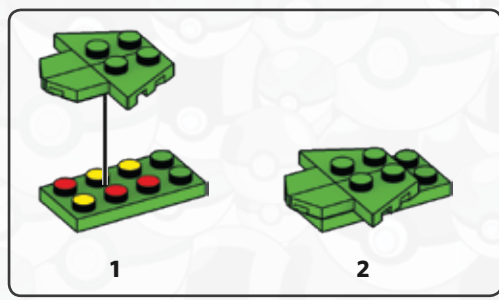
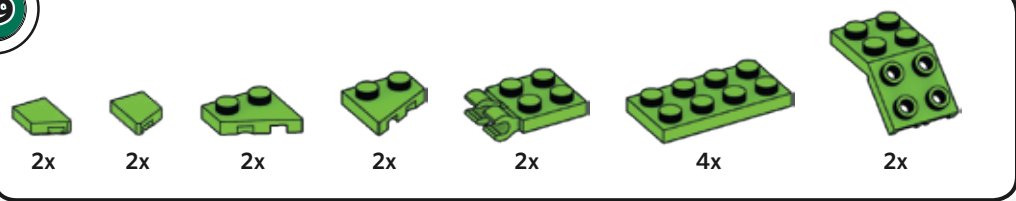

x2

90

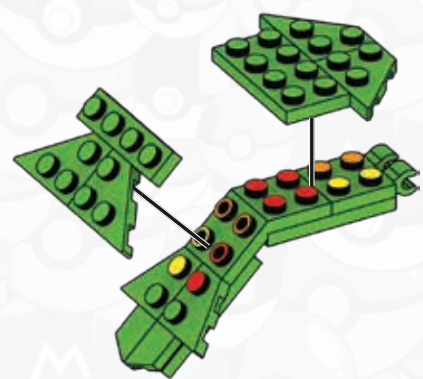
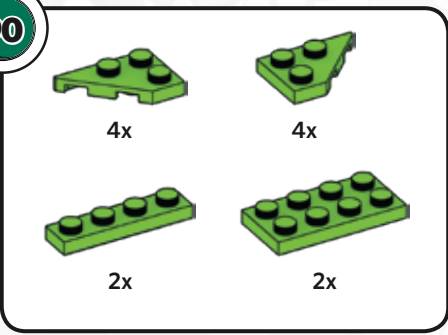

x2

91

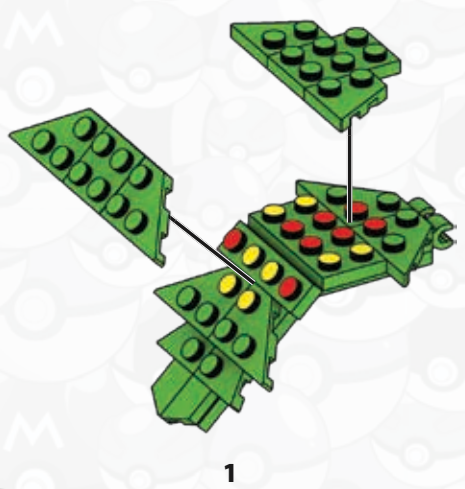
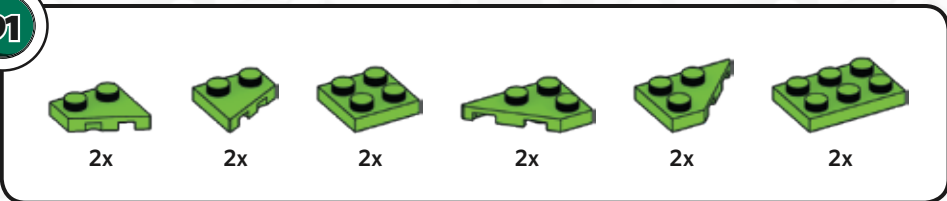

x2





92

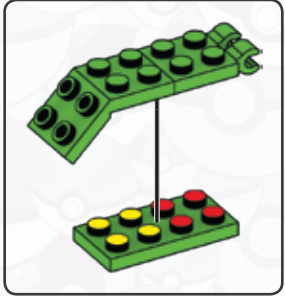
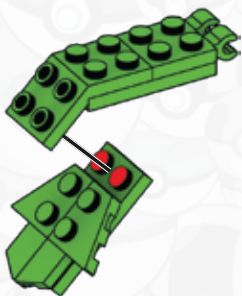
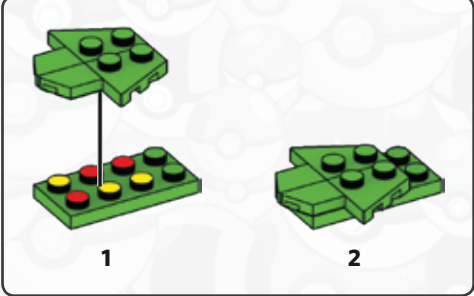
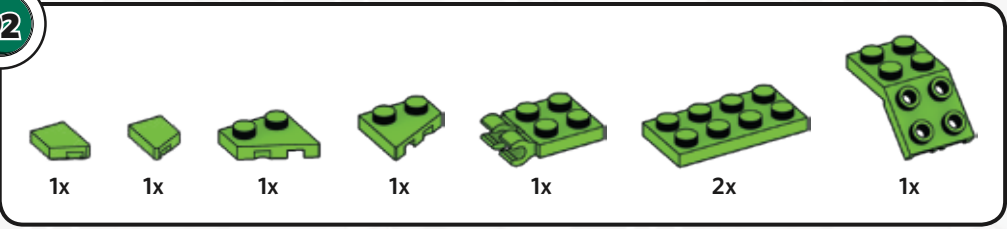

93

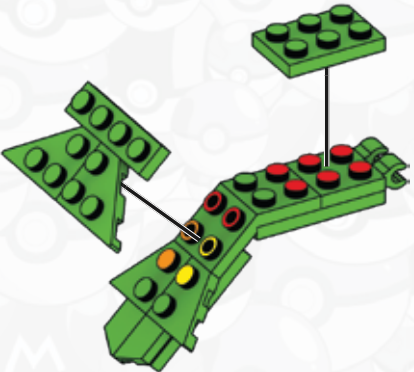
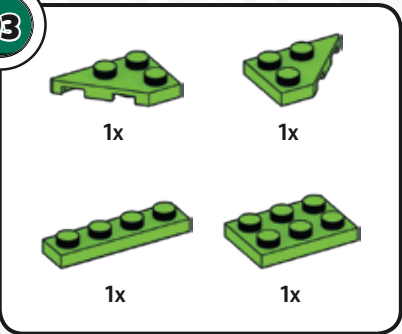

94

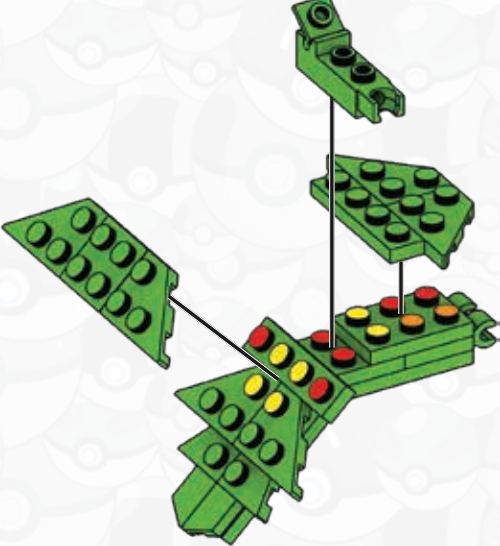
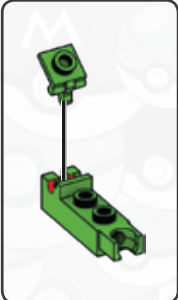
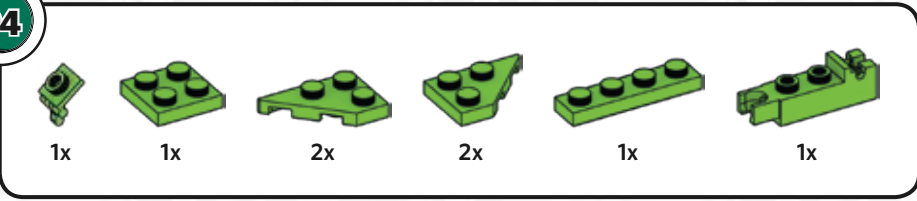



95

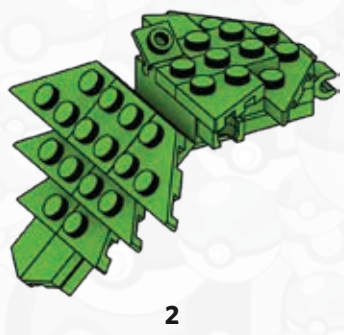
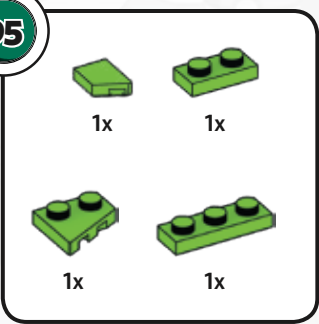

96

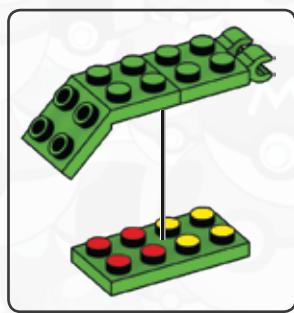
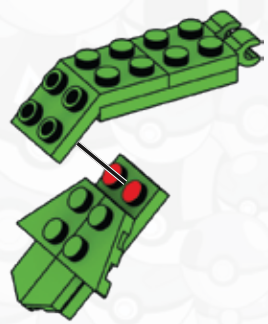
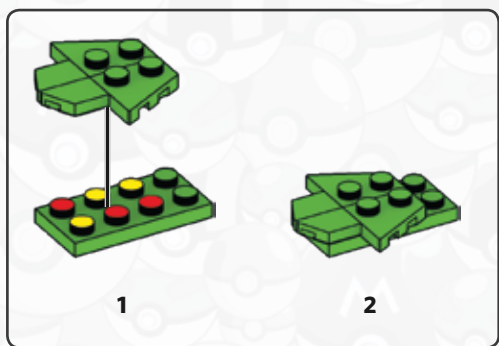
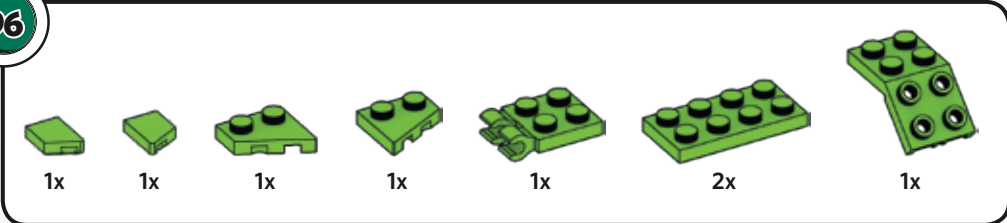

97

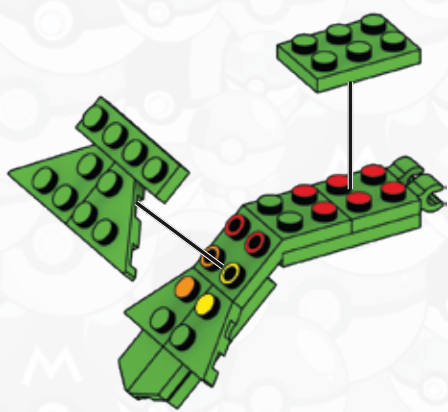
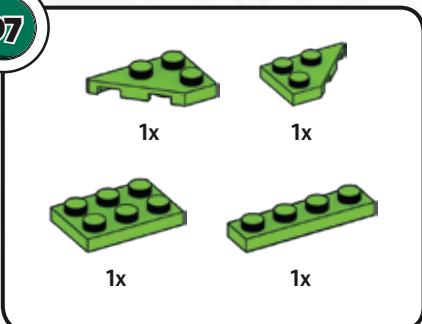



98

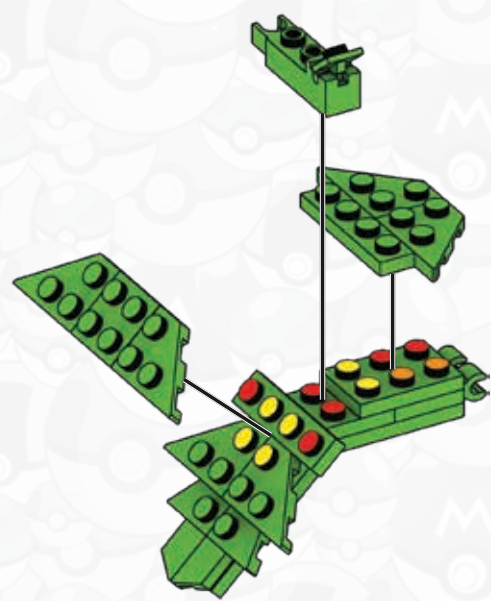
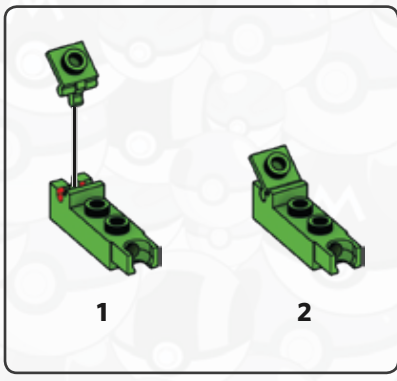
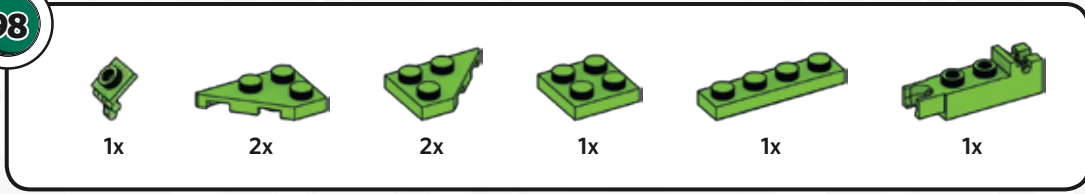

99

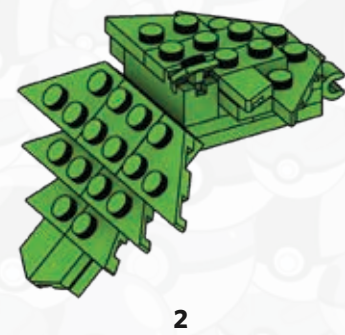
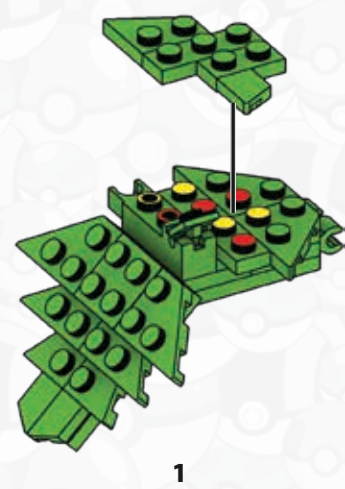
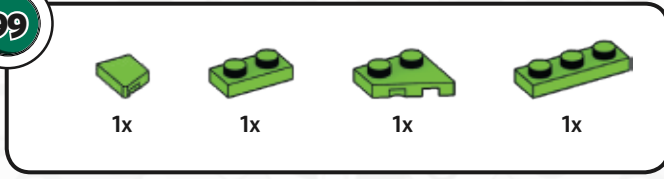



100

95

91



91

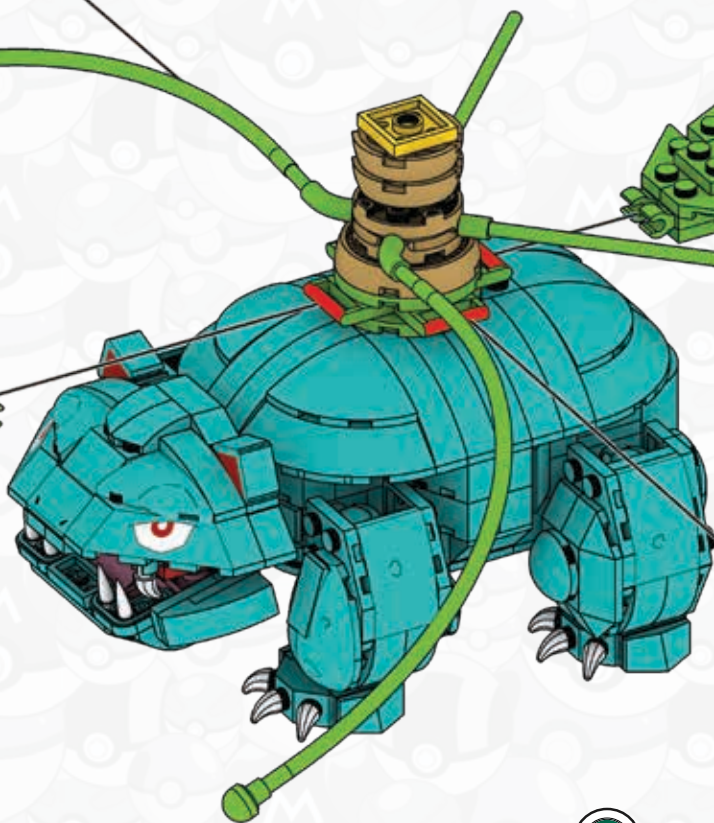

99





101



1x



4x



8x



1x

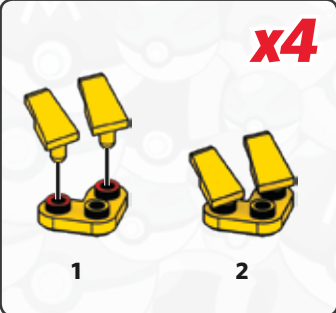

102



2x

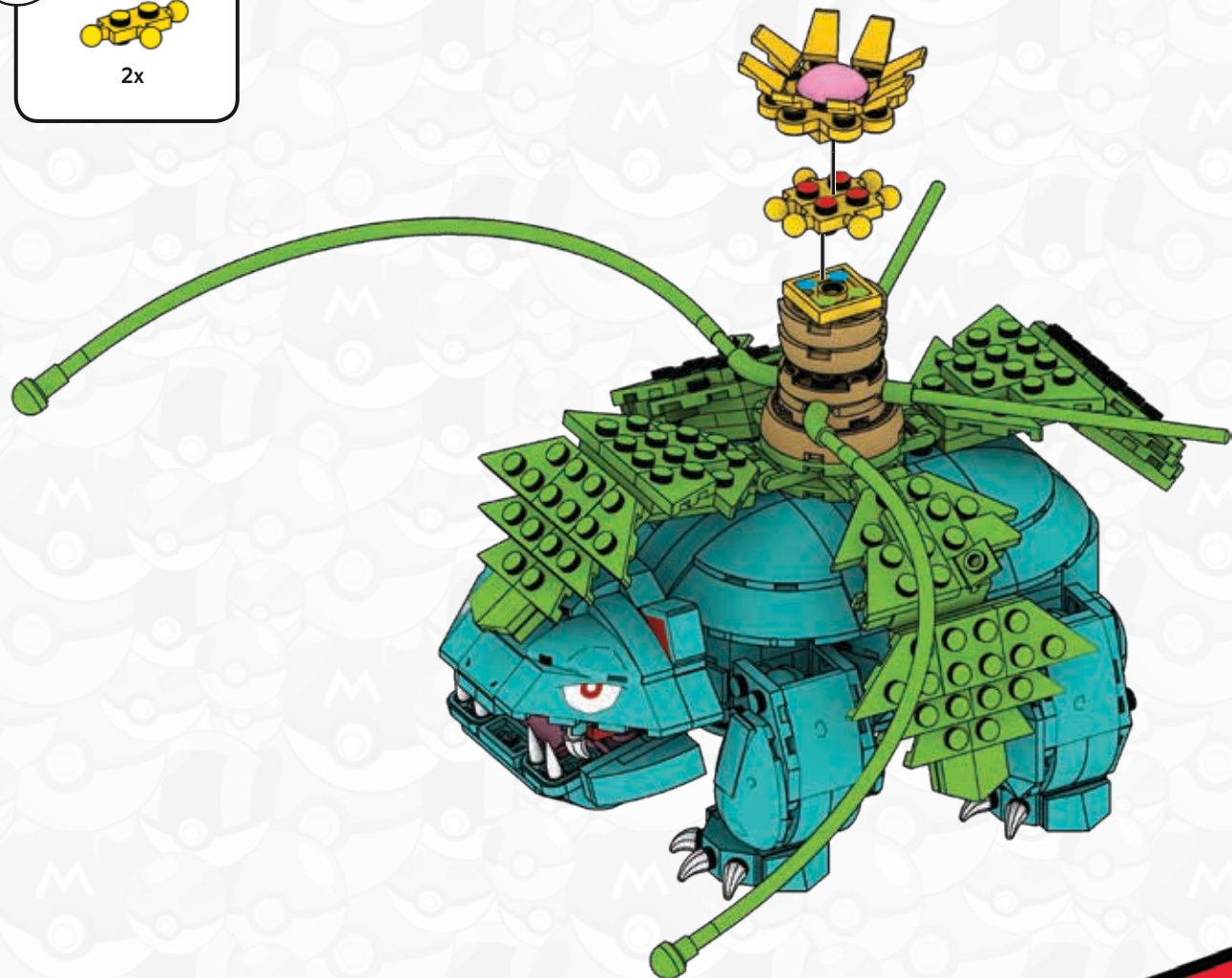



103

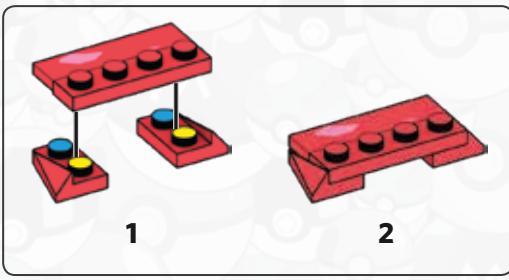
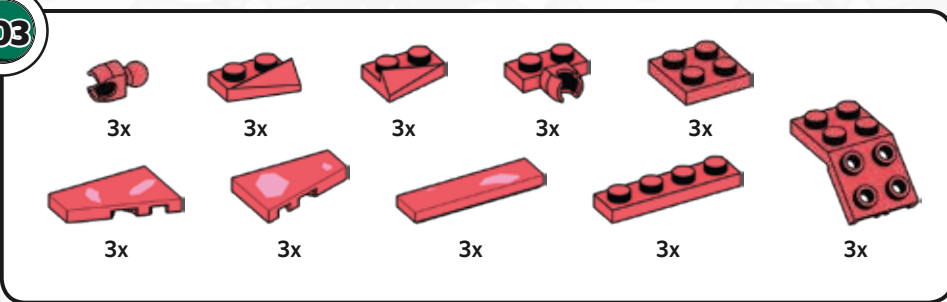

x3

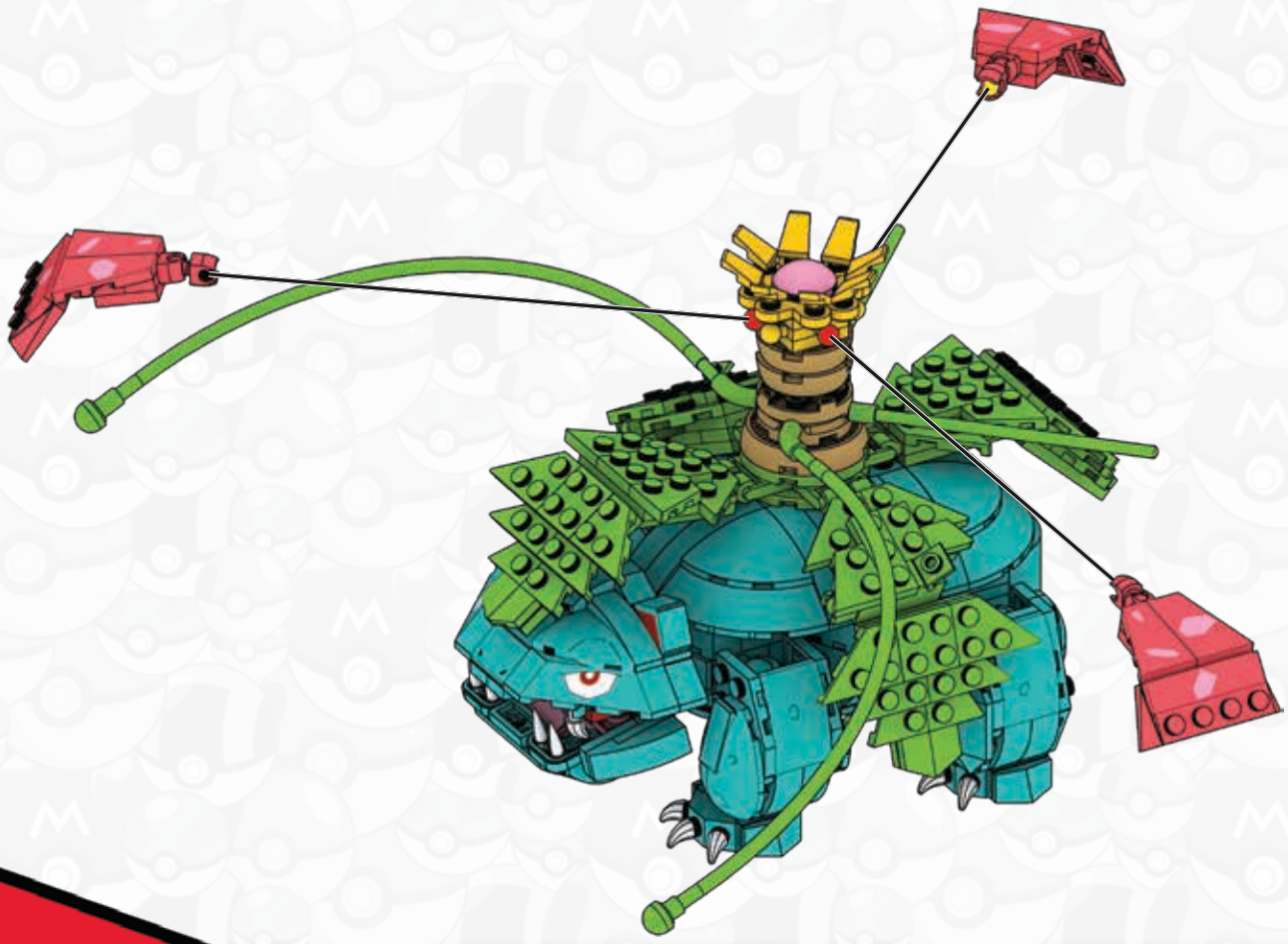
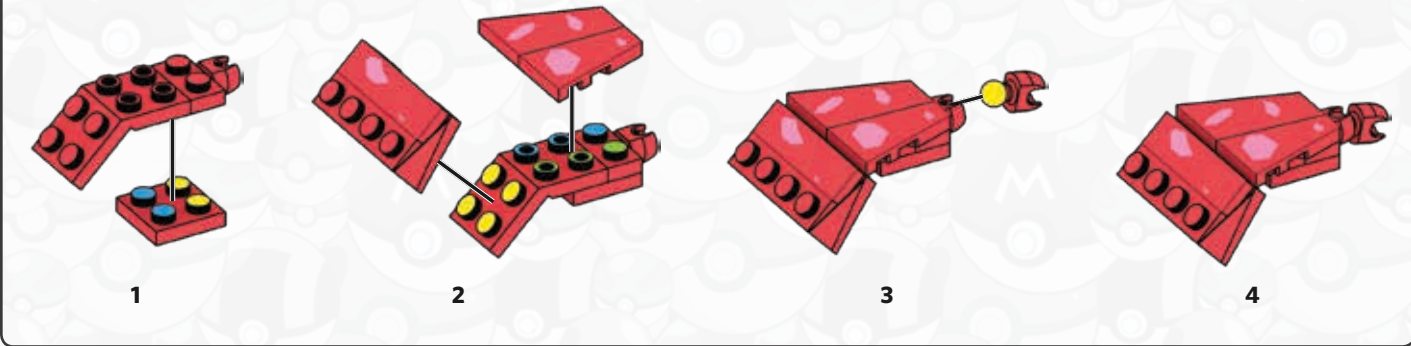



104

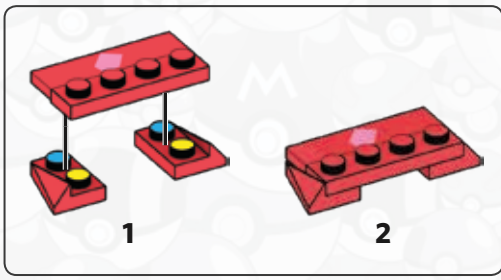
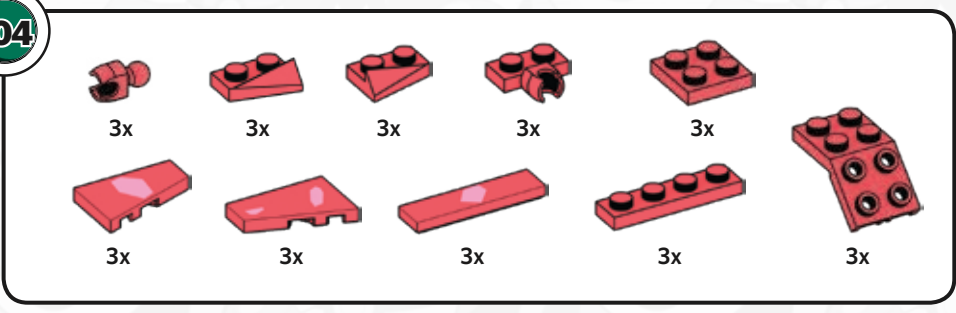

x3

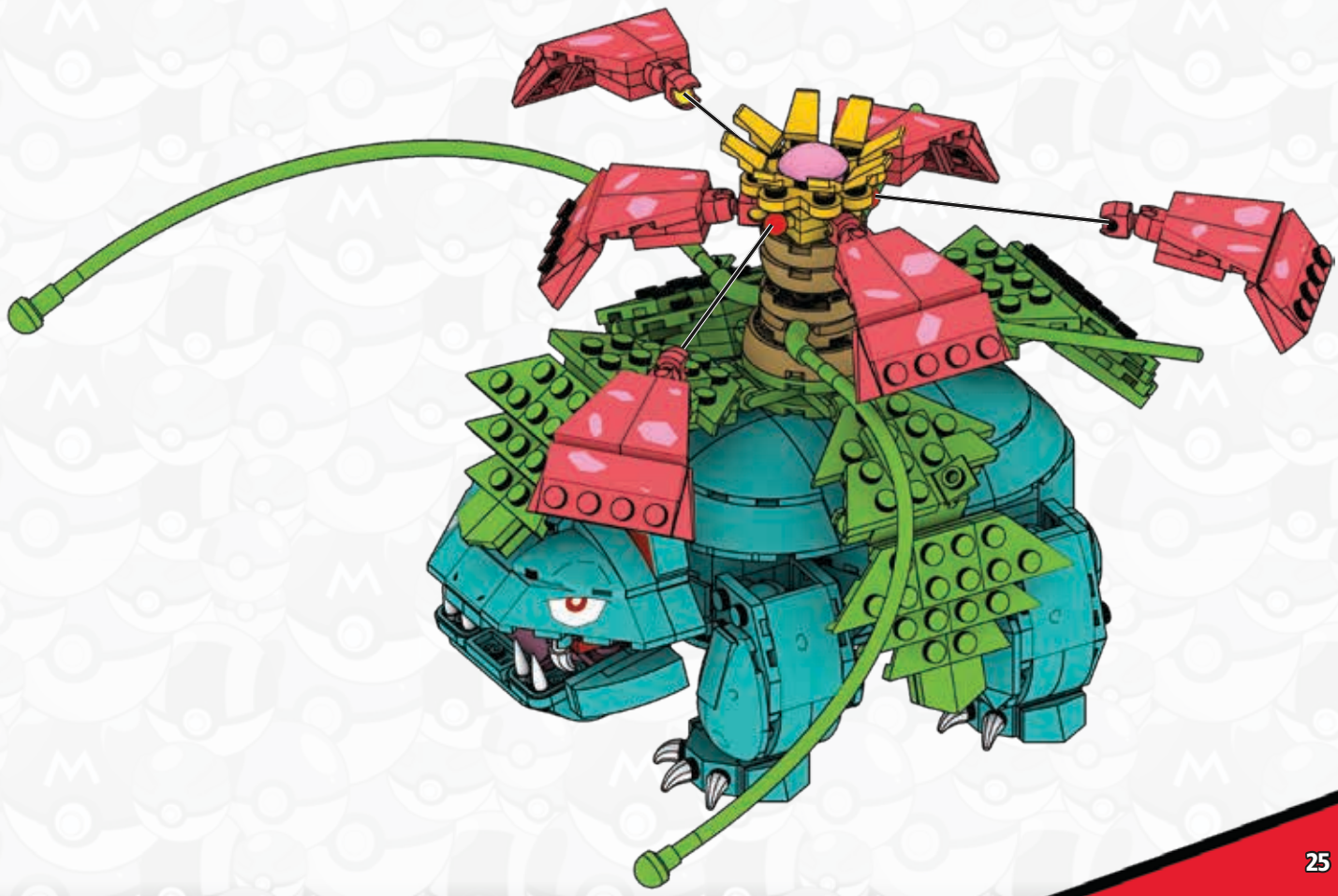
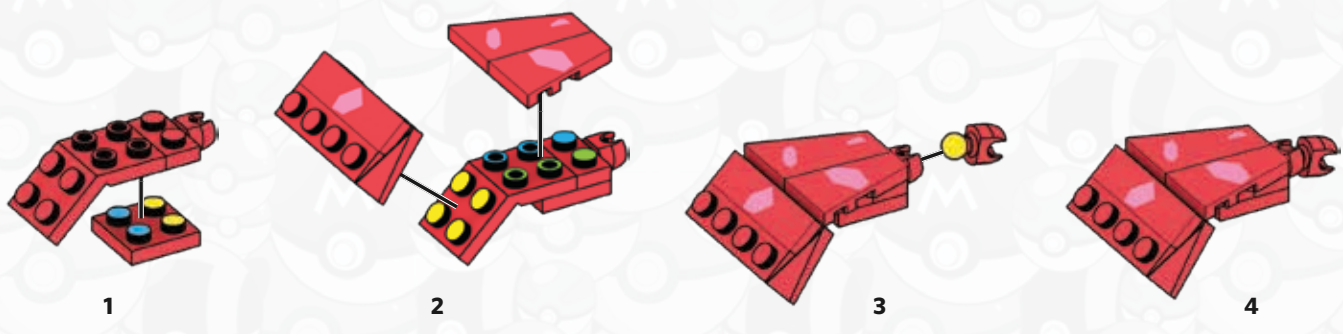



105

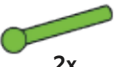

2x

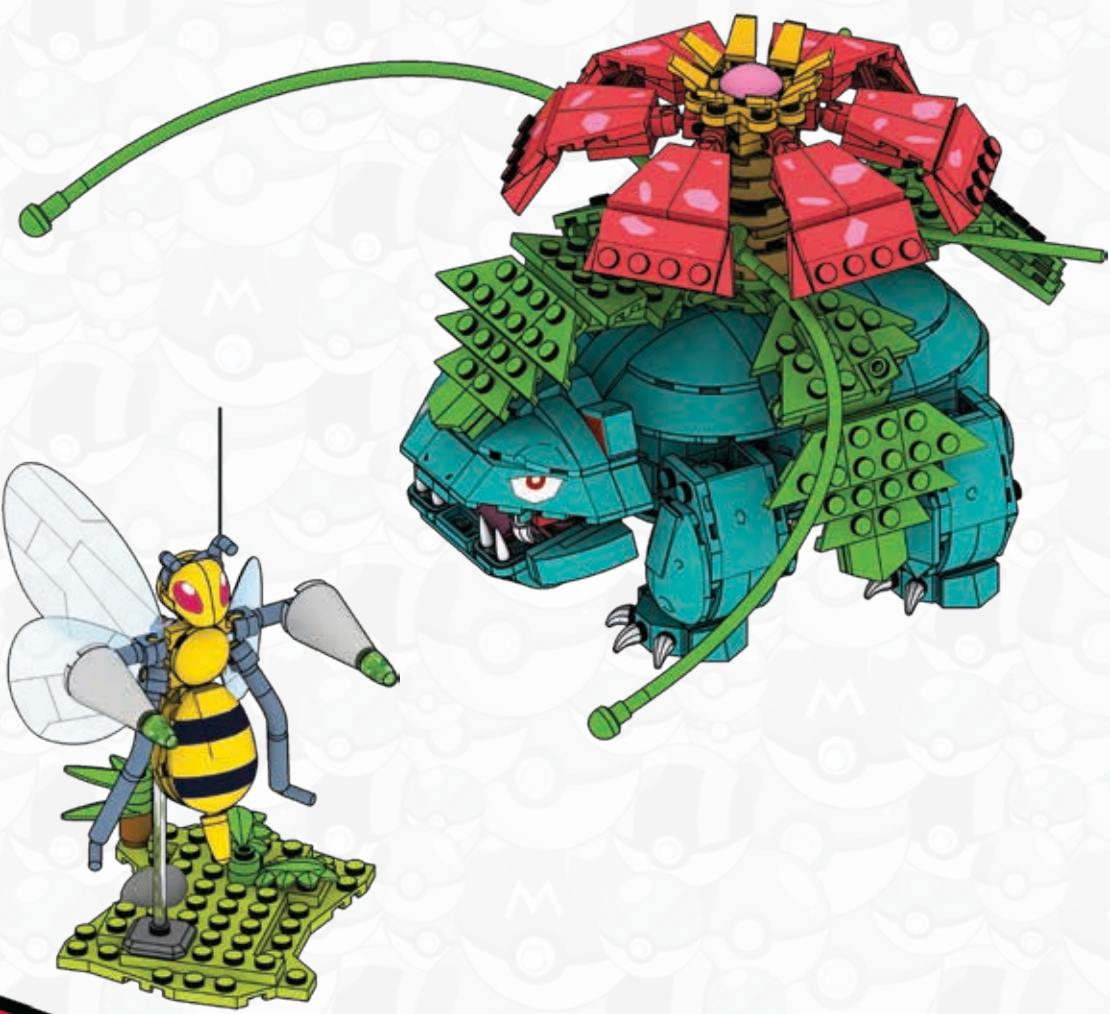
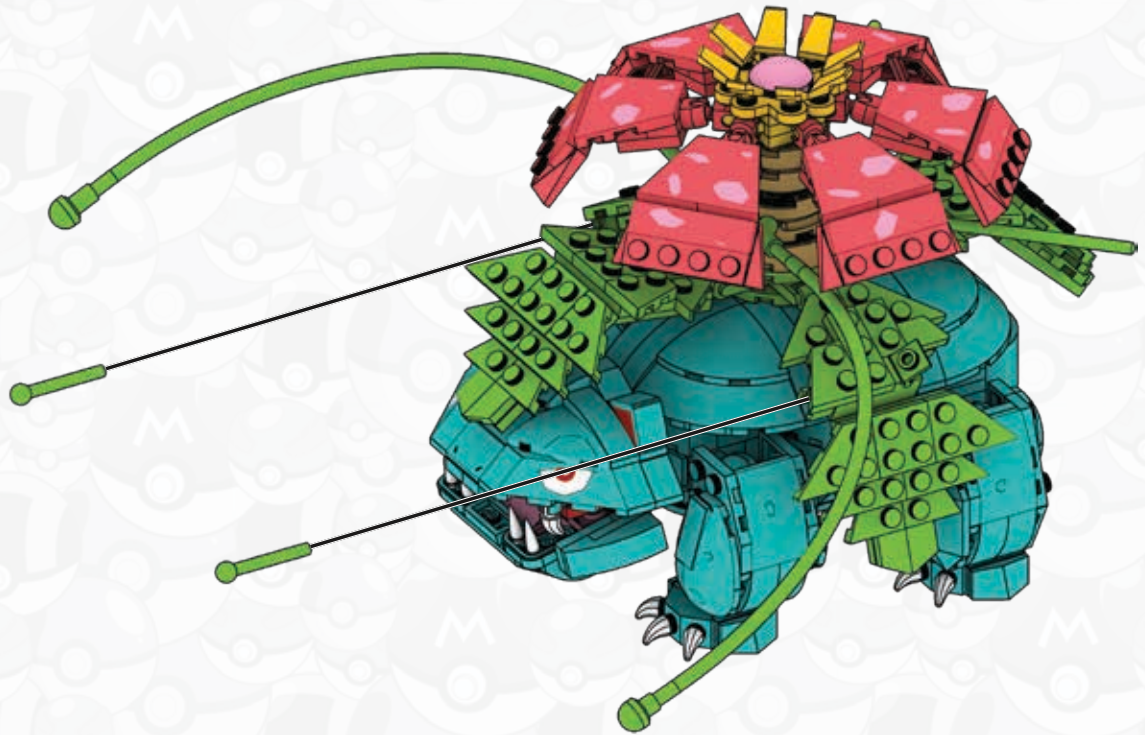





Warning: Do not aim at eyes or face. Only use projectiles supplied with this toy. Do not fire at point blank range.
Attention: Ne pas viser les yeux ou le visage. Ne pas utiliser d'autres projectiles que ceux fournis avec ce jouet. Ne pas tirer à bout portant.
Advertencia: No apuntar hacia los ojos o la cara. Utilizar exclusivamente los proyectiles suministrados con este juguete. No disparar a quemarropa.
Atenção: Não apontar em direção aos olhos ou ao rosto. Usar apenas os projéteis fornecidos com este brinquedo. Não disparar à queima-roupa.
Avvertenza: Non mirare agli occhi o al viso. Usare solo i proiettili forniti con il giocattolo. Non sparare a distanza ravvicinata.
Achtung: Nicht auf Augen oder Gesicht zielen. Nur die zu diesem Spielzeug gehörenden Projektile verwenden. Nicht auf Menschen oder Tiere oder aus nächster Nähe zielen.
Ostrzeżenie: Nie celuj w oczy i twarz. Nie strzelaj pociskami innymi niż dostarczone z zabawką. Nie strzelaj z bliska.
Waarschuwing: niet op ogen of gezicht richten. Gebruik uitsluitend de bijgeleverde projectielen. Niet van te dichtbij afschieten.
Предупреждение: Не направляйте в глаза или лицо. Используйте только снаряды, входящие в комплект. Не стреляйте со слишком близкого расстояния.
Advarsel: Sigt ikke mod øjne eller ansigt. Brug kun de projektiler, som følger med legetøjet. Skyd ikke direkte på personer eller ting.
Varning: Sikta inte mot ögon eller ansikte. Använd endast projektiler som medföljer leksaken. Fyra inte av på mycket nära håll.
Advarsel: Du må ikke sikte mot øyne eller ansikt. Bruk bare prosjektilene som følger med leken. Ikke skyt på noe på kloss hold.
Varoitus: Älä tähtää silmiin äläkä kasvoihin. Käytä ainoastaan tämän tuotteen mukana tulleita ammuksia. Älä ammu lähietäisyydeltä.
Προσοχή: Μην στοχεύετε στα μάτια ή στο πρόσωπο. Χρησιμοποιείτε μόνο τα βλήματα που περιλαμβάνονται. Μην στοχεύετε όταν δεν έχετε ορατότητα.
Uyarı: Göze veya yüze nişan almayın. Fırlatmak için yalnızca bu oyuncakla birlikte verilen objeleri kullanın. İnsanlara ve hayvanlara nişan almayın.
警告: 请勿对着眼睛或脸部发射。仅使用本玩具自带的抛射物。请勿近距离射击。
警告: 目や顔を狙わないでください。このおもちゃに同梱されている発射物のみ使用するようにしてください。到達可能な距離内で火を燃やさないでください。
تحذير: يجب عدم التصويب باتجاه العينين أو الوجه. يجب استخدام المقذوفات المزودة مع هذه اللعبة فقط. يجب عدم الإطلاق من مدى قريب.



























14x AM79425E	4x AM76659E	1x AS-FVK76-18	8x MA17201JF	2x MA03019JF	1x AM79679BYE	4x MA18328HT
2x MA17003NV	2x AM76659BLG	2x AS-FVK76-01	2x MA07629JF	1x AS-FVK76-07	2x AM78285BYE	4x AM74060JF
2x AM78219HT	2x AM79570NV	2x AS-FVK76-02	2x MA18740JF	10x MA09013JF	4x AM78285JF	2x AM78282BYE
4x AM76558JF	2x AM78296BYE	1x AM78382HT	2x MA72002JF	3x MA18665JF	1x AM78285ASX	2x MA76525JF
8x MA03328JF	4x AM78296NV	2x AM78280HT	2x MA15481JF	7x MA18665HT	1x MA0948AMC	2x MA74106JF
2x MA19392NV	6x AM78289RQ	1x MA022501JF	6x MA15481RQ	3x MA18666JF	7x MA0948JF	1x MA74106ASX
1x M19392W	8x AM18240HQ	1x MA022501ASX	2x MA15480JF	7x MA18666HT	1x AM73009BDG	1x MA10273JF
4x MA74415JF	2x AM79432WH	26x MA09393JF	6x MA15480RQ	2x MA16972JF	1x AM73009HT	2x AM74671JF
2x MA12251JF	1x AM79432BYE	1x MA09393AMC	1x MA74427JF	4x MA16972HQ	12x MA03773JF	2x AM74672JF
10x AM77574JF	2x AM79487BYE	2x MA09393HT	1x MA74426JF	10x MA15484JF	6x MA03773RQ	1x MA09023JF
5x AM74299HT	1x MA0910MY	8x MA16680JF	2x AS-FVK76-21	2x AM04320JF	3x MA03773BYE	2x AM74672JF
5x AM74300HT	2x AM79403NV	4x MA72000HT	4x MA17128JF	2x AM04321JF	4x MA03773HT	1x MA09023JF
2x AM19530JF	2x AM79403HT	2x MA72000JF	2x MA04429JF	1x AM76206JF	4x MA03773HT	2x MA72233NV
2x MA74397NV	2x MA74645NV	12x MA76467JF	8x MA17788JF	2x AM04320JF	2x MA03773AMC	2x MA1314HT
1x M74397W	1x AM78281BYE	4x AM78276JF	2x MA1322JF	12x AM76206HT	6x MA1146JF	2x MA1314JF
2x AM78600HT	5x AM78281JF	1x AM78397JF	12x MA17131JF	1x AM76205JF	2x AM74314ASX	2x MA1314ASX
6x MA17127JF	1x AM78400BDG	6x AM78277RQ	2x MA16679JF	12x AM76205HT		

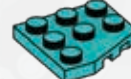









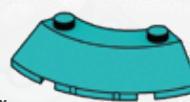

- 4x AM78286JF 
- 4x AM78398BYE 
- 2x AM78386HT 
- 2x AM78601HT 
- 4x AM79227JF 
- 4x AM79111JF 
- 1x AM79561RD 
- 1x AM79586RD 
- 3x AS-FVK76-10 
- 3x AS-FVK76-13 
- 2x MA17074JF 
- 3x AS-FVK76-11 
- 3x AS-FVK76-14 
- 2x MA17073JF 
- 2x AM78599HT 

- 4x AM16653HT 
- 6x AM16653RQ 
- 2x AM17016BLG 
- 1x AS-FVK76-04 
- 1x AS-FVK76-03 
- 2x AM72240RD 
- 13x MA03772JF 
- 4x MA03772HT 
- 3x AS-FVK76-15 
- 3x AS-FVK76-12 
- 7x MA09593JF 
- 6x MA09593HT 
- 6x MA09593RQ 

- 2x MA08481JF 
- 4x MA07230JF 
- 4x AM17021JF 
- 2x AS-FVK76-16 
- 2x AS-FVK76-17 
- 12x AM18657JF 
- 2x AM18736JF 
- 1x AS-FVK76-08 
- 1x AS-FVK76-09 
- 2x AS-FVK76-22 
- 4x MA16384JF 
- 2x MA03873JF 
- 2x MA1087JF 

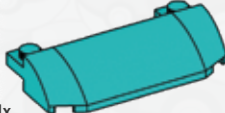
- 2x AM76367HT 
- 1x AM16640RD 
- 6x AM19324JF 
- 3x AM18282JF 
- 3x AM18283JF 
- 1x AM03323JF 
- 1x AM03324JF 
- 8x MA09493JF 
- 10x MA09493HT 
- 5x MA09033JF 
- 2x AM18613JF 
- 2x AM18612JF 

- 4x AM16638JF 
- 1x AS-FVK76-06 
- 1x AS-FVK76-05 
- 6x MA07475JF 
- 1x MA09292JF 
- 1x MA1480JF 
- 1x MA1313JF 
- 2x MA04983JF 
- 3x AM18656JF 
- 1x AM19011JF 
- 1x AM18259W 
- 1x AM18259HT 



1x AS-FVK26-24



2x MA08483JF

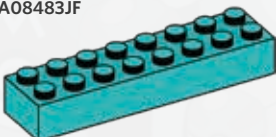

1x MA04984JF



1x AM79020BDG



1x AM79019MCX



2x AS-FVK76-23



2x AM76192HT



1x AS-FVK76-20



1x AS-FVK76-19



1x AM79592MCX

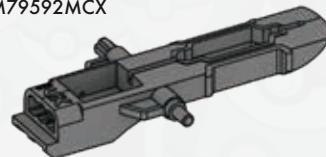

1x AM79591BDG

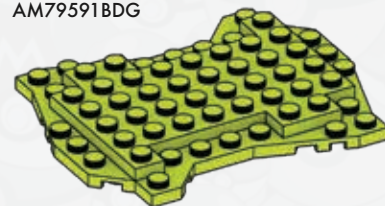

1x MA18845BBG

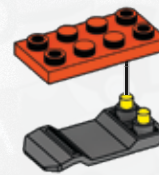

1



2

- ⚠ WARNING :
CHOKING HAZARD. - Small parts.
Not for children under 3 years.
 - ⚠ ATTENTION :
DANGER D'ÉTOUFFEMENT. - Présence de petits éléments.
Ne convient pas aux enfants de moins de 3 ans.
 - ⚠ 警告:
噎住危險。包含有小部件
不适合3岁以下的小孩玩。
 - ⚠ 警告:
のどにつまる危険 小さな部品が含まれています
3歳以下の子供には与えないで下さい。
- ⚠ : تحذير
خطر الاختناق - قطع صغيرة.
غير صالحة للأطفال أقل من 3 سنوات.

- ADVERTENCIA: Peligro de asfixia. Juguete no recomendado para menores de 3 años, porque contiene piezas pequeñas que podrían provocar asfixia en casode ser ingeridas o inhaladas por el/la niño/a.
- ATENÇÃO: Não recomendável para crianças com menos de 36 meses. Contém peças pequenas capazes de criar risco de asfixia.
- AVVERTENZA: Contiene pezzi di piccole dimensioni.
- ACHTUNG: Kleine Teile.
- OSTRZEŻENIE: Małe części
- WAARSCHUWING: Kleine onderdelen
- ПРЕДУПРЕЖДЕНИЕ: Мелкие детали
- ADVARSEL: Små dele.
- VARNING: Smådelar
- ADVARSEL: Små deler.
- VAROITUS: Pieniä osia
- ΠΡΟΣΟΧΗ: Περιλαμβάνονται μικρά κομμάτια.
- UYARI: BOĞULMA TEHLİKESİ - Küçük Parçalar İçerir. 3 yaşından küçük çocuklar için uygun değildir.



Please read these instructions carefully before first use and keep them for future reference.
Il est recommandé de lire attentivement ce feuillet avant la première utilisation et de le conserver pour référence future.
Leer estas instrucciones cuidadosamente antes de la primera utilización y guardarlas para referencia futura.
Leia as instruções antes do primeiro uso e guarde-as para futura referência.
Leggere le istruzioni prima di cominciare ad usare il gioco e conservarle per referenze future.
Die Gebrauchsanleitung bitte durchlesen und aufbewahren.
Proszę uważnie przeczytać instrukcję obsługi przed pierwszym użyciem, a następnie zachować ją na przyszłość.
Wij raden u aan deze handleiding zorgvuldig te lezen en te bewaren voor eventuele raadpleging op een later tijdstip.
Внимательно прочитайте инструкцию перед первым использованием и сохраните ее для дальнейшего использования.
Vær venlig at læse disse instruktioner omhyggeligt inden ibrugtagen og opbevar dem til fremtidigt brug.
Läs noggrant igenom dessa instruktioner innan du använder produkten för första gången och spara dem för ev. framtida frågor.
Les disse instruksjonene nøye før første gangs bruk, og ta vare på dem for fremtidige oppslag.
Lue nämä ohjeet huolellisesti ennen ensimmäistä käyttööä ja säilytä ne myöhempää tarvetta varten.
Διαβάστε προσεκτικά τις οδηγίες πριν από τη χρήση και κρατήστε τις για μελλοντική αναφορά.
İlk kullanımdan önce talimatları dikkatlice okumanızı ve bu bilgileri ileride tekrar bakabilmek için saklamanızı öneririz.
第一次使用前，請仔細閱讀本說明書并保留以備將來參考。
初めてご使用になる前に、この説明書をよくお読みください。また、本書は将来いつでも参照できるように保管してください。
يجب قراءة هذه التعليمات بعناية قبل الاستخدام والاحتفاظ بها للعودة إليها مستقبلاً.

Ⓟ D781,964 D797,203
Patents pending.
Brevets en instance.



**MEGA
CONSTRUX™**

POKÉMON™



FVK69



FVK68



FVK67



FVK81



FVK70



FVK75



FVK77

Each sold separately and subject to availability. / Produits vendus séparément, selon la disponibilité. / Se venden por separado y están sujetos a disponibilidad. / Vendidos em separado e sujeitos à disponibilidade. / Ognuno in vendita separatamente secondo disponibilità. / Alle Artikel separat erhältlich. Einige Artikel werden nicht in allen Ländern vertrieben. / Sprzedawane oddzielnie w zależności od dostępności. / Per stuk verkrijgbaar en niet overal leverbaar. / Каждый продукт продается отдельно, в зависимости от наличия. / Sælges separat og så længe lager haves. / Alla delar säljs separat så långt lagret räcker. / Hver leke selges separat så langt lageret rekker. / Jokainen myydään erikseen, saatavuus voi vaihdella. / Το καθένα πωλείται ξεχωριστά και ανάλογα με τη διαθεσιμότητα. / Her biri ayrı ayrı ve stoklara bağlı olarak satılır. / 每件单独出售，并且视库存情况而定。 / それぞれ在庫状況に従って個別に販売されます。 / تباع كل منها على حدة وتخضع لتوفرها.

©2017, MEGA Brands Inc. &™ MEGA Brands Inc. CONSTRUX™ is owned by Mattel and used under license. CONSTRUX™ appartient à Mattel et est utilisée sous licence. Printed in Canada D-FVK76-02A

