

DC SUPER FRIENDS

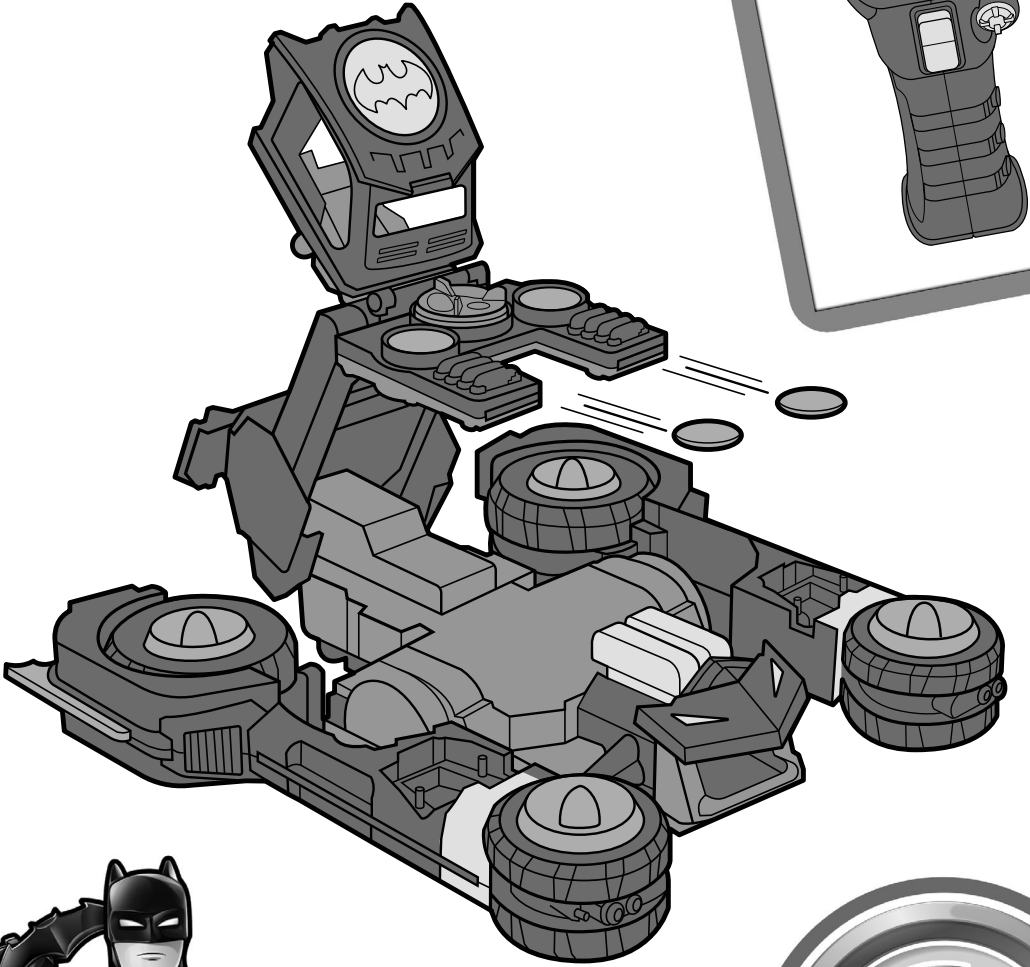

imaginext[®]
GBK77



TM

BEFORE YOU BEGIN



Keep these instructions for future reference as they contain important information.

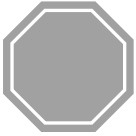

Play Safely! Do not drive the vehicle in the street!

We do not recommend using the vehicle on carpets, loose dirt or wet surfaces. For best performance, use indoors on hard, flat surfaces.



Frequency: 2420MHz-2465MHz

Max. EIRP: 3.8dBm (for Europe)

Operating multiple vehicles with the same frequency in close proximity will cause interference and poor performance. Works best away from high voltage power lines, large buildings and walls.

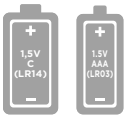

x 4 x 2

Batmobile™ includes four C batteries. Batteries included are for demonstration purposes only. We recommend replacing these batteries when you install batteries in the remote control.

Remote control requires two AAA batteries (not included).

You'll need a Phillips screwdriver (not included) to install batteries. Only adults should install batteries.



Clean with a damp cloth. Do not immerse.

If the remote control or vehicle are accidentally dropped in the water, remove the batteries and discard. Allow the remote control and vehicle to air dry. Then, install new batteries.

This toy has no consumer serviceable parts. Do not take apart.



Disks only launch when the vehicle is transforming up to **Battle Mode**.

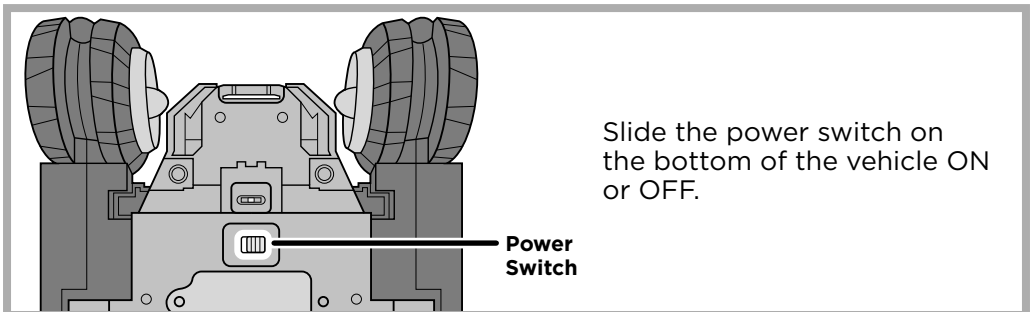

Slide the power switch on the bottom of the vehicle ON or OFF.

Power Switch

INSTALL BATTERIES

Loosen the screws in the battery doors.

Remove exhausted batteries in the vehicle and properly discard.

Insert four, new C (LR14) **alkaline** batteries in the vehicle and two, new AAA (LR03) **alkaline** batteries in the remote control. For longer life, use **alkaline** batteries.

Replace the battery doors and tighten the screws. Do not over-tighten the screws.

You may need to reset the electronics if the vehicle or the remote control begin to operate erratically. Slide the power switch on the vehicle off and back on. Remove and reinstall the batteries in the remote control.

When the vehicle slows, stops or doesn't respond to the remote control or sounds or lights become faint or stop, it is time for an adult to change the batteries.

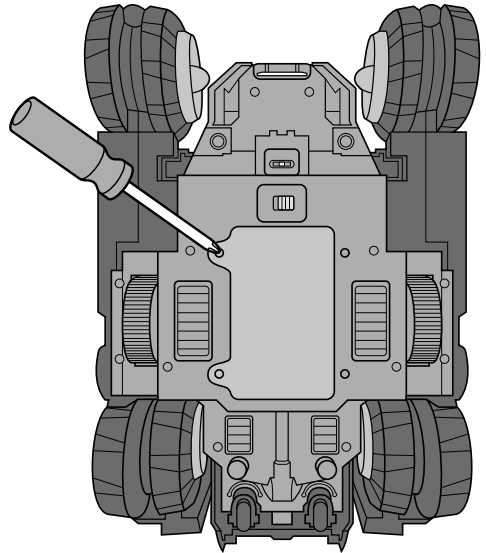
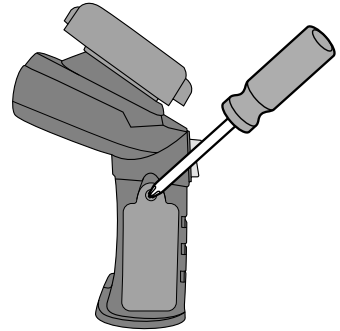

Battery Safety Information

In exceptional circumstances, batteries may leak fluids that can cause a chemical burn injury or ruin your product. To avoid battery leakage:

Do not mix old and new batteries or batteries of different types: alkaline, standard (carbon-zinc) or rechargeable.

Insert batteries as indicated inside the battery compartment (+ and -).

Remove batteries during long periods of non-use. Always remove exhausted batteries from the product. Dispose of batteries safely. Do not dispose of this product in a fire. The batteries inside may explode or leak.

Never short-circuit the battery terminals.

Use only batteries of the same or equivalent type, as recommended.

Do not charge non-rechargeable batteries.

Remove rechargeable batteries from the product before charging.

If removable, rechargeable batteries are used, they are only to be charged under adult supervision.

TRANSFORM ON THE GO!

⚠ CAUTION

To prevent entanglement, keep hair away from wheels.

Turn the Power Pad or press the button on the remote control to transform Batmobile™ up into **Battle Mode** or back down to **Street Mode**.

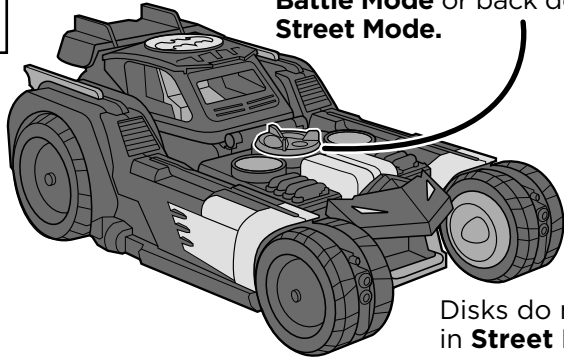

Disks do not fire in **Street Mode**.

Batmobile™ fires disks only when transforming to **Battle Mode**.

Load disks here.

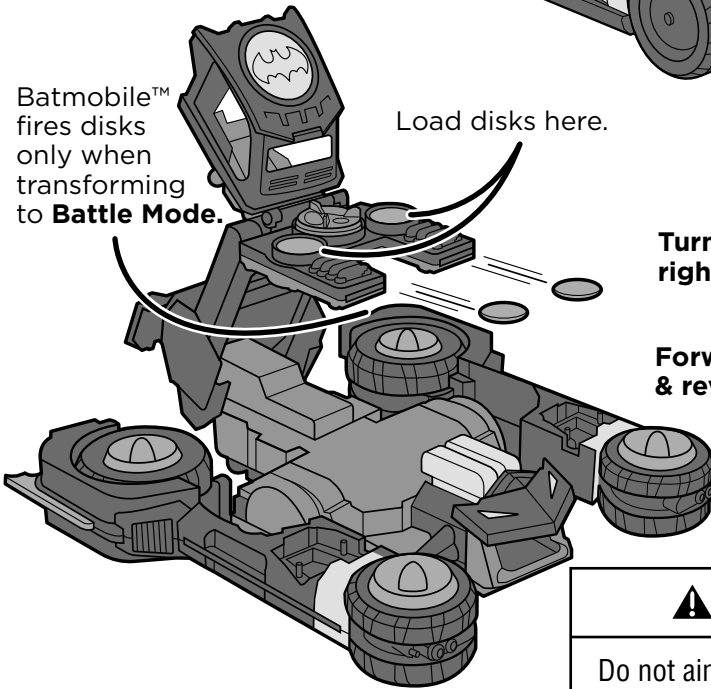

Cool sounds

Turn right

Turn left

Forward & reverse

Transform

⚠ WARNING:

Do not aim at eyes or face. Only use projectiles supplied with this toy. Do not fire at point blank range.

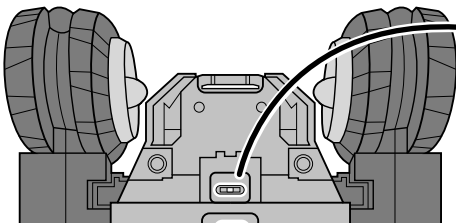

If the vehicle does not move forward or backward in a straight line, you may want to adjust wheel alignment. Slide the **front end alignment** switch to either the right or left.

GENERAL INFORMATION

FCC STATEMENT (UNITED STATES ONLY)

This equipment has been tested and found to comply with the limits for a Class B digital device, pursuant to Part 15 of the FCC rules. These limits are designed to provide reasonable protection against harmful interference in a residential installation. This equipment generates uses and can radiate radio frequency energy and, if not installed and used in accordance with the instructions, may cause harmful interference to radio communications. However, there is no guarantee that interference will not occur in a particular installation. If this equipment does cause harmful interference to radio or television reception, which can be determined by turning the equipment off and on, the user is encouraged to try to correct the interference by one or more of the following measures:

- Reorient or relocate the receiving antenna.
- Increase the separation between the equipment and receiver.
- Consult the dealer or an experienced radio/TV technician for help.

NOTE: Changes or modifications not expressly approved by the manufacturer responsible for compliance could void the user's authority to operate the equipment. This device complies with Part 15 of the FCC Rules. Operation is subject to the following two conditions: (1) This device may not cause harmful interference, and (2) this device must accept any interference received, including interference that may cause undesired operation.

CAN ICES-3 (B)/NMB-3 (B)

This device contains licence-exempt transmitter(s)/receiver(s) that comply with Innovation, Science and Economic Development Canada's licence-exempt RSS(s). Operation is subject to the following two conditions: (1) This device may not cause interference. (2) This device must accept any interference, including interference that may cause undesired operation of the device.

L'émetteur/récepteur exempt de licence contenu dans le présent appareil est conforme aux CNR d'Innovation, Sciences et Développement économique Canada applicables aux appareils radio exempts de licence. L'exploitation est autorisée aux deux conditions suivantes : (1) L'appareil ne doit pas produire de brouillage; (2) L'appareil doit accepter tout brouillage radioélectrique subi, même si le brouillage est susceptible d'en compromettre le fonctionnement



Protect the environment by not disposing of this product or any batteries with household waste. This symbol indicates that this product shall not be treated as household waste. Check your local authority for recycling advice and facilities.





UNITED STATES: 1-800-432-5437.
Fisher-Price, Inc., 636 Girard Avenue,
East Aurora, NY 14052.

GREAT BRITAIN: Mattel UK Ltd, Vanwall
Business Park, Maidenhead SL6 4UB. Helpline:
01628 500303; www.service.mattel.com/uk.

Mattel Europa B.V., Gondel 1, 1186 MJ
Amstelveen, Nederland.

CANADA: 1-800-432-5437. Mattel Canada Inc.,
6155 Freemont Blvd., Mississauga, Ontario
L5R 3W2.

AUSTRALIA: Mattel Australia Pty. Ltd., 658
Church Street, Locked Bag #870, Richmond,
Victoria 3121 Australia. Consumer Advisory
Service 1300 135 312.

NEW ZEALAND: 16-18 William Pickering Drive,
Albany 1331, Auckland.

ASIA: Mattel East Asia Ltd., Room 503-09,
North Tower, World Finance Centre,
Harbour City, Tsimshatsui, HK, China.
Tel.: (852) 3185-6500.

MALAYSIA: Diimport & Diedarkan Oleh:
Mattel Southeast Asia Pte. Ltd., No 19-1,
Tower 3 Avenue 7, Bangsar South City, No 8,
Jalan Kerinchi, 59200 Kuala Lumpur, Malaysia.
Tel: 03-33419052.

SOUTH AFRICA: Mattel South Africa (PTY)
LTD, Office 102 I3, 30 Melrose Boulevard,
Johannesburg 2196.



DC SUPER FRIENDS and all related characters and
elements © & ™ DC Comics.
WB SHIELD: TM & © WBEI.
(s19)