

HOT WHEELS

TRACK BUILDER UNLIMITED™



BUILD & REBUILD

YOUR TRACK BUILDER SYSTEM™



Colors and decorations may vary.
Los colores y las decoraciones pueden variar.
Les couleurs et les motifs peuvent varier.
As cores e as decorações podem variar.

6-12



HOTWHEELS.COM

Please keep these instructions for future reference as they contain important information.
Lee y guarda estas instrucciones para futura referencia, ya que contienen información importante acerca de este producto.
Conserver le présent mode d'emploi pour s'y référer en cas de besoin, car il contient des renseignements importants.
Por favor, guarde estas instruções para futura referência, pois contém informações importantes.

**INSTRUCTIONS · INSTRUCCIONES
MODE D'EMPLOI · INSTRUÇÕES**

GLC95-4B70
1102208456-4LB

**1 WELCOME TO TRACK BUILDER! • ¡BIENVENIDO A TRACK BUILDER!
BIENVENUE À TRACK BUILDER! • BEM-VINDO A TRACK BUILDER!**

CHOOSE ONE TO BUILD FIRST! • ¡ESCOGE LA QUE QUIERAS CONSTRUIR PRIMERO!
CHOISIS D'ABORD UNE CONFIGURATION! • ESCOLHA UM PARA MONTAR PRIMEIRO!

MODE • MODO 1

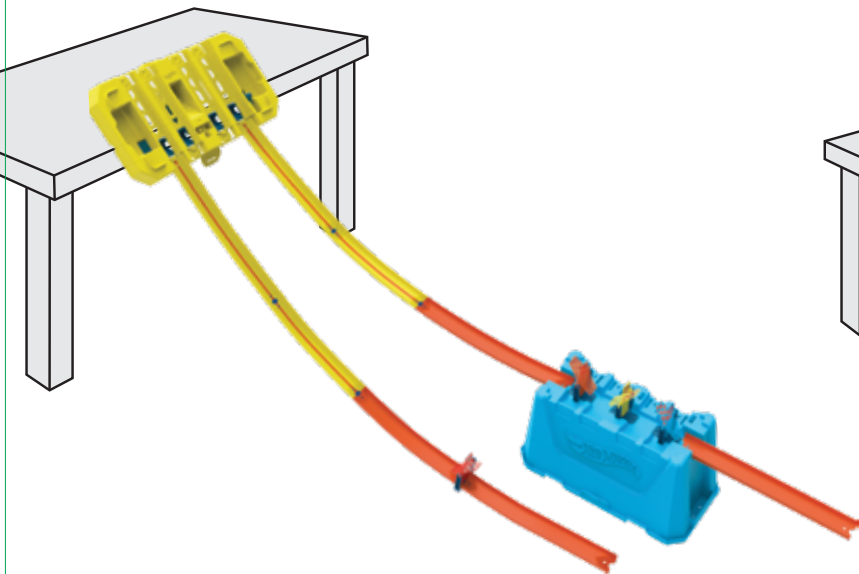

MODE • MODO 2

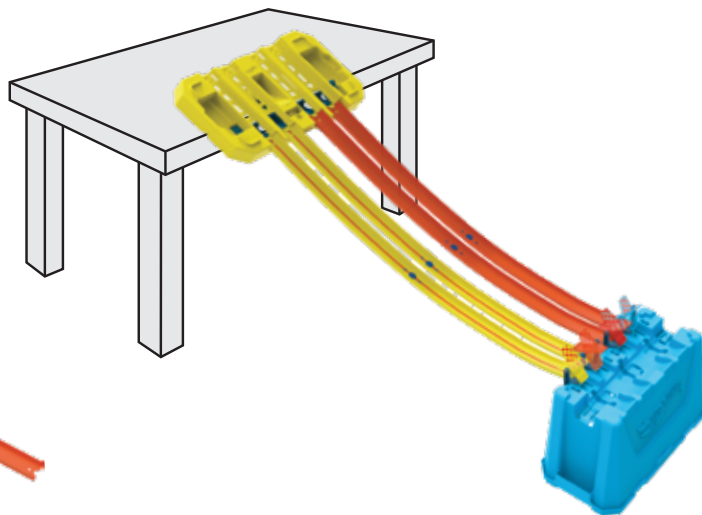

HERE'S WHAT YOU GET! • INCLUYE,
VOICI LE CONTENU! • ITENS INCLUIDOS

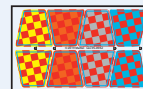
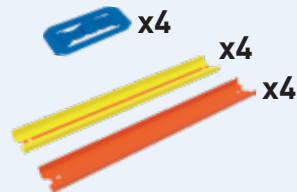
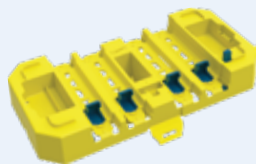

2 BUILD BASIC PARTS • CONSTRUYE PARTES BÁSICAS ASSEMBLE CES ÉLÉMENTS DE BASE • MONTE AS PARTES BÁSICAS

1 APPLY LABELS ON BOTH SIDES. • UBICA LAS ETIQUETAS EN AMBOS COSTADOS.
APPOSE LES ÉTIQUETTES SUR LES DEUX CÔTÉS. • COLOQUE AS ETIQUETAS EM AMBOS OS LADOS.

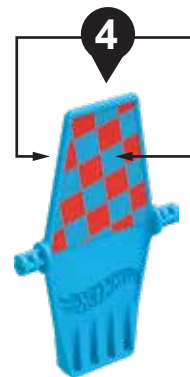
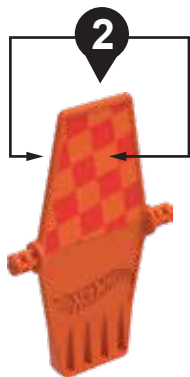
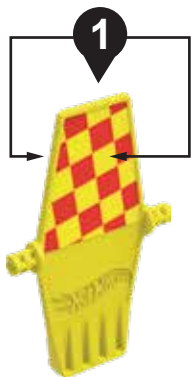

3 BUILD (MODE 1) • CONSTRUYE (MODO 1) CONFIGURATION (MODE 1) • MONTAGEM (MODO 1)

1 SNAP ANY THREE FLAGS INTO SLOTS. • COLOCA CUALQUIERA DE LAS TRES BANDERAS EN LAS RANURAS. • ENCLENCHE TROIS DRAPEAUX DANS LES FENTES. • ENCAIXE QUALQUER UMA DAS TRÊS BANDEIRAS NO ESPAÇO.

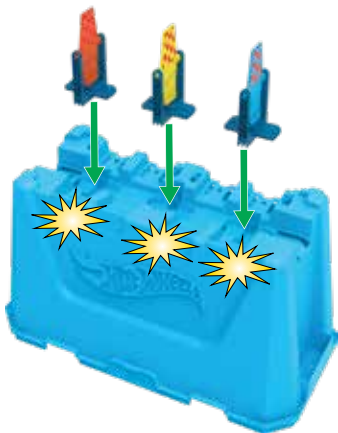

2 **A** ATTACH TO THE EDGE OF A TABLE. • AJÚSTALA AL BORDE DE UNA MESA. • FIXE AU BORD DE LA TABLE. • CONECTE NA BEIRA DE UMA MESA.

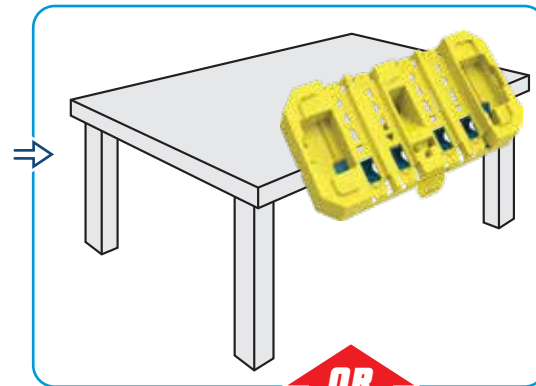
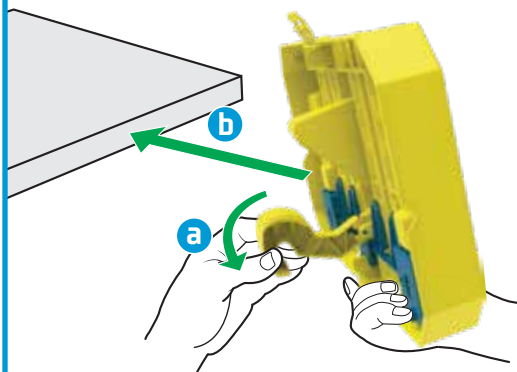

OR
OU

B HANG ON THE BACK OF A CHAIR. • CUÉLGALA EN LA PARTE TRASERA DE UNA SILLA. • ACCROCHE AU DOSSIER D'UNE CHAISE. • PENDURE NO ENCOSTO DE UMA CADEIRA.

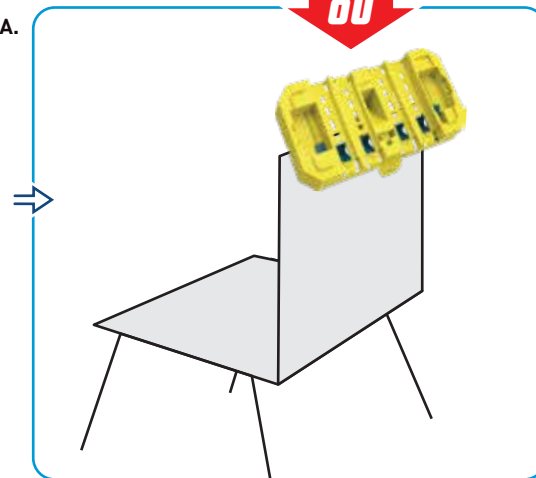
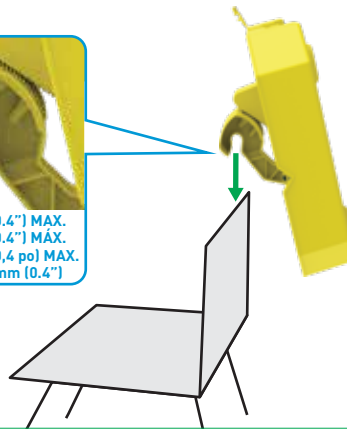

3

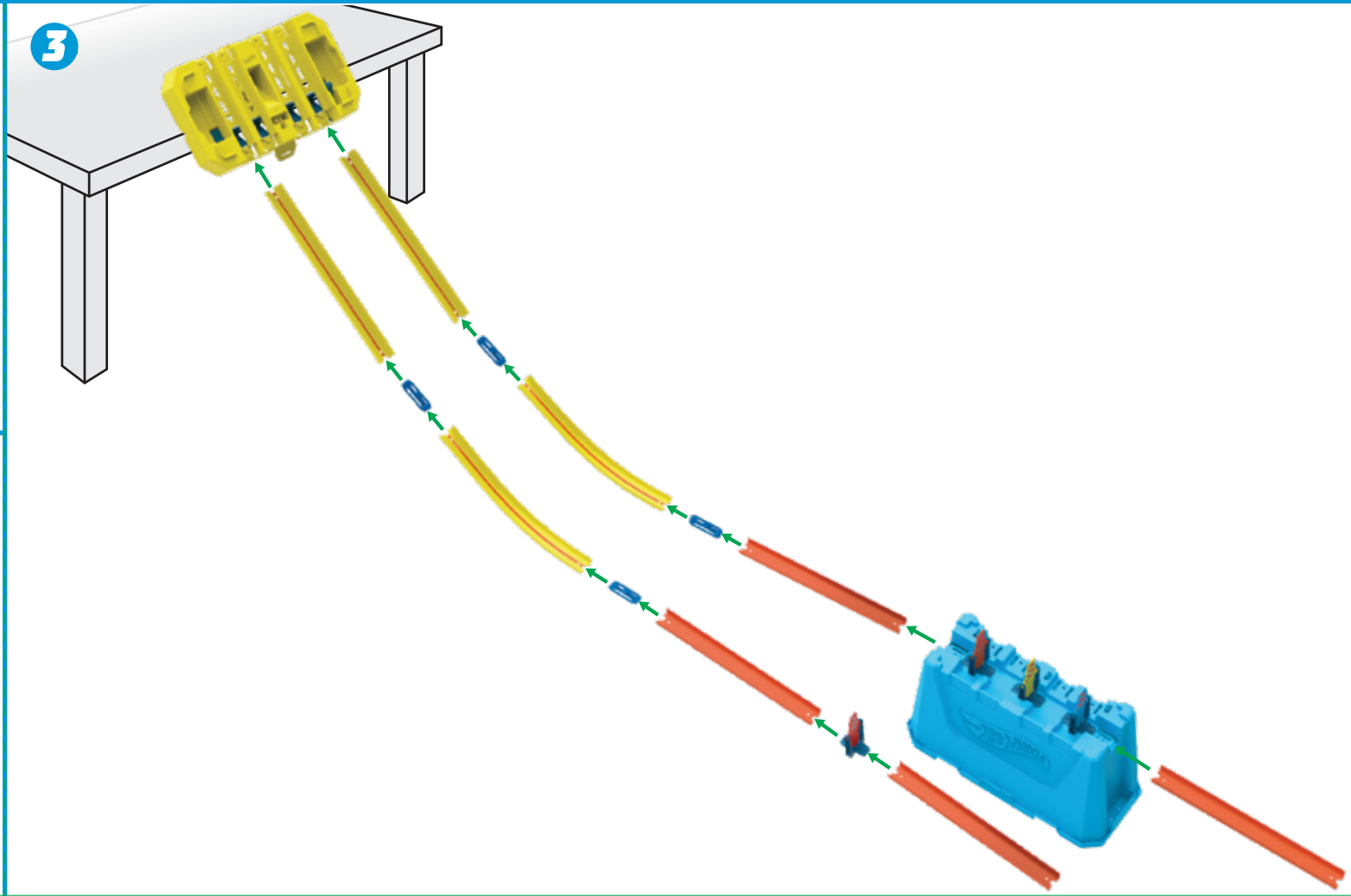

4

**TO RACE (MODE 1) • PARA LA CARRERA (MODO 1)
POUR FAIRE LA COURSE (MODE 1) • PARA COMPETIR (MODO 1)**

a LOCK THE GATES.
CIERRA LAS PUERTAS.
VERROUILLE LES
BARRIÈRES.
TRAVE OS PORTÕES

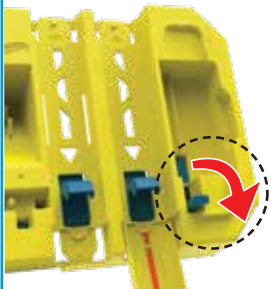

b

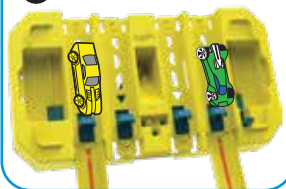

c LOWER GATES TO LAUNCH!
¡BAJA LAS PUERTAS PARA COMENZAR!
ABAISSÉ LES BARRIÈRES POUR LANCER!
ABAIXE OS PORTÕES PARA LANÇAR!

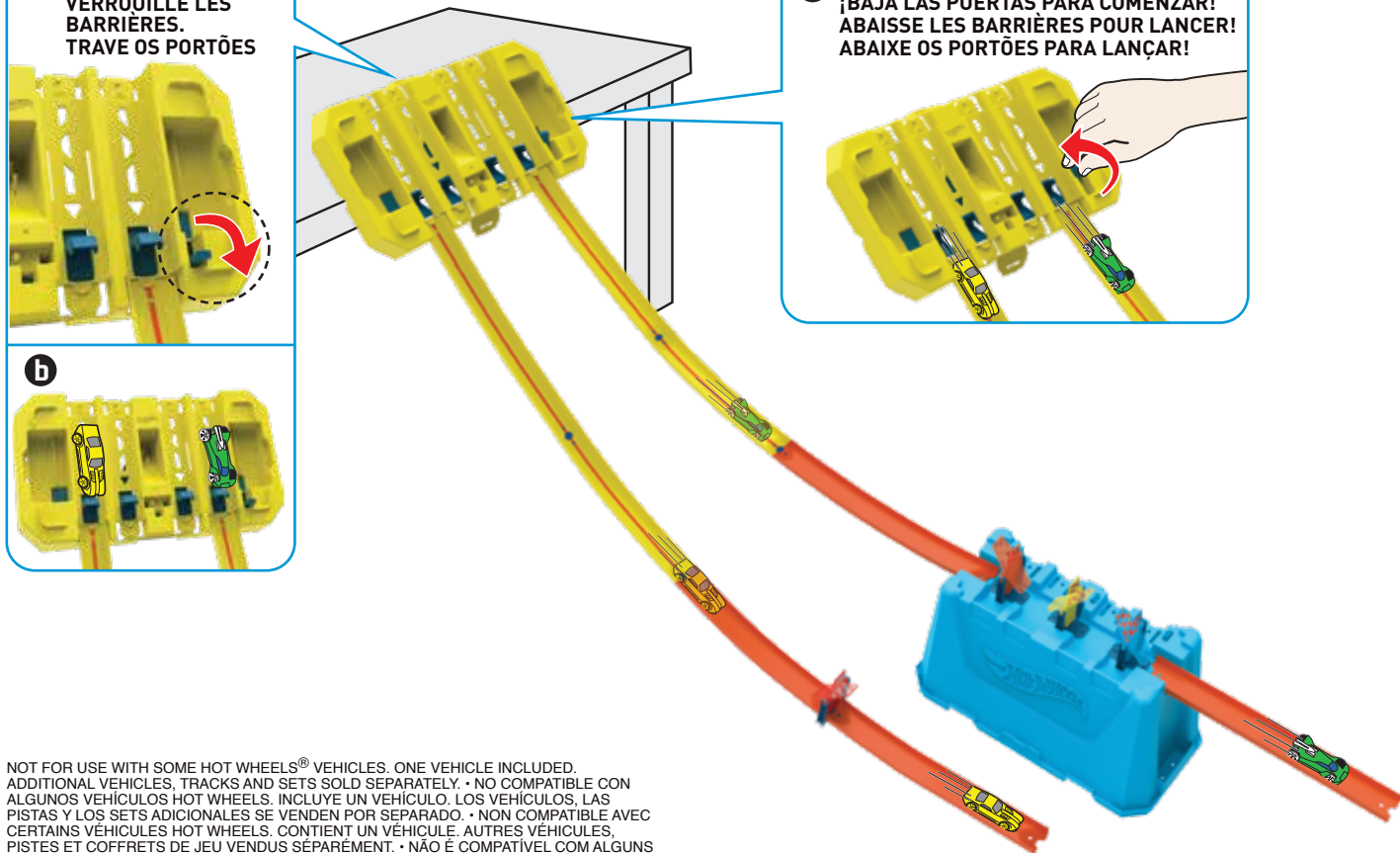
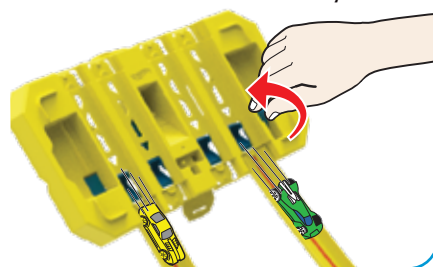

NOT FOR USE WITH SOME HOT WHEELS® VEHICLES. ONE VEHICLE INCLUDED.
ADDITIONAL VEHICLES, TRACKS AND SETS SOLD SEPARATELY. • NO COMPATIBLE CON
ALGUNOS VEHÍCULOS HOT WHEELS. INCLUYE UN VEHÍCULO. LOS VEHÍCULOS, LAS
PISTAS Y LOS SETS ADICIONALES SE VENDEN POR SEPARADO. • NON COMPATIBLE AVEC
CERTAINS VÉHICULES HOT WHEELS. CONTIENT UN VÉHICULE. AUTRES VEHÍCULES,
PISTES ET COFFRETS DE JEU VENDUS SÉPARÈMENT. • NÃO É COMPATÍVEL COM ALGUNS
VEÍCULOS HOT WHEELS. UM VEÍCULO INCLUIDO. VEÍCULOS, PISTAS E CONJUNTO
ADICIONAIS SÃO VENDIDOS SEPARADAMENTE.

5 BUILD (MODE 2) • CONSTRUYE (MODO 2)
CONFIGURATION (MODE 2) • MONTAGEM (MODO 2)

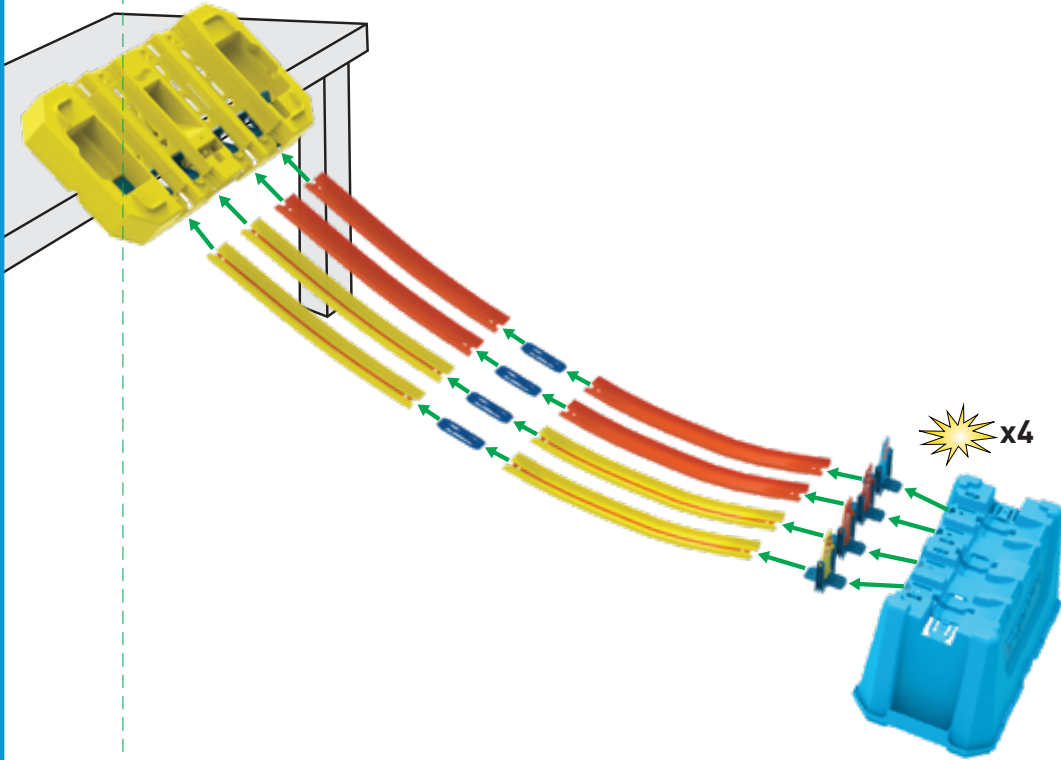

6 TO RACE (MODE 2) • PARA LA CARRERA (MODO 2)
POUR FAIRE LA COURSE (MODE 2) • PARA COMPETIR (MODO 2)

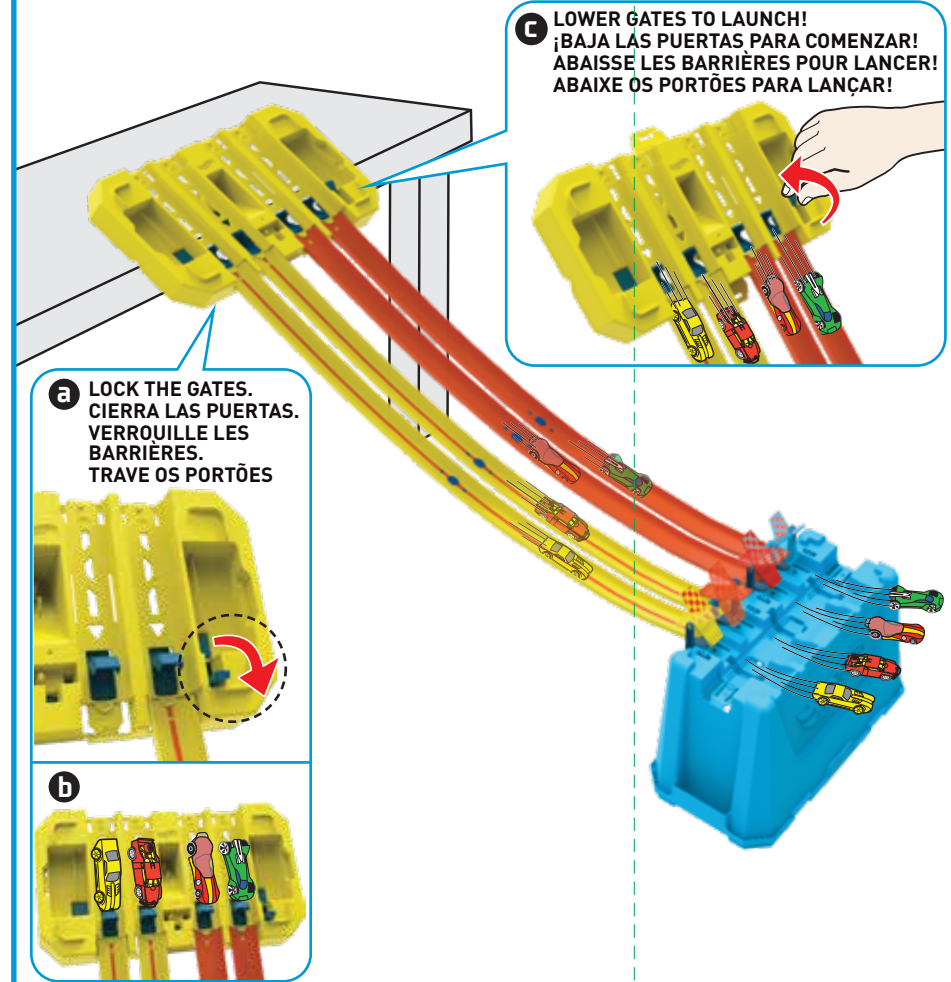

7

MORE WAYS TO PLAY • MÁS MANERAS DE JUGAR AUTRES FAÇONS DE JOUER • OUTRAS MANEIRAS DE BRINCAR

**CUSTOMIZE TRACK AND RACE WITH MONSTER TRUCKS & TRACK STAR HAULERS! •
PERSONALIZA LA PISTA Y DISFRUTA DE UNA CARRERA CON LOS TRANSPORTADORES
DE MONSTER TRUCKS & TRACK STAR! • PERSONNALISE LA PISTE ET LES COURSES
AVEC DES VÉHICULES MONSTER TRUCKS ET CAMIONS TRACK STARS! • CUSTOMIZE A
PISTA E A CORRIDA COM MONSTER TRUCKS E TRANSPORTADORES TRACK STAR!**

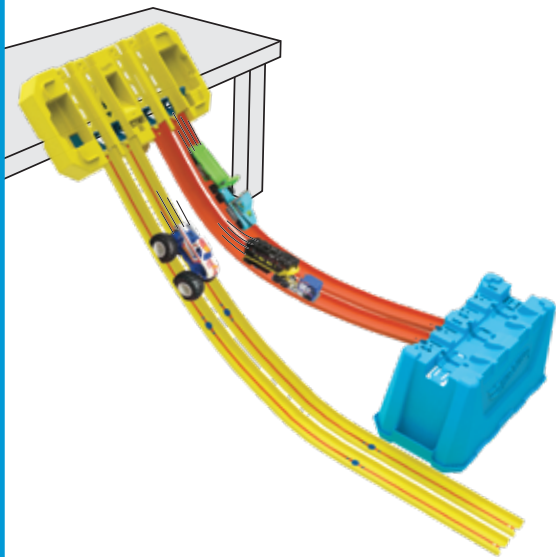

NOT FOR USE WITH SOME HOT WHEELS® VEHICLES. ONE VEHICLE INCLUDED.
ADDITIONAL VEHICLES, TRACKS AND SETS SOLD SEPARATELY. • NO COMPATIBLE COM
ALGUNOS VEHÍCULOS HOT WHEELS. INCLUYE UN VEHÍCULO. LOS VEHÍCULOS, LAS
PISTAS Y LOS SETS ADICIONALES SE VENDEN POR SEPARADO. • NON COMPATIBLE AVEC
CERTAINS VEHÍCULES HOT WHEELS. CONTIENT UN VÉHICULE. AUTRES VÉHICULES,
PISTES ET COFFRETS DE JEU VENDUS SÉPARÉMENT. • NÃO É COMPATÍVEL COM ALGUNS
VEÍCULOS HOT WHEELS. UM VEÍCULO INCLUIDO. VEÍCULOS, PISTAS E CONJUNTO
ADICIONAIS SÃO VENDIDOS SEPARADAMENTE.



GLC88



GLC89



GLC90



GLC91



GLC92



GLC93



GLC94

**ADVERTISEMENT
AVISO
PUBLICITÉ
PUBLICIDADE**

©2019 Mattel, Mattel, Inc., 636 Girard Avenue, East Aurora, NY 14052, U.S.A. Consumer Services 1-800-524-8697. Mattel Canada Inc., Mississauga, Ontario L5R 3W2. You may call us free at / Composez sans frais le 1-800-524-8697. Mattel Australia Pty. Ltd., 658 Church St., Richmond, Victoria, 3121. Consumer Advisory Service - 1300 135 312. Mattel East Asia Ltd., Room 503-09, North Tower, World Finance Centre, Harbour City, Tsinghsu, HK, China. Tel.: (852) 3185-6500. Diimport & Diedarkan Oleh: Mattel Southeast Asia Pte. Ltd., No 19-1, Tower 3 Avenue 7, Bangsar South City, No 8, Jalan Kerinci, 59200 Kuala Lumpur, Malaysia. Tel: 03-33419052. Mattel U.K. Ltd., Vanwall Business Park, Maidenhead SL6 4UB. Importado y distribuido por Mattel de México, S.A. de C.V., Miguel de Cervantes Saavedra No. 193, Pisos 10 y 11, Col. Granada, Alcaldía Miguel Hidalgo, C.P. 11520, México, Ciudad de México. R.F.C. MME-920701-NB3. Tels: 59-05-51-00 Ext. 5206 o 01-800-463-59-89. Mattel Chile, S.A., Avenida América Vespucio 501-B, Quilicura, Santiago. Tel.: 1230-020-6213. Servicio al consumidor Venezuela: Tel.: 0-800-100-9123. Mattel Argentina, S.A., Av. Libertador 1000, Piso 11 – Oficinas 109 y 111, Vicente López – Prov. Buenos Aires. Tel.: 0800-666-3373. Mattel Colombia, S.A., Calle 12347-07 P.5, Bogotá. Tel.: 01800-710-2069. Mattel Perú, S.A., Av. Juan de Arona # 151, Centro Empresarial Juan de Arona, Torre C, Piso 7, Oficina 704, San Isidro, Lima 27, Perú. RUC: 20425853865. Reg. Importador: 02350-12-JUE-DIGESA. Tel.: 0800-54744. E-mail Latinoamérica: Servicio.Clientes@Mattel.com. Distribuido por: Mattel do Brasil Ltda. - CNPJ - 54.558.002/0001-20 - Rua Verbo Divino, 1488 - 2º - Andar - 04719-904 - Chácara Santo Antônio - São Paulo - SP - Brasil. Serviço de Atendimento ao Consumidor: fone 0800-550780. E-mail: sac@mattel.com. Mattel France, Parc de la Cerisaie, 1/3/5 allée des Fleurs, 94260 Fresnes Cedex. N° Cristal 0969 36 99 99 (Numéro non surtaxé) ou www.lesjouetsmattel.fr. Mattel España, S.A., Aribau 200. 08036 Barcelona. c.service.spain@mattel.com. Tel: 902203010 http://www.service.mattel.com/es. Mattel South Africa (PTY) LTD, Office 102 B, 30 Melrose Boulevard, Johannesburg 2196.



service.mattel.com