

Barbie

INSTRUCTIONS • INSTRUCCIONES MODE D'EMPLOI • INSTRUÇÕES

3+



GMW07

CONTENTS • CONTENIDO • CONTENU • CONTEÚDO

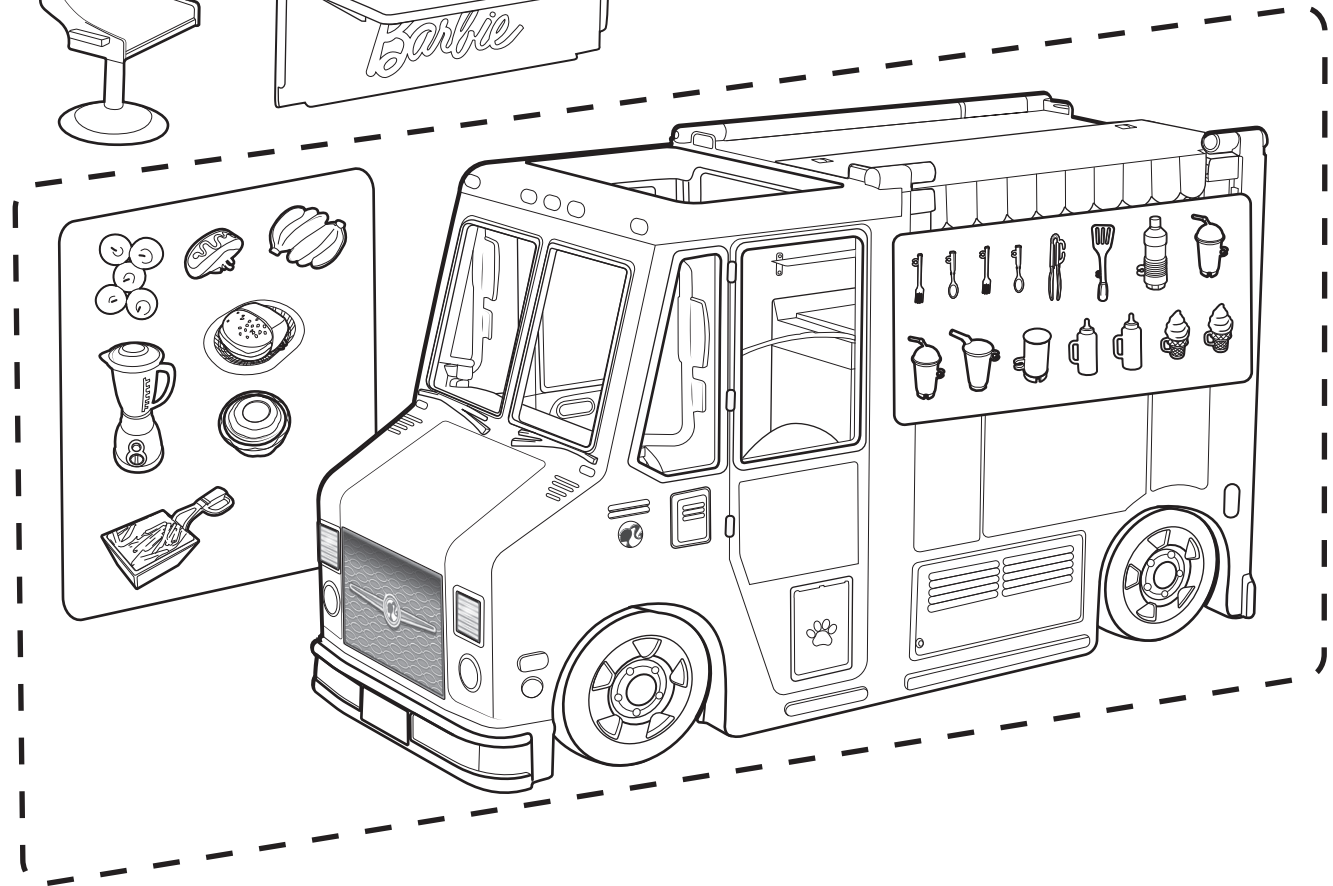
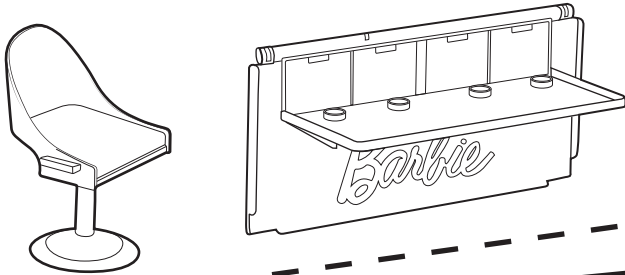
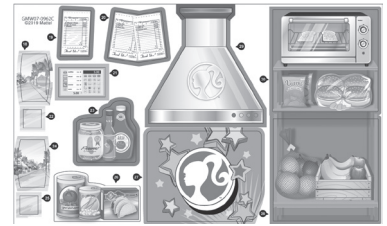
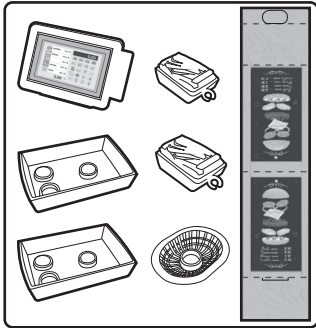

Please remove everything from the package and compare to the contents shown here. If any items are missing, please contact your local Mattel office. Keep these instructions for future reference as they contain important information.

Sacar todo del empaque y comparar las piezas con el contenido mostrado aquí. Si falta alguna pieza, contactar a la oficina Mattel más próxima a su localidad. Visite <http://service.mattel.com/intl/es.asp> para un listado completo. Leer y guardar estas instrucciones para futura referencia, ya que contienen información importante acerca del producto.

Retirer tous les éléments de l'emballage et les comparer au contenu illustré. S'il manque des éléments, communiquer avec le Service à la clientèle de Mattel. Conserver ce mode d'emploi pour s'y référer en cas de besoin car il contient des informations importantes.

Por favor, remova todo o conteúdo de dentro da embalagem e compare com os itens aqui apresentados. Se algum item estiver faltando, entre em contato com o Serviço de Atendimento ao Consumidor da Mattel (Brasil: 0800-550780). Estas instruções trazem informações importantes, guarde-as para futuras referências.

WARNING:
CHOKING HAZARD - Small parts.
Not for children under 3 years.

ADVERTENCIA:
PELIGRO DE ASFIXIA. Juguete no recomendado para menores de 3 años. Contiene piezas pequeñas que podrían provocar asfixia en caso de ser ingeridas por el niño/a.

ATTENTION:
DANGER D'ETOUFFEMENT -
Petits éléments. Ne convient pas
aux enfants de moins de 36 mois.

ADVERTENCIA: PELIGRO DE ATRAGANTAMIENTO. Juguete no recomendado para menores de 3 años, porque contiene piezas pequeñas que podrían provocar asfixia en caso de ser ingeridas o inhaladas por el/la niño/a.
ATENÇÃO: Não indicado / não recomendável para crianças menores de 3 (três) anos por conter parte(s) pequena(s) que pode(m) ser engolidas(s) ou aspiradas(s) podendo provocar asfixia.

LET'S PLAY! • ¡A JUGAR! • PLACE AU JEU! • VAMOS BRINCAR!

Apply labels by number as shown.

Pegar las etiquetas por número, tal como se muestra.

Coller les autocollants en suivant les numéros indiqués.

Cole os adesivos de acordo com os números, conforme figura.

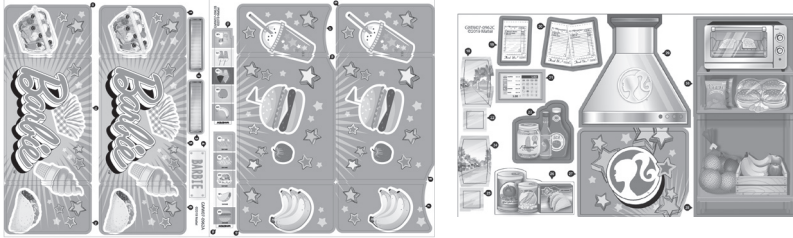

1

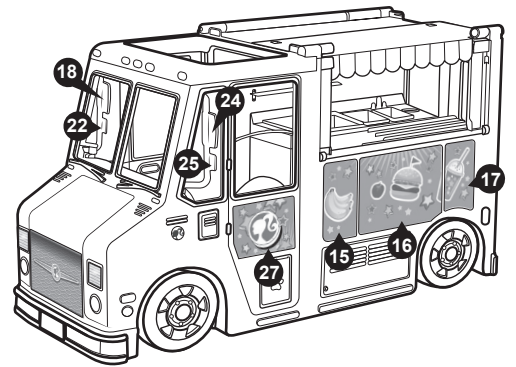

2

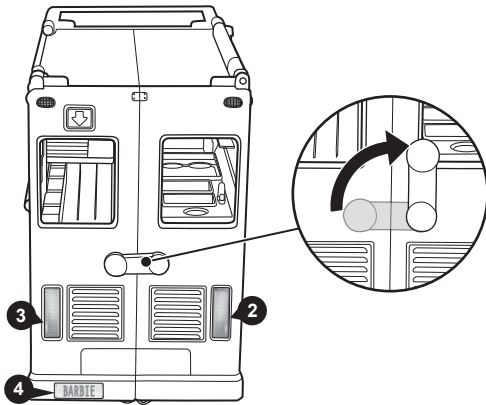

3

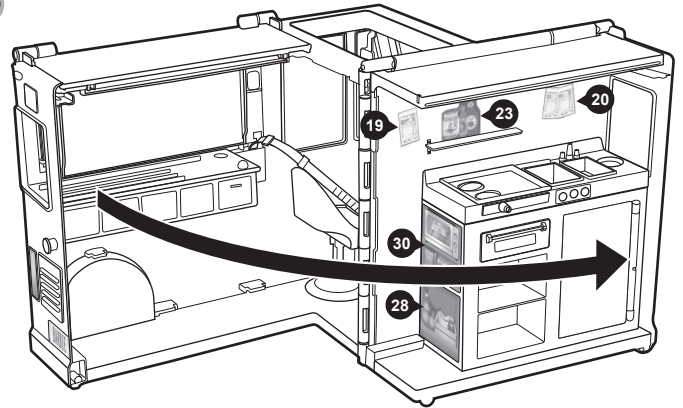

4

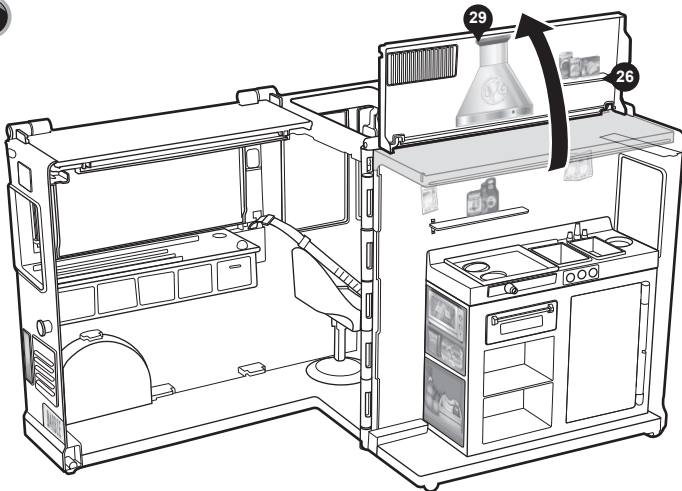

5

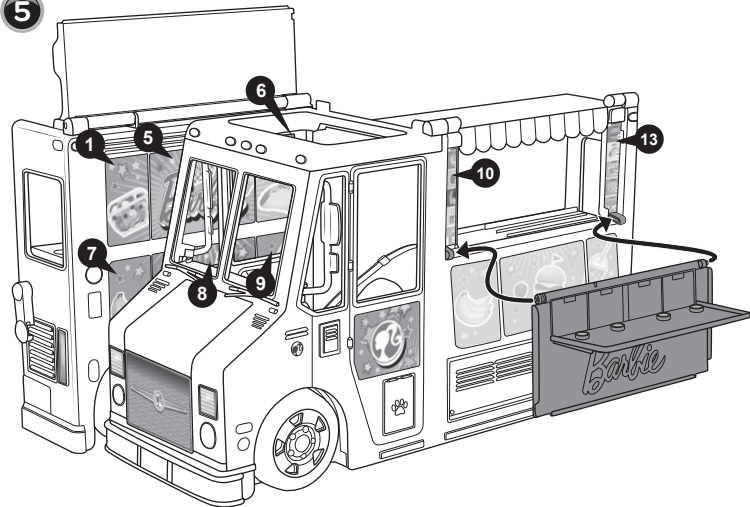

6

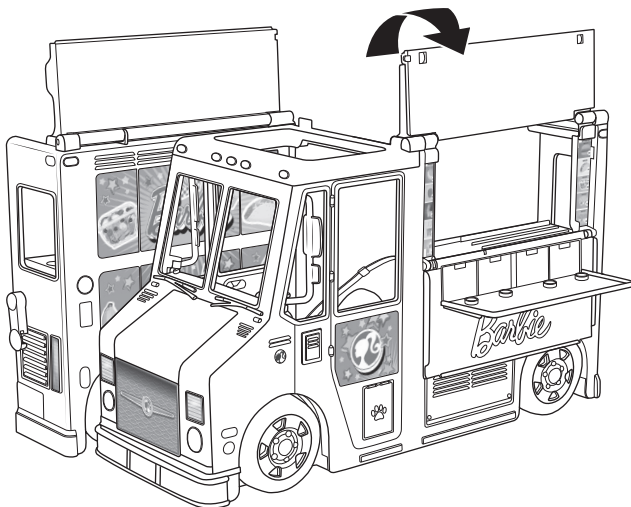

7

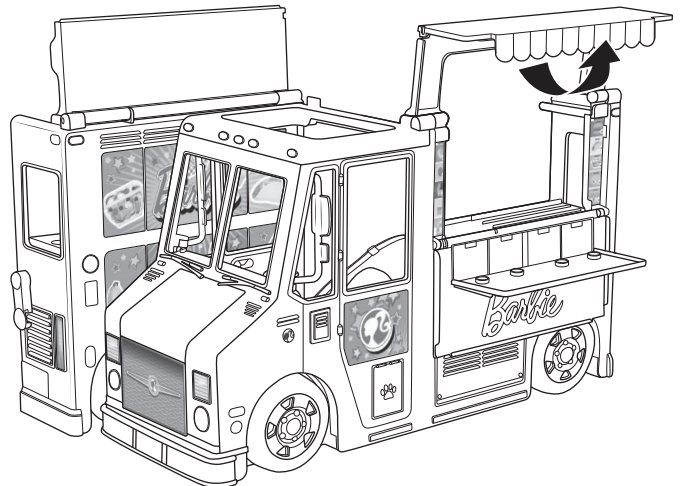

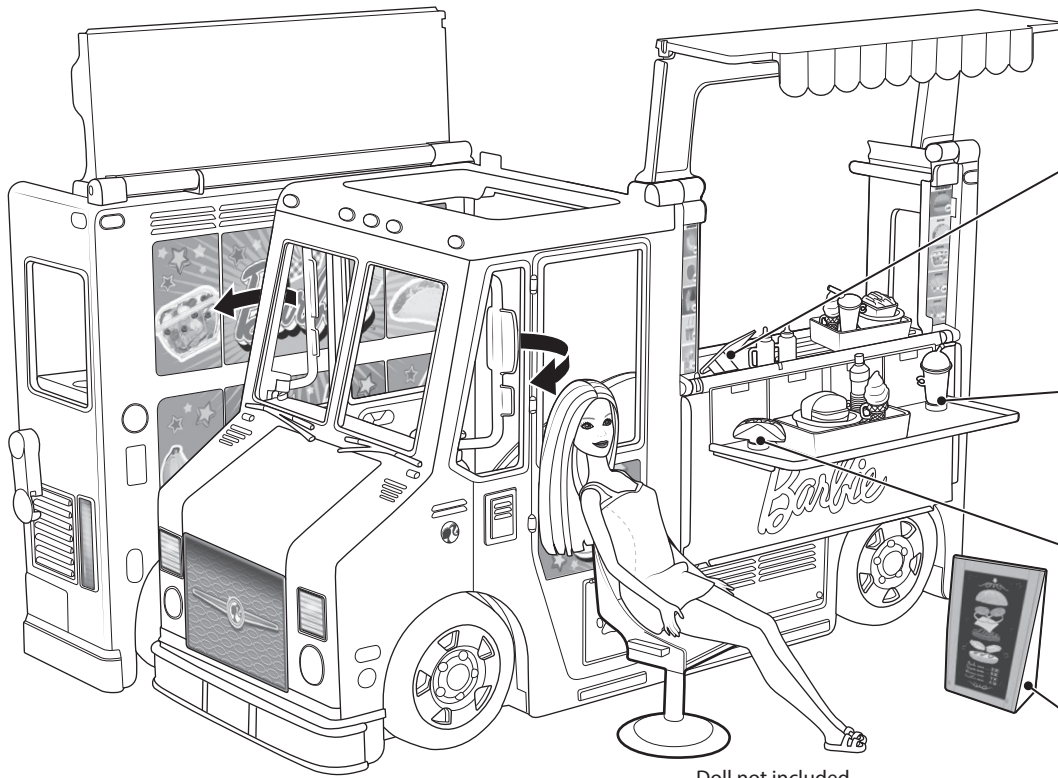

Doll not included.
Muñeca no incluida.
Poupée non incluse.
Boneca não incluída.

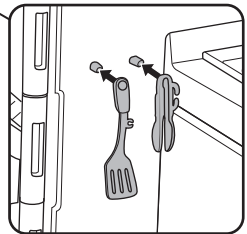
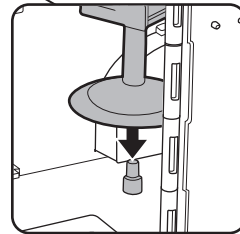
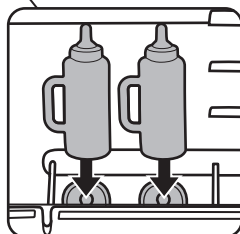
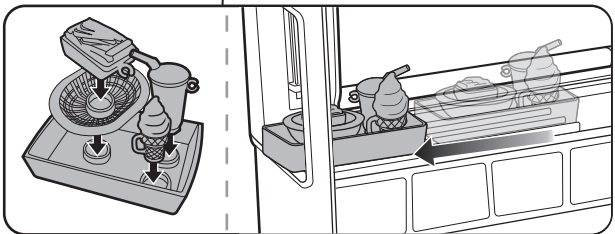
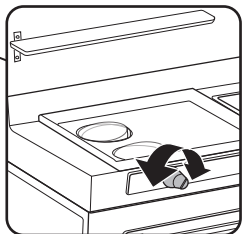
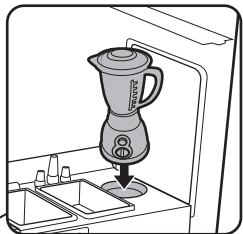
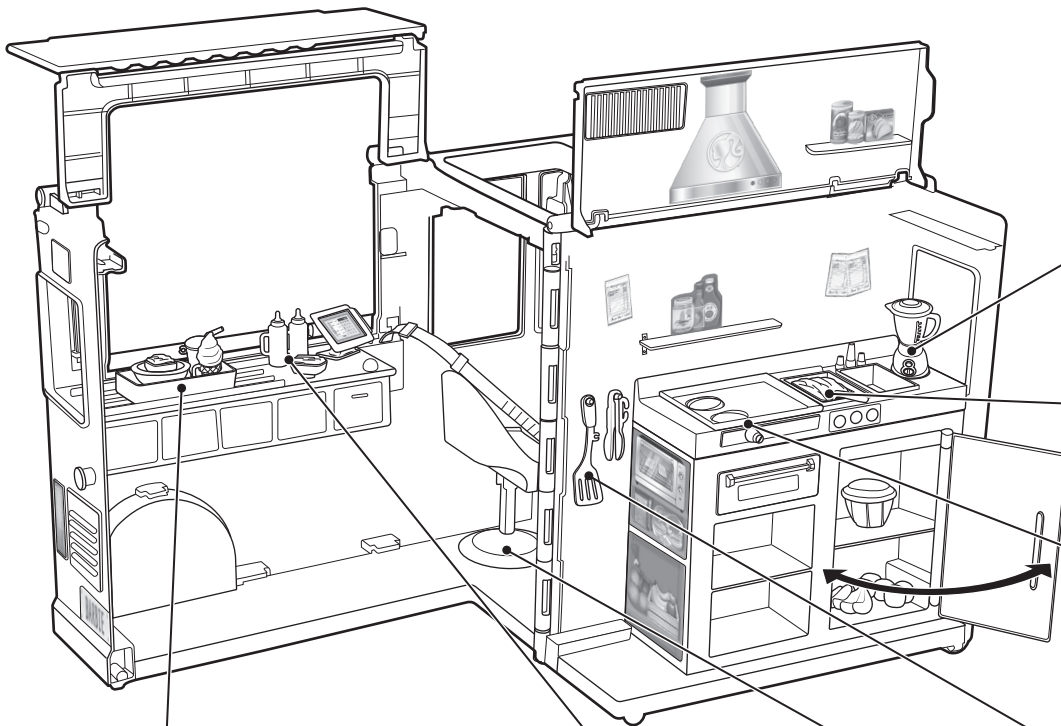
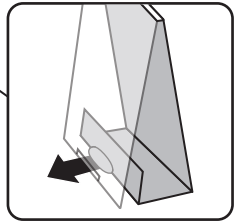
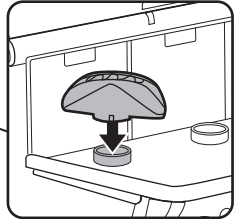
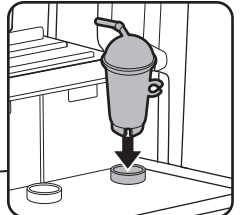

STORAGE • ALMACENAMIENTO • RANGEMENT • PARA GUARDAR

1

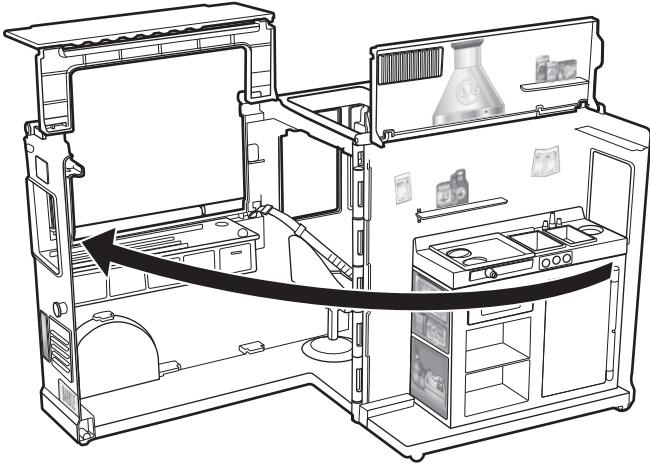

2

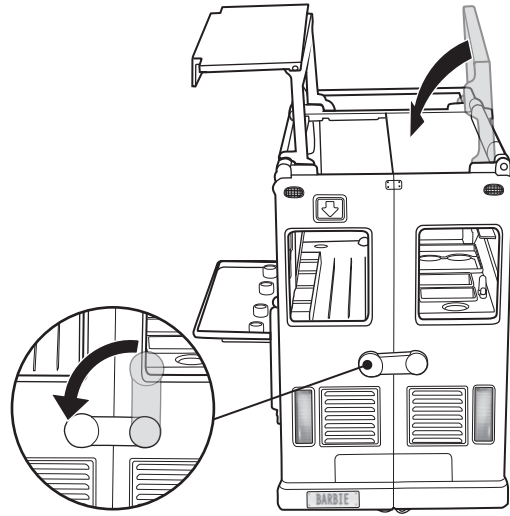

3

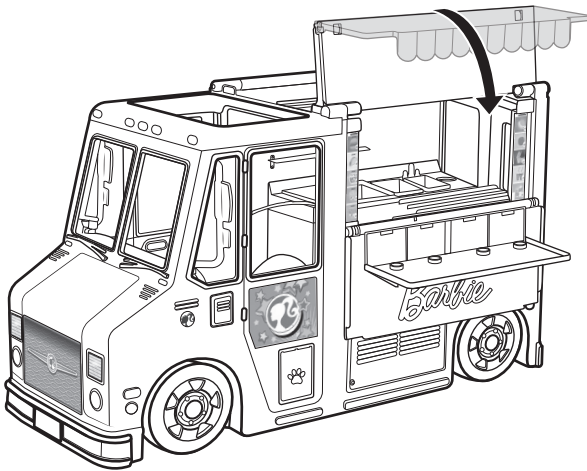

4

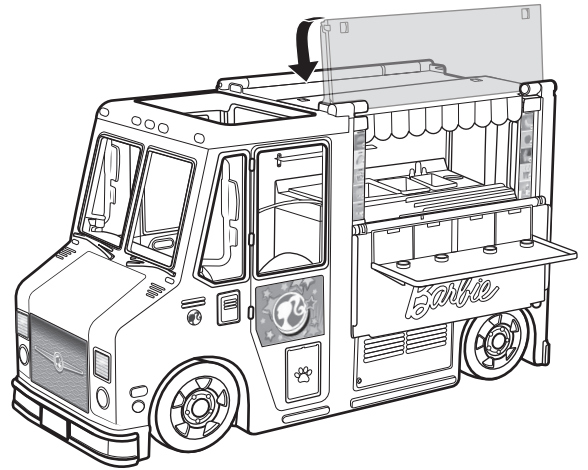

5

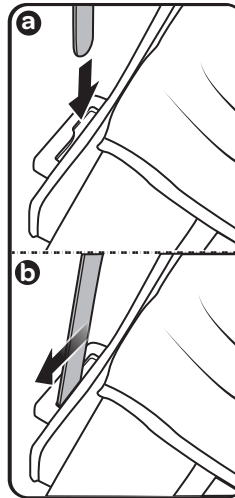
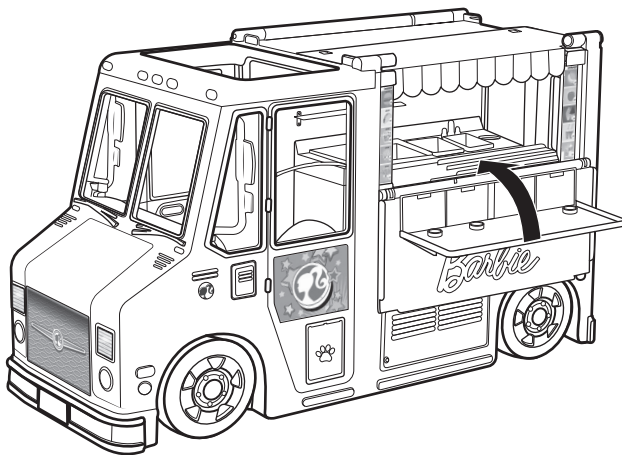

Doll not included.
Muñeca no incluida.
Poupée non incluse.
Boneca não incluída.

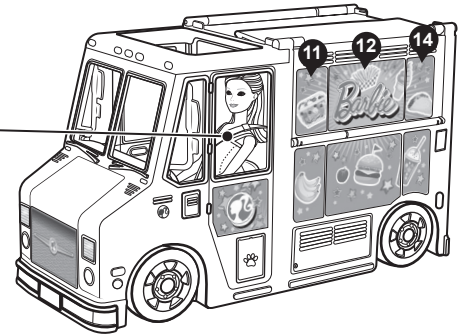

Mattel, Inc., 636 Girard Avenue, East Aurora, NY 14052, U.S.A. Consumer Services 1-800-524-8697. Mattel Canada Inc., Mississauga, Ontario L5R 3W2. You may call us free at / Composez sans frais le 1-800-524-8697. Mattel Europa B.V., Gondel 1, 1186 MJ Amstelveen, Nederland. Mattel U.K. Limited, The Porter Building, 1 Brunel Way, Slough SL1 1FQ, UK. Mattel Australia Pty. Ltd., 658 Church St., Richmond, Victoria, 3121. Consumer Advisory Service - 1300 135 312. Mattel East Asia Ltd., Room 503-09, North Tower, World Finance Centre, Harbour City, Tsimshatsui, HK, China. Tel.: (852) 3185-6500. Diimport & Diedarkan Oleh: Mattel Continental Asia Sdn Bhd. Level 19, Tower 3, Avenue 7, No. 8 Jalan Kerinchi, Bangsar South, 59200 Kuala Lumpur, Malaysia. Mattel South Africa (PTY) LTD, Office 102 I3, 30 Melrose Boulevard, Johannesburg 2196. Importado y distribuido por Mattel de México, S.A. de C.V., Miguel de Cervantes Saavedra No. 193, Pisos 10 y 11, Col. Granada, Alcaldía Miguel Hidalgo, C.P. 11520, México, Ciudad de México. R.F.C. MME-920701-NB3. Tels.: 59-05-51-00 Ext. 5206 ó 01-800-463-59-89. Mattel Chile, S.A., Avenida Américo Vespucio 501-B, Quilicura, Santiago. Tel.: 1230-020-6213. Servicio al consumidor Venezuela: Tel.: 0-800-100-9123. Mattel Argentina, S.A., Av. Libertador 1000, Piso 11 – Oficinas 109 y 111, Vicente López – Prov. Buenos Aires. Tel.: 0800-666-3373. Mattel Colombia, S.A., Calle 123#7-07 P.5, Bogotá. Tel.: 01800-710-2069. Mattel Perú, S.A., Av. Juan de Arona # 151, Centro Empresarial Juan de Arona, Torre C, Piso 7, Oficina 704, San Isidro, Lima 27, Perú. RUC: 20425853865. Reg. Importador: 02350-12-JUE-DIGESA. Tel.: 0800-54744. E-mail Latinoamérica: Servicio.Clientes@Mattel.com. Distribuido por : Mattel do Brasil Ltda.- CNPJ : 54.558.002/0001-20 - Rua Verbo Divino, 1488 - 2º. Andar - 04719-904 - Chácara Santo Antônio - São Paulo - SP - Brasil. Serviço de Atendimento ao Consumidor: fone 0800-550780. E-mail: sac.matteldobrazil@mattel.com. Mattel France, Parc de la Cerisaie, 1/3/5 allée des Fleurs, 94260 Fresnes Cedex. N° Cristal 0969 36 99 99 (Numéro non surtaxé) ou www.lesjouetsmattel.fr. Mattel España, S.A., Aribau 200. 08036 Barcelona. cservice.spain@mattel.com Tel: 902203010 http://www.service.mattel.com/es.