

MARIO KART™



PLEASE KEEP THESE INSTRUCTIONS FOR FUTURE REFERENCE AS THEY CONTAIN IMPORTANT INFORMATION. COLORS AND DECORATIONS MAY VARY.

AGE
5+



HOTWHEELS.COM
GNM22-0970
1102297631-D0M

BOWSER'S CASTLE CHAOS INSTRUCTIONS

1 HERE'S WHAT YOU GET!

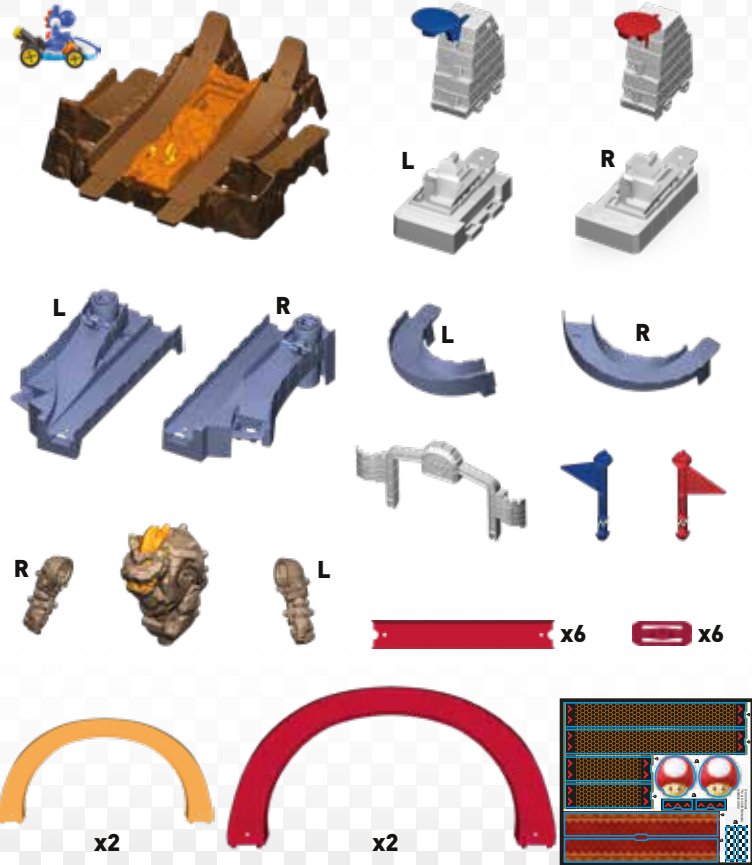

2 APPLY LABELS

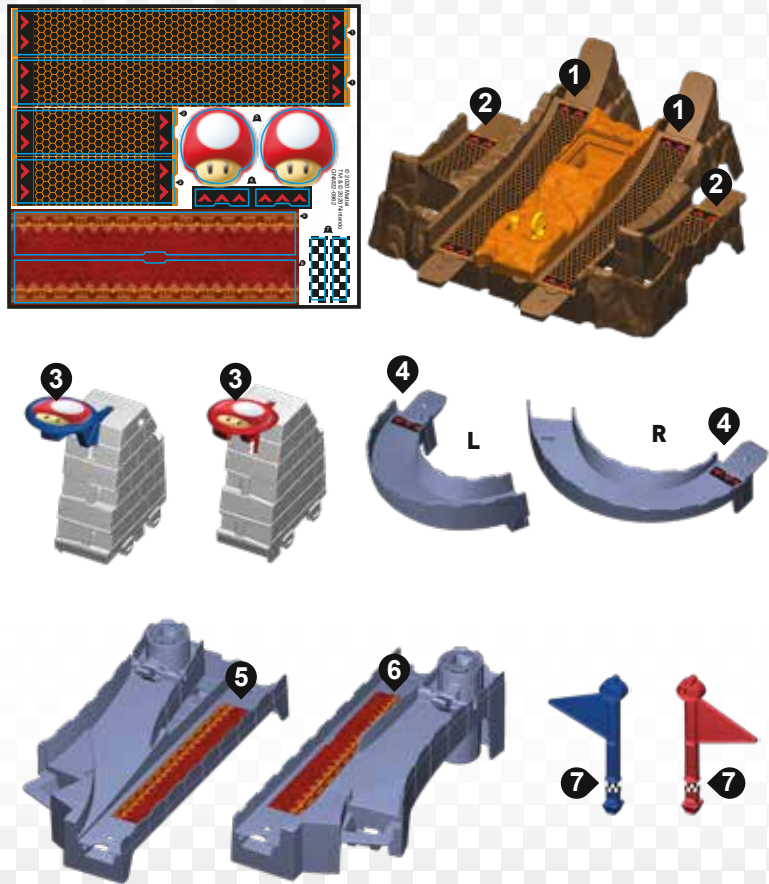

3 BUILD

Refer to the Molded Letters on product parts for easy assembly.

Welcome to Hot Wheels® Mario Kart - Bowser's Castle Chaos.

Follow the steps and align the molded letters on pieces with the ones shown in the instructions for correct assembly.

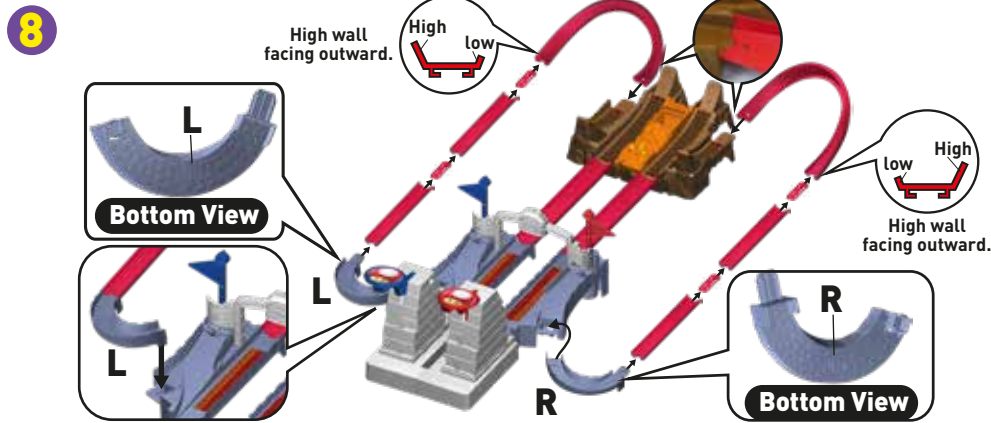
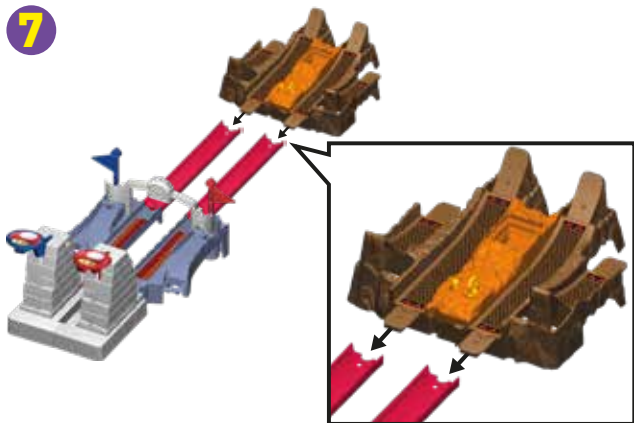
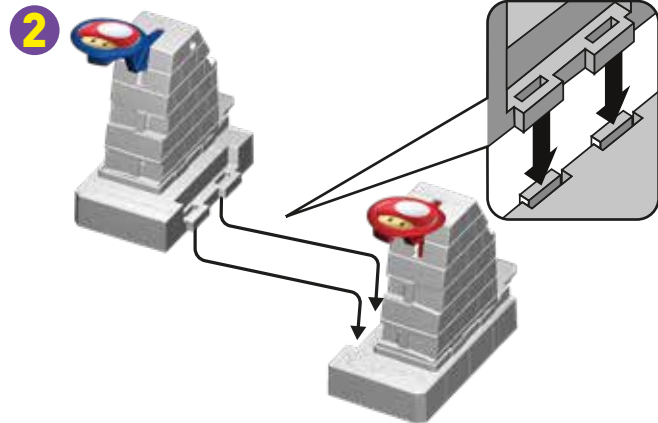
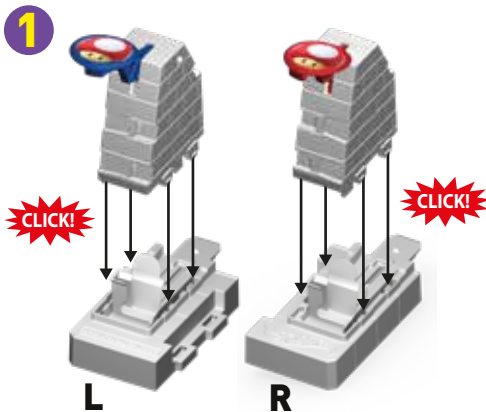

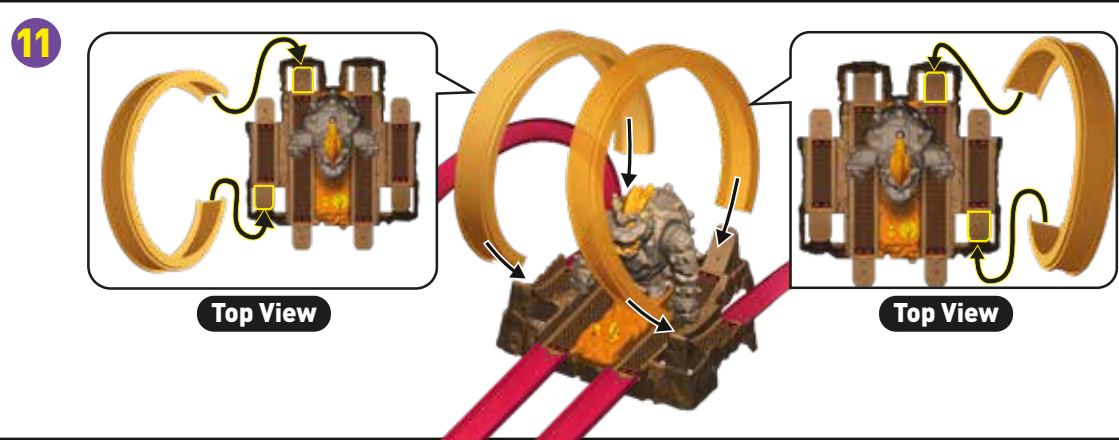
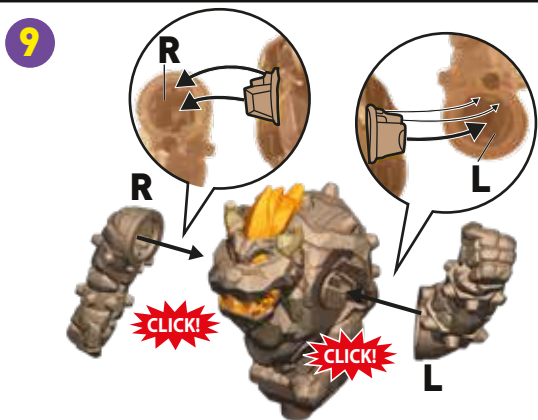
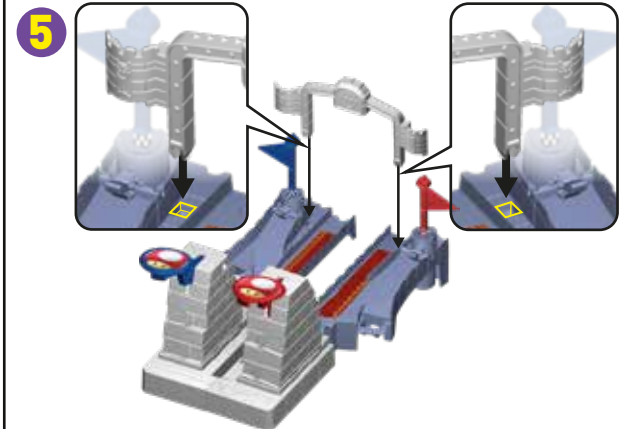
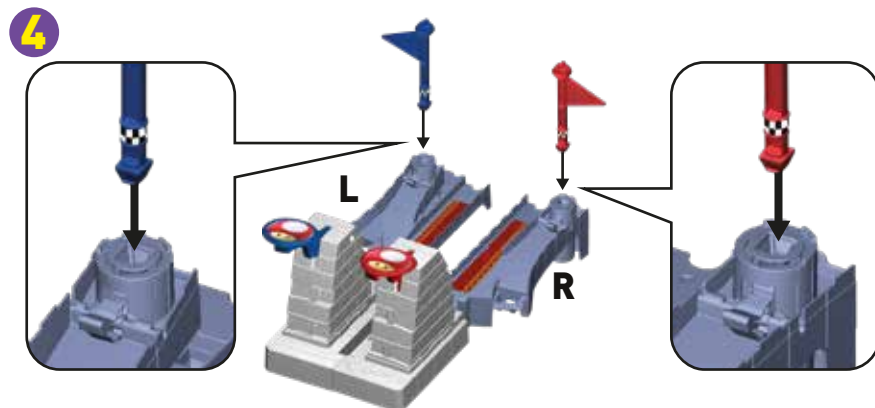
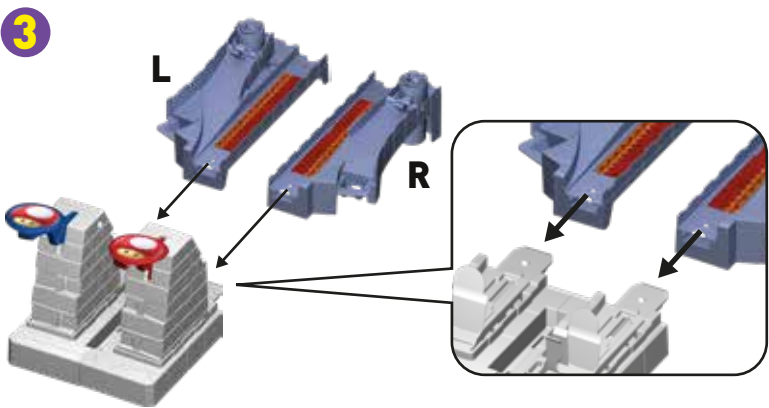

6

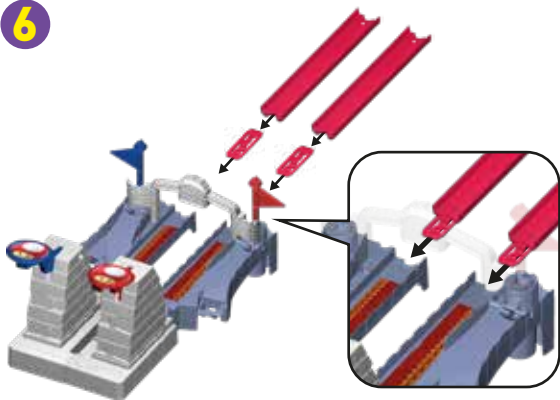

4 RACE

- 1 Load karts onto the launchers.

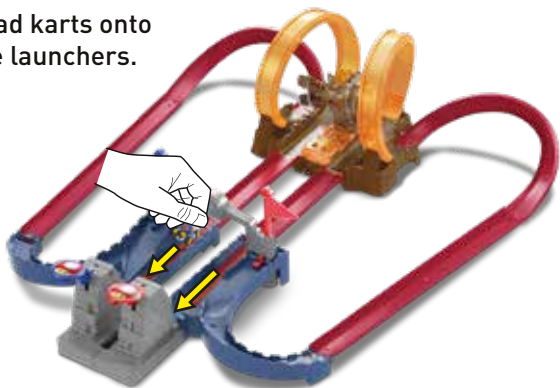

One vehicle included. Additional vehicles sold separately. Not for use with some Hot Wheels® vehicles.

- 5 Slam both **SUPER MUSHROOM**  launchers to begin the race!



2 Lift both RED and BLUE flags to the top.

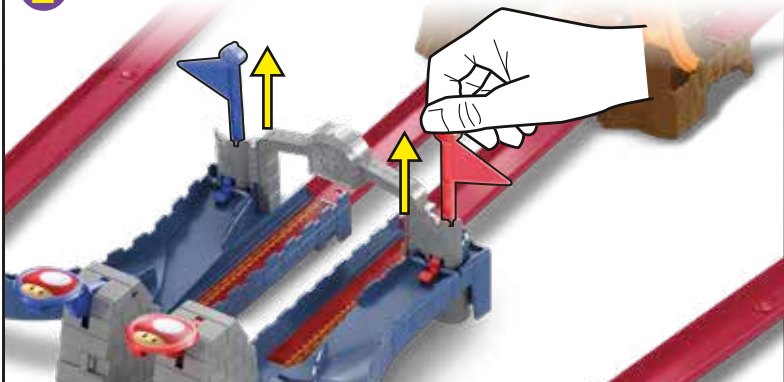

3 Slide toggle to LOCK (🔒) Bowser and wind coin switch.

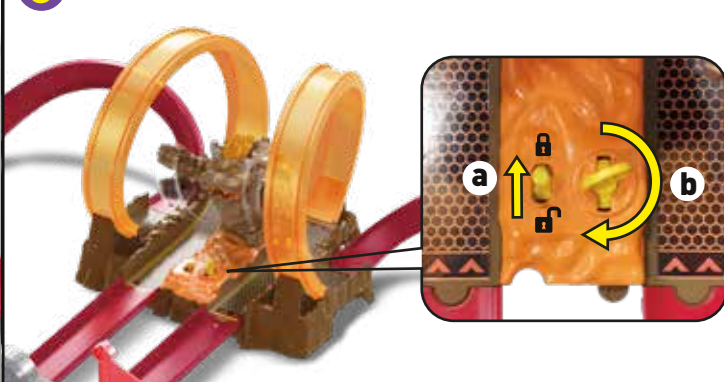

4 Slide toggle to UNLOCK (🔓) Bowser to start swinging his arms.



6 Watch out! Bowser may knock you off the track!

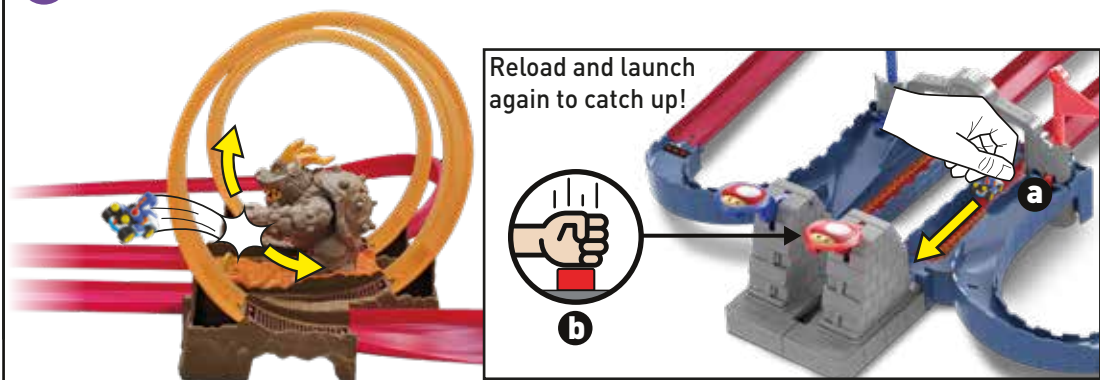

7 Flag drops one notch each time you finish a lap.

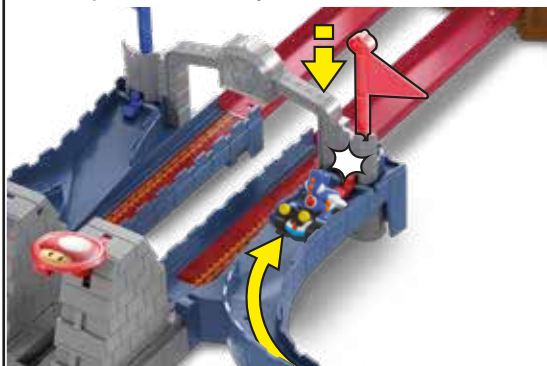

8 Relaunch with **SUPER MUSHROOM** (🍄) after each lap. First to complete 5 laps wins!

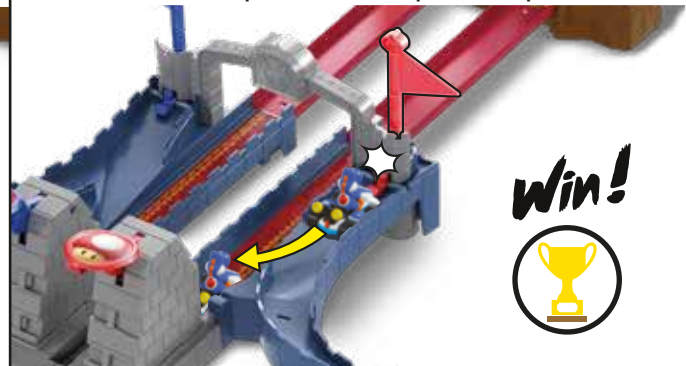

5 MORE WAYS TO RACE

ADD EXPANSION TRACK SETS TO CREATE THE ULTIMATE MARIO KART RACE!

ADVERTISEMENT

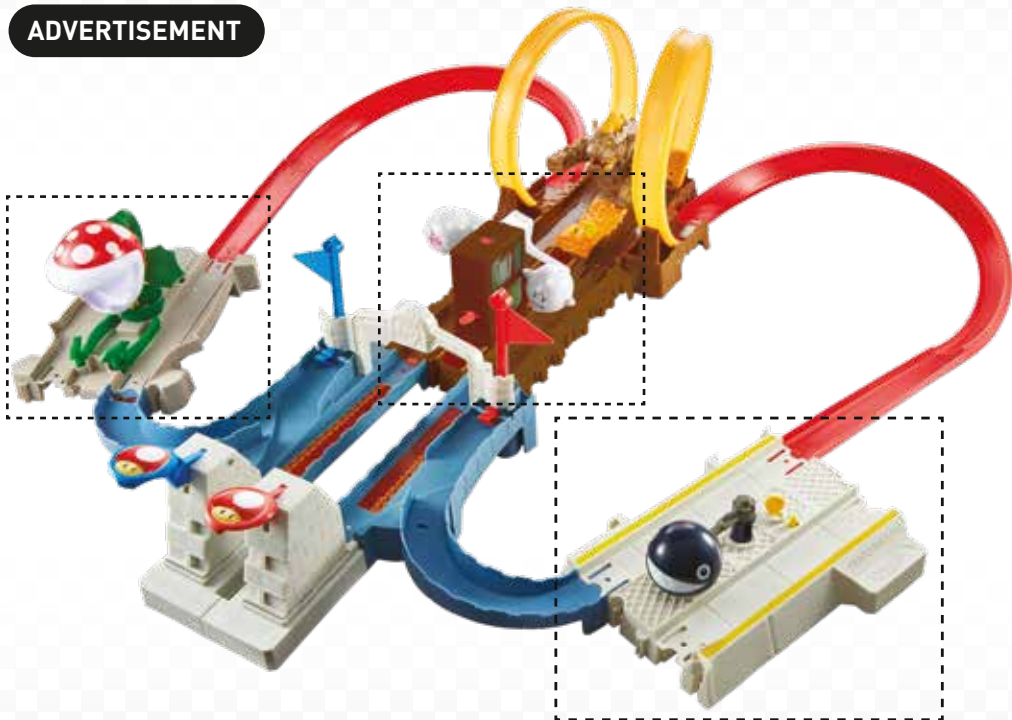

BOO'S SPOOKY SPRINT TRACK SET
GNM23

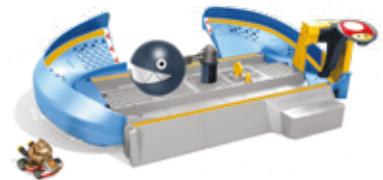

CHAIN CHOMP TRACK SET
GKY48



PIRANHA PLANT SLIDE TRACK SET
GFY47

Refer to each expansion track set instructions for assembly details and play features. Each sold separately, subject to availability.

