



# HALO

GRN05



## Forerunner Ring Installation • Installation d'anneaux Forerunner Instalación de Amillo Forerunner • Instalação de anel Forerunner

Installazione di Forerunner Ring | Ring-Halo der Forerunners | Instalacja pierścienia prekursora | Installatie Forerunner-ring | Установка Кольца Предтечи  
Εγκατάσταση δακτυλίου Forerunner | Forerunner Halkası Kurulumu | Forerunner Ring telepítés | Installation av Forerunner-ring | Forerunner-renkaan  
asennus | Installation i Forerunner-ring | Forerunner Ring-installasjon | Instalace prstence Forerunner | Inštalácia prstenca Forerunner | تثبيت حلقة فوررانر

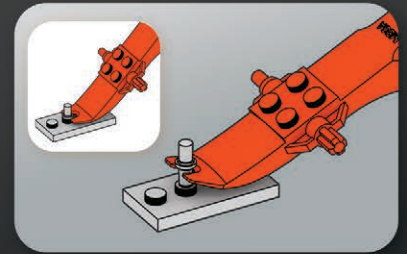
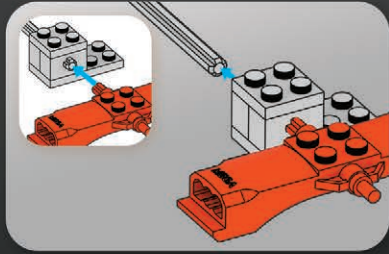
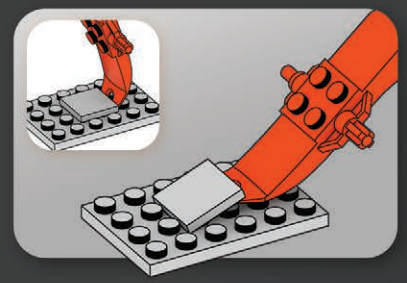
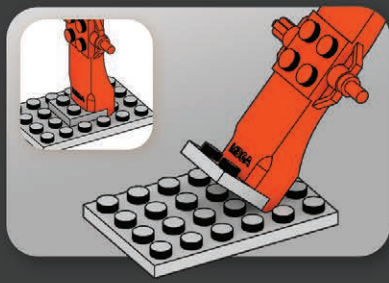

## Building Tool Outil de construction

Herramienta de construcción  
Bauwerkzeug  
Ferramenta de montagem  
Инструмент для конструирования

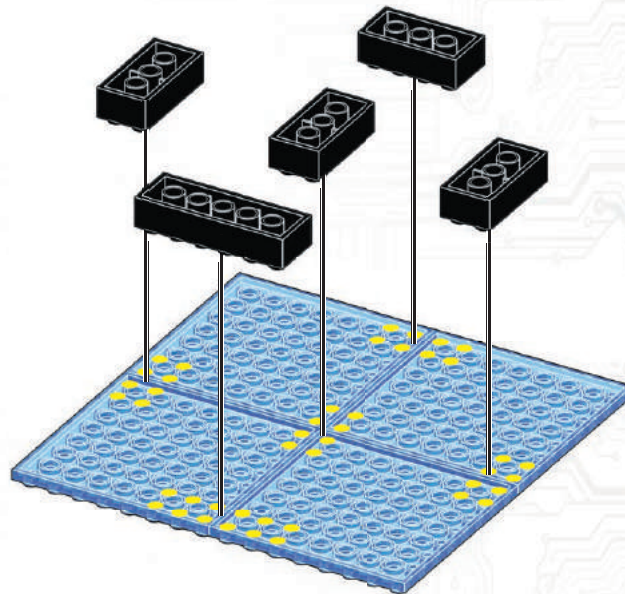
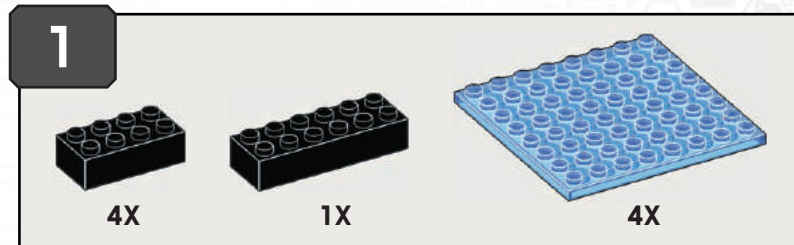

2



2X



4X

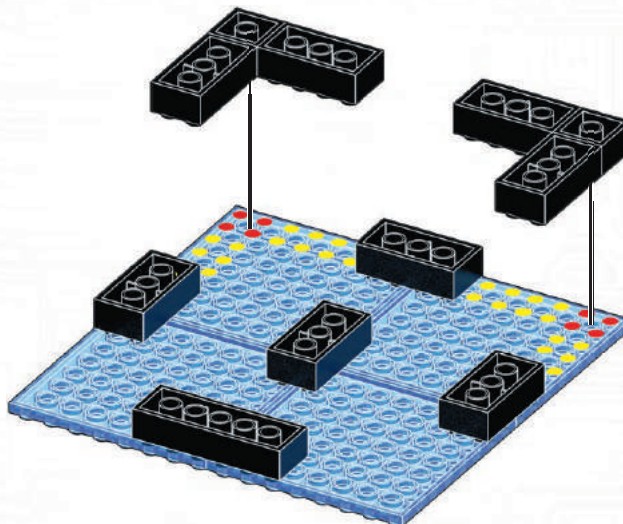

3



2X



2X



2X

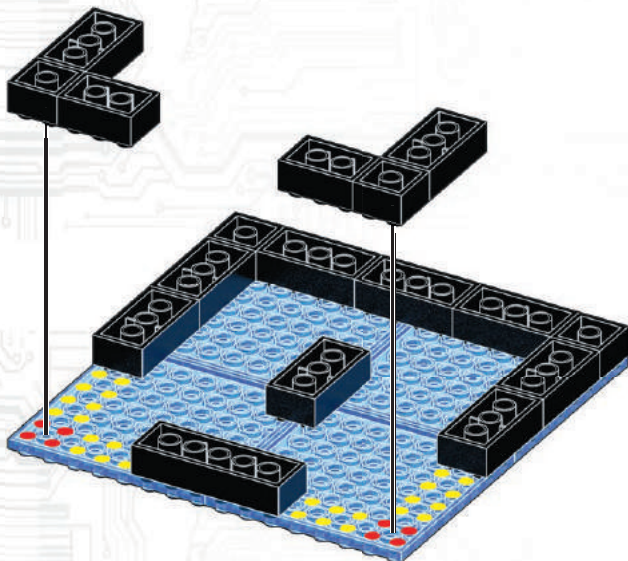

1

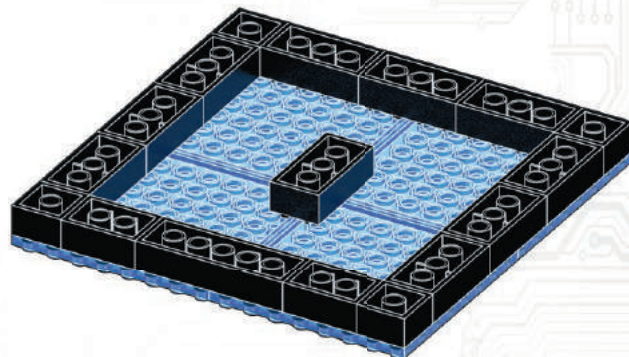

2

4



5X

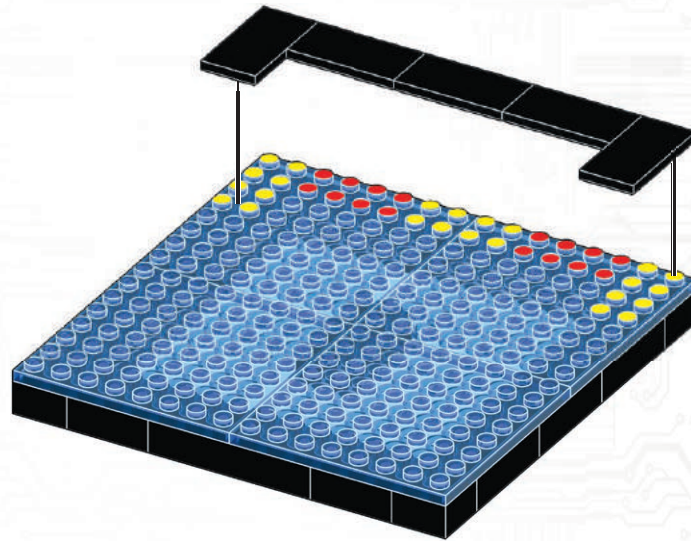

5



5X

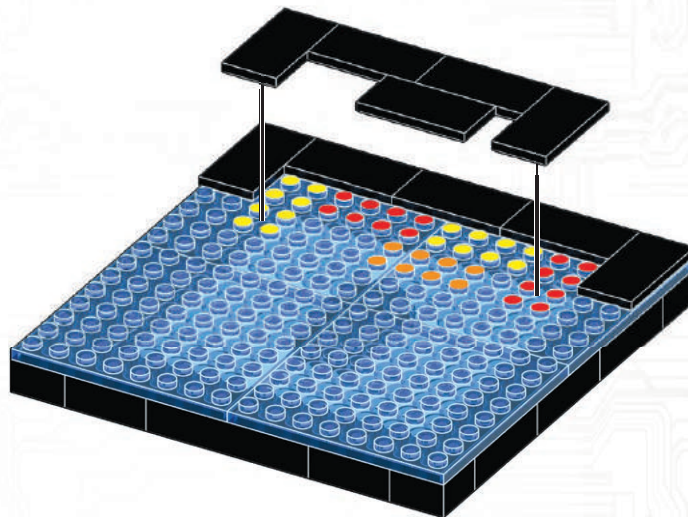

6



2X



2X



1X

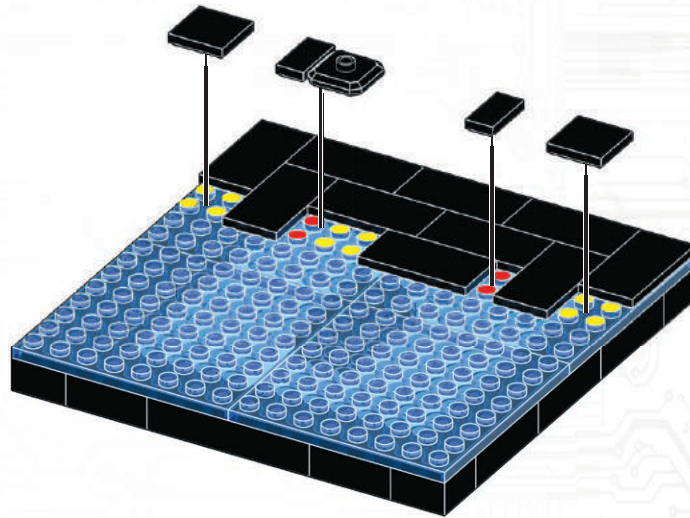

7



1X

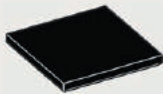

3X

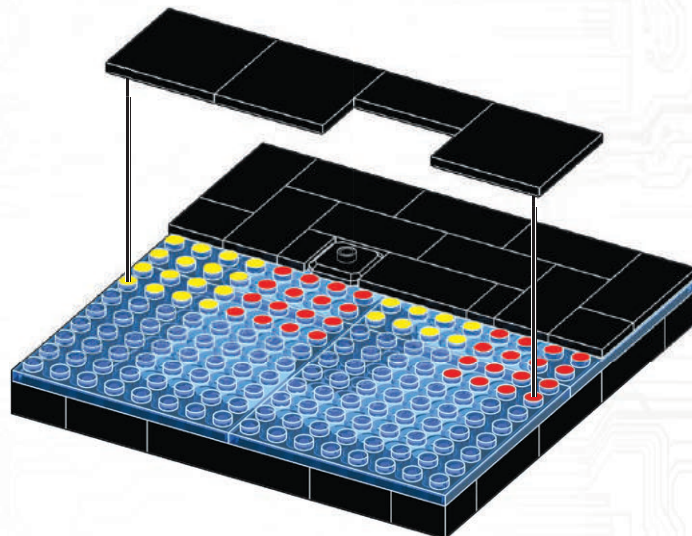

8



2X



3X



1X

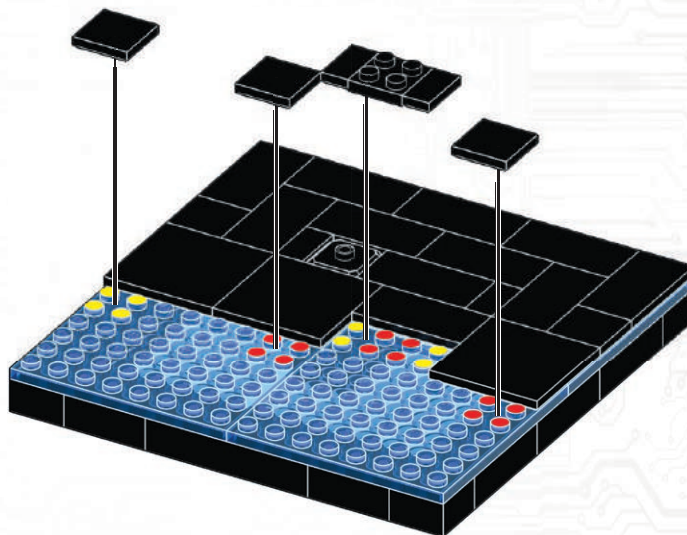

9



1X



2X

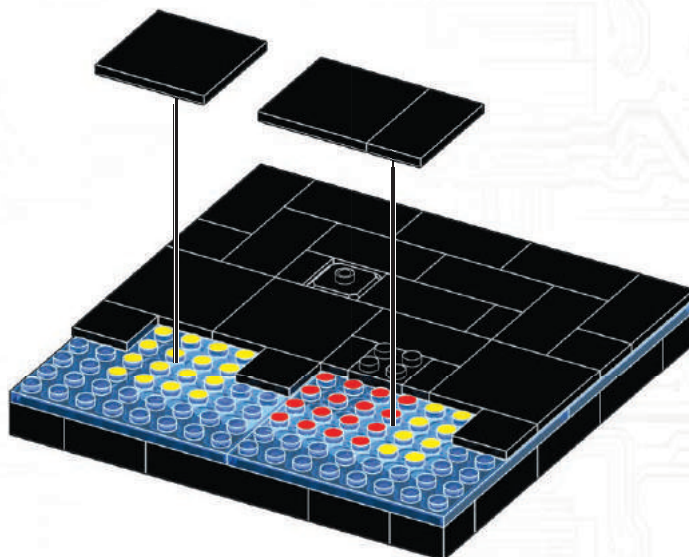

10



1X



1X



4X

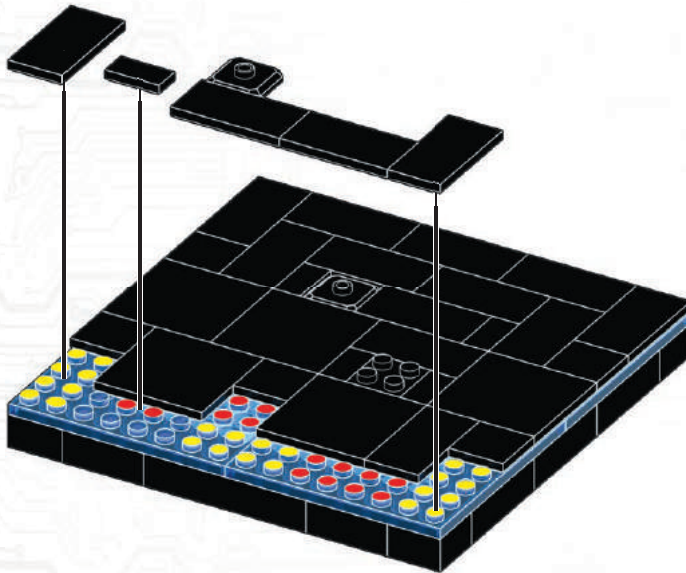

1

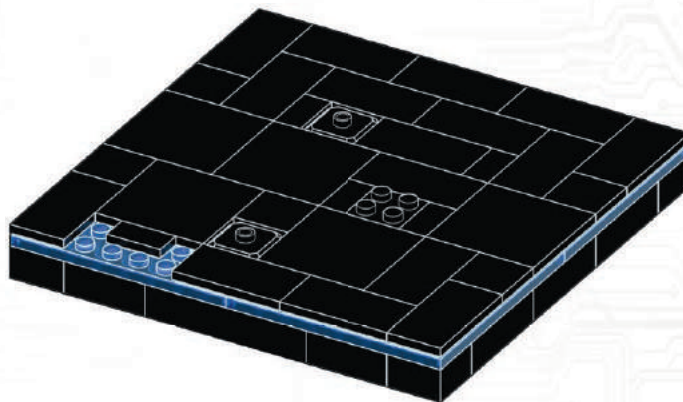

2

11

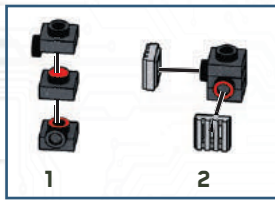

12

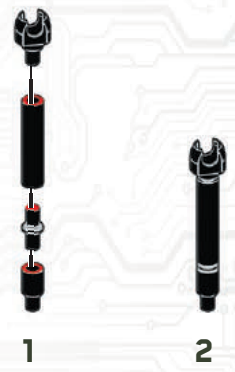

13





14



1X

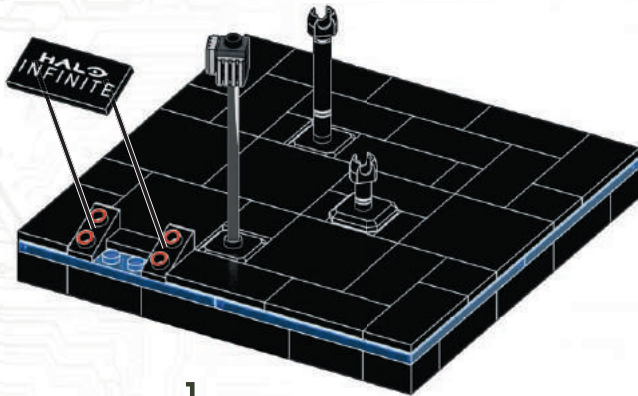

1

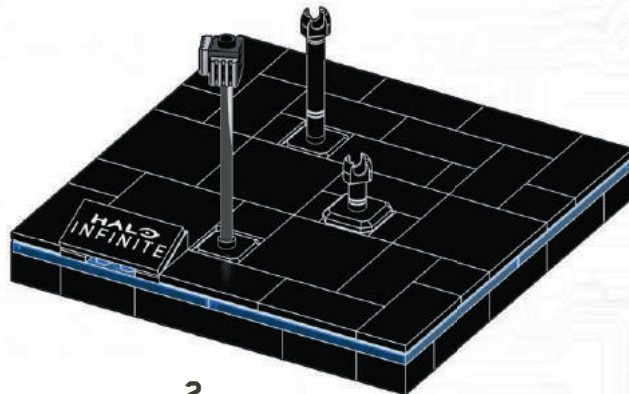

2

15

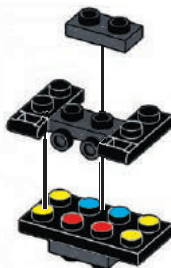

1



2



3

x3

16

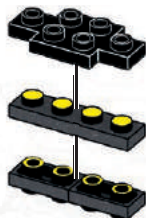

1

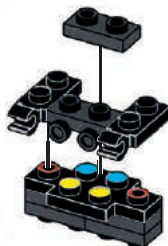

2



3

x3

17

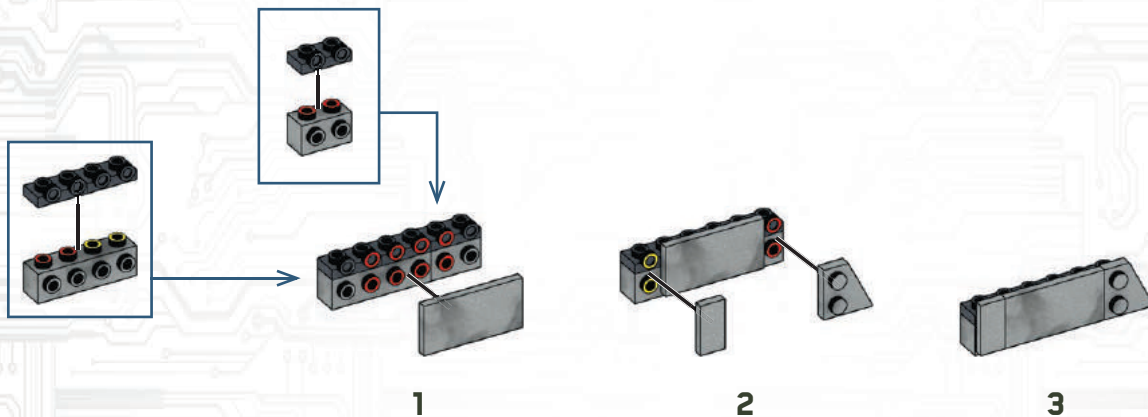
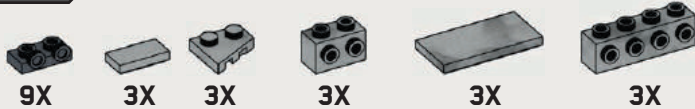

x3

18

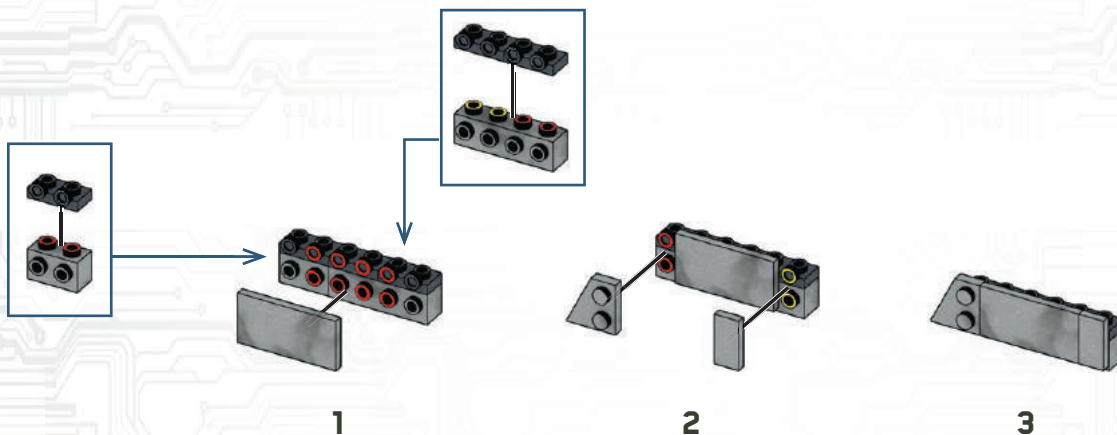
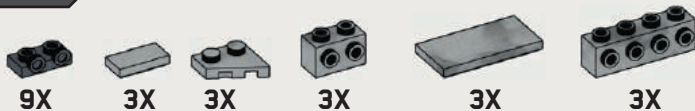

x3

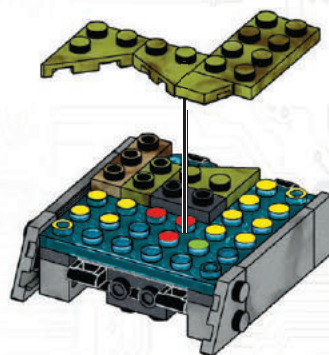
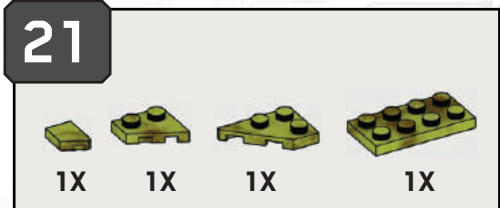
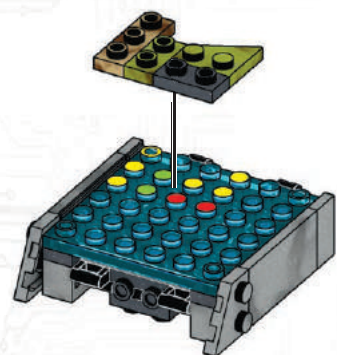
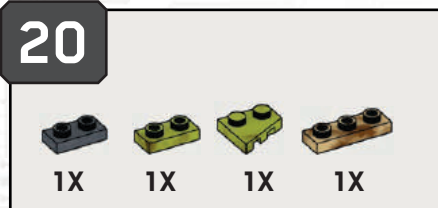
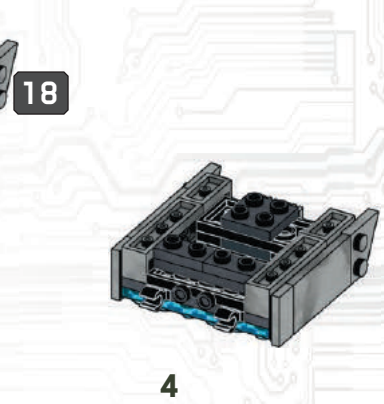
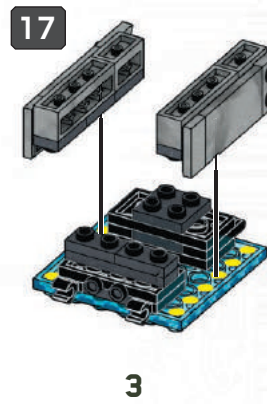
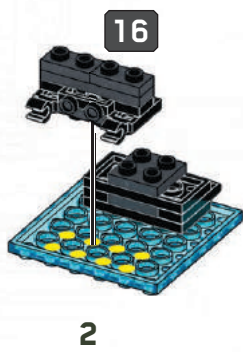
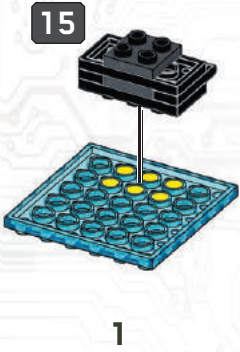
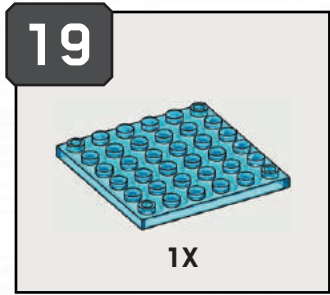

22

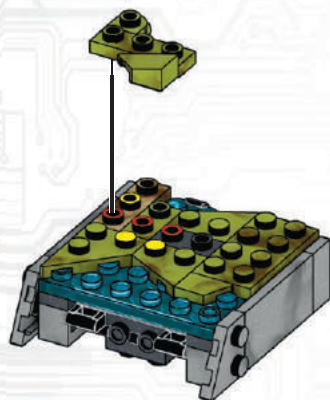

23

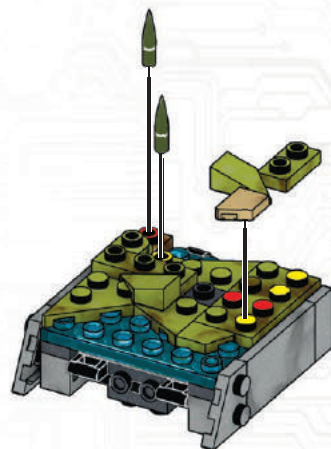

24

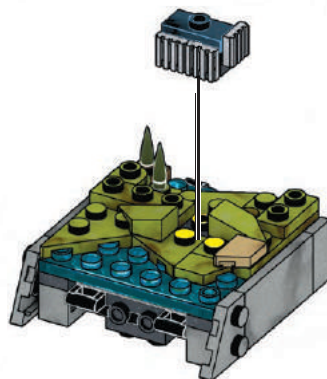
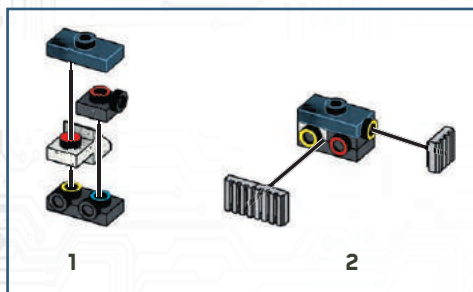

25

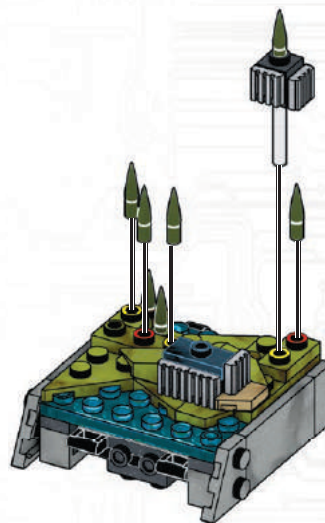
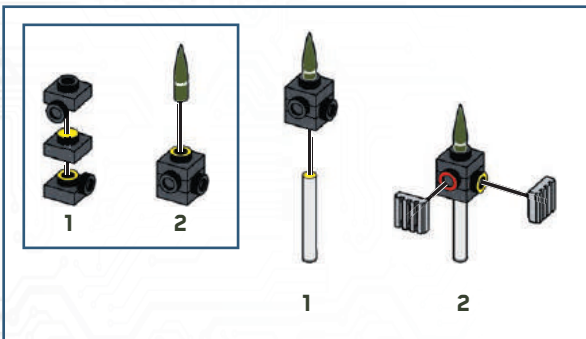

26

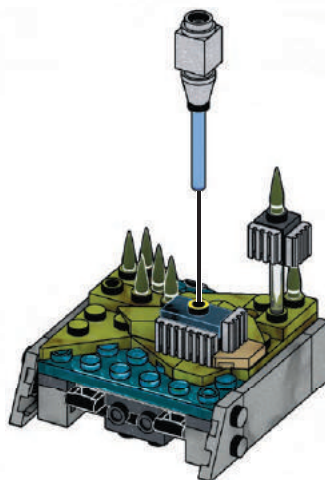
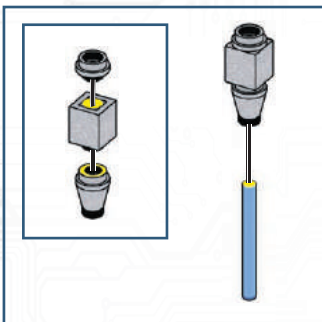

27



2X

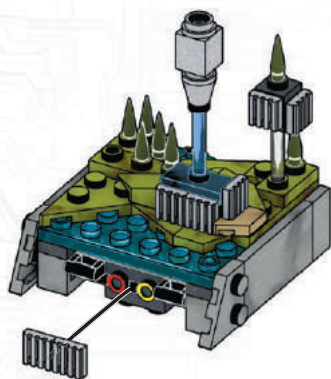

1

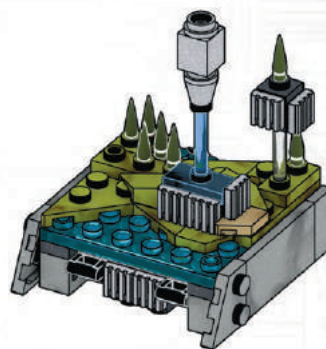

2

28



1X



3X



1X



1X



1X

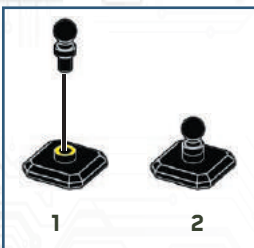

1

2



1



2

29

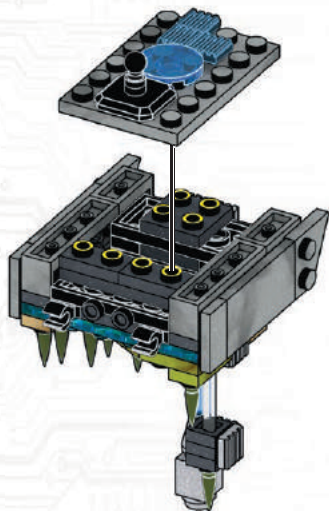

1

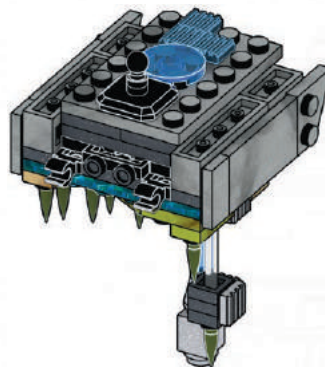

2

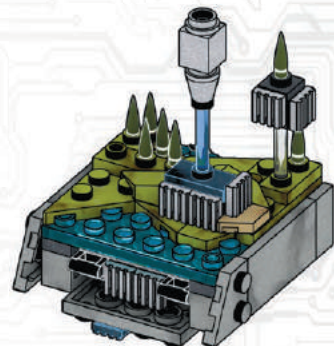

3

30



1X



1

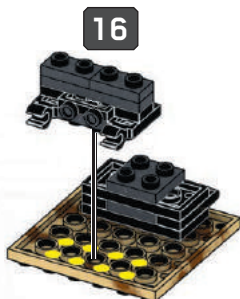

2

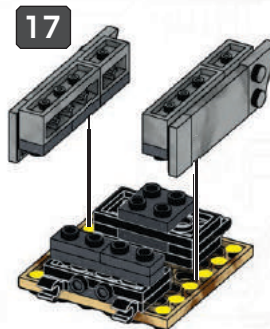

3

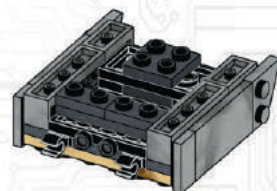

4



31

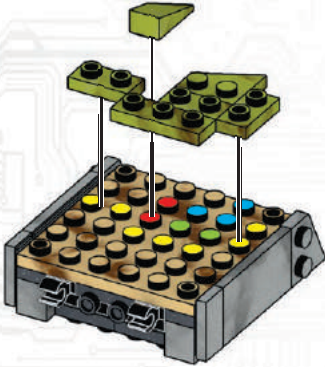

32

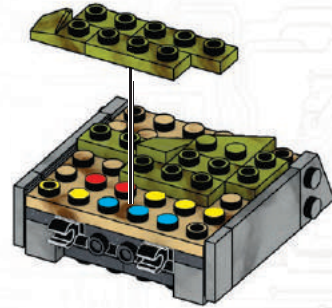

33

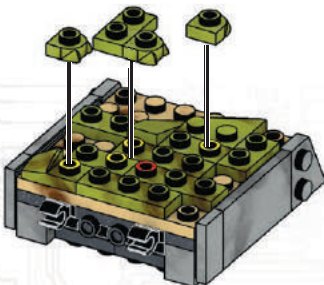

34

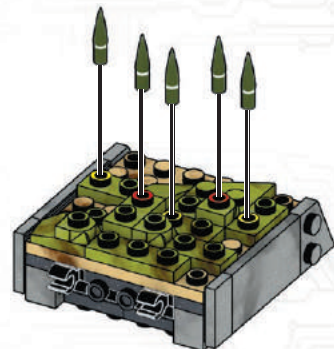

35



5X

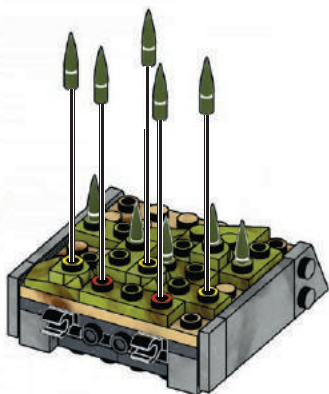

1

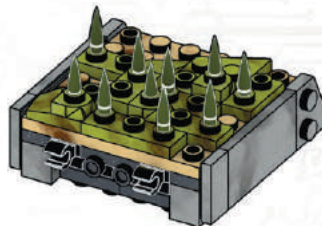

2

36



1X



9X



1X



1X



1



2

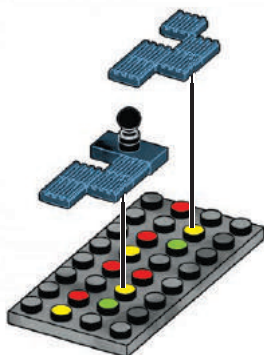

1

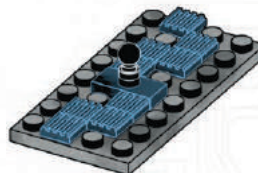

2

37

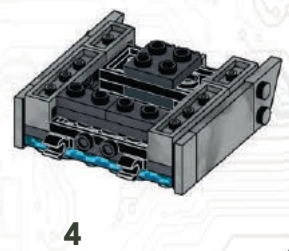
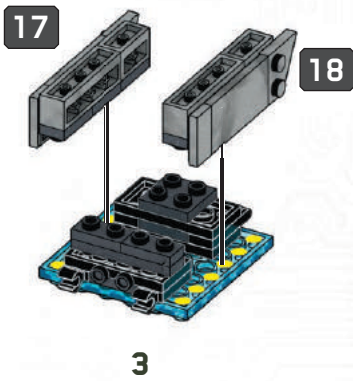
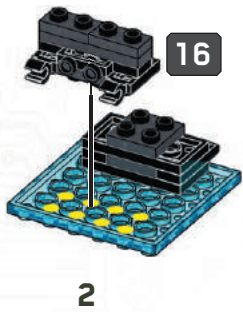
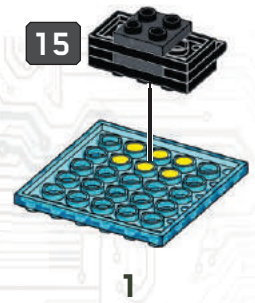
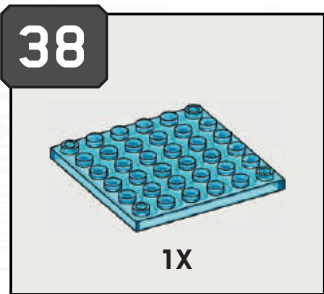
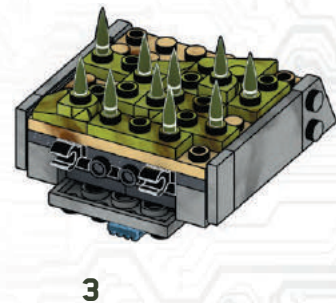
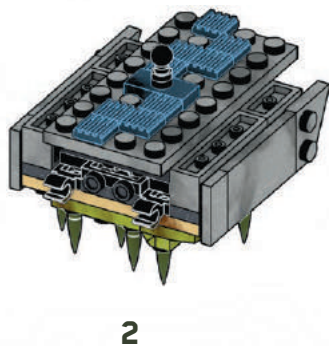
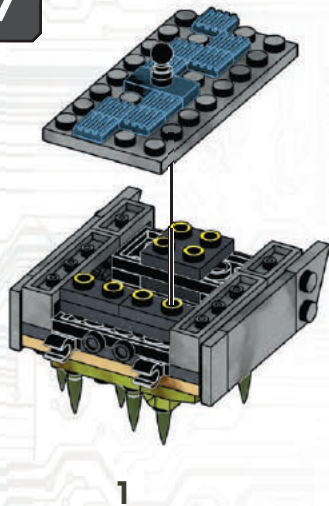

39



40

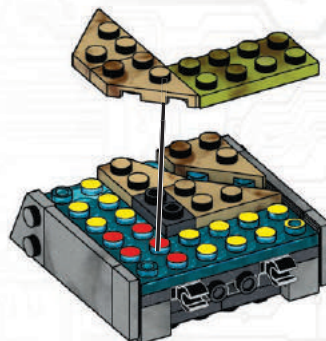

41

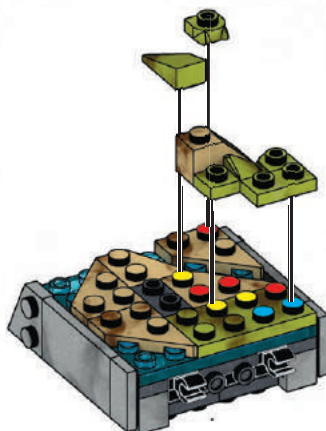

42

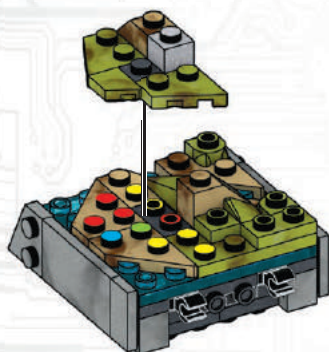

43

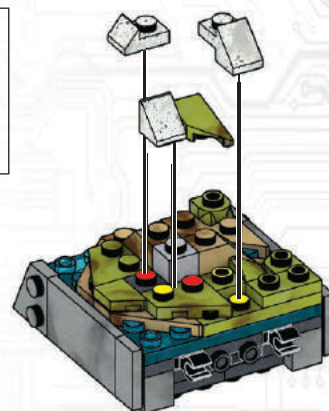
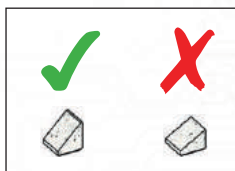

44

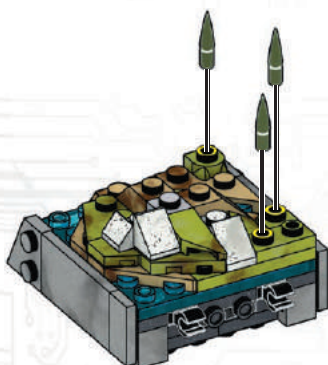

45

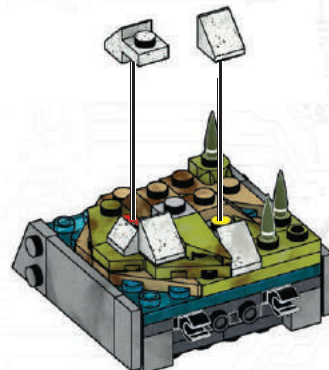
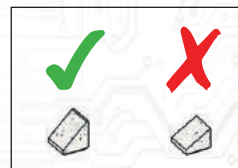

46



1X



1X

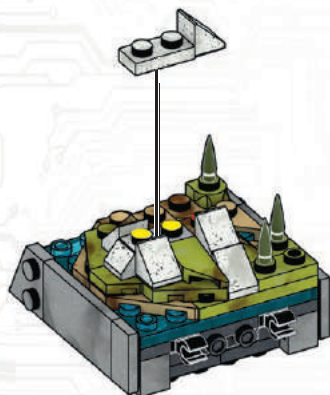

47



1X



1X

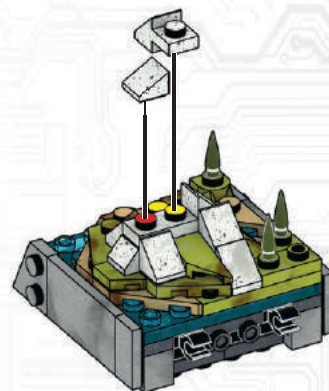

48



1X

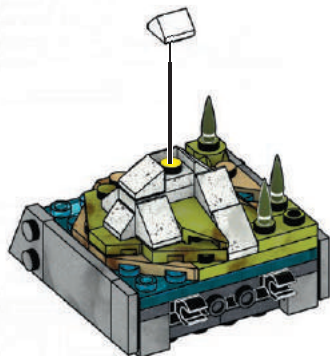

1

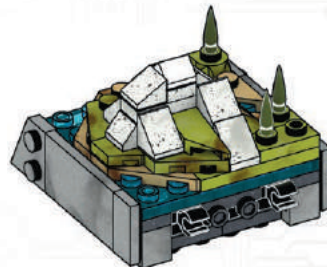

2

49

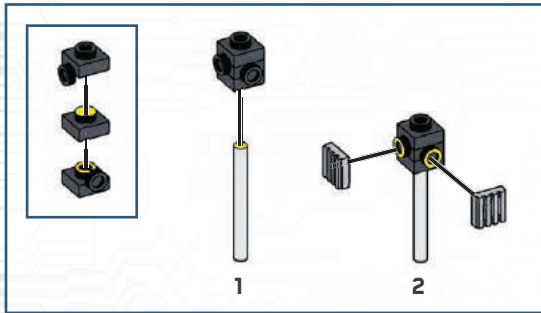

50

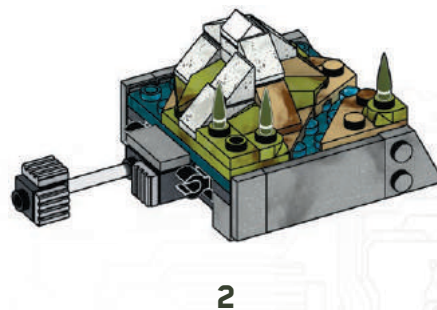
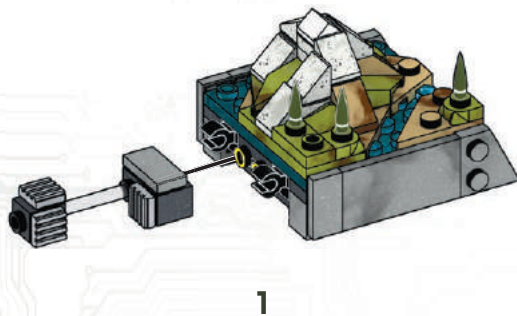

51

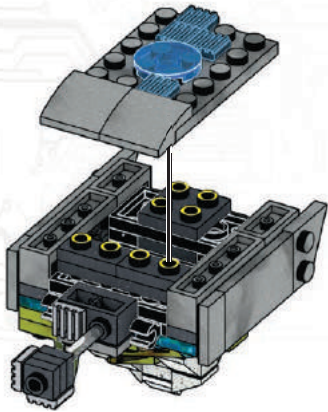
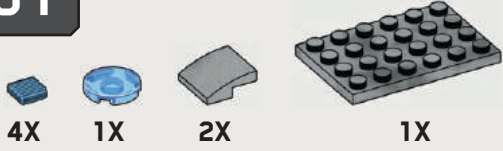

1

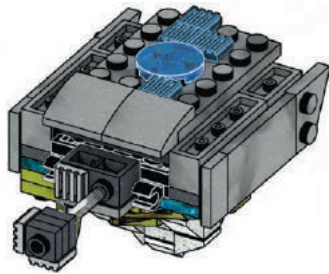

2

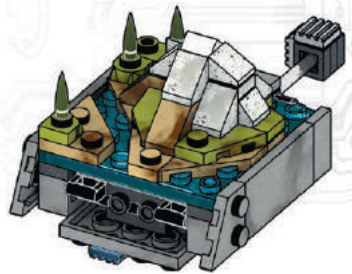

3



51

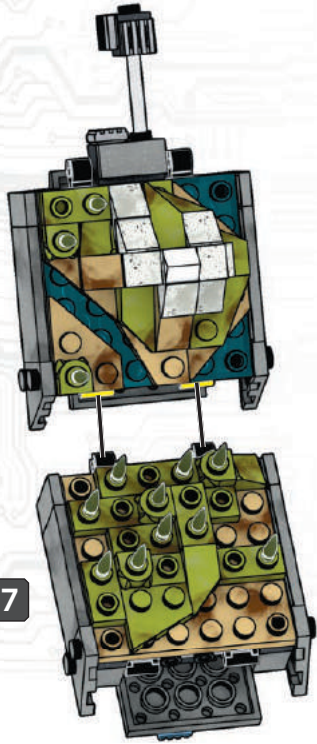

37

1

29

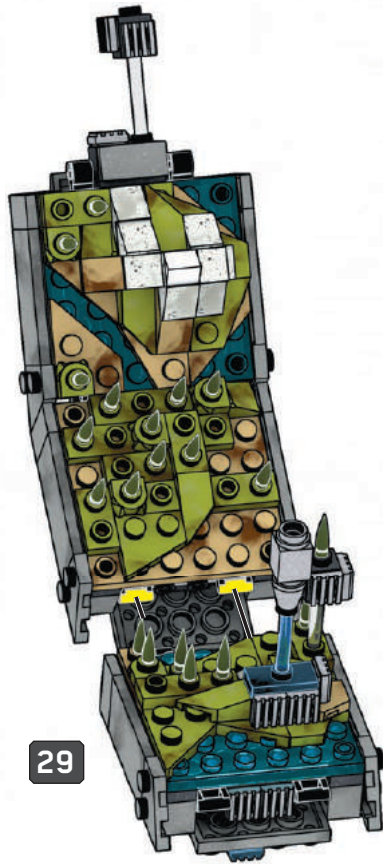

2

3

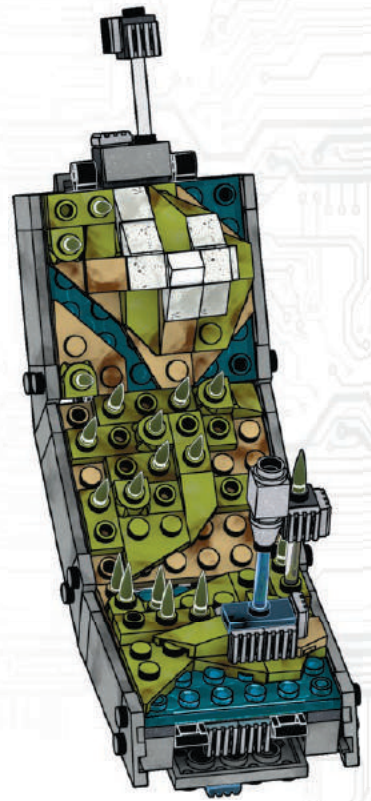

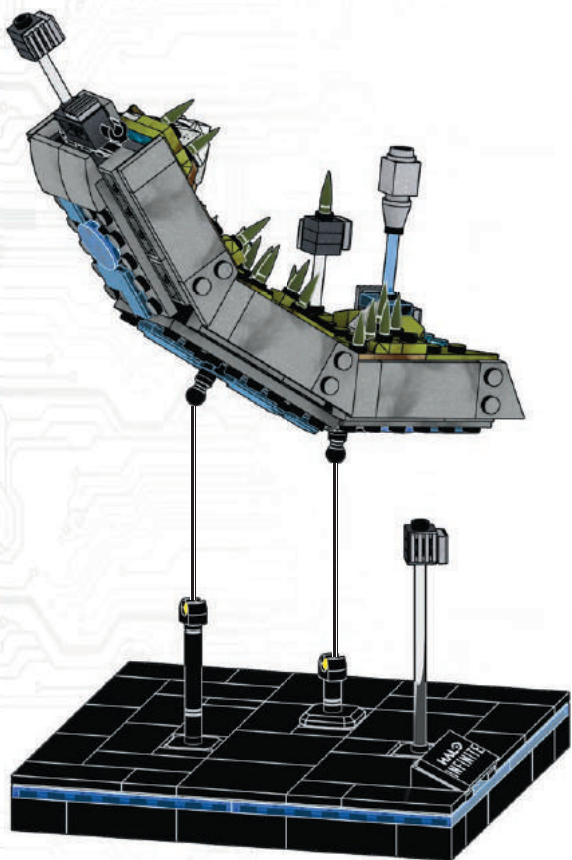

1

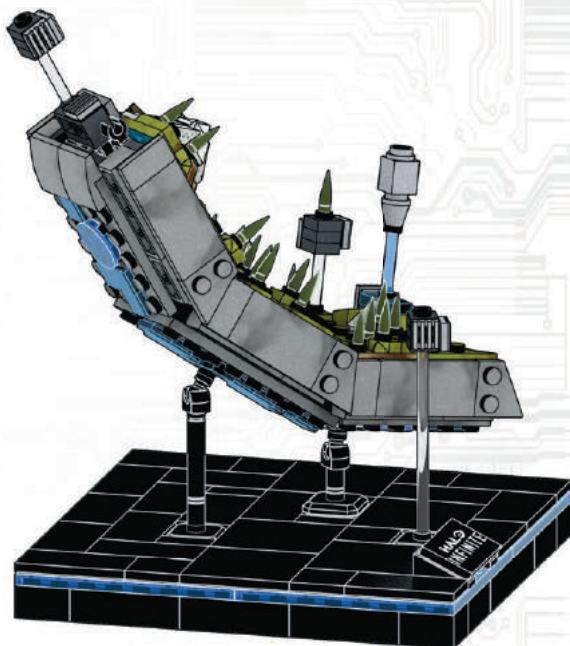

2

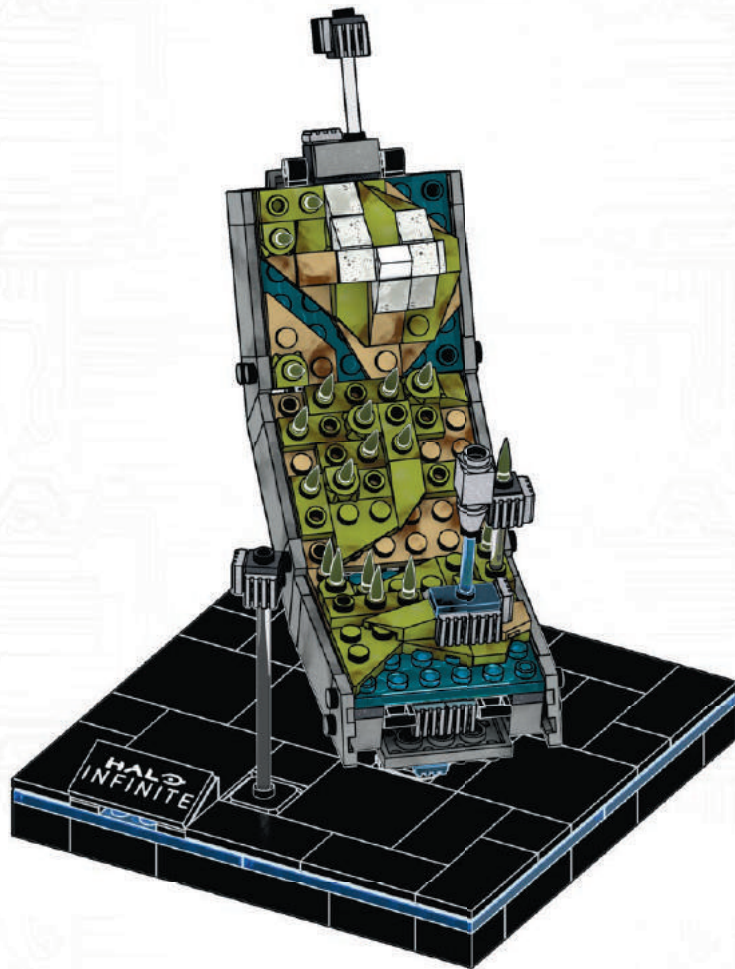

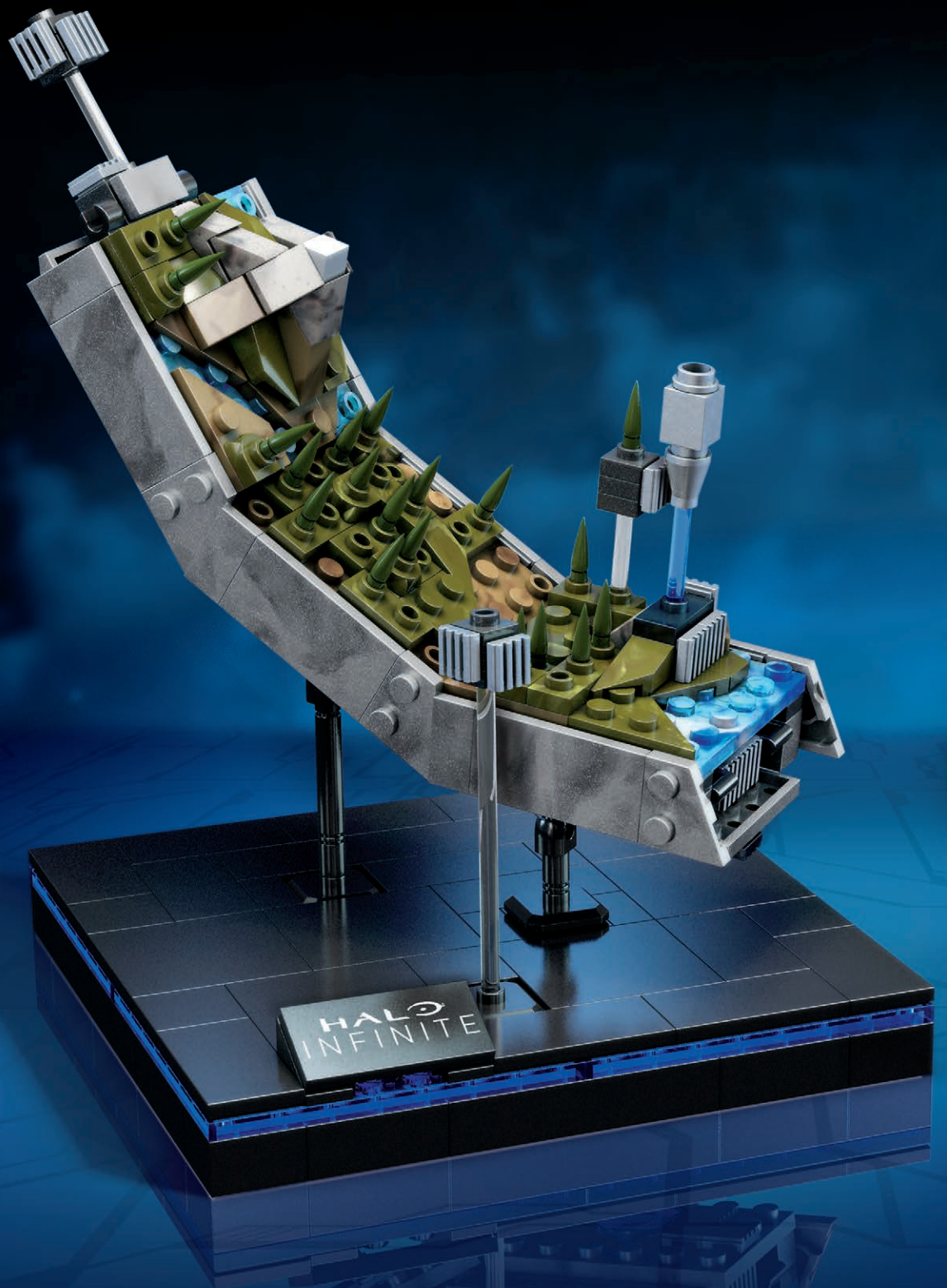

HALO  
INFINITE

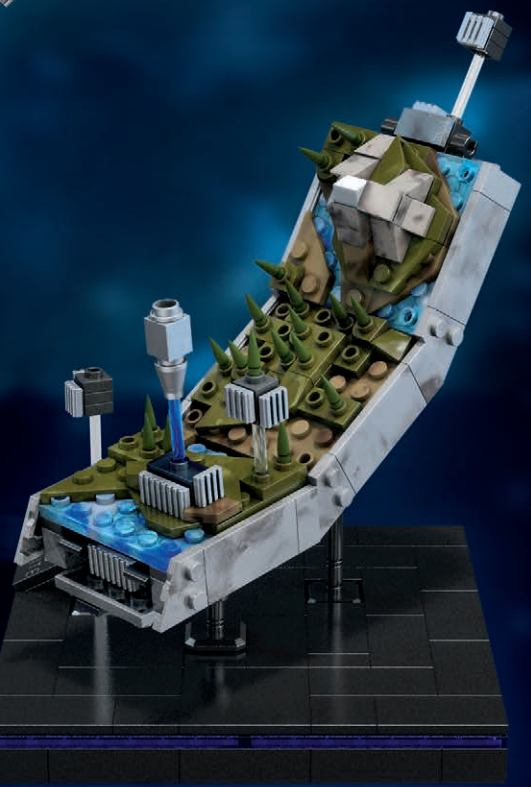

1X   
MA74397F

2X   
MA17003F

2X   
AM78291F

20X   
AM76659XN

1X   
MA18560APG

16X   
AM79666ALH

12X   
AM79666APG

4X   
MA03328MM

4X   
AM79590MM

3X   
MA77574MM

6X   
AM79376AJM

1X   
AM77901E

1X   
MA17127AQW

3X   
MA15258AQW

1X   
AM78296F

1X   
AM80485F

1X   
AM74299ANW

2X   
AM74300AJM

1X   
MA19530AQW

7X   
MA022501AKD

5X   
MA022501F

2X   
MA07590ALH

1X   
MA09393AQW

6X   
MA16680MM

8X   
AM79246MM

8X   
AM79246AJM

19X   
AM79070MM

6X   
MA76467MM

1X   
AM08412APG

2X   
MA1086APG

2X   
AM17130AJM

3X   
AM17129AJM

4X   
MA18740AQW

1X   
AM72494AJM

1X   
AM72495AJM

3X   
MA18665AJM

3X   
MA18665AKD

1X   
MA18666ANW

3X   
MA18666AKD

2X   
MA18666AJM

5X   
MA0948F

4X   
AM73009F

1X   
MA03773F

3X   
MA1146MM

2X   
AM02215HJ

2X   
MA04429F

2X   
MA1322ANW

1X   
MA17502MM

6X   
MA17502AKD

4X   
MA09023F

1X   
AM79355W

1X   
MA72233F

6X   
MA16954F

6X   
MA16975F

1X   
MA72600ANW

4X   
MA72600AJM

2X   
AM76206ANW

2X   
AM76205ANW

1X   
AM76205AJM

2X   
MA74106AKD

2X   
MA03873F

1X   
M76521W

1X   
M76521HJ

3X   
MA09593MM

3X   
AM77180F

3X   
AM18299F

2X   
MA09493AJM

3X   
MA09493F

6X   
AM77463AKD

16X   
AM77463F

1X   
AS-GRN05-01

6X   
MA17503AKD

10X   
MA09033F

5X   
AM78728F



1X  
MA17845AKD

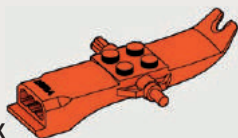

1X  
AM80855MCX



1X  
MA04983F



1X  
AM18259W



2X  
MA17055AKD

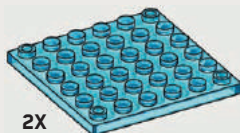

2X  
M74681ANJ



1X  
MA74681ANW

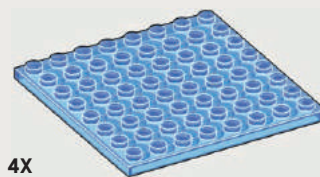

4X  
AM18556HJ



© 2020 Microsoft Corporation. All Rights Reserved. Microsoft, Halo, the Halo logo, Xbox, the Xbox logo, and 343 Industries are trademarks of the Microsoft group of companies.

Mattel Europa B.V., Gondel 1, 1186 MJ Amstelveen, Nederland. Mattel U.K. Limited, The Porter Building, 1 Brunel Way, Slough SL1 1FQ, UK. Mattel France, Parc de la Cerisaie, 1/3/5 allée des Fleurs, 94260 Fresnes Cedex. N° Cristal 0969 36 99 99 (Numéro non surtaxé) ou www.lesjouetsmattel.fr Mattel Belgium, Trade Mart, Atomiumsquare, Bogota 202 - B 275, 1020 Brussels. Grátis nummer België: 0800 - 16 936 - Grátis nummer Luxemburg: 800 - 22 784 - Grátis nummer Nederland: 0800 - 262 88 35. Deutschland: Mattel GmbH, Solmsstraße 4, D-60486 Frankfurt am Main. Schweiz: Mattel AG, Kirchstrasse 24, CH-3097 Liebefeld. Österreich: Mattel Ges.m.b.H., Campus 21, Liebermannstraße A01 404, A- 2345 Brunn/Gebrige. Mattel Italy Srl, Via Bracco, 6-MAC 6, 20159 Milano, Italy. Servizio assistenza clienti: Customers.italia@mattel.com - Numero verde 800 11 37 11. Mattel España, S.A., Aribau 200, 08036 Barcelona. cservicio.spain@mattel.com Tel: 902203010 http://www.servicio.mattel.com/es. Mattel East Asia Ltd., Room 503-09, North Tower, World Finance Centre, Harbour City, Tsimshatsui, HK, China. Tel.: (852) 3185-6500. Diimport & Diedarkan Oleh: Mattel Continental Asia Sdn Bhd. Level 19, Tower 3, Avenue 7, No. 8 Jalan Kerinci, Bangsar South, 59200 Kuala Lumpur, Malaysia. Mattel South Africa (PTY) LTD, Office 102 B, 30 Melrose Boulevard, Johannesburg 2196. Dystrybutor: Mattel Poland Sp. z o.o., Warsaw Trade Tower 34 p., ul. Chłodna 51, 00-967 Warszawa. Mattel Australia Pty Ltd., 658 Church St., Richmond, Victoria, 3121. Consumer Advisory Service - 1300 135 312. Mattel AEBE, Eбвoдчyю Moдaлoбy 1, Kpяпю K-2, TK 17561, Пoлaдo Oбщпo. Mattel Oyuncakçılık Tic. Ltd. Şti. İçerenköy Mah., Erkut Sok. A Blok No:12 Üner Plaza Kat:9-10 34752 Ataşehir İstanbul. Tel: 0216 570 75 00. Импoртep/Упoлнoмoчeнная oргaнизaция: OOO "MATEЛ" Poccийcкая Фeдepaция, 105120 Mockвa, 2-й Cыpoмятннчecкий пepeпoк; +7 495 287 19 39. Forg: Mattel Toys Hungary Kft 1139 Budapest Váci út 91, +36 1 270 0223. Mattel Czech Republic s.r.o., The Forum, Václavské nám. 19, 11000 Praha1. Mattel, Inc. 636 Girard Avenue, East Aurora, NY 14052. U.S.A. Mattel Canada Inc., Mississauga, Ontario L8R 3W2. Consumer Services: You may call us free at/ Composez sans frais le 1-800-524-8697. Importado y distribuido por Mattel de México, S.A. de C.V., Miguel de Cervantes Saavedra No. 193, Pisos 10 y 11, Col. Granada, Alcatida Miguel Hidalgo, C.P. 11520, México, Ciudad de México. R.F.C. MME-920701-NB3. Tels: 59-05-51-00 Ext.5206 ó 01-800-463-59-89. Mattel Chile, S.A., Avenida Américo Vespucio 501-B, Quilicura, Santiago. Tel.: 1230-020-6213. Servicio al consumidor Venezuela: Tel.: 0-800-100-9123. Mattel Argentina, S.A., Av. Libertador 1000, Piso 11 - Oficinas 109 y 111, Vicente López - Prov. Buenos Aires. Tel.: 0800-666-3373. Mattel Colombia, S.A., Calle 123#7-07 P5, Bogotá. Tel.: 01800-710-2069. Mattel Perú, S.A., Av. Juan de Arona # 151, Centro Empresarial Juan de Arona, Torre C, Piso 7, Oficina 704, San Isidro, Lima 27, Perú. RUC: 20425853865. Reg. Importador: 02350-12-JUE-DIGESA. Tel.: 0800-54744. E-mail Latinoamerica: servicio.clientes@mattel.com. Mattel do Brasil Ltda. - CNPJ : 54.558.002/0001-20 - Rua Verbo Divino, 1488 - 2º. Andar - 04719-904 - Chácara Santo Antônio - São Paulo - SP - Brasil. Serviço de Atendimento ao Consumidor: fone 0800-550780. E-mail: sac.matteldobrazil@mattel.com



# HALO

**MORE TO COLLECT!  
ENCORE PLUS À COLLECTIONNER!  
MÁS PARA COLECCIONAR!  
MAIS PARA COLECIONAR!  
MEHR ZUMSAMMELN!  
СОБЕРИ БОЛЬШЕ!**



GVN33



GPB05



**BUILD & SHARE**  
**CONSTRUIRE ET PARTAGER**  
CONSTRUYE Y COMPARTE | MONTAR E  
COMPARTILHAR | BAUEN UND MIT  
ANDEREN TEILEN | СОЗДАВАЙ И ДЕЛИСЬ  
[megaconstrux.com](http://megaconstrux.com)

Each sold separately and subject to availability. / Produits vendus séparément, selon la disponibilité.  
/ Se venden por separado y están sujetos a disponibilidad. / Vendidos em separado e sujeitos à  
disponibilidade. / Ognuno in vendita separatamente secondo disponibilità. / Alle Artikel separat  
erhältlich. Einige Artikel werden nicht in allen Ländern vertrieben. / Sprzedawane oddzielnie w  
zależności od dostępności. / Per stuk verkrijgbaar en niet overal leverbaar. / Каждый продукт  
продается отдельно, в зависимости от наличия. / Sælges separat og så længe lager haves. / Alla  
delar säljs separat så långt lagret räcker. / Hver leke selges separat så langt lageret rekker. / Jokainen  
myydään erikseen, saatavuus voi vaihdella. / Το καθένα πωλείται ξεχωριστά και ανάλογα με τη  
διαθεσιμότητα. / Her biri ayrı ayrı ve stoklara bağlı olarak satılır. / Každá hračka se prodává  
samostatně dle aktuální nabídky. / Každé sa predáva samostatne a podľa dostupnosti. / Mindegyik  
külön kapható, elérhetőségük változhat. / それぞれ在庫状況に従って個別に販売されます。  
تباع كل منها على حدة وتخضع لتوفره.

每件单独出售，并且视库存情况而定。



MIX  
Paper from responsible sources  
Papier issu de sources responsables  
FSC® C011825



© D781,964, D797,203, D841,101,  
D834,105

1186 MJ, 1, NL

©2020, MEGA Brands Inc. &™ MEGA Brands Inc. CONSTRUX™ is owned by Mattel and used under license. CONSTRUX™ appartient à Mattel et est utilisée sous licence. Printed in Canada / Imprimé au Canada

D-GRN05-01

MEGA Brands Inc. Montreal QC H4T 1K4 Canada  
MADE IN CANADA WITH DOMESTIC AND IMPORTED COMPONENTS. FABRIQUÉ AU CANADA AVEC DES COMPOSANTS DOMESTIQUES ET IMPORTÉS.  
FABRICADO NO CANADÁ COM COMPONENTES CANADIANOS E IMPORTADOS. FABRICADO EN CANADÁ CON PIEZAS FABRICADAS EN CANADÁ  
Y PIEZAS IMPORTADAS. ИЗГОТОВЛЕНО В КАНАДЕ С ОТЕЧЕСТВЕННЫМИ И ИМПОРТНЫМИ КОМПОНЕНТАМИ.  
YERLI VE İTHAL PARÇALARLA KANADA'DA ÜRETİLMİŞTİR. صنع في كندا من مواد محلية ومستوردة.