

**MEGA
CONSTRUX™**

POKÉMON™



Build it!
constrúis-Lo!
¡constrúyelo!

**BULBASAUUR
BULBIZARRE
BISASAM**



**WONDER
BUILDERS™**
GVK83





Fuel their imagination with building toys that support creative thinking and problem solving.

Stimulez leur imagination avec des jouets de construction qui encouragent l'esprit créatif et la résolution de problèmes.

Alimenta su imaginación con juguetes de construcción que ayudan a desarrollar el ensamiento creativo y la resolución de problemas. / Abasteça a imaginação dele com brinquedos de montar que suportam o pensamento criativo e a resolução de problemas. / Dieses Bauspielzeug beflügelt nicht nur die Phantasie, sondern unterstützt auch kreatives und lösungsorientiertes Denken. / Разжигайте воображение детей с помощью конструктора, развивающего творческие способности и логическое мышление.



Authentic details Détails authentiques

Detalles auténticos
Detalhes autênticos
Authentische Details
Реалистичные детали



Different sizes to build Différentes tailles à construire

Tamanhos diferentes para construir
Verschiedene Größen zum Bauen
Se pueden crear en distintos tamaños
Модели для сборки разных размеров

Learn more
Pour en savoir plus

Más información · Sabe mais · Weitere
Infos gibt es auf · Узнать большез

play.megaconstrux.com

MEGA
CONSTRUX



Scan here for
instructions

Scanner ici
pour obtenir les
instructions

Escanee aquí para
obtener instrucciones

Digitalize aqui
para instruções

Hier scannen und
Anleitung aufrufen

Просканируйтездесь
для получения
инструкций

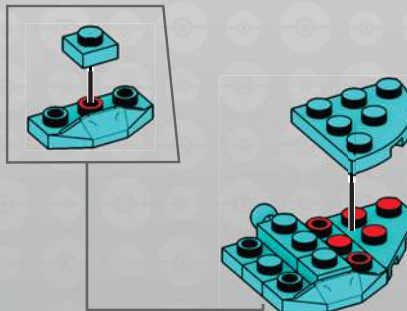
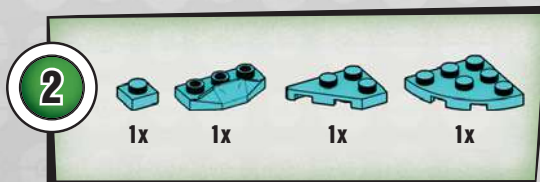
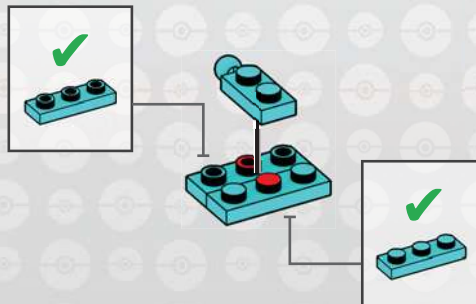

3

1x 1x

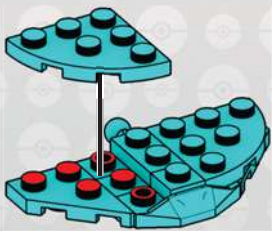

4

2x 1x

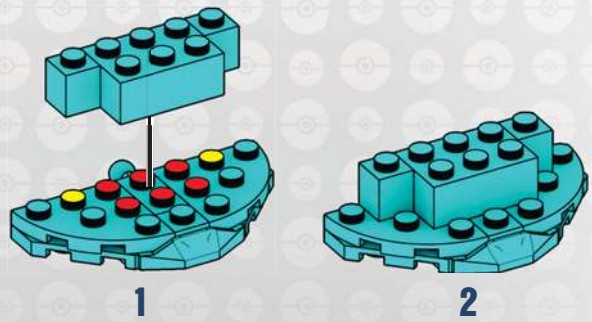

5

1x 1x 1x

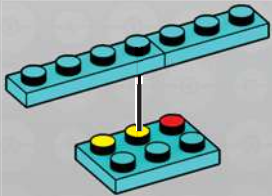

6

1x 1x

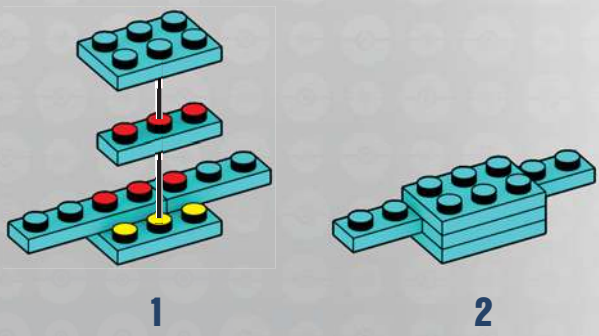

7



2x



2x



10



1x



1x



1x

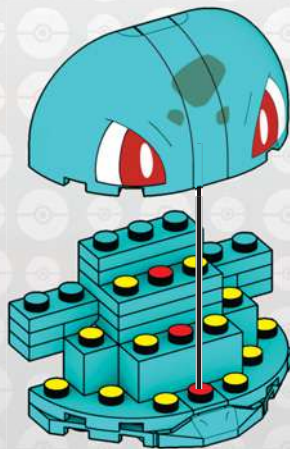

11



4x



2x

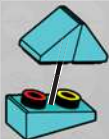

1



2

x2

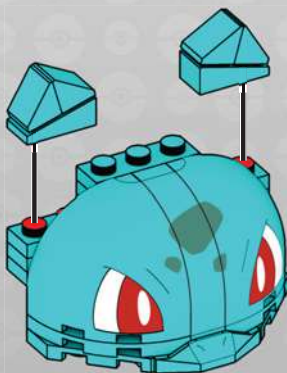

1

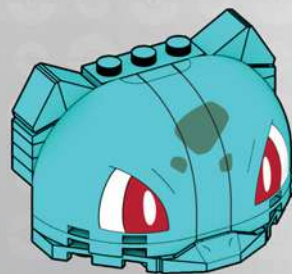

2

12



2x

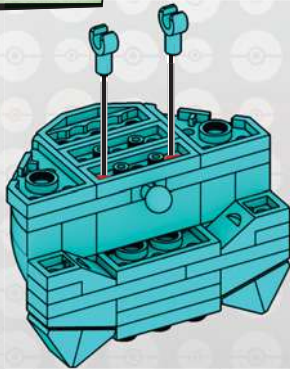

13



2x



2x



1x

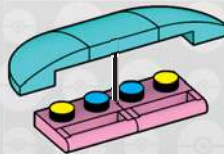

1



2

14

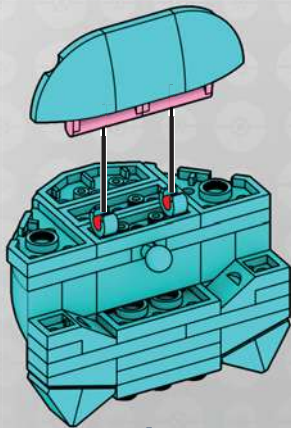

1

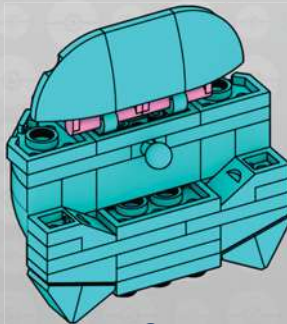

2

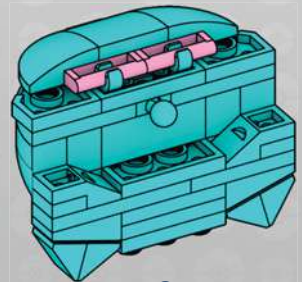

3

15



16

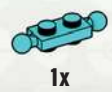

1



2

17

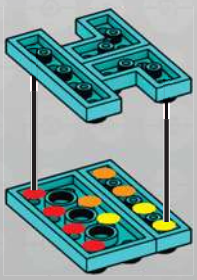
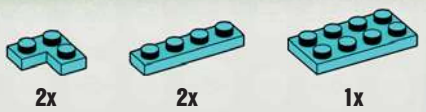

18

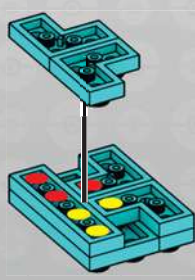

1

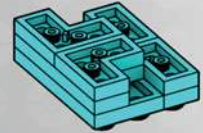

2

19

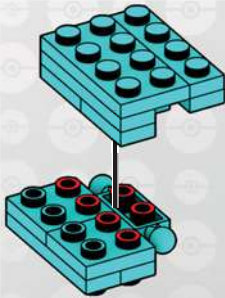

20

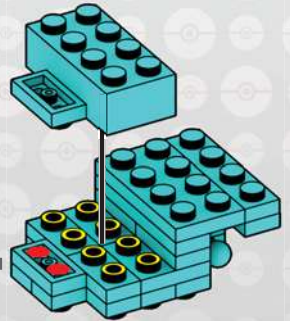
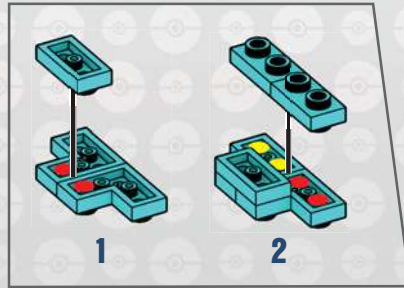

21

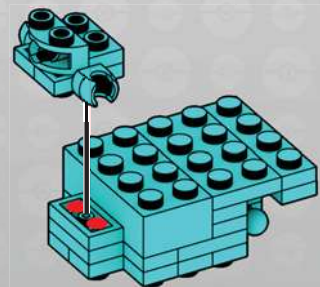
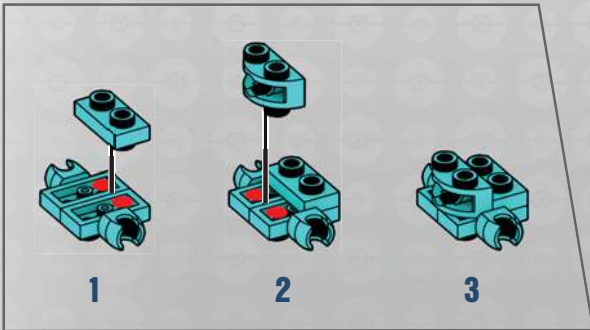

22



2x



2x

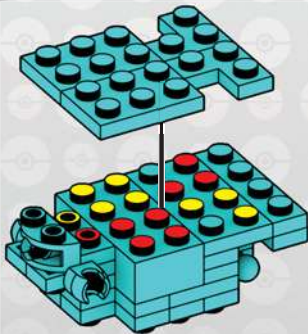

1

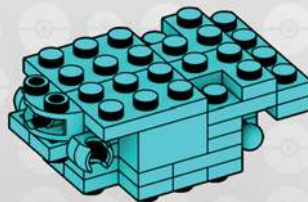

2

23



2x

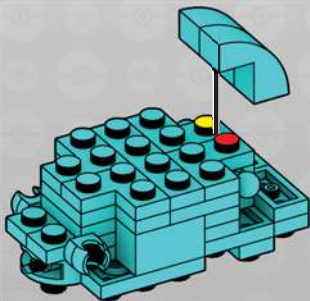

24



2x

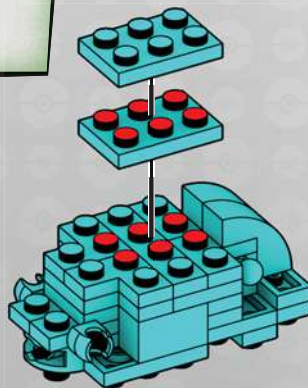

25

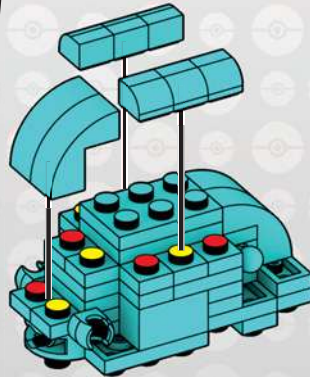
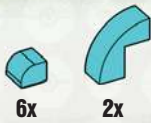

1

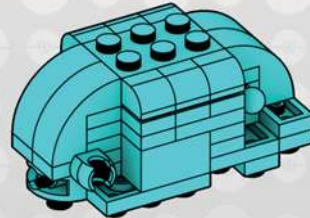

2

26

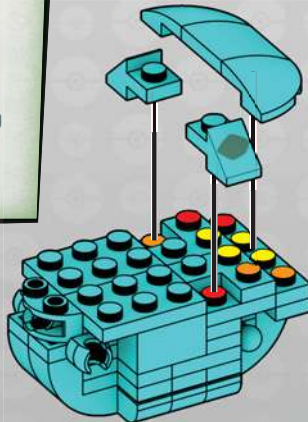
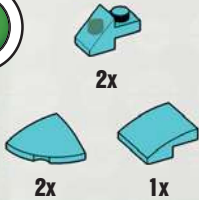

27

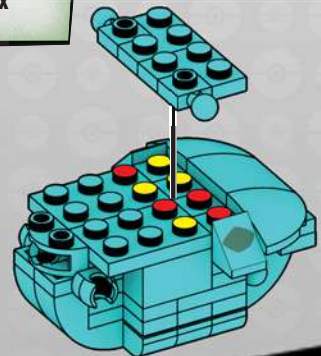

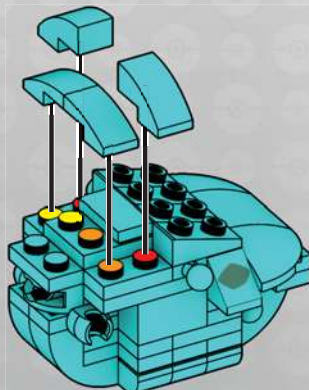
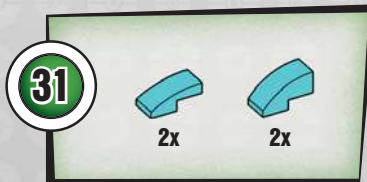
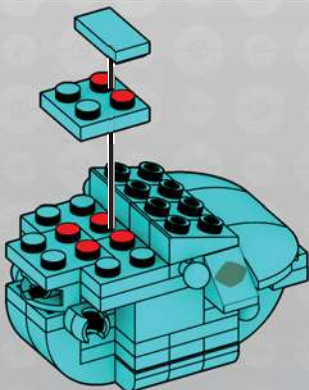
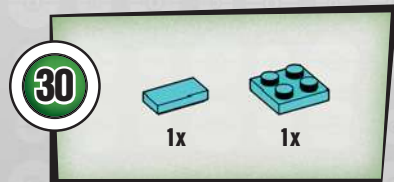
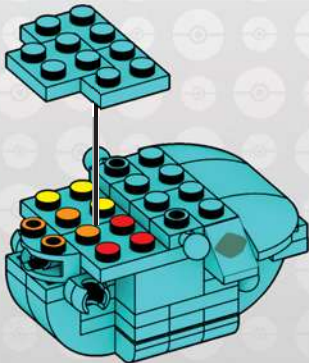

32

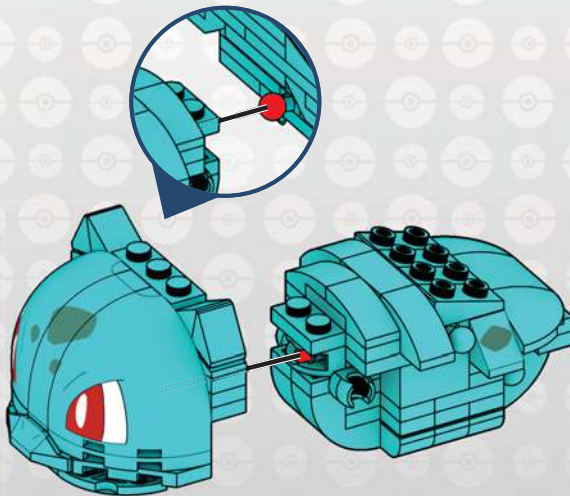

1

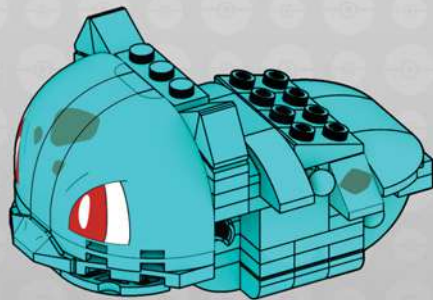

2

33



1x



1x



1x



1x



34



1x



1x



1x



1



2

35



1x



1x



1x



1x



36



1x



1x



1x



1



2

37

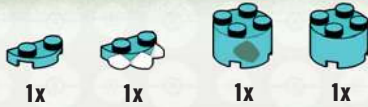

38



39



40

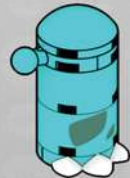
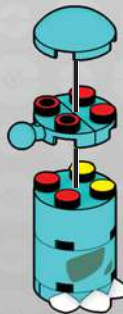

41

38



34

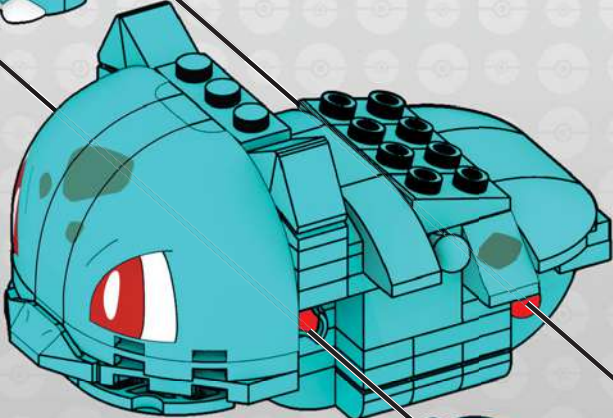

40

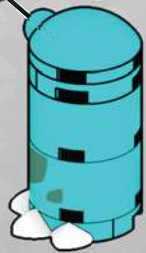

36



1

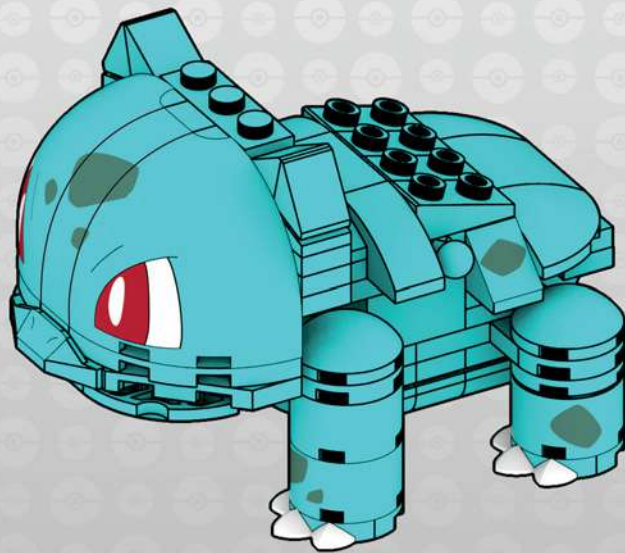

2

42

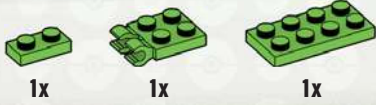

43

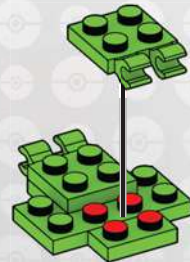
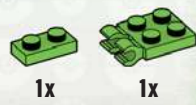

44

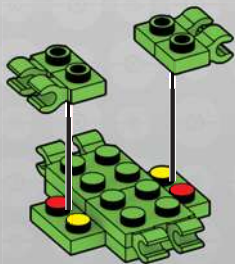

45

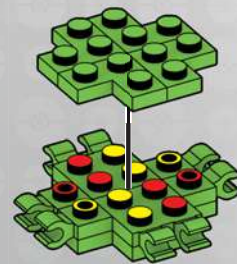

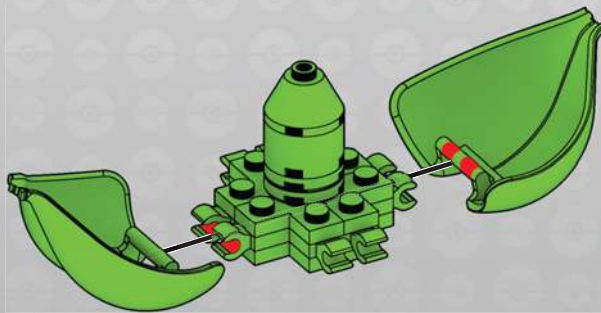
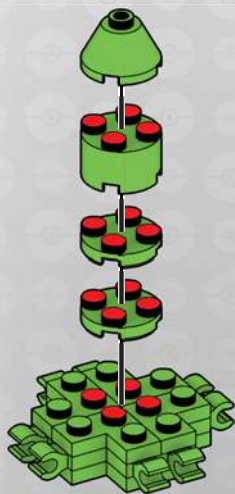
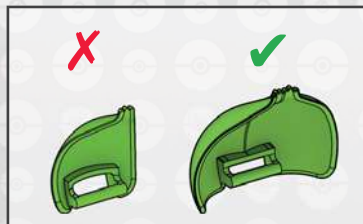
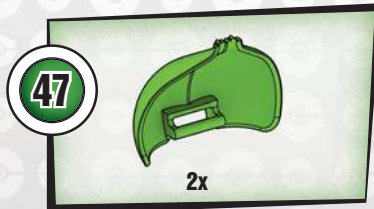

48



2x

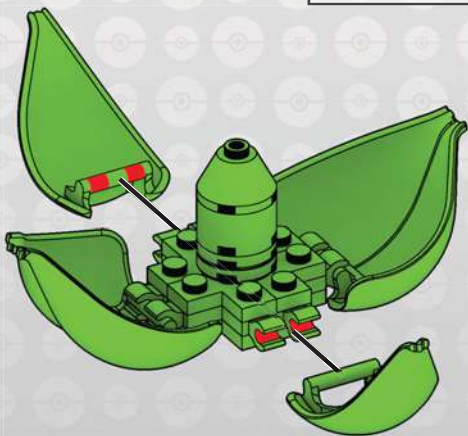

1

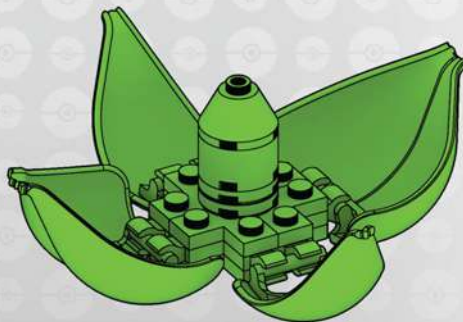

2

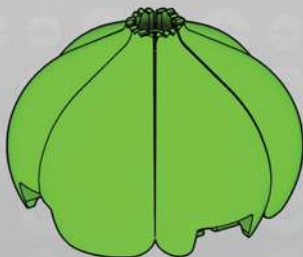

3

49

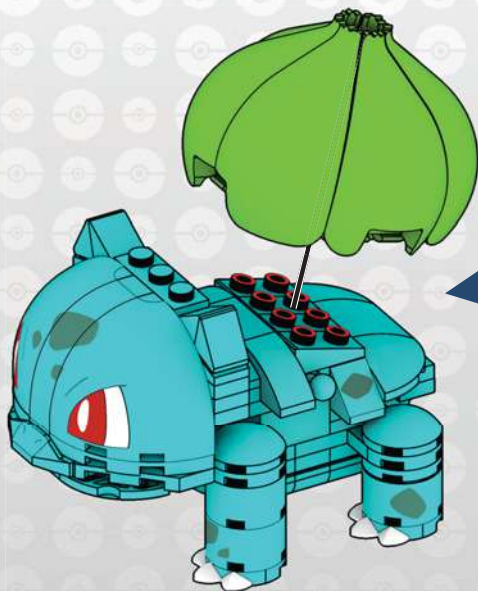

1

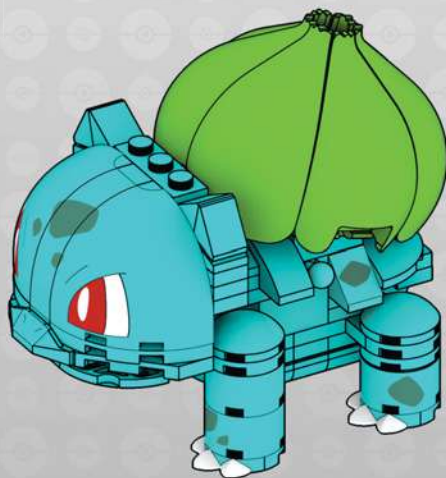
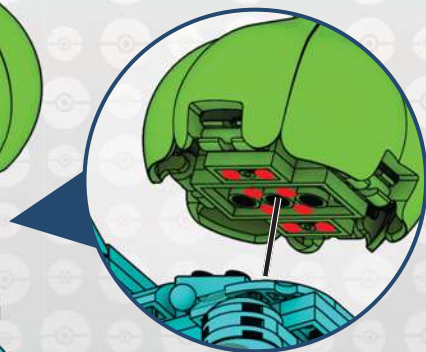

2

50



8x

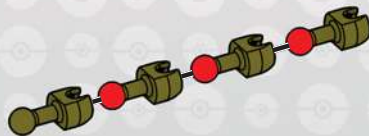

x2

51



8x

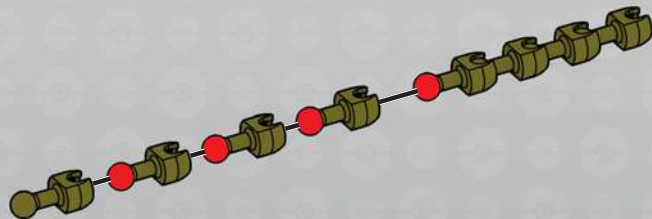

x2

52



2x



2x



2x

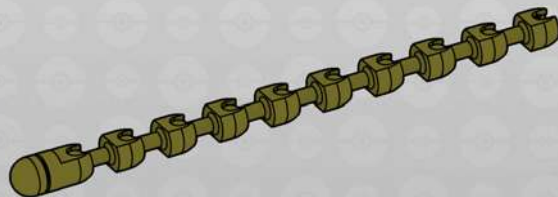
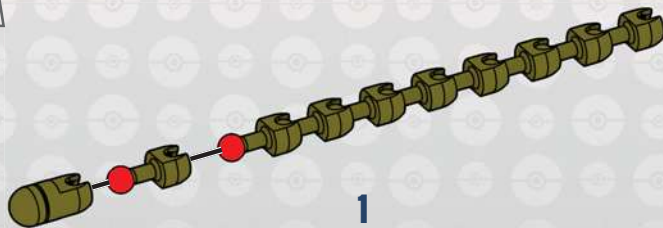
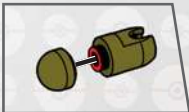

x2

53

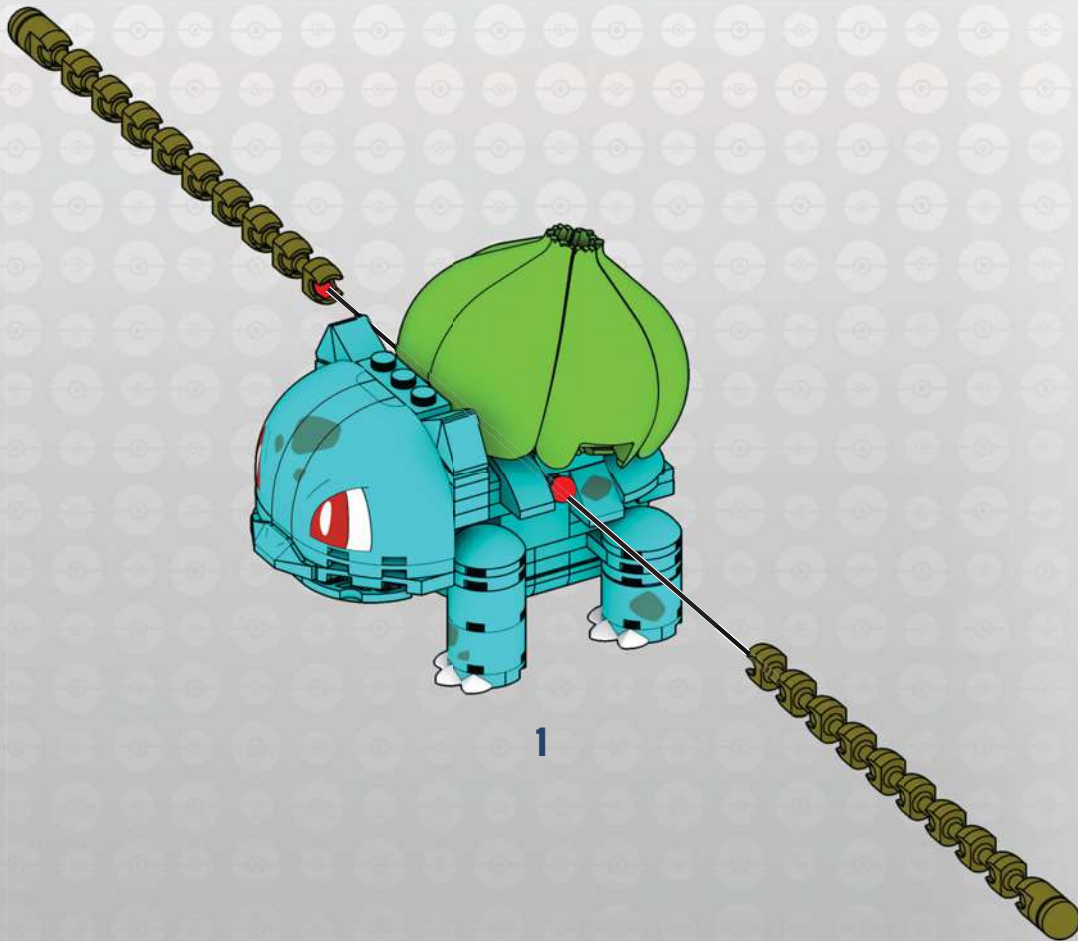

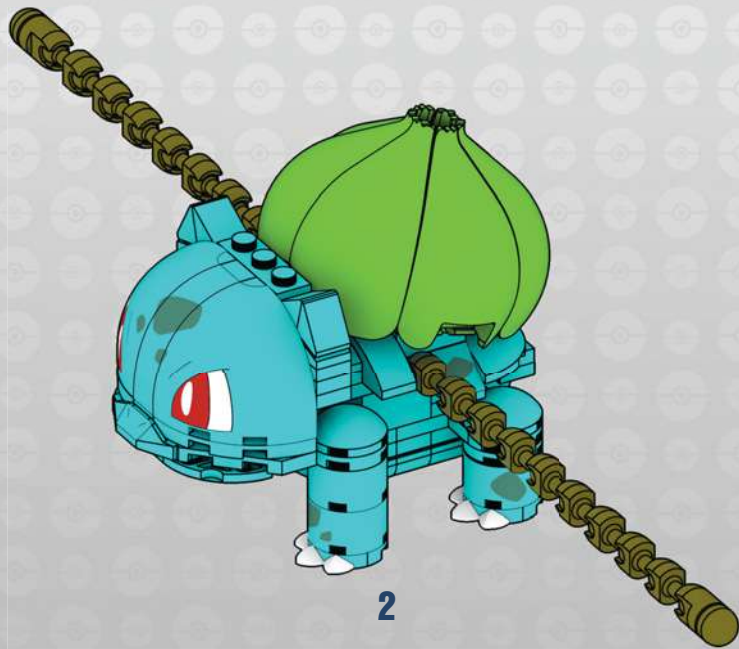

2



3

BULBASAUUR BULBIZARRE BISASAM



1



2

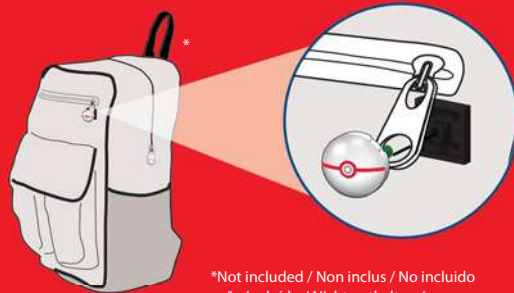

*Not included / Non inclus / No incluido
não incluido / Nicht enthalten / не входит

**BUILD THEM!
CONSTRUIJS-LES!
¡CONSTRUYELOS!
ΚΑΤΑΣΚΕΥΗ! • ПОСТРОИ!**



Set(s) sold separately and subject to availability. / Ensemble(s) vendu(s) séparément. Certains produits peuvent ne pas être commercialisés. / Se vende(n) por separado y está(n) sujeto(s) a disponibilidad. / Conjunto(s) vendido(s) em separado e sujeito(s) à disponibilidade. / Set in vendita separatamente, secondo disponibilità. / Das/Die Set(s) sind separat erhältlich. / Zestaw(y) sprzedawany(e) oddzielnie w zależności od dostępności. / Set(s) apart verkrijgbaar en afhankelijk van beschikbaarheid. / Набор(-ы) продаются отдельно, при наличии. / Sæt sælges separat og så længe lager haves. / Seten säljs separat så länge lagret räcker. / Settet/settene selges separat så langt lageret rekker. / Pakkaus/pakkaukset myydään erikseen, saatavuus voi



COMING SOON • BIENTÔT DISPONIBLE
DISPONIBLE PROXIMAMENTE • EM BREVE
BALD ERHÄLTlich • CKOPO

vaihdella. / Το(α) σετ πωλούνται ξεχωριστά και ανάλογα με τη διαθεσιμότητα. / Setler ayrı olarak satılır ve stoklarla sınırlıdır. / Set (sety) se prodává (prodávají) samostatně dle aktuální nabídky. / Súprava/-y sa predáva(jú) samostatne a podľa dostupnosti. / A készlet(ek) külön kapható(k), az elérhetőség változhat. / セット商品は別売りになります。在庫状況は別途ご確認をお願いします。 / تباع المجموعة أو المجموعات على حدة وتخضع لتوافرها. /

每套单独发售，按供货情况决定。

2x
MA17062ASU

2x
AM78219RL

3x
MA03328ASU

6x
MA17787ASU

2x
AM78275RL

4x
MA15258ASU

2x
MA1086ASU

2x
AM79377ASU

4x
MA74415HT

18x
AM78290RL

8x
AM79375ASU

1x
MA022501ASU

2x
MA09393ASU

2x
MA09393HT

3x
MA16680ASU

4x
AM78277ASU

2x
AM80011ASU

2x
MA72002ASU

2x
AM78486ASU

1x
AM78281ASU

1x
AM78276ASU

6x
AM80573ASU

4x
AS-GVK83-05

2x
AS-GVK83-09

2x
MA72000ASX

14x
MA15484ASU

4x
MA15484HT

2x
MA74677ASU

2x
MA74677HT

1x
AM79018E

4x
AM78285ASU

1x
AS-GVK83-08

1x
MA1404HT

2x
MA03773ASU

1x
AM79017F

2x
MA1146ASU

2x
AS-GVK83-06

2x
AS-GVK83-07

2x
MA1320ASU

1x
MA1320HT

2x
MA17788ASU

4x
MA16682ASU

4x
MA76525ASU

2x
MA74106ASU

1x
AM76206ASU

1x
AM76205ASU

2x
MA18328HT

1x
MA72600ASU

5x
MA1314ASU

1x
AM78412ASU

1x
AS-GVK83-04

6x
MA03772ASU

1x
MA03873ASU

2x
MA17056ASU

1x
AS-GVK83-02

2x
AM81015HT

4x
MA09593ASU

1x
MA09493ASU

1x
MA09493HT

1x
MA09033ASU

1x
AS-GVK83-01

1x
AS-GVK83-03

2x
AM81016HT

**Missing pieces?
Pièces manquantes?**

¿Partes faltantes? - Perdeu peças?
Fehlende Teile? - Не хватает деталей?

support.megabrands.com

⚠ WARNING:
CHOKING HAZARD. - Small parts.
Not for children under 3 years.

⚠ ATTENTION:
DANGER D'ÉTOUFFEMENT. - Présence de petits éléments.
Ne convient pas aux enfants de moins de 3 ans.

⚠ 警告:
のどにつまる危険 小さな部品が含まれています
3歳以下の子供には与えないで下さい。

غير مناسبة للأطفال دون 36 شهراً - قطع صغيرة.
تحذير ⚠

⚠ **警告!**
不适合3岁以下儿童使用。
内含小零件。

ADVERTENCIA: PELIGRO DE ATRAGANTAMIENTO. Juguete no recomendado para menores de 3 años, porque contiene piezas pequeñas que podrían provocar asfixia en caso de ser ingeridas o inhaladas por el/ la niño/a.

ATENÇÃO! NÃO INDICADO / NÃO RECOMENDÁVEL PARA CRIANÇAS MENORES DE 3 (TRÊS) ANOS POR CONTER PARTE(S) PEQUENA(S) QUE PODE(M) SER ENGOLIDA(S) OU ASPIRADA(S) PODENDO PROVOCAR ASFIXIA.

AVVERTENZA: Contiene pezzi di piccole dimensioni.
ACHTUNG: Kleine Teile.

OSTRZEŻENIE: Małe części. Niebezpieczeństwo zadławienia.

WAARSCHUWING: Kleine onderdelen
ПРЕДУПРЕЖДЕНИЕ: Мелкие детали.

ADVARSEL: Indeholder små dele.

WARNING: Smådelar

ADVARSEL: Små deler

VAROITUS: Pieniä osia

ΠΡΟΣΟΧΗ: Περιλαμβάνονται μικρά κομμάτια.

UYARI: Küçük parçalar.

UPOZORNĚNÍ: Malé díly

UPOZORNENIE: Malé časti

FIGYELMEZTETÉS: Kis alkatrészek.



Mattel Europa B.V., Gondel 1, 1186 MJ Amstelveen, Nederland. Mattel U.K. Limited, The Porter Building, 1 Brunel Way, Slough SL1 1FQ, UK. Mattel France, Parc de la Cerisaie, 1/3/5 allée des Fleurs, 94260 Fresnes Cedex. N° Cristal 0969 36 99 99 (Numéro non surtaxé) ou www.lesjouetsmattel.fr Mattel Belgium, Trade Mart, Atomiumsquare, Bogota 202 - B 275, 1020 Brussels. Gratis nummer België: 0800 - 16 936 - Gratis nummer Luxemburg: 800 - 22 784 - Gratis nummer Nederland: 0800 - 262 88 35. Deutschland: Mattel GmbH, Solmsstraße 4, D-60486 Frankfurt am Main. Schweiz: Mattel AG, Kirchstrasse 24, CH-3097 Liebefeld. Österreich: Mattel Ges.m.b.H., Campus 21, Liebermanstraße A01 404, A- 2345 Brunn/Gebirge. Mattel Italy Srl, Via Bracco, 6-MAC 6, 20159 Milano, Italy. Servizio assistenza clienti: Customersrv.italia@mattel.com - Numero verde 800 11 37 11. Mattel España, S.A., Aribau 200, 08036 Barcelona. cservice.spain@mattel.com Tel: 902203010 http://www.service.mattel.com/es. Mattel East Asia Ltd., Room 503-09, North Tower, World Finance Centre, Harbour City, Tsinghsatui, HK, China. Tel: (852) 3185-6500. Diimport & Diedarkan Oleh: Mattel Continental Asia Sdn Bhd. Level 19, Tower 3, Avenue 7, No. 8 Jalan Kerinchi, Bangsar South, 59200 Kuala Lumpur, Malaysia. Mattel South Africa (PTY) LTD, Office 102 13, 30 Melrose Boulevard, Johannesburg 2196. Dystrybutor: Mattel Poland Sp. z o.o., Warsaw Trade Tower 34 p., ul. Chłodna 51, 00-867 Warszawa. Mattel Australia Pty. Ltd., 658 Church St., Richmond, Victoria, 3121. Consumer Advisory Service - 1300 135 312. Mattel AEBE, Εθνάρχου Μακαρίου 1, κτήριο Κ-2, ΤΚ 17561, Παλαιό Φάληρο. Mattel Oyuncakçılık Tic. Ltd. Şti. İerenköy Mah., Erku Sok. A Blok No:12 Üner Plaza Kat:9-10 34752 Ataşehir İstanbul. Tel: 0216 570 75 00. Импортёр/Уполномоченная организация: ООО "МАТТЕЛ" Российская Федерация, 105120 Москва, 2-й Сыромлининский переулок, 1; +7 495 287 79 39. Forg.: Mattel Toys Hungary Kft 1139 Budapest Váci út 91. +36 1 270 0223. Mattel Czech Republic s.r.o., The Forum, Václavské nám. 19, 11000 Praha 1. Mattel, Inc. 636 Girard Avenue, East Aurora, NY 14052, U.S.A. Mattel Canada Inc., Mississauga, Ontario L5R 3W2. Consumer Services: You may call us free at / Composez sans frais le 1-800-524-8697. Importado y distribuido por Mattel de México, S.A. de C.V., Miquel de Cervantes Saavedra No. 193, Pisos 10 y 11, Col. Granada, Alcaldía Miguel Hidalgo, CP. 11520, México, Ciudad de México. R.F.C. MME-920701-NB3. Tels: 59-05-51-00 Ext. 5206 ó 01-800-463-59-89. Mattel Chile, S.A., Avenida América Vespucio 501-B, Quilicura, Santiago. Tel.: 1230-020-6213. Servicio al consumidor Venezuela: Tel: 0-800-100-9123. Mattel Argentina, S.A., Av. Libertador 1000, Piso 11 - Oficinas 109 y 111, Vicente López - Prov. Buenos Aires. Tel.: 0800-666-3373. Mattel Colombia, S.A., Calle 123#7-07 P5, Bogotá. Tel.: 01800-710-2069. Mattel Perú, S.A., Av. Juan de Arona # 151, Centro Empresarial Juan de Arona, Torre C, Piso 7, Oficina 704, San Isidro, Lima 27, Perú. RUC: 20425853865. Reg. Importador: 02350-12-JUE-DIGESA. Tel.: 0800-54744. E-mail Latinoamérica: servicio.clientes@mattel.com. Mattel do Brasil Ltda. - Rua Verbo Divino, 1488 - 2ª. Andar - 04719-904 - Chácara Santo Antônio - São Paulo - SP - Brasil. Serviço de Atendimento ao Consumidor: fone 0800-550780. E-mail: sac.mattel@brasil.mattel.com

Ⓟ D799,607, D834,105

©2020 Pokémon. ©1995–2020 Nintendo / Creatures Inc. / GAME FREAK inc.
TM, ®, and character names are trademarks of Nintendo.

©2020 Pokémon. ©1995–2020 Nintendo/Creatures Inc./GAME FREAK inc.
TM, ® et les noms des personnages sont des marques de Nintendo.

MEGA
CONSTRUX™

POKÉMON™

10+
PRO
BUILDERS™

MORE TO BUILD! / ENCORE PLUS À CONSTRUIRE!
¡MÁS PARA CONSTRUIR! / MAIS PARA CONSTRUIR!
MEHR ZUM BAUEN! / СОБЕРИ ИХ ВСЕХ!



Are you ready for
the next challenge?
Prêt pour le prochain défi?

¿Estás listo para el siguiente desafío?
Você está pronto para o próximo desafio?
Bist du bereit für die nächste Herausforderung?
Вы готовы к следующему испытанию?



Set(s) sold separately and subject to availability. / Ensemble(s) vendu(s) séparément. Certains produits peuvent ne pas être commercialisés. / Se vende(n) por separado y está(n) sujeto(s) a disponibilidad. / Conjunto(s) vendido(s) em separado e sujeito(s) à disponibilidade. / Set in vendita separatamente, secondo disponibilità. Das/Die Set(s) sind separat erhältlich. / Zestaw(y) sprzedawany(e) oddzielnie w zależności od dostępności. Set(s) apart verkrijgbaar en afhankelijk van beschikbaarheid. / Набор(-ы) продаются отдельно, при наличии. / Sæt sælges separat og så længe lager haves. / Seten säljs separat så länge lagret räcker. / Sættet/settene selges separat så langt lageret rekker. / Pakkaus/pakkaukset myydään erikseen, saatavuus voi vaihdella. / To(oi) set πωλούνται ξεχωριστά και ανάλογα με τη διαθεσιμότητα. / Setler ayrı olarak satılır ve stoklarla sınırlıdır. / Set (sety) se prodává (prodávají) samostatně dle aktuální nabídky. / Súprava-/y sa predáva(jú) samostatne a podľa dostupnosti. / A készlet(ek) külön kapható(k), az elérhetőség változhat. / セット商品は別売りになります。在庫状況は別途ご確認をお願いします。 / تباع المجموعة أو المجموعات على حدة وتخضع لتوافرها.

每套单独发售，按供货情况决定。

MEGA Brands Inc. Montreal QC H4T 1K4 Canada
MADE IN CANADA WITH DOMESTIC AND IMPORTED COMPONENTS.
FABRIQUÉ AU CANADA AVEC DES COMPOSANTS DOMESTIQUES ET IMPORTÉS. **FABRICADO NO CANADÁ COM COMPONENTES CANADIANOS E IMPORTADOS.** FABRICADO EN CANADÁ CON PIEZAS FABRICADAS EN CANADÁ Y PIEZAS IMPORTADAS. ИЗГОТОВЛЕНО В КАНАДЕ С ОТЕЧЕСТВЕННЫМИ И ИМПОРТНЫМИ КОМПОНЕНТАМИ. YERLİ VE İTHAL PARÇALARLA KANADA'DA ÜRETİLMİŞTİR.

صنع في كندا من مواد محلية ومستوردة.

1186 MJ, 1, NL

©2020, MEGA Brands Inc. &™ MEGA Brands Inc. CONSTRUX™ is owned by Mattel and used under license. CONSTRUX™ appartient à Mattel et est utilisée sous licence.
Printed in Canada / Imprimé au Canada

D-GVK83-01



MIX
Paper from responsible sources
Papier issu de sources responsables
FSC® C011825