



**MEGA**  
CONSTRUX

**HotWheels**

**BUILD IT!**  
**CONSTRUIS LE!**  
¡Constrúyelo!  
Você pode construí-lo!  
Mega Bauplast! / Построй!



**WONDER**  
BUILDERS™  
GYG33

**RODGER**  
**DODGER™**





**WONDER  
BUILDERS™**

Fuel their imagination with building toys that support creative thinking and problem solving.

Stimulez leur imagination avec des jouets de construction qui encouragent l'esprit créatif et la résolution de problèmes.

Alimenta su imaginación con juguetes de construcción que ayudan a desarrollar el ensamblado creativo y la resolución de problemas. / Abasteça a imaginação dele com brinquedos de montar que suportam o pensamento criativo e a resolução de problemas. / Dieses Bauspielzeug beflügelt nicht nur die Phantasie, sondern unterstützt auch kreatives und lösungsorientiertes Denken. / Разжигайте воображение детей с помощью конструктора, развивающего творческие способности и логическое мышление.



**Authentic details**  
**Détails authentiques**

Detalles auténticos  
Detalhes autênticos  
Authentische Details  
Реалистичные детали



**Special pieces**  
**Pièces spéciales**

Piezas especiales  
Peças especiais  
Spezielle Teile  
Специальные детали



**Compatible with major brands**  
**Compatible avec**  
**les grandes marques**

Compatible with major brands  
Compatible com a maioria das marcas  
Mit Bausteinen führender Marken kombinierbar  
Совместимость с основными брендами



**Learn more**  
**Pour en savoir plus**

Más información · Sabe mais · Weitere  
Infos gibt es auf · Узнать больше

[play.megaconstrux.com](http://play.megaconstrux.com)

**MEGA™**  
**CONSTRUX**



**Scan here for instructions**  
**Scanner ici pour**  
**obtenir les instructions**

Escanee aquí para  
 obtener instrucciones  
 Digitalize aqui para instruções  
 Hier scannen und Anleitung aufrufen  
 Просканируйте здесь  
 для получения инструкций



[play.megaconstrux.com](http://play.megaconstrux.com)

**1**



**1**



**2**

**3**





# ROGER DODGER™

2

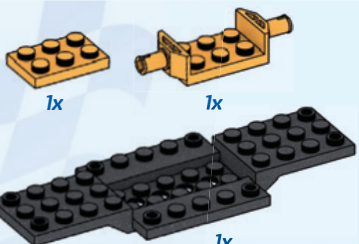

3

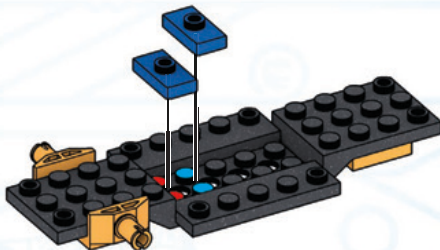
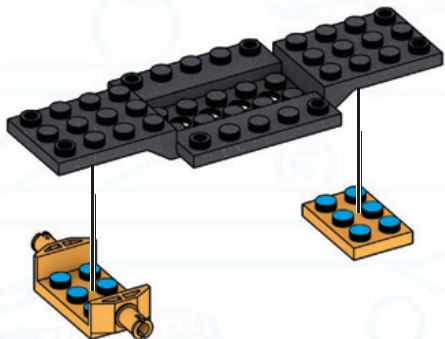

4





4



1x



1x



1x

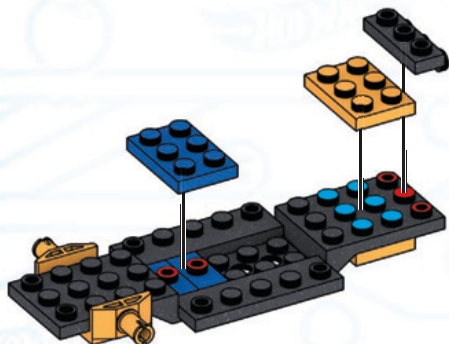

5



2x



2x

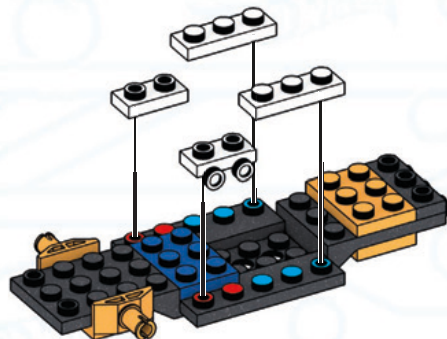

5





# ROGER DODGER™

6



1x

7



1x

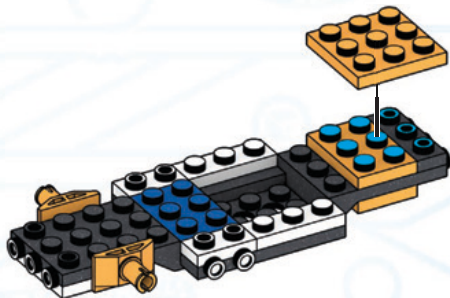
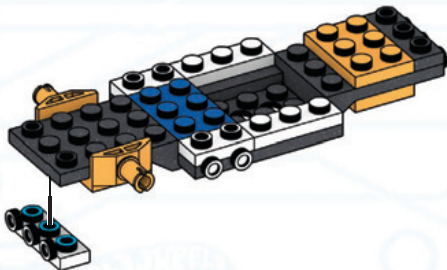

6





8



1x



1x

9



1x

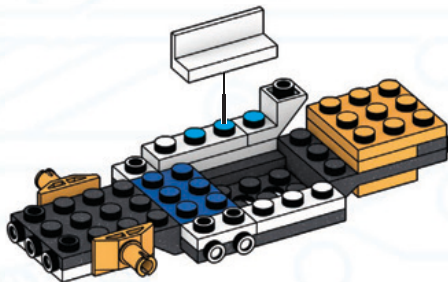
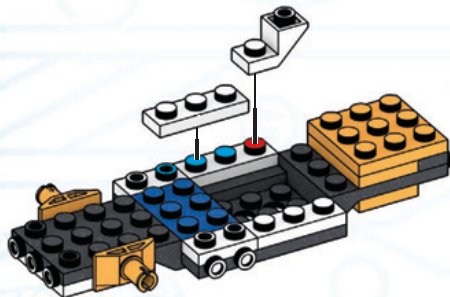



# ROGER DODGER™

10



2x

11



2x

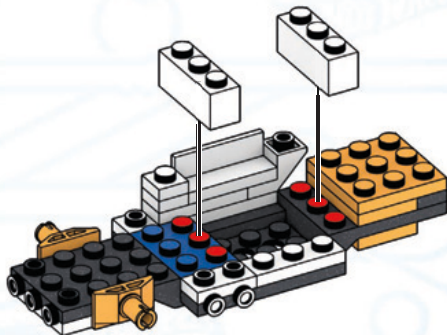
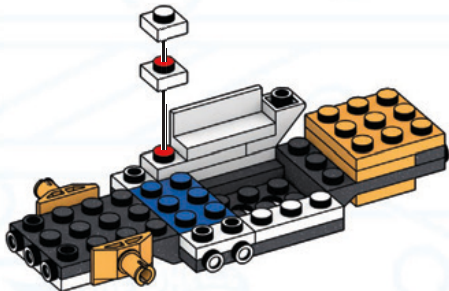





12



1x



1x

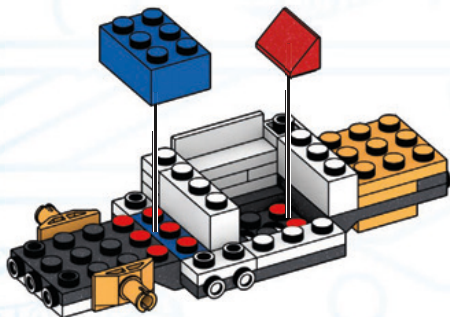

13



1x



1x

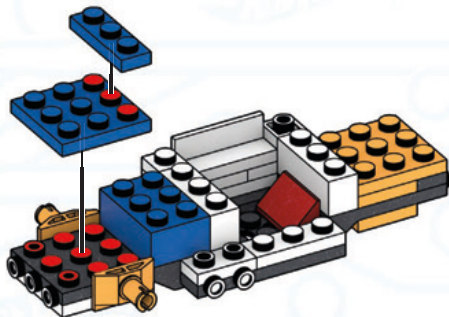



# ROGER DODGER™

14



1x

15



1x



1x

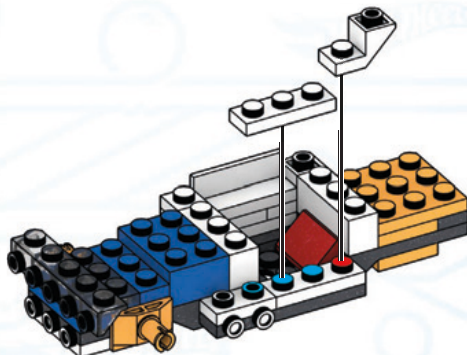
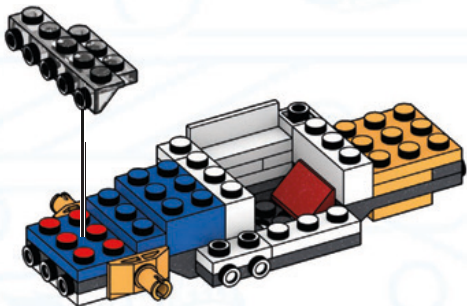

10





16



1x

17



2x

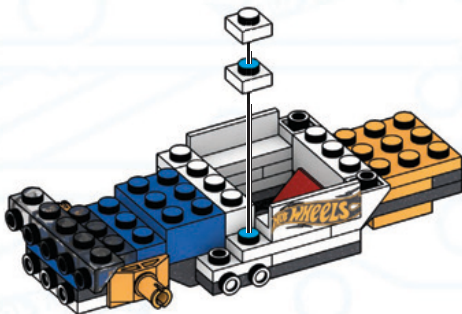
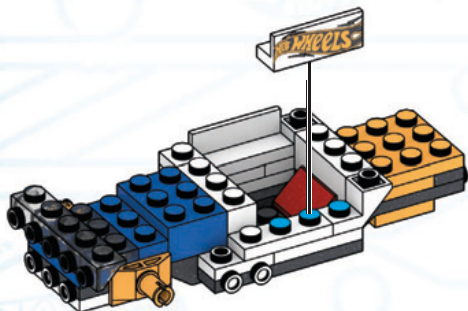



# ROGER DODGER™

18



2x

19



1x



1x

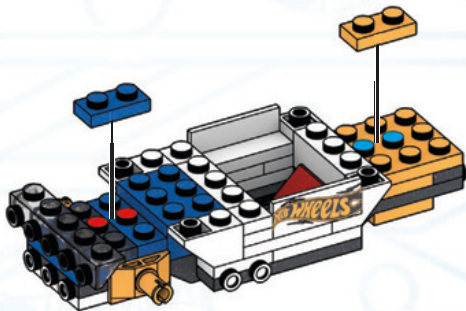
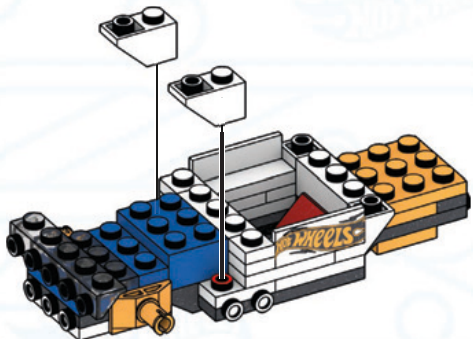

12





20



2x

21



1x



1x

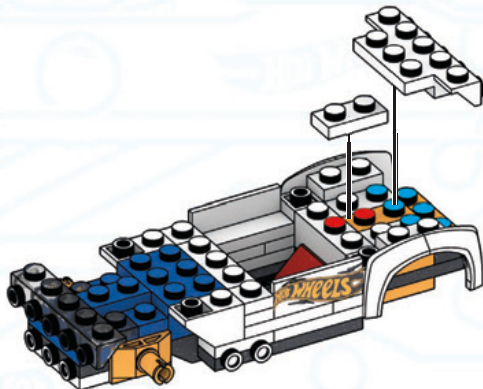
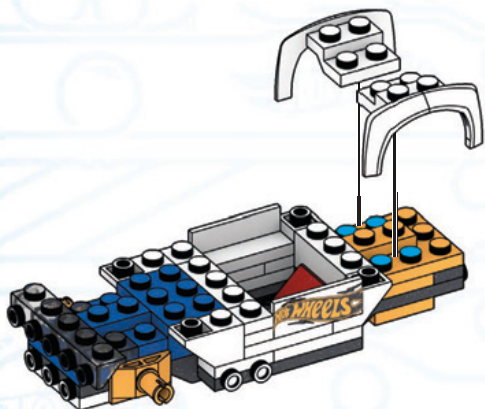



# ROGER DODGER™

## 22



2x



2x

## 23



1x



1x



1



2

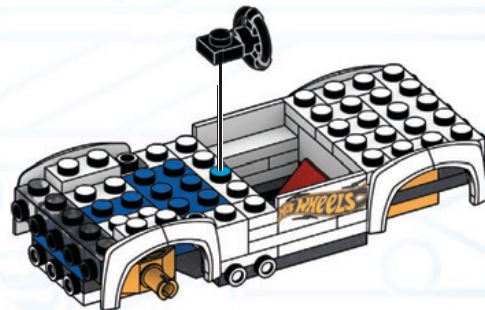
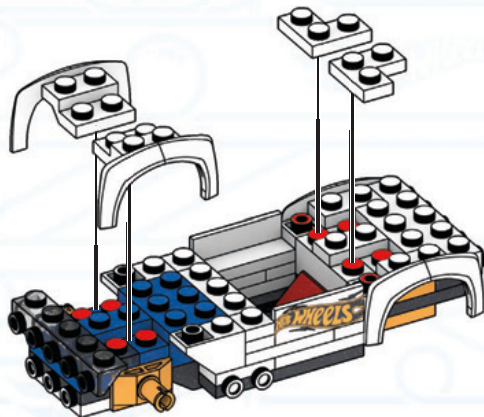



24



2x

25



1x



1x

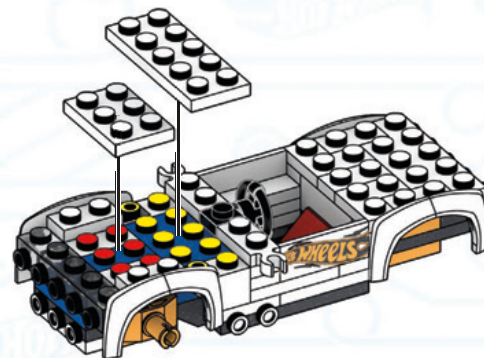
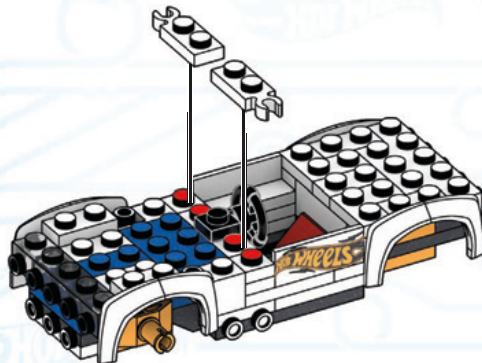

15





# ROGER DODGER™

26



1x

27



1x

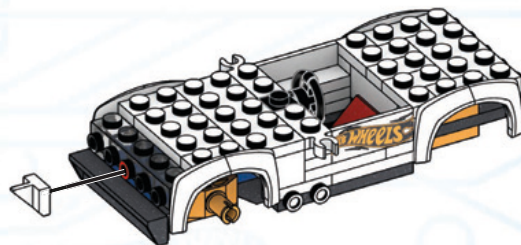
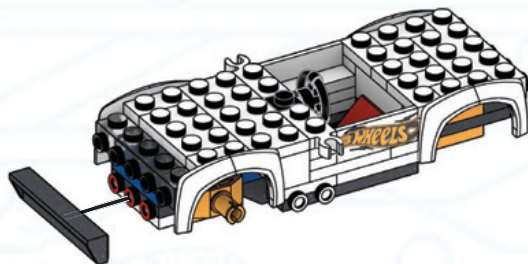

16







**28**



2x

**29**



2x



1x

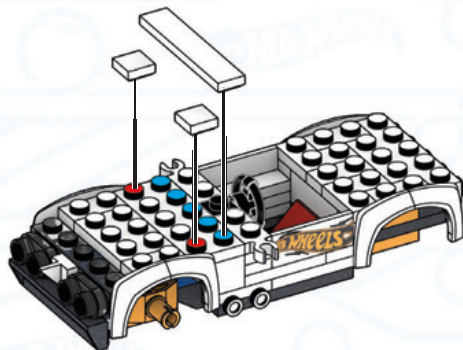
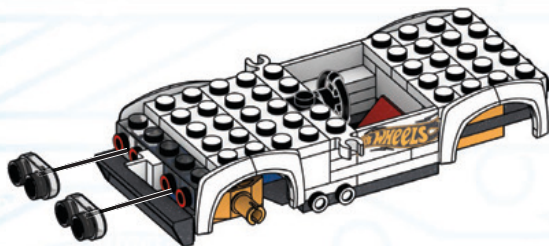



# ROGER DODGER™

30



1x



1x

31



1x



1x



1x

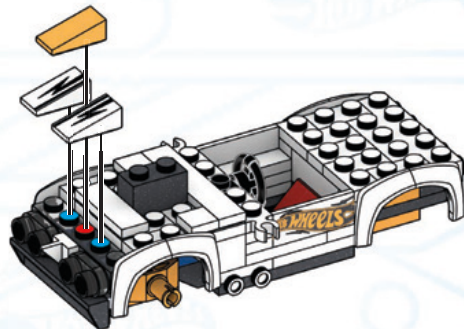
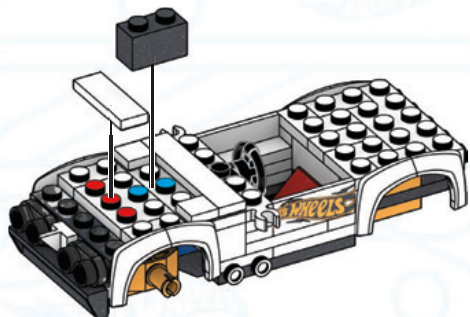



**32**

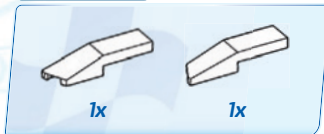

1x

1x

**33**



2x

2x



1

2



1

2

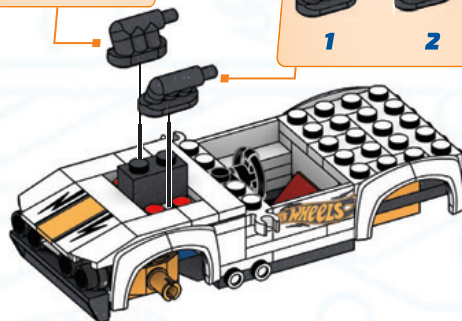
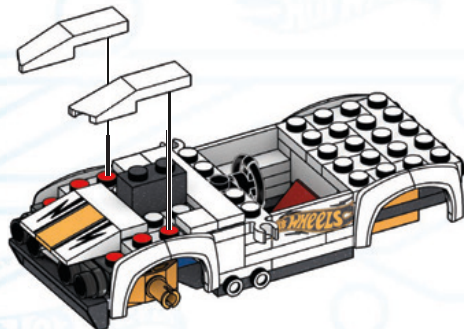



# ROGER DODGER™

34



1x

35



1x

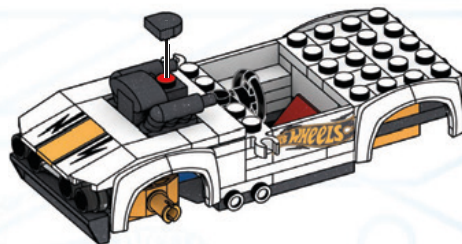
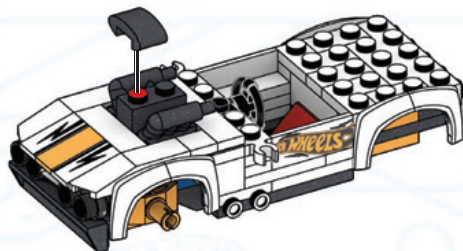



**36**



1x

**37**



1x

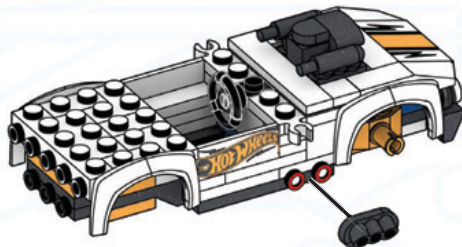
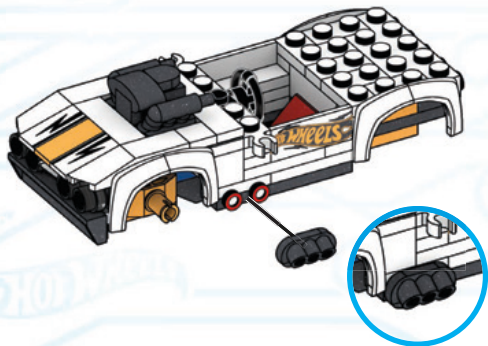



# ROGER DODGER™

**38**



1x

**39**



2x

1x

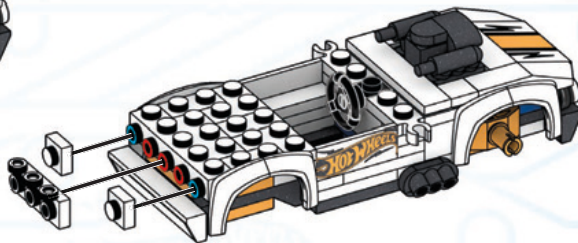
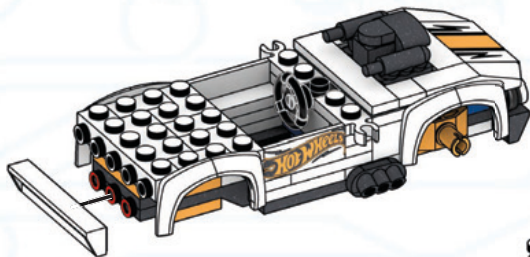



**40**



1x

**41**



1x

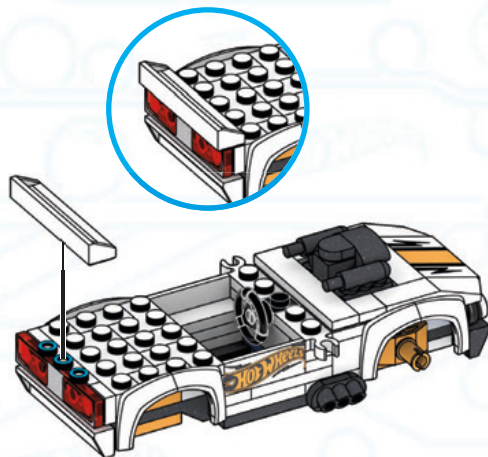
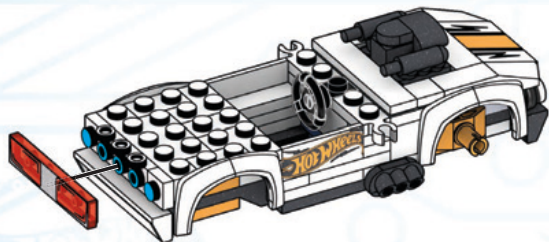



# ROGER DODGER™

42



1x

43



1x



1x

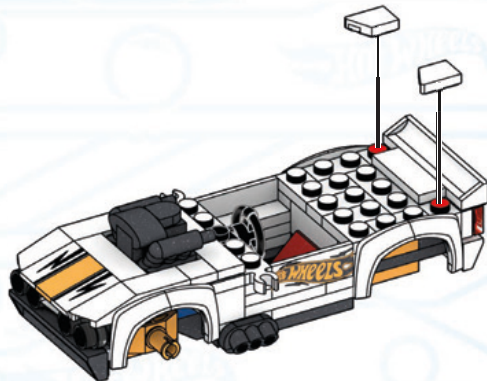
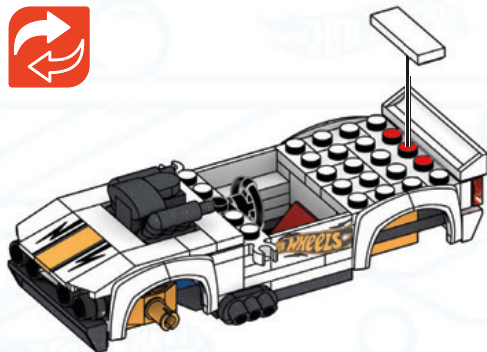





44



1x

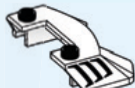

1x

45



1x

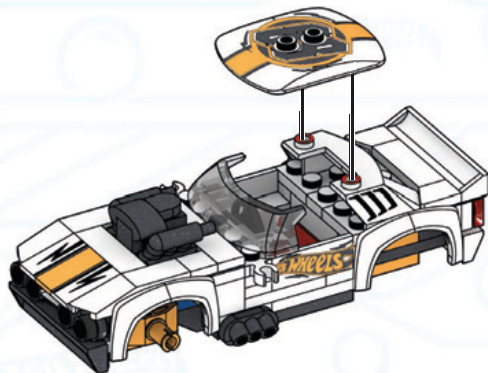
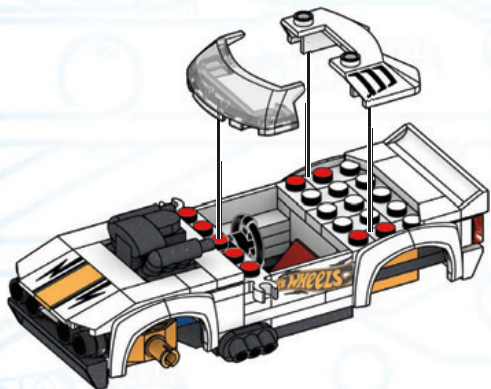



# ROGER DODGER™

46



1x

47



4x

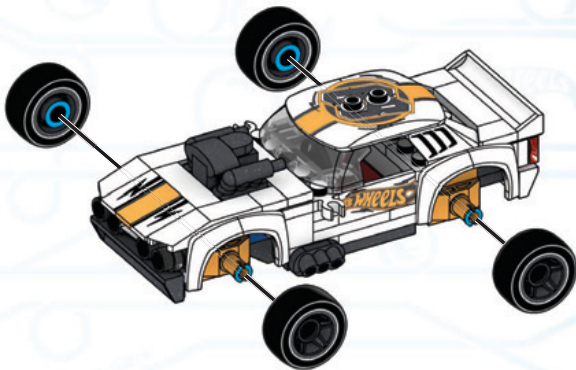
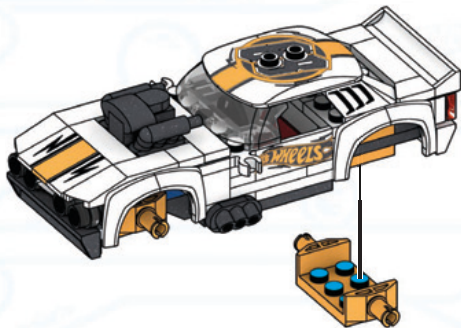



48



1x



1x

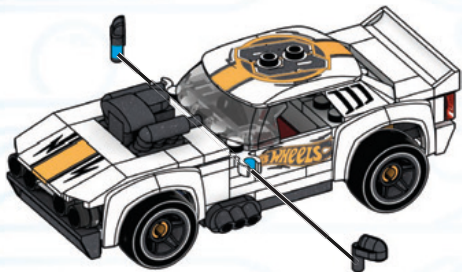

1

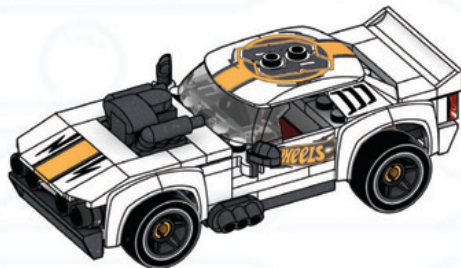

2

27



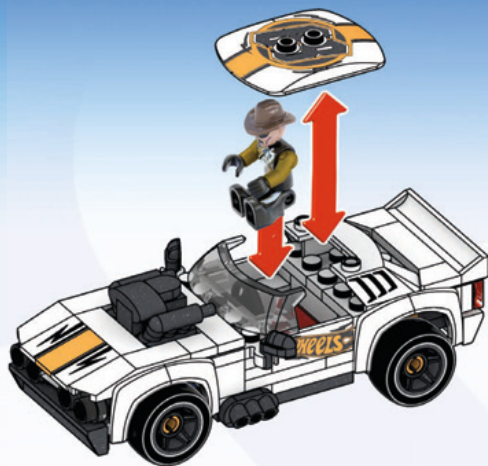

1

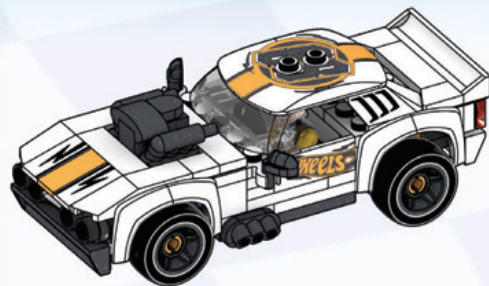

2



## Rebuild your cars into monster trucks \* Réassemble tes voitures pour en faire des Monster Trucks

Convierte tus coches en "Monster Trucks"

Transforma os seus carros em Monster Trucks

Fahrzeuge in Monster Trucks umbauen

Перестраивай свои машинки в монстр-траки



\* Set(s) sold separately and subject to availability. / Ensemble(s) vendu(s) séparément. Certains produits peuvent ne pas être commercialisés. / Se vende(n) por separado y está(n) sujeto(s) a disponibilidad. / Conjunto(s) vendido(s) em separado e sujeito(s) à disponibilidade. / Set in vendita separatamente, secondo disponibilità. / Das/Die Set(s) sind separat erhältlich. / Zestaw(ły) sprzedawany(e) oddzielnie w zależności od dostępności. / Set(s) apart verkrijgbaar en afhankelijk van beschikbaarheid. / Набор(ы) продаются отдельно, при наличии. / Set szelges separat og så længe lager haves. / Seten sąjjs separat så længe lager erkeiser. / Settet/settene selges separat så langt lageret rekker. / Pakkaus/pakkaukset myydään erikseen, saatavuus voi vaihdella. / Το(α) σετ(ς) πωλούνται ξεχωριστά και ανάλογα με τη διαθεσιμότητα. / Setler ayrı olarak satılır ve stokları sınırlıdır. / Set (sety) se prodává (prodávají) samostatně dle aktuální nabídky. / Súprava/-y sa predáva (jú) samostatne a podľa dostupnosti. / A készlet(ek) külön kapható(k), az elérhetőség változhat. /

セツ商品は別売りになります。在庫状況は別途ご確認をお願いします。 / 每套单独发售，按供货情况决定。 / تباع المجموعة أو المجموعات على حدة وتخضع لتوافرها.

Additional purchase required. / Achat additionnel requis. / Zusätzlicher Kauf erforderlich. / Richiede acquisto addizionale. / Aanvullende aankoop vereist. / Requiere compra adicional. / Requer compra adicional. / Ytterligere kjøp kreves. / Edellyttää lisaosien ostamista. / Supplerende køb nødvendigt. / Ekstra kjøp kreves. / Wymagany dodatkowe zakupy. / Vyžaduje dodatečný nákup. / Vyžaduje sa dokúpenie. / További vásárlás szükséges. / Необходима дополнительная покупка. / Αναίτηται επιπλέον αγορά. / Ek ürün satın alınması gerekir.

تتطلب شراء القطع الإضافية.

Most models can be built one at a time. / La plupart des modèles peuvent être construits un à la fois. / La mayoría de modelos se pueden construir de uno en uno. / A maioria dos modelos pode ser construída separadamente. / La maggior parte dei modelli possono essere realizzati uno per volta. / Die meisten Modelle können eines nach dem anderen gebaut werden. / Większość modeli nie da się budować jednocześnie z innymi. / De meeste modellen kunnen één voor één gebouwd worden. / Большинство моделей могут быть собраны по одной за раз. / De fleste modeller kan bygges enkeltvis. / De flesta modeller kan byggas en i taget. / De fleste modellene kan bygges en om gangen. / Seimmat mallit voidaan rakentaa yksi kerrallaan. / Τα περισσότερα μοντέλα μπορούν να κατασκευασθούν ένα ένα. / Modellerein сојуу ayrı ayrı inşa edilmeýi gerektirebilir. / Většinou lze najednou sestavit pouze jeden model. / Väčšina modelov môže byť zostavená iba raz. / A modellek többségéből egyszerre csak egy építhető.

ほとんどのモデルは、一度に一つを組み立てることができます。

يمكن تركيب التصميم الواحد تلو الآخر.

大多數型號可一次性建構。 29

1X  
AM76204MM



2X  
AM07223AFE



6X  
AM03328AFE



1X  
AM76277AFE



1X  
AM74299AFE



1X  
AM74300AFE



1X  
AM80546F



1X  
AM74400MM



1X  
AM74401MM



1X  
AM18220F



2X  
AM81020MM



4X  
AM76469MM



2X  
AM07590B



1X  
AM09393FM



1X  
AM09393AFE



1X  
AM09393B



2X  
AM16649AGY



2X  
AM76467AFE



1X  
AM17128FM



1X  
AS-GYG33-05



1X  
AS-GYG33-04



1X  
AM03019AXW



1X  
AM15555MM



2X  
AM17522AFE



2X  
AM72917AFE



2X  
AM01417AFE



1X  
AM09013MM



2X  
AM15484AFE



2X  
AM80966AFE



4X  
AM01314AFE



1X  
AM01314B



1X  
AM81260MM



2X  
AM81259AFE



1X  
AS-GYG33-02



1X  
AS-GYG33-03



2X  
AM16384AFE



1X  
AM03772B



2X  
AM03772FM



1X  
AM03772AFE



1X  
AM03873B



1X  
AM80981AFE



1X  
AM80982AFE



1X  
AM80973AFE



4X  
AS-GYG33-06



1X  
AM81163B



1X  
AM81163FM



1X  
AM17793AFE



1X  
AS-GYG33-07



2X  
AM81253AFE



1X  
AM81253MM



1X  
AM80969AFE



1X  
AM80970AGY



1X  
AM80965AFE



1X  
AM80538W



1X  
AS-GYG33-01



1X  
AS-GYG33-08



2X  
AM80971FM



1X  
AM80975MM



1X  
FIG-GYG33-A



**Missing pieces?**  
**Pièces manquantes?**  
¿Partes faltantes? • Perdeu peças?  
Fehlen Teile? • Не хватает деталей?

[support.megabrand.com](http://support.megabrand.com)

Mattel Europa B.V., Gondel 1, 1186 MJ Amstelveen, Nederland. Mattel U.K. Limited, The Porter Building, 1 Brunel Way, Slough SL1 1FQ, UK. Mattel France, Parc de la Ceraise, 1/3/5 allée des Fleurs, 94260 Fresnes Cedex. N° Cristal 0969 36 99 99 (Numéro non surtaxé) ou www.lesjouetsmattel.fr Mattel Belgium, Trade Mart, Atomiumsquare, Bogota 202 – B 275, 1020 Brussels. Gratis nummer België: 0800 – 16 936 - Gratis nummer Luxemburg: 800 – 22 784 - Gratis nummer Nederland: 0800 – 262 88 35. Deutschland : Mattel GmbH, Solmsstraße 4, D-60486 Frankfurt am Main. Schweiz: Mattel AG, Kirchstrasse 24, CH-3097 Liebefeld. Österreich: Mattel Ges.m.b.H., Campus 21, Liebermannstraße A01 404, A- 2345 Brunn/Gebirge, Mattel Italy Srl, Via Bracco, 6-MAC 6, 20159 Milano, Italy. Servizio assistenza clienti: Customersrv.italia@mattel.com - Numero verde 800 11 37 11. Mattel España, S.A., Aribau 200, 08036 Barcelona. c.servicio.spain@mattel.com Tel: 902203010 http://www.service.mattel.com/es. Mattel East Asia Ltd., Room 503-09, North Tower, World Finance Centre, Harbour City, Tsimshatsui, HK, China. Tel.: (852) 3185-6500. Diimport & Diederkan Oleh: Mattel Continental Asia Sdn Bhd. Level 19, Tower 3, Avenue 7, No. 8 Jalan Kerinchi, Bangsar South, 59200 Kuala Lumpur, Malaysia. Mattel South Africa (PTY) LTD, Office 102 13, 30 Melrose Boulevard, Johannesburg 2196. Dystributor: Mattel Poland Sp. z o.o., Warsaw Trade Tower 34 p., ul. Chłodna 51, 00-867 Warszawa. Mattel Australia Pty. Ltd., 658 Church St, Richmond, Victoria, 3121. Consumer Advisory Service - 1300 135 312. Mattel AEBE, Εθάρπου Μακρικού 1, Κτήριο Κ-2, ΤΚ 17561, Παλάσι Φάληρο. Mattel Oyuncakçılık Tic. Ltd. Şti. İçerenköy Mah., Erkuş Sok. A Blok No:12 Üner Plaza Kat:9-10 34752 Ataşehir İstanbul. Tel: 0216 570 75 00. Импортёр/Уполномоченная организация: ООО "МАТЕЛ" Российская Федерация, 105120 Москва, 2-й Сыромятинский переулок, 1; +7 495 287 79 39. Forg.: Mattel Toys Hungary Kft 1139 Budapest Váci út 91. +36 1 270 0223. Mattel Czech Republic s.r.o., The Forum, Václavské nám. 19-110 Praha 1. Mattel, 333 Continental Boulevard, El Segundo, CA 90245, USA. Consumer Services: 1-800-465-MEGA (6342). Importado y distribuido por Mattel de México, S.A. de C.V., Miguel de Cervantes Saavedra No. 193, Pisos 10 y 11, Col. Granada, Alcaldía Miguel Hidalgo, C.P. 11520, México, Ciudad de México. R.F.C. MME-920701-NB3. Tels.: 59-05-51-00 Ext. 5206 ó 01-800-463-59-89. Mattel Chile, S.A., Avenida América Vespucio 501-B, Quilicura, Santiago. Tel.: 1230-020-6213. Servicio al consumidor Venezuela: Tel.: 0-800-100-9123. Mattel Argentina, S.A., Av. Libertador 1000, Piso 11 – Oficinas 109 y 111, Vicente López – Prov. Buenos Aires. Tel.: 0800-666-3373. Mattel Colombia, S.A., Calle 123#7-07 P5, Bogotá. Tel.: 01800-710-2069. Mattel Perú, S.A., Av. Juan de Arona # 151, Centro Empresarial Juan de Arona, Torre C, Piso 7, Oficina 704, San Isidro, Lima 27, Perú. RUC: 20425853865. Reg. Importador: 02350-12-JUE-DIGESA. Tel.: 0800-54744. E-mail Latinoamérica: servicio.clientes@mattel.com. Mattel do Brasil Ltda. - CNPJ : 54.558.002/0001-20 - Rua Verbo Divino, 1488 - 2º. Andar - 04719-904 - Chácara Santo Antônio - São Paulo - SP - Brasil. Serviço de Atendimento ao Consumidor: fone 0800 575 0780. E-mail: sa.matteldobrazil@mattel.com

⚠️ WARNING:  
CHOKING HAZARD. - Small parts.  
Not for children under 3 years.

⚠️ ATTENTION:  
DANGER D'ÉTOUFFEMENT. - Présence de petits éléments.  
Ne convient pas aux enfants de moins de 3 ans.

⚠️ 警告:  
のどにつまる危険 小さな部品が含まれています  
3歳以下の子供には与えないで下さい。

تحذير:  
غير مناسبة للأطفال دون 36 شهراً - قطع صغيرة.

⚠️ 警告!  
不适合3岁以下儿童使用。  
内含小零件。

ADVERTENCIA: PELIGRO DE ATRAGANTAMIENTO. Juguete no recomendado para menores de 3 años, porque contiene piezas pequeñas que podrían provocar asfixia en caso de ser ingeridas o inhaladas por el/la niño/a.

ATENÇÃO! Não indicado / não recomendável para crianças menores de 3 (três) anos por conter parte(s) pequena(s) que pode(m) ser engolidas(o) ou aspirada(s) podendo provocar asfixia.

AVVERTENZA: Contiene pezzi di piccole dimensioni.

ACHTUNG: Kleine Teile.

OSTRZEŻENIE: Małe części. Niebezpieczeństwo zadławienia.

WAARSCHUWING: Kleine onderdelen

ΠΡΕΔΥΠΡΕΞΗΝΗ: Μελκίε δεταλί.

ADVARSEL: Indeholder små dele.

VARNING: Smådelar

ADVARSEL: Små deler

VAROITUS: Pieniä osia

ΠΡΟΣΟΧΗ: Περιλαμβάνονται μικρά κομμάτια.

UYARI: Küçük parçalar.

UPOZORNĚNÍ: Malé díly

UPOZORNENIE: Malé časti

FIGYELMEZTÉZÉS: Kis alkatrészek.



Ⓟ D714,887, D781,964, D797,203



MEGA  
CONSTRUX

# HOT WHEELS

## RODGER DODGER™



play.megaconstrux.com

10+  
PRO  
BUILDERS™

### Are you ready for the next challenge? Prêt pour le prochain défi?

¿Estás listo para el siguiente desafío?  
Você está pronto para o próximo desafio?  
Bist du bereit für die nächste Herausforderung?  
Вы готовы к следующему испытанию?

### MORE TO BUILD! ENCORE PLUS À CONSTRUIRE!

¡MÁS PARA CONSTRUIR! • MAIS PARA CONSTRUIR!

MEHR ZUM BAUEN! • КОНСТРУИРУЙ БОЛЬШЕ!



GVM27



GVM31



GVG32



GVM29



GVM26



Set(s) sold separately and subject to availability. / Ensemble(s) vendu(s) séparément. Certains produits peuvent ne pas être commercialisés. / Se vende(n) por separado y está(n) sujeto(s) a disponibilidad. / Conjunto(s) vendido(s) em separado e sujeito(s) à disponibilidade. / Set in vendita separatamente, secondo disponibilità. / Das/Die Set(s) sind separat erhältlich. / Zestaw(y) sprzedawany(e) oddzielnie w zależności od dostępności. / Set(s) apart verkrijgbaar en afhankelijk van beschikbaarheid. / Набор(-ы) продаются отдельно, при наличии. / Sæt sælges separat og så længe lager haves. / Seten säljs separat så länge lagret räcker. / Sættet/settene selges separat så langt lageret rekker. / Pakkaus/pakkausset myydään erikseen, saatavuus voi vaihdella. / Το(α) σετ πωλούνται ξεχωριστά και ανάλογα με τη διαθεσιμότητα. / Setler ayrı olarak satılır ve stoklarına sinirlidir. / Set (sety) se prodává (prodávají) samostatně dle aktuální nabídky. / Súprava/-y sa predáva(jú) samostatne a podľa dostupnosti. / A készlet(ek) külön kapható(k), az elérhetőség változhat. / セット商品は別売りになります。在庫状況は別途ご確認をお願いします。 / تباع المجموعات أو تخضع لتوافرها.

## 每套单独发售，按供货情况决定。

1186 MJ, 1, NL

© 2020, MEGA Brands &™ MEGA Brands; CONSTRUX™, HOT WHEELS and associated trademarks and trade dress are owned by and used under license from Mattel. CONSTRUX™, HOT WHEELS ainsi que les marques et designs y afférents appartiennent à, et sont utilisés sous licence de Mattel. © 2020 Mattel. Printed in China / Imprimé en Chine AD-GYG33-01

