

MEGA™

HotWheels

BUILDING SETS



**WONDER
BUILDERS™**

GYG34

**BAJA TRUCK
CAMION BAJA**





Fuel their imagination with building toys that support creative thinking and problem solving.

Stimulez leur imagination avec des jouets de construction qui encouragent l'esprit créatif et la résolution de problèmes.

Alimenta su imaginación con juguetes de construcción que ayudan a desarrollar el ensamblaje creativo y la resolución de problemas. / Abasteça a imaginação dele com brinquedos de montar que suportam o pensamento criativo e a resolução de problemas. / Dieses Bauspielzeug beflügelt nicht nur die Phantasie, sondern unterstützt auch kreatives und lösungsorientiertes Denken. / Разжигайте воображение детей с помощью конструктора, развивающего творческие способности и логическое мышление.



Authentic details Détails authentiques

Detalles auténticos
Detalhes autênticos
Authentische Details
Реалистичные детали



Special pieces Pièces spéciales

Piezas especiales
Peças especiais
Spezielle Teile
Специальные детали

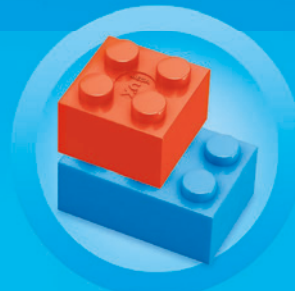

Compatible with major brands Compatible avec les grandes marques

Compatible with major brands
Compatible com a maioria das marcas
Mit Bausteinen führender Marken kombinierbar
Совместимость с основными брендами

Learn more Pour en savoir plus

Más información · Sabe mais · Weitere
Infos gibt es auf · Узнать больше

play.megaconstrux.com

MEGATM
CONSTRUX

MEGA
UNBOXED



Build Assemblez

Construye | Constrói
Bauen | Стройте



Share | Partagez

Comparte | Partilha
Teilen | Делитесь

Devices not included | Appareils non inclus | Dispositivos não incluído | Dispositivos não incluídos | Geräte nicht enthalten
Устройства не входят в комплект



Build ideas & challenges! Des idées de construction et des défis!

¡Crea ideas y desafíos!
Desafios e ideias para construções!
Verschiedene Bauideen und
Herausforderungen!
Открывайте новые
идеи и испытания!



Set(s) sold separately and subject to availability. / Ensemble(s) vendu(s) séparément. Certains produits peuvent ne pas être commercialisés. / Se vende(n) por separado e está(n) sujeito(s) a disponibilidade. / Conjunto(s) vendido(s) em separado e sujeito(s) à disponibilidade. / Set in vendita separatamente, secondo disponibilità. / Das/Die Set(s) sind separat erhältlich. Набор(-ы) продаются отдельно, при наличии.

unboxed.megaconstrux.com



1



1



2

3



BAJA TRUCK · CAMION BAJA

2



2x



2x

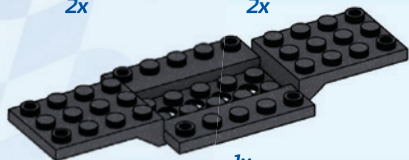

1x

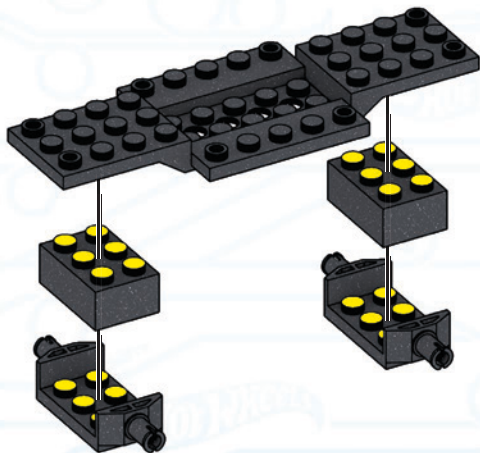

3

1x



1x

4

2x



2x

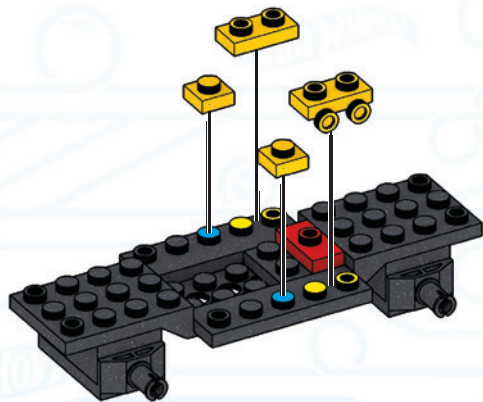
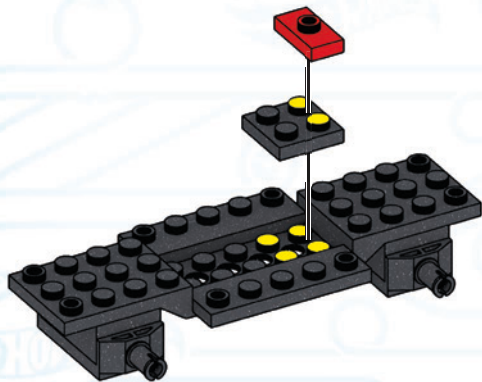



BAJA TRUCK - CAMION BAJA

5



2x

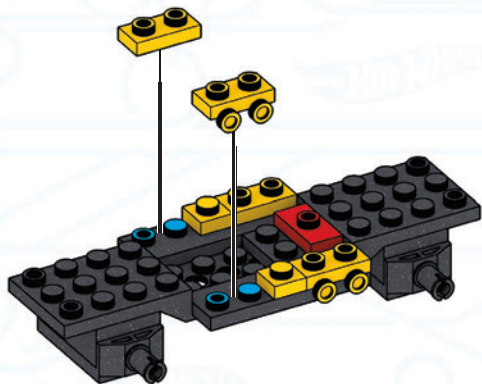

6



1x



1x

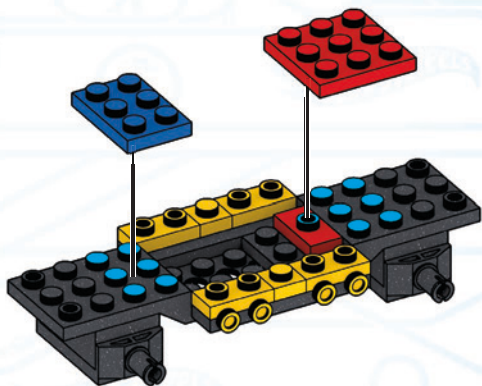

7



1x

8



1x

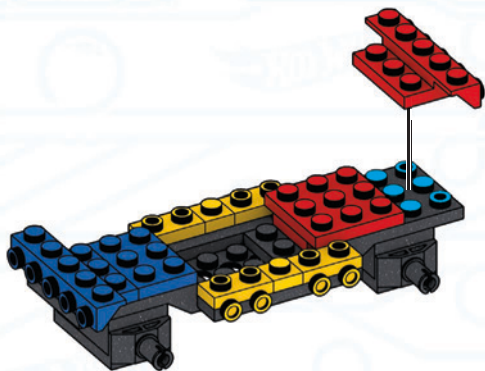
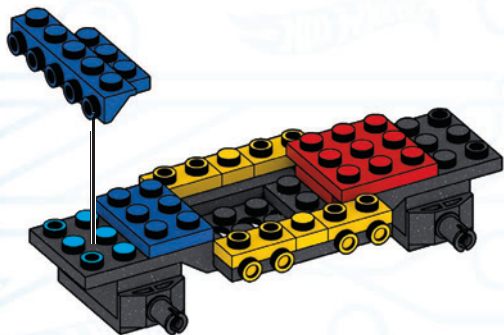



BAJA TRUCK - CAMION BAJA

9



1x

10



2x

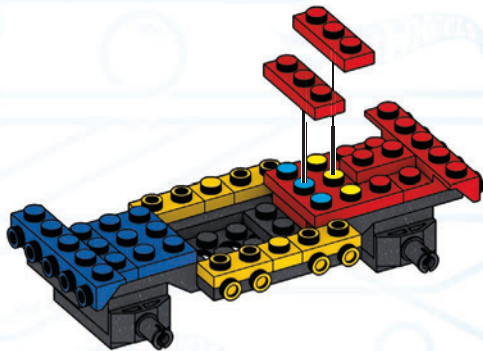
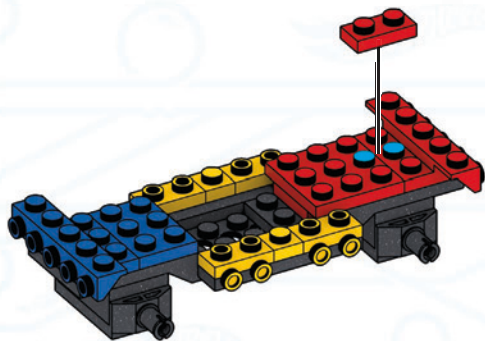

11

1x



1x



1x

12

2x

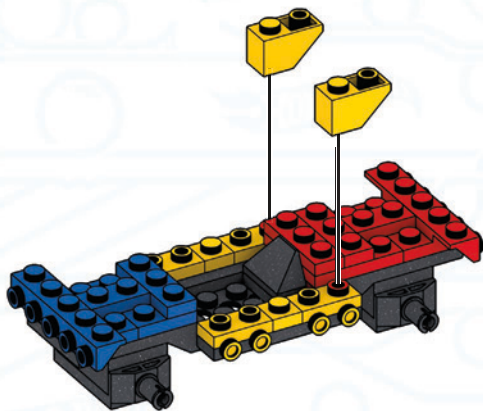
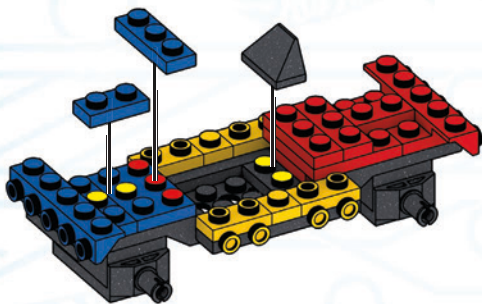



BAJA TRUCK · CAMION BAJA

13



2x

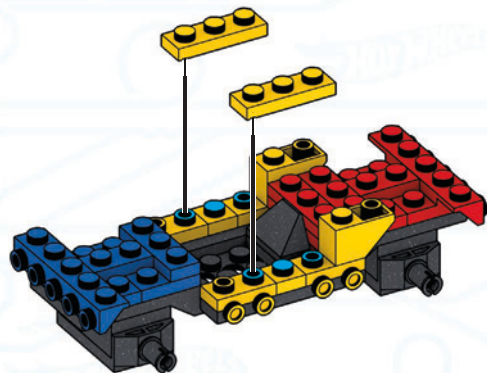

14



1x



1x

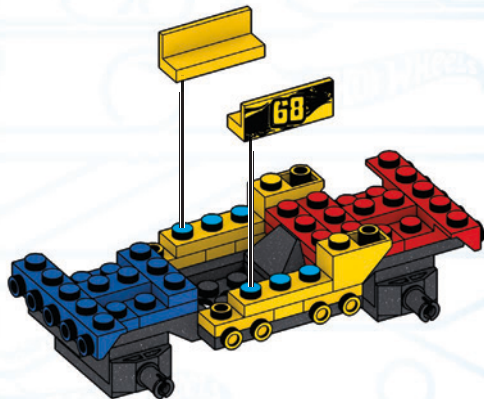

15



2x

16



4x

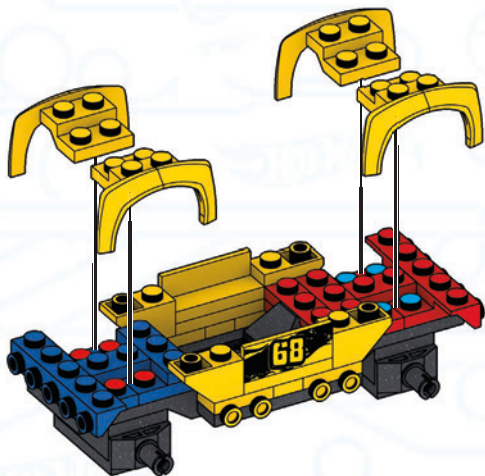
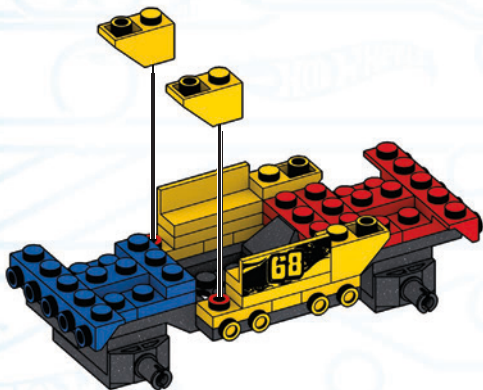



BAJA TRUCK · CAMION BAJA

17



1x



1x

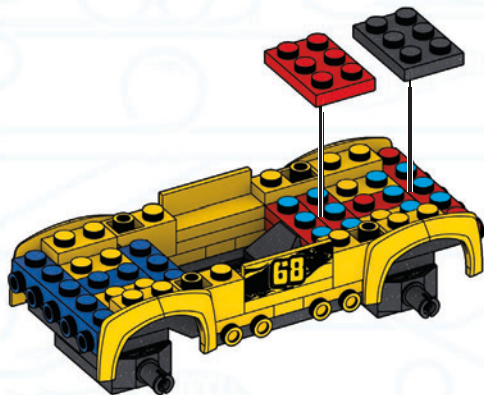

18



1x



1x

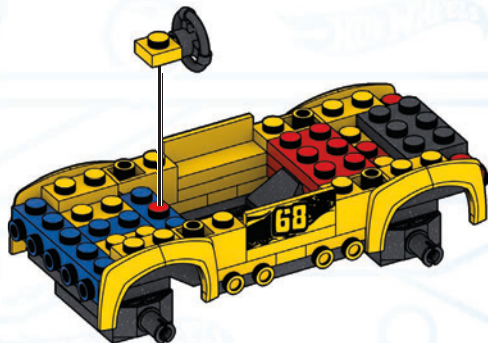
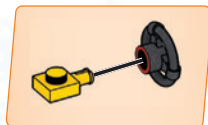

19



2x



1x

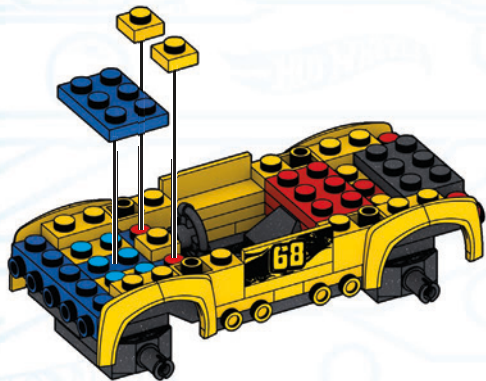

1

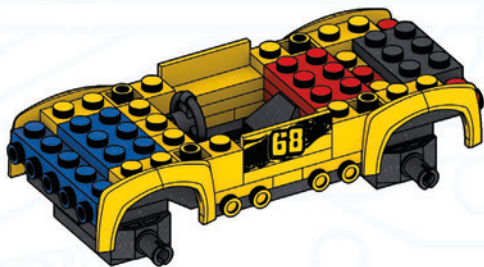

2



BAJA TRUCK - CAMION BAJA

20



1x



1x

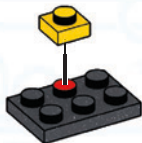

21



2x



1x



1x

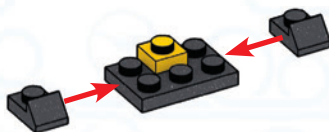

1

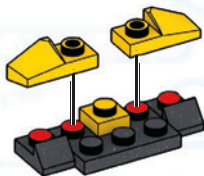

2

22



3x

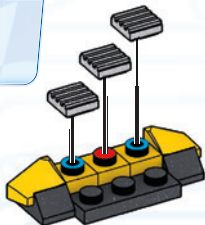

23



3x

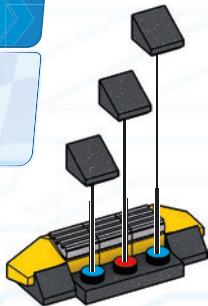

1

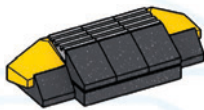

2

24

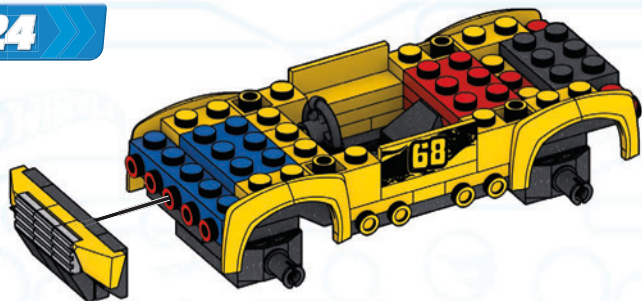

25



1x



1x

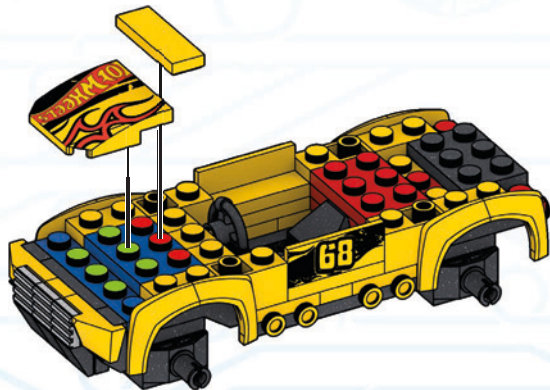



BAJA TRUCK · CAMION BAJA

26



2x



1x

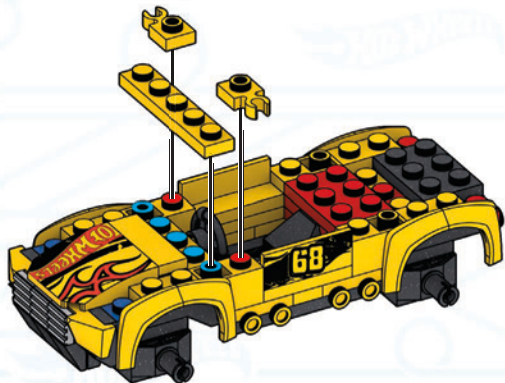

27



2x

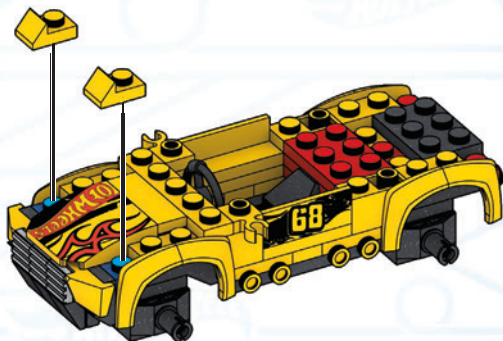

28

2x



1x



1x

29

1x



1x

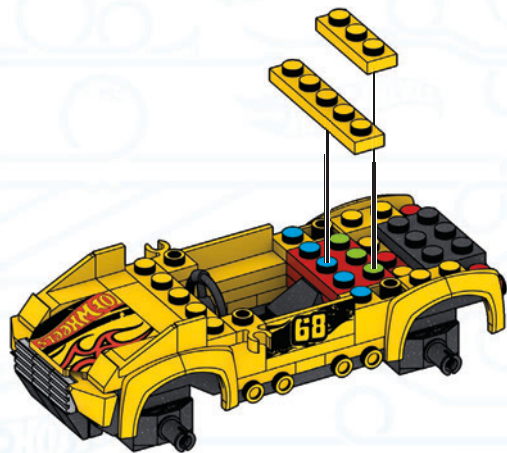
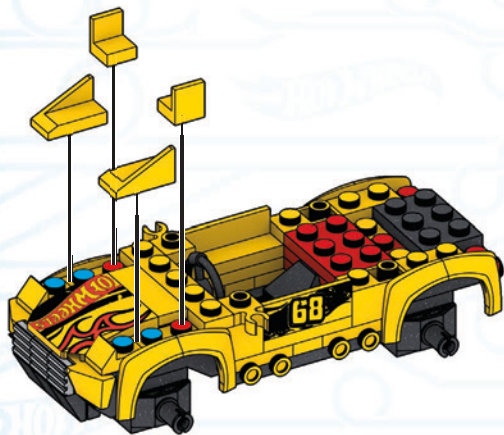



BAJA TRUCK · CAMION BAJA

30



2x

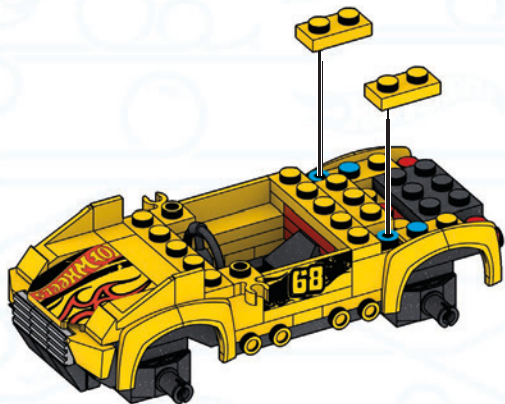

31



1x

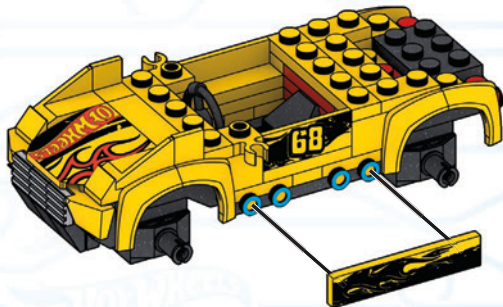

32



1x

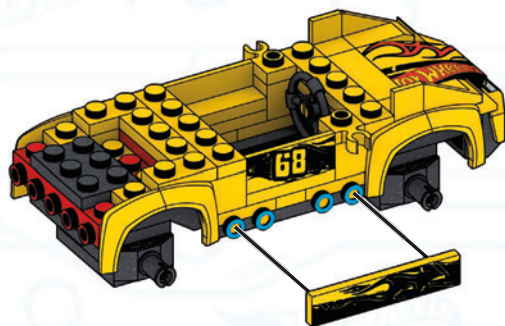



BAJA TRUCK · CAMION BAJA

33



1x



1x

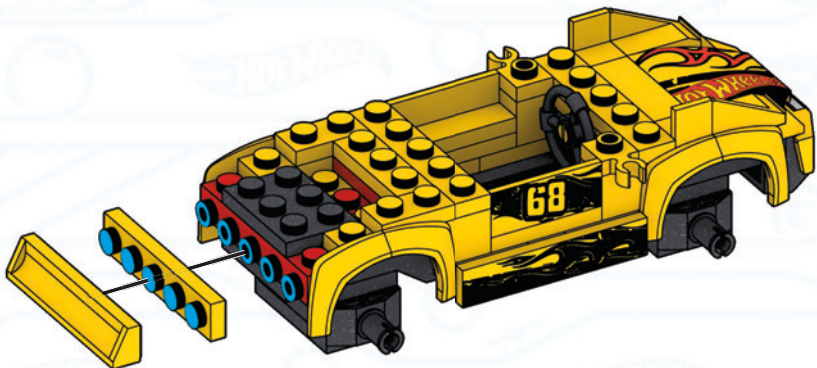

34



3x

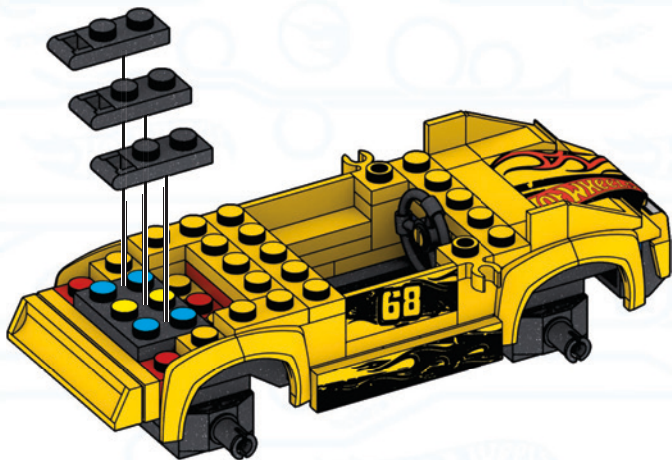



BAJA TRUCK · CAMION BAJA

35



2x



2x

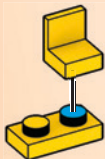

1



2

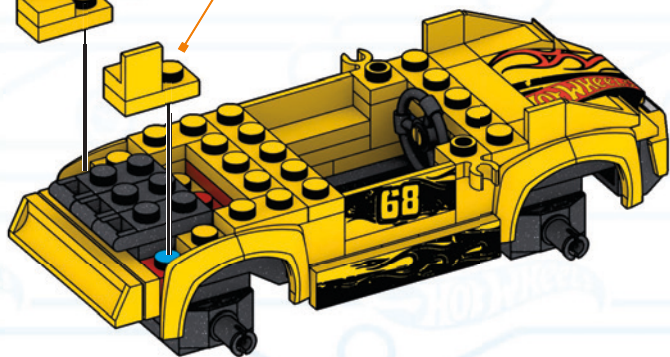

36



1x



1x

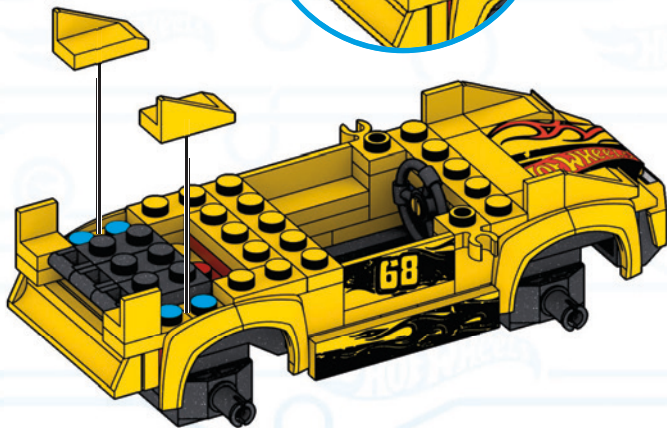



BAJA TRUCK · CAMION BAJA

37



3x

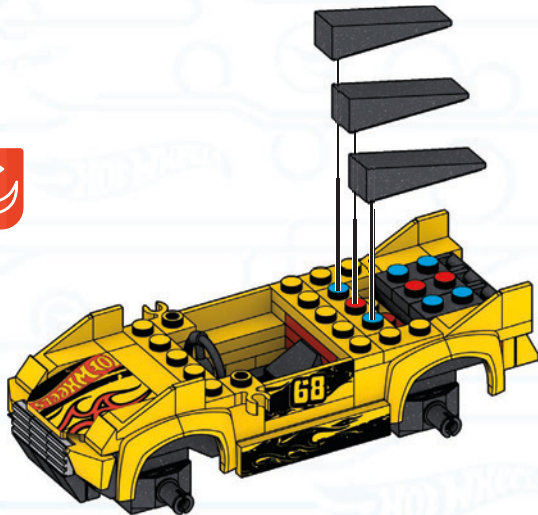

38



1x



1x

39



1x

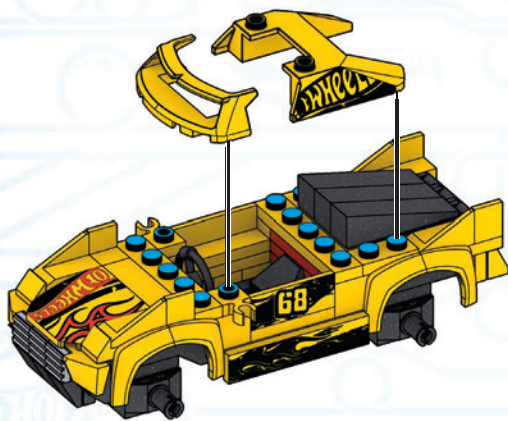



BAJA TRUCK · CAMION BAJA

40



4x

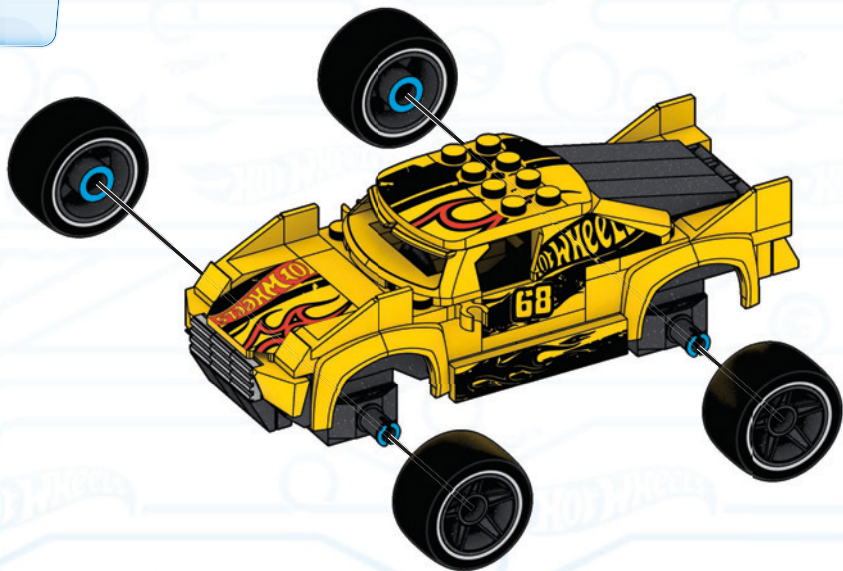

41



1x

1x

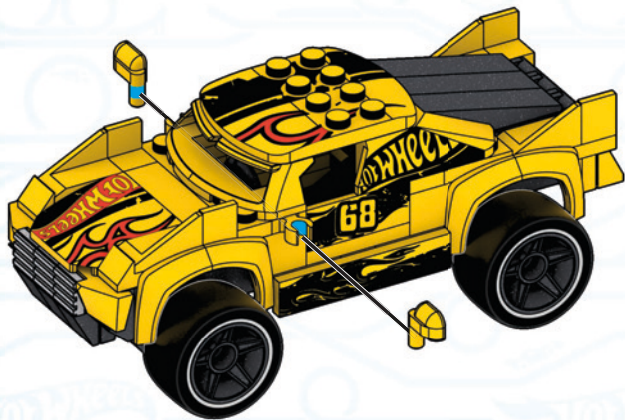

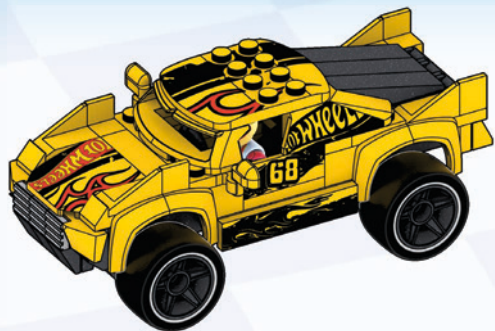

Rebuild your cars into monster trucks • Réassemble tes voitures pour en faire des Monster Trucks

Convierte tus coches en "Monster Trucks"

Transforma os seus carros em Monster Trucks

Fahrzeuge in Monster Trucks umbauen

Перестраивай свои машинки в монстр-траки



* Set(s) sold separately and subject to availability. / Ensemble(s) vendu(s) séparément. Certains produits peuvent ne pas être commercialisés. / Se vende(n) por separado y está(n) sujeto(s) a disponibilidad. / Conjunto(s) vendido(s) em separado e sujeito(s) à disponibilidade. / Set in vendita separatamente, secondo disponibilità. / Das/Die Set(s) sind separat erhältlich. / Zestaw(y) sprzedawany(e) oddzielnie w zależności od dostępności. / Set(s) apart verkrijgbaar en afhankelijk van beschikbaarheid. / Набор(-ы) продаются отдельно, при наличии. / Sæt sælges separat og så længe lager haves. / Seten säljs separat så länge lagret räcker. / Sættet/settene selges separat så langt lageret rekker. / Pakkaus/pakkaukset myydään erikseen, saatavuus voi vaihdella. / Το(α) σετ(α) πωλούνται ξεχωριστά και ανάλογα με τη διαθεσιμότητα. / Setler ayrı olarak satılır ve stoklarla sınırlıdır. / Set (sety) se prodává (prodávají) samostatně dle aktuální nabídky. / Súprava/-y sa predáva(jú) samostatne a podľa dostupnosti. / A készlet(ek) külön kapható(k), az elérhetőség változhat. /

セト商品は別売りになります。在庫状況は別途ご確認をお願いします。 / 每套单独发售，按供货情况决定。 /

Additional purchase required. / Achat additionnel requis. / Zusätzlicher Kauf erforderlich. / Richiede acquisto addizionale. / Aanvullende aankoop vereist. / Requiere compra adicional. / Requier compra adicional. / Ytterligere kjøp kreves. / Edellyttää lisäosien ostamista. / Supplerende køb nødvendig. / Ekstra kjøp kreves. / Wymagany dodatkowe zakupy. / Vyžaduje dodatečný nákup. / Vyžaduje sa dokúpenie. / További vásárlás szükséges. / Необходима дополнительная покупка. / Αναπτεται επιπλέον αγορά. / Ek ürünü satın alınması gerekir.

تطلب شراء القطع الإضافية

Most models can be built one at a time. / La plupart des modèles peuvent être construits un à la fois. / La mayoría de modelos se pueden construir de uno en uno. / A maioria dos modelos pode ser construída separadamente. / La maggior parte dei modelli possono essere realizzati uno per volta. / Die meisten Modelle können eines nach dem anderen gebaut werden. / Większości modeli nie da się budować jednocześnie z innymi. / De meeste modellen kunnen één voor één gebouwd worden. / Большинство моделей могут быть собраны по одной за раз. / De fleste modeller kan bygges enkeltvis. / De flesta modeller kan byggas en i taget. / De fleste modellene kan bygges en om gangen. / seimmat mallit voidaan rakentaa yksi kerrallaan. / Τα περισσότερα μοντέλα μπορούν να κατασκευασθούν ένα ένα. / Modellerein çoğu ayrı ayrı edilmeği gerektirebilir. / Většinou lze najednou sestavit pouze jeden model. / Väčšina modelov môže byť zostavená iba raz. / A modellek többségéből egyszerre csak egy építhető.

ほとんどのモデルは、一度に一つを組み立てることができます。

يمكن تركيب التصميم الواحد تلو الآخر.

大多數型號可一次性建構。 29

1x
AM74401BYE

1x
AM74400BYE

5x
AM03328BYE

3x
AM79666APG

3x
AM17127MM

4x
AM15485BYE

1x
AM80546BYE

2x
AM18591BYE

2x
AM19530BYE

2x
AM19530MM

1x
AM07590AMC

4x
AM09393BYE

1x
AM09393AMC

1x
AM09393B

1x
AM18220MM

4x
AM76467BYE

1x
AM72496BYE

1x
AM72497BYE

2x
AM81255BYE

2x
AM81256BYE

4x
AM01417BYE

1x
AM19061MM

1x
AM03773MM

3x
AM16954MM

1x
AM80966BYE

3x
AM01314BYE

1x
AM01314B

2x
AM01314AMC

1x
AS-GYG34-06

1x
AS-GYG34-07

2x
AM03772MM

2x
AM03772B

1x
AM03772AMC

2x
AM03873MM

4x
AM80973BYE

1x
AM81163AMC

1x
AS-GYG34-08

4x
AS-GYG34-01

1x
AM80970B

1x
AM80970AMC

3x
AM16959MM

3x
AM07475BYE

1x
AM81253BYE

1x
AS-GYG34-04

1x
AS-GYG34-02

1x
AS-GYG34-03

1x
AM80975MM

1x
AS-GYG34-05

2x
AM80971MM

1x
AM81251BYE



Missing pieces?
Pièces manquantes?
¿Partes faltantes? • Perdeu peças?
Fehlen Teile? • Не хватает деталей?

support.megabrand.com

Mattel Europa B.V., Gondel 1, 1186 MJ Amstelveen, Nederland. Mattel U.K. Limited, The Porter Building, 1 Brunel Way, Slough SL1 1FQ, UK. Mattel France, Parc de la Cerisaie, 1/3/5 allée des Fleurs, 94260 Fresnes Cedex. N° Cristal 0969 36 99 99 (Numéro non surtaxé) ou www.lesjouetsmattel.fr Mattel Belgium, Trade Mart, Atomiumsquare, Bogota 202 – B 275, 1020 Brussels. Gratis nummer België: 0800 – 16 936 – Gratis nummer Nederland: 800 – 22 784 – Gratis nummer Nederland: 0800 – 262 88 35. Deutschland: Mattel GmbH, Solmsstraße 4, D-60486 Frankfurt am Main. Schweiz: Mattel AG, Kirchstrasse 24, CH-3097 Liebefeld. Österreich: Mattel Ges.m.b.H., Campus 21, Liebermannstraße A01 404, A- 2345 Brunn/Gebrige. Mattel Italy Srl, Via Bracco, 6-MAC 6, 20159 Milano, Italy. Servizio assistenza clienti: Customersrv.italia@mattel.com - Numero verde 800 11 37 11. Mattel España, S.A., Arbuza 200. 08036 Barcelona. c.servicio.spain@mattel.com. Tel: 902203010 http://www.service.mattel.com/es. Mattel East Asia Ltd., Room 503-09, North Tower, World Finance Centre, Harbour City, Tsimshatsui, HK, China. Tel.: (852) 3185-6500. Diimport & Diedarkan Oleh: Mattel Continental Asia Sdn Bhd. Level 19, Tower 3, Avenue 7, No. 8 Jalan Kerinchi, Bangsar South, 59200 Kuala Lumpur, Malaysia. Mattel South Africa (PTY) LTD, Office 102 13, 30 Melrose Boulevard, Johannesburg 2196. Dystrybutor: Mattel Poland Sp. z o.o., Warsaw Trade Tower 34 p., ul. Chłodna 51, 00-867 Warszawa. Mattel Australia Pty Ltd., 658 Church St., Richmond, Victoria, 3121. Consumer Advisory Service - 1300 135 312. Mattel AEBE, Εθνόγρου Μακρορίου 1, Κτήριο Κ-2, ΤΚ 17561, Πολιάλι Φάληρο. Mattel Oυνιακλήη TIC. Ltd. Σti. Iereñkoy Mah., Erkut Sok. A Blok No:12 Üner Plaza Kat:9-10 34752 Ataşehir Istanbul. Tel: 0216 570 75 00. Импортёр/Уполномоченная организация: ООО "МАТЕЛ" Российская Федерация, 105120 Москва, 2-й Сыромиятинский переулок, 1; +7 495 287 79 39. Forg.: Mattel Toys Hungary Kft 1139 Budapest Váci út 91. +36 1 270 0223. Mattel Czech Republic s.r.o., The Forum, Václavské nám. 19, 11000 Praha 1. Mattel, 333 Continental Boulevard, El Segundo, CA 90245, USA. Consumer Services: 1-800-465-MEGA (6342). Importado y distribuido por Mattel de México, S.A. de C.V., Miguel de Cervantes Saavedra No. 193, Pisos 10 y 11, Col. Granada, Alcaldía Miguel Hidalgo, C.P. 11520, México, Ciudad de México. R.F.C. MME-920701-NB3. Tels.: 59-056 51-00 Ext. 5206 ó 01-800-463-59-89. Mattel Chile, S.A., Avenida América Vespuccio 501-B, Quilicura, Santiago. Tel.: 1230-020-6213. Servicio al consumidor Venezuela: Tel.: 0-800-100-9123. Mattel Argentina, S.A., Av. Libertador 1000, Piso 11 – Oficinas 109 y 111, Vicente López – Prov. Buenos Aires. Tel.: 0800-666-3373. Mattel Colombia, S.A., Calle 12347-07 P5, Bogotá. Tel.: 01800-710-2069. Mattel Perú, S.A., Av. Juan de Arona # 151, Centro Empresarial Juan de Arona, Torre C, Piso 7, Oficina 704, San Isidro, Lima 27, Perú. RUC: 20425853865. Reg. Importador: 02350-12-JUE-DIGESA. Tel.: 0800-54744. E-mail Latinoamérica: servicio.clientes@mattel.com. Mattel do Brasil Ltda. - CNPJ : 54.558.002/0001-20 - Rua Verbo Divino, 1488 - 2º. Andar - 04719-904 - Chácara Santo Antônio - São Paulo - SP - Brasil. Serviço de Atendimento ao Consumidor: fone 0800 575 0780. E-mail: sac.matteldobrazil@mattel.com

Baja Truck / Camion Baja / Pojazd Baja / Грузовик Баджа / Тзтп / Kamyon Baja / Baja kisteherautó / Baja-truck / Nákladák Baja / شاحنة Baja

- ⚠ **WARNING:**
CHOKING HAZARD. - Small parts.
Not for children under 3 years.
- ⚠ **ATTENTION:**
DANGER D'ÉTOUFFEMENT. - Présence de petits éléments.
Ne convient pas aux enfants de moins de 3 ans.
- ⚠ **警告:**
のどにつまる危険 小さな部品が含まれています
3歳以下の子供には与えないで下さい。
- ⚠ **تحذير:**
غير مناسبة للأطفال دون 36 شهراً - قطع صغيرة.

⚠ **警告!**
不适合3岁以下儿童使用。
内含小零件。

ADVERTENCIA: PELIGRO DE ATRAGANTAMIENTO. Juguete no recomendado para menores de 3 años, porque contiene piezas pequeñas que podrían provocar asfixia en caso de ser ingeridas o inhaladas por el/ la niño/a.

ATENÇÃO! Não indicado / não recomendável para crianças menores de 3 (três) anos por conter parte(s) pequena(s) que pode(m) ser engolid(a)s ou aspirada(s) podendo provocar asfixia.

AVVERTENZA: Contiene pezzi di piccole dimensioni.

ACHTUNG: Kleine Teile.

OSTRZEŻENIE: Małe części. Niebezpieczeństwo zadławienia.

WAARSCHUWING: Kleine onderdelen.

ΠΡΕΔΥΠΡΕΦΔΗΝΕ: Μελκιε δεταλιε.

ADVARSEL: Indeholder små dele.

VARNING: Smådelar

ADVARSEL: Små deler

VAROITUS: Pieniä osia

ΠΡΟΣΟΧΗ: Περιλαμβάνονται μικρά κομμάτια.

UYARI: Küçük parçalar.

UPOZORNENÍ: Malé díly

UPOZORNENIE: Malé časti

FIGYELMEZTETÉS: Kis alkatrészek.





BAJA TRUCK · CAMION BAJA



Are you ready for the next challenge?
Prêt pour le prochain défi?

¿Estás listo para el siguiente desafío?
Você está pronto para o próximo desafio?
Bist du bereit für die nächste Herausforderung?
Вы готовы к следующему испытанию?

MORE TO BUILD! ENCORE PLUS À CONSTRUIRE!

¡MÁS PARA CONSTRUIR! · MAIS PARA CONSTRUIR!
MEHR ZUM BAUEN! · КОНСТРУИРУЙ БОЛЬШЕ!



GVM27



GYG35



GYG37



GYG36



GVM26



Set(s) sold separately and subject to availability. / Ensemble(s) vendu(s) séparément. Certains produits peuvent ne pas être commercialisés. / Se vende(n) por separado y está(n) sujeto(s) a disponibilidad. / Conjunto(s) vendido(s) em separado e sujeito(s) à disponibilidade. / Set in vendita separatamente, secondo disponibilità. / Das/Die Set(s) sind separat erhältlich. / Zestaw(y) sprzedawany(e) oddzielnie w zależności od dostępności. / Set(s) apart verkrijgbaar en afhankelijk van beschikbaarheid. / Набор(-ы) продаются отдельно, при наличии. / Sæt sælges separat og så længe lager haves. / Seten säljs separat så länge lagret räcker. / Settet/settene selges separat så langt lageret rekker. / Pakkaus/pakkaukset myydään erikseen, saatavuus voi vaihdella. / Το(α) σετ πωλούνται ξεχωριστά και ανάλογα με τη διαθεσιμότητα. / Setler ayrı olarak satılır ve stoklarla sınırlıdır. / Set (sety) se prodává (prodávají) samostatně dle aktuální nabídky. / Süpraval-/y sa predáva(jú) samostatne a podľa dostupnosti. / A készlet(ek) külön kapható(k), az elérhetőség változhat. / セット商品は別売りになります。在庫状況は別途ご確認をお願いします。 / تُباع المجموعة أو المجموعات على حدة وتُخضع لتوافرها.

每套单独发售，按供货情况决定。



1186 MJ, 1, NL

© 2020, MEGA Brands & ™ MEGA Brands; HOT WHEELS and associated trademarks and trade dress are owned by and used under license from Mattel. HOT WHEELS ainsi que les marques et designs y afférents appartiennent à, et sont utilisés sous licence de Mattel. © 2020 Mattel.

Printed in China / Imprimé en Chine AD-GYG34-01A

Mattel Canada Inc. Mississauga,
Ontario L5R 3W2.

MADE IN CHINA. FABRIQUÉ EN CHINE.
FABRICADO NA / HECHO EN CHINA.
ИЗГОТОВЛЕНО В КИТАЕ. ÇIN'DE ÜRETİLMİŞTİR.
صنع في الصين

