



POKÉMON



BUILD & SHOW PIKACHU
EVOLUTION TRIO
CRÉER ET MONTRER LES TROIS
ÉVOLUTIONS DE PIKACHU

CONSTRUYE Y MUESTRA - EVOLUCIONES DE PIKACHU / CONSTRUA E MOSTRE - EVOLUÇÕES DO PIKACHU

GYH06



Build Construisez

Construye | Constrói
Bauen | Стройте



Share | Partagez

Comparte | Partilha
Teilen | Делитесь



Easy-to-follow steps!

Des instructions faciles à suivre !

¡Pasos fáciles de seguir!
Passos fáceis de seguir!
Einfache Schritte!
Простые действия!



Devices not included | Appareils non inclus | Dispositivos no incluido | Dispositivos
não incluídos | Geräte nicht enthalten | Устройства не входят в комплект

megaunboxed.com



1



2x



2x

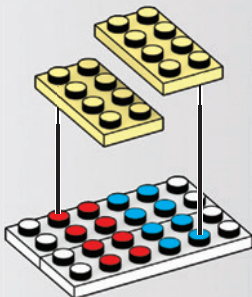

2



4x

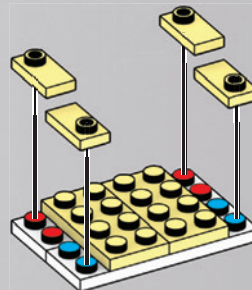

3



4x

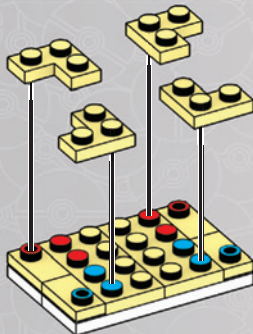

4



4x

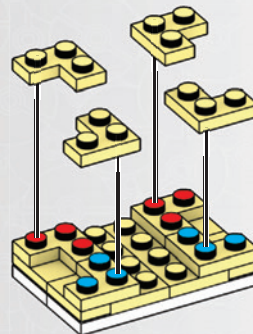

5



2x



1x

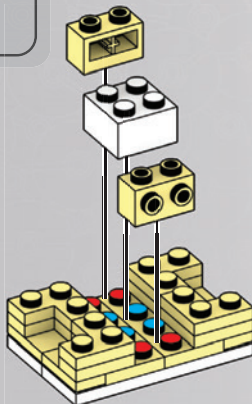

6



4x



2x

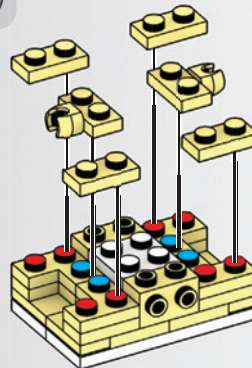

7



4x

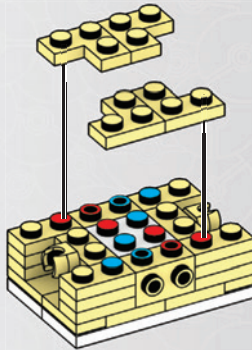

8



4x

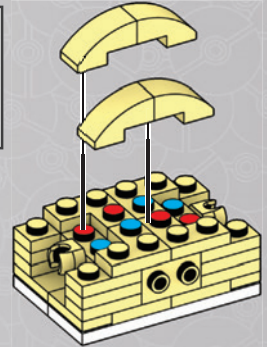

9



4x

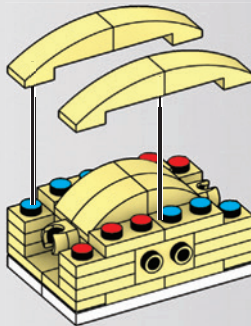

1

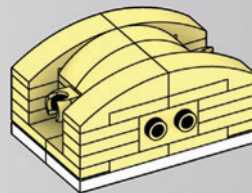

2

10



4x



2x

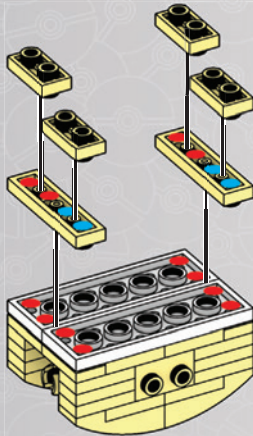

1

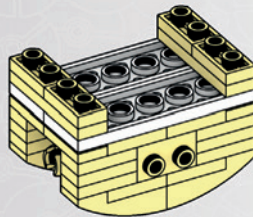

2

11



4x



2x

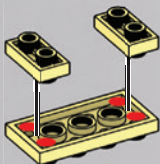

1

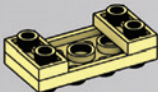

2

x2

12



1x

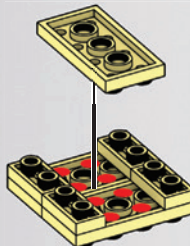

1

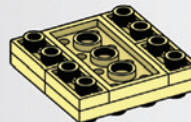

2

13



2x

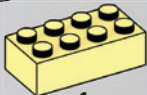

1x

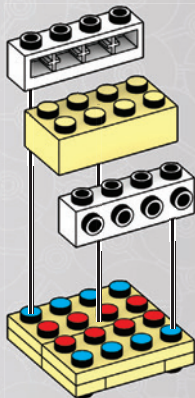

14

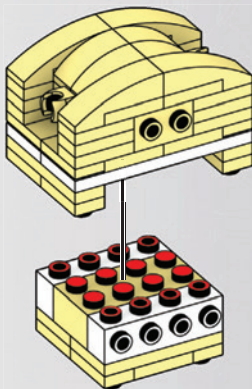

1

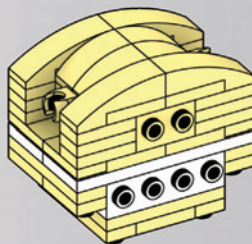

2

15



4x



8x

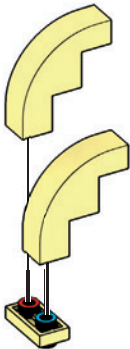

1



2

x4

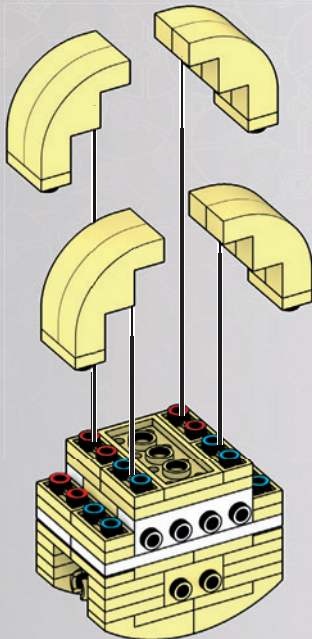

1

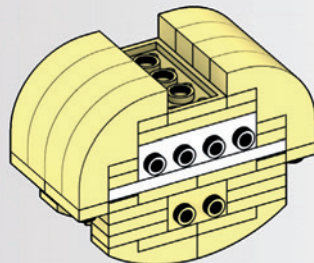

2

16



2x

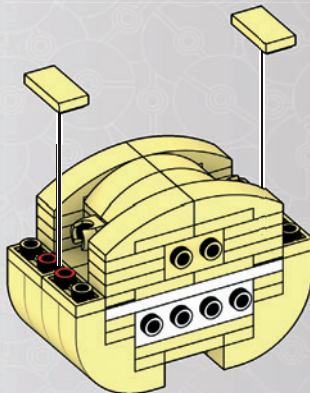

17



4x

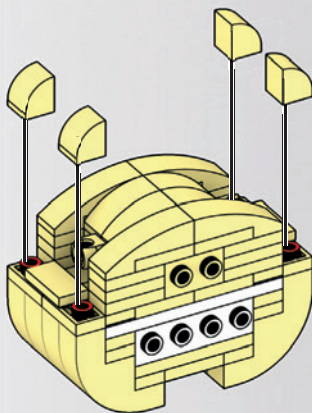

1

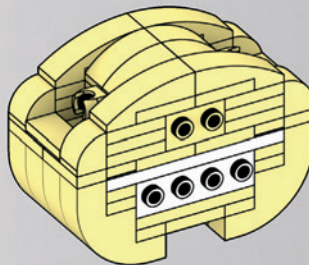

2

18



1x

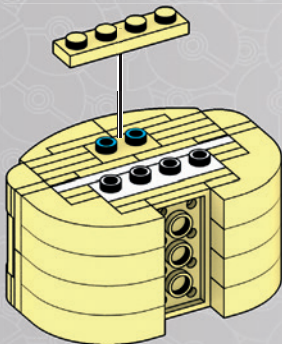

19



1x

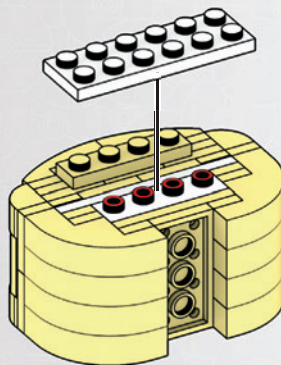

20



1x



2x

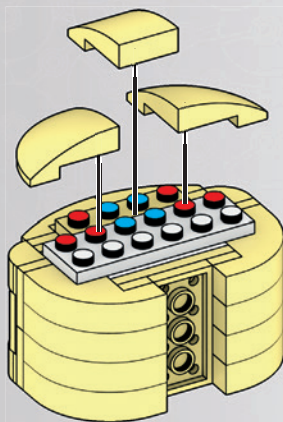

21

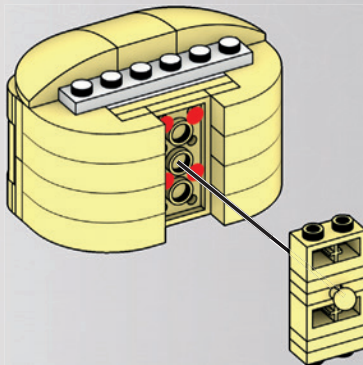
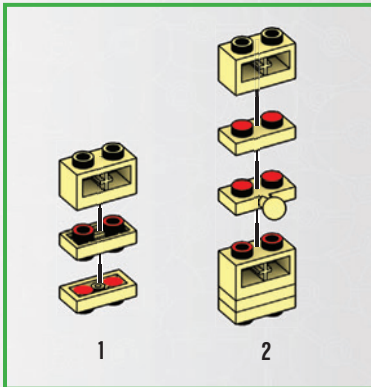
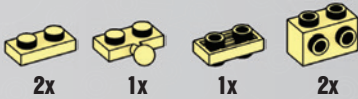

22



1x



2x



1x

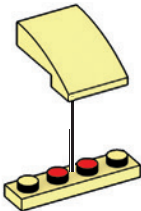

1

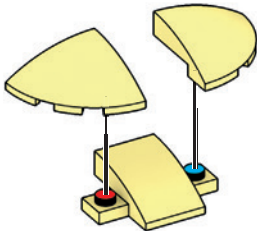

2

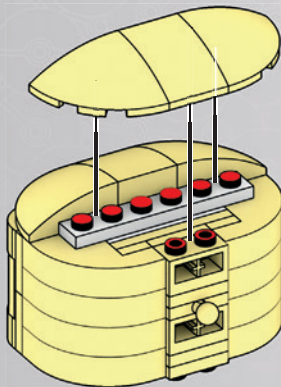

1

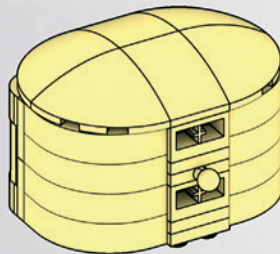

2

23



1x

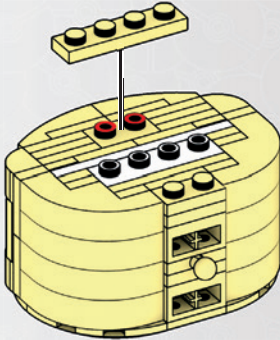

24



1x

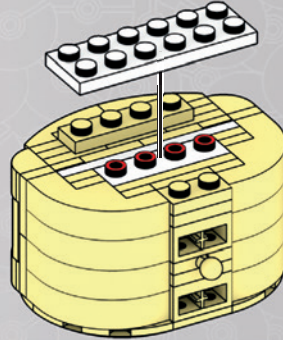

25



1x



1x



1x

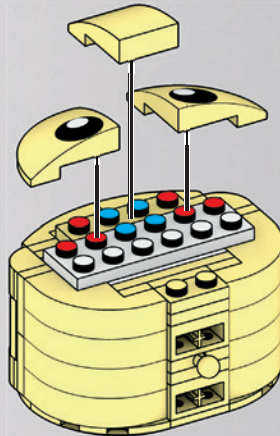

26



1x



1x



1x



1x

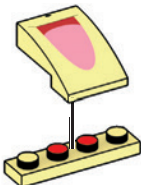

1

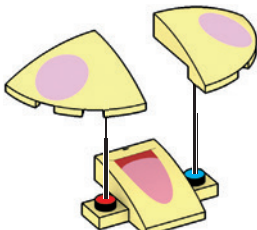

2

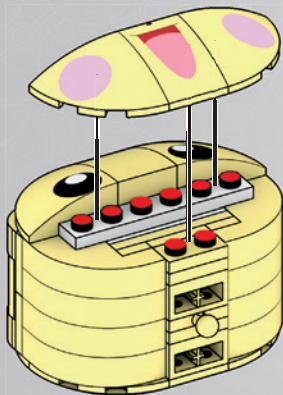

1

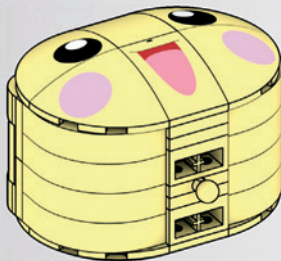
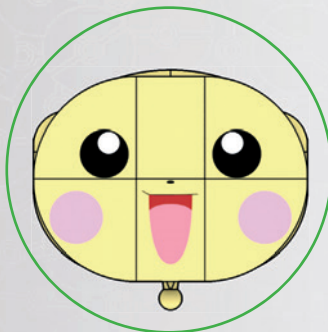

2

27

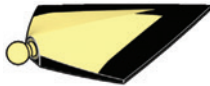
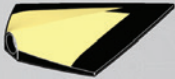

x2

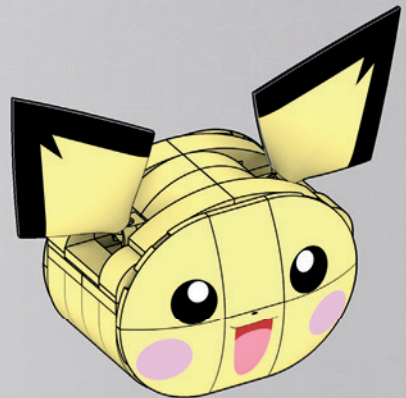
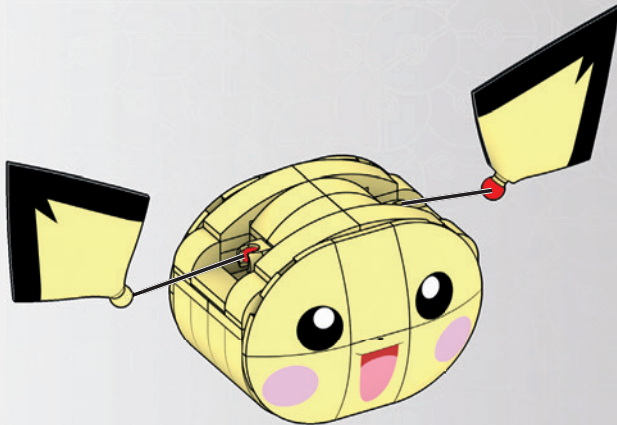

28



2x

1x

1x

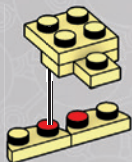
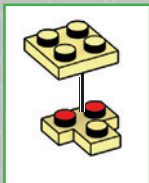

29



2x

1x

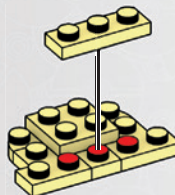

30

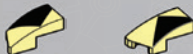

1x

1x

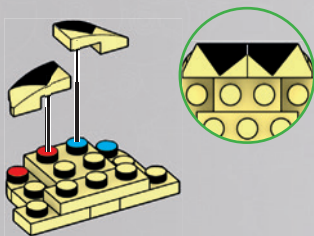

31



2x

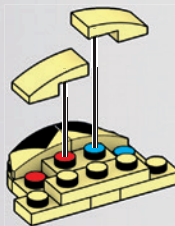
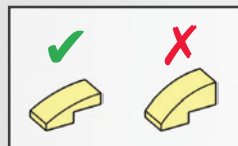

1



2

32



33

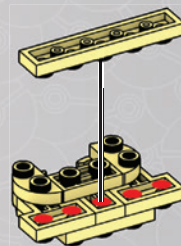
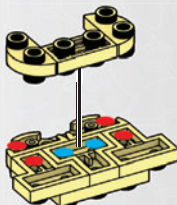
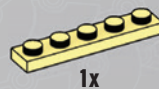

1

2

34

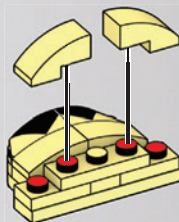
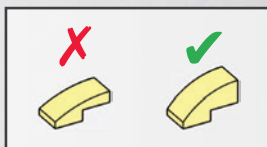

35



1x



1x



1x



2x

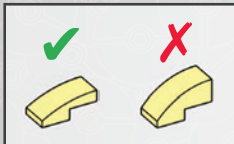

1

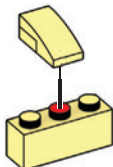

2

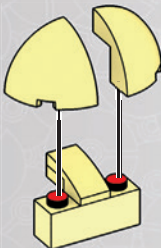

36

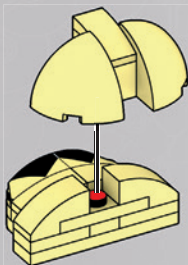

1



2

37



1x

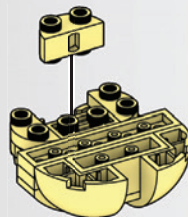

38



2x

1x

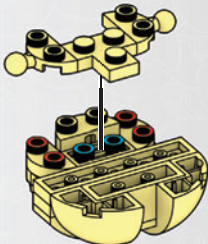

39



2x

2x

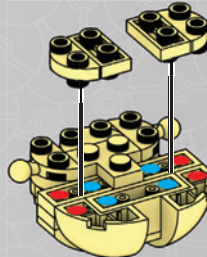

40

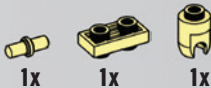

1x

1x

1x

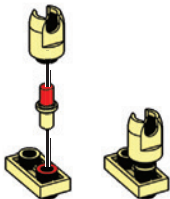

1

2

41



2x

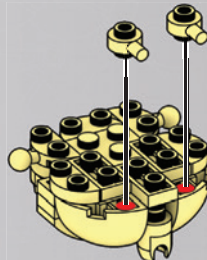
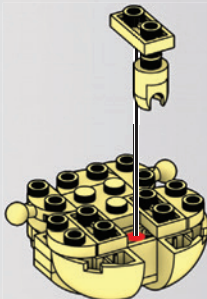

42

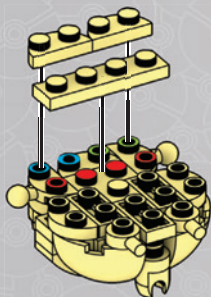

43

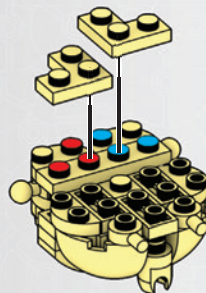

44

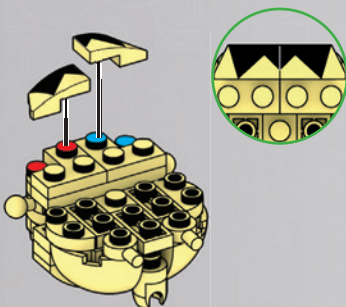

45

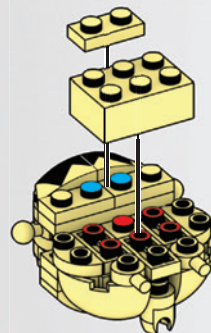
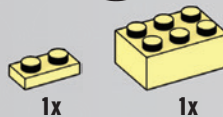

46



2x

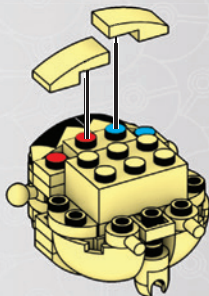

47



1x



1x



2x

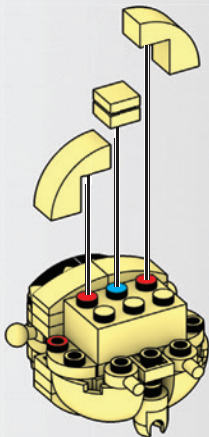

48



1x



2x

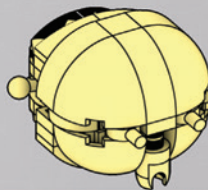
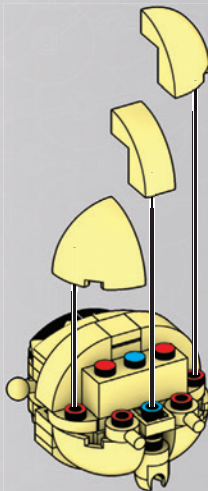

1

2

49



2x



2x



2x

50

x2

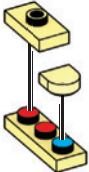

1



2

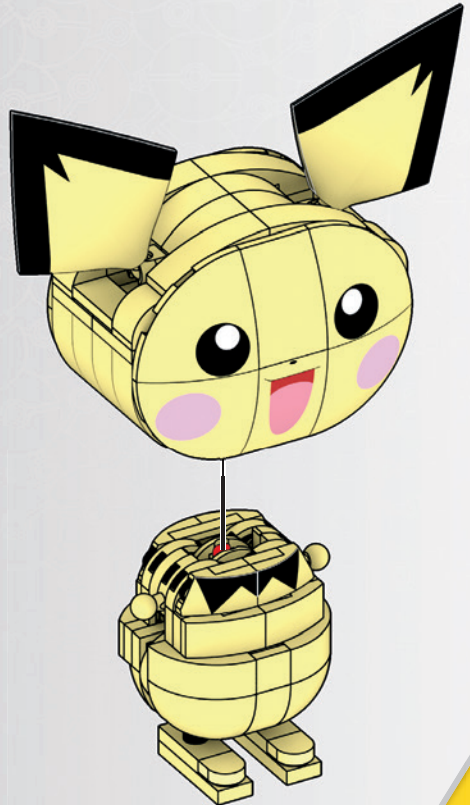
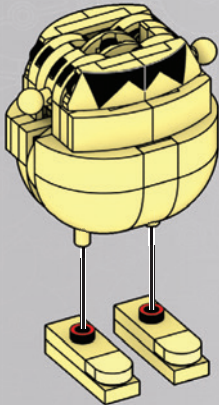

51



2x



2x



2x

x2

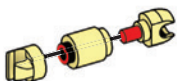

1



2

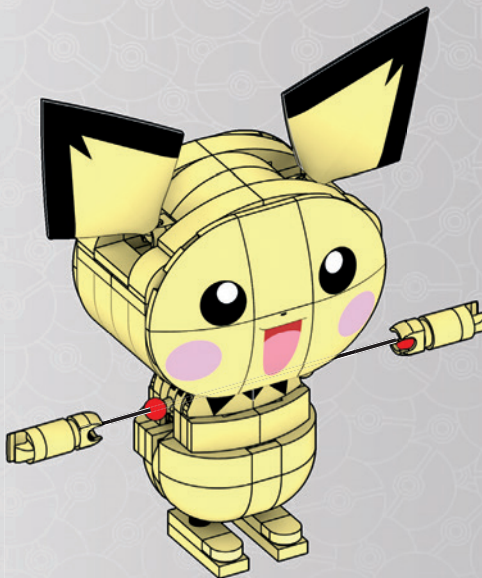

1

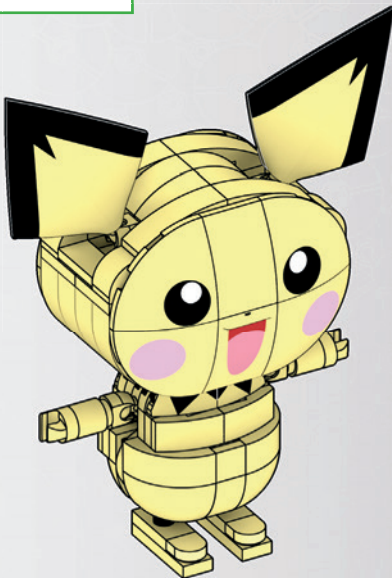

2



3

52



1x



1x



1x



1



2



3

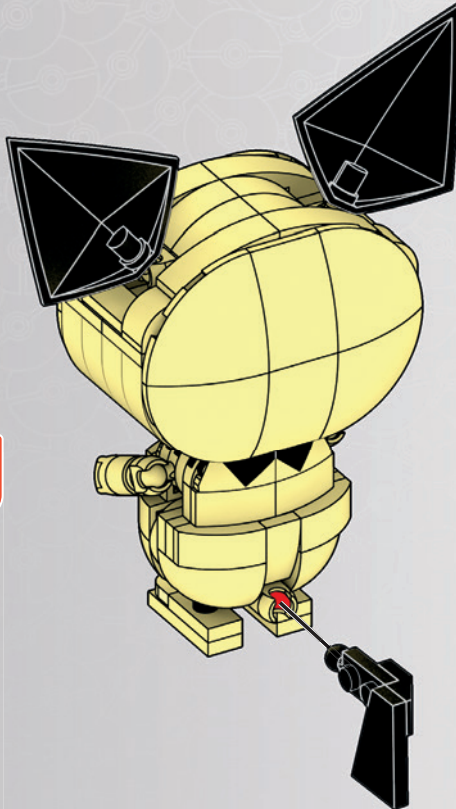

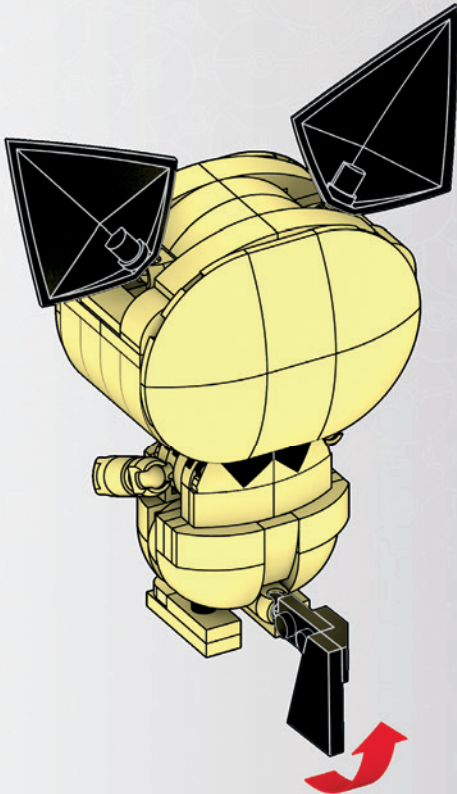

1

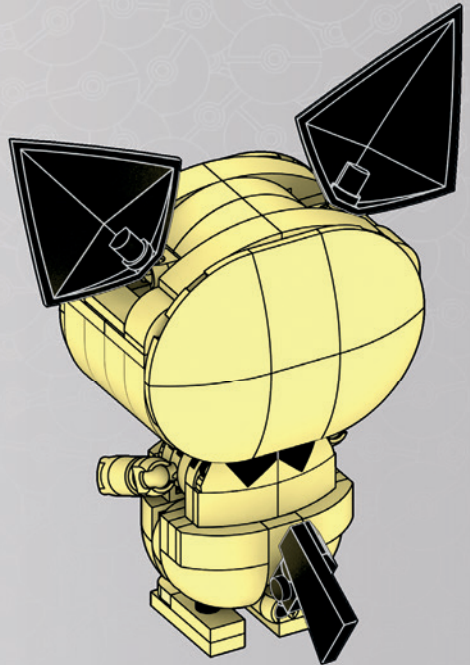

2

54

1x

1x

2x

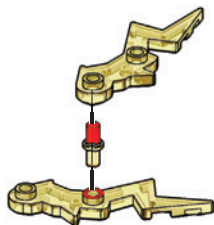

1



2



3



4



1

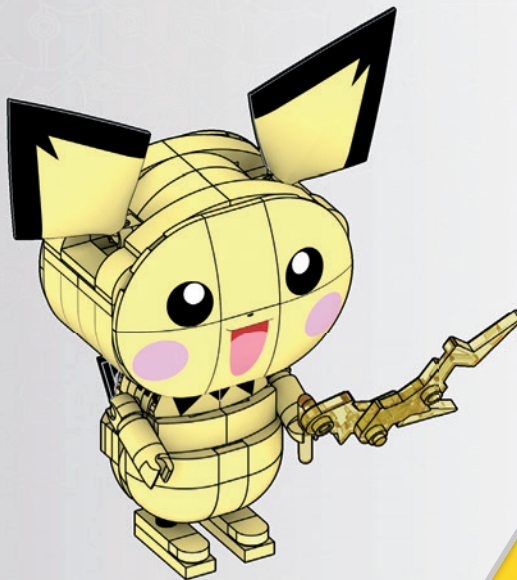

2

55

1x

1x

2x

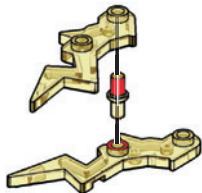

1



2



3



4

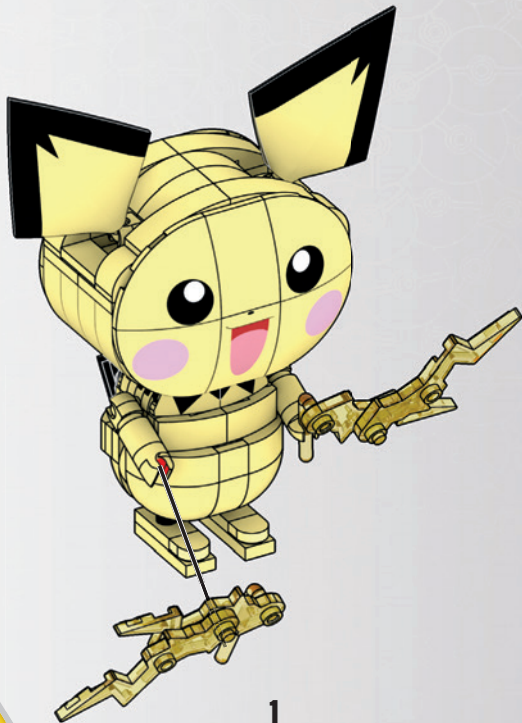

1



2

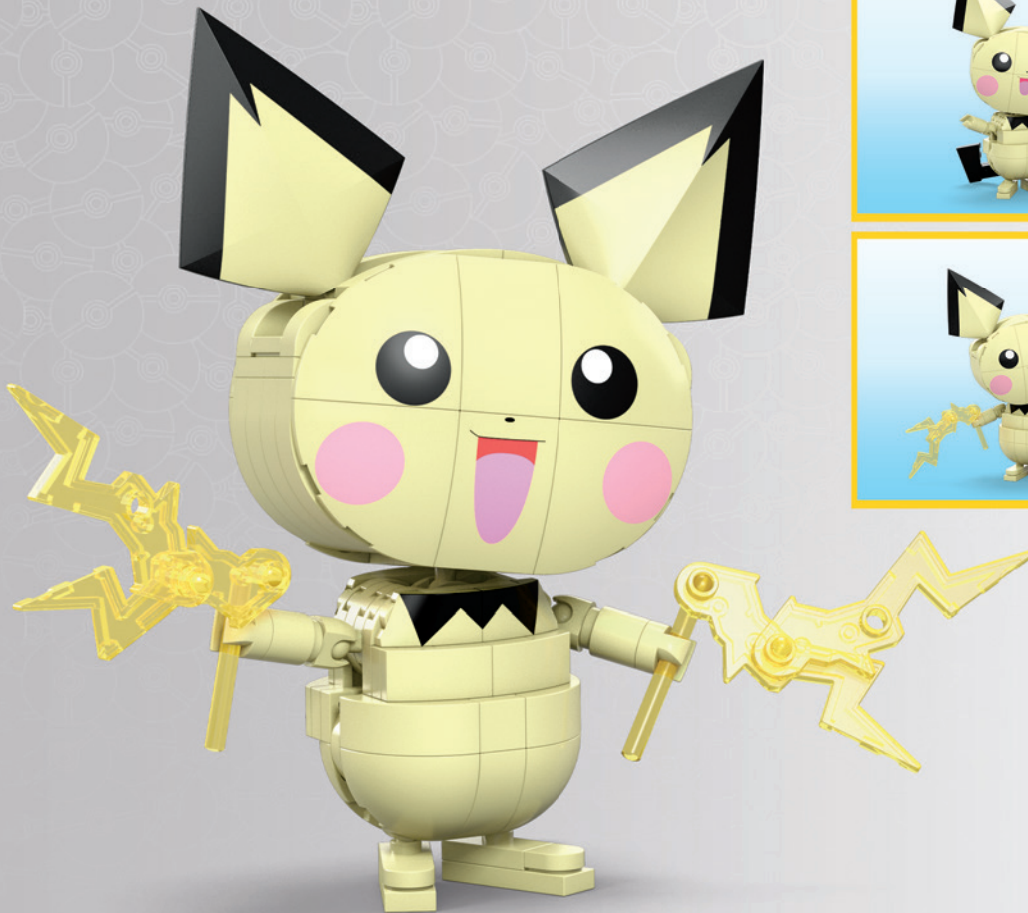

**POSE IT! / VARIEZ LES
POSES! / ¡PÓSALO!
VOCÊ PODE POSAR!
LÄSST SICH IN COOLE
POSEN BRINGEN!
МЕНЯЙ ПОЗЫ!**



BUILD & SHOW PIKACHU EVOLUTION TRIO
CRÉER ET MONTRER LES TROIS ÉVOLUTIONS DE PIKACHU
CONSTRUYE Y MUESTRA - EVOLUCIONES DE PIKACHU



PICHU

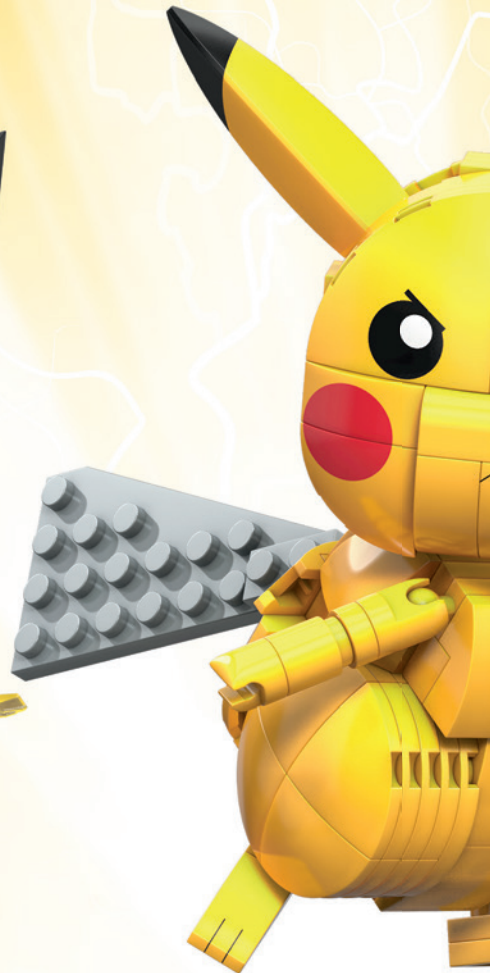



PIKACHU



RAICHU

2x
AM76204CS



1x
AM07223CS



2x
AM03328CS



2x
AM17003ZD



1x
AM17003CS



2x
AM78297CS



2x
AM78291CS



2x
AM80010CS



1x
AM78275CS



2x
AM80144CS



4x
AM07659CS



2x
AM78296CS



4x
AM79375CS



4x
AM78391CS



2x
AM80011CS



2x
AM022501CS



4x
AM73758CS



2x
AM07590CS



7x
AM09393CS



17x
AM16680CS



1x
AM78397CS



2x
AM78277CS



1x
AM78276F



1x
AS-GYH06-11



1x
AS-GYH06-12



1x
AS-GYH06-13



1x
AS-GYH06-14



5x
AM78486CS



6x
AM17788CS



1x
AM72002F



1x
AM78281CS



4x
AM17502CS



3x
AM16682CS



3x
AM01314CS



14x
AM15484CS



4x
AM18293CS



1x
AM03773CS



1x
AM19898F



1x
AM09023E



8x
AM72257CS



3x
AM17021CS



1x
AS-GYH06-10



1x
AM16384CS



2x
AM77738ZD



4x
AM19324CS



4x
AM80634CS



1x
AM03873CS



2x
AM17503E



7x
AM09593CS



1x
AM09033CS



5x
AM09493CS



1x
AM07475CS



4x
AM78389ZD



4x
AM07230CS



1x
AS-GYH06-06



1x
AS-GYH06-07



1x
AS-GYH06-08



1x
AS-GYH06-09



2x
AS-GYH06-05



4x
AM01480E



**Missing pieces?
Pièces manquantes?**

¿Partes faltantes? • Perdeu peças?
Fehlen Teile? • Не хватает деталей?

support.megabrand.com

ATTENTION : DANGER
D'ÉTOUFFEMENT. - PRÉSENCE DE PETITS
ÉLÉMENTS. NE CONVIENT PAS AUX ENFANTS DE
MOINS DE 3 ANS.

ATENÇÃO! NÃO INDICADO / NÃO
RECOMENDÁVEL PARA CRIANÇAS MENORES DE 3
(TRÊS) ANOS POR CONTER PARTE(S) PEQUENA(S)
QUE PODE(M) SER ENGOLIDA(S) OU ASPIRADA(S)
PODENDO PROVOCAR ASFIXIA.

警告:

のどにつまる危険 小さな部品が含まれています
3歳以下の子供には与えないで下さい。

警告!
不适合3岁以下儿童使用。
内含小零件。

⚠ WARNING : CHOKING HAZARD. - Small parts.

Not for children under 3 years.

ADVERTENCIA: PELIGRO DE ATRAGANTAMIENTO. Juguete no recomendado para menores de 3 años, porque contiene piezas pequeñas que podrían provocar asfixia en caso de ser ingeridas o inhaladas por el/la niño/a.

AVVERTENZA: Contiene pezzi di piccole dimensioni.

ACHTUNG: Kleine Teile.

OSTRZEŻENIE: Małe części. Niebezpieczeństwo zadławienia.

WAARSCHUWING: Kleine onderdelen

ПРЕДУПРЕЖДЕНИЕ: Мелкие детали.

ADVARSEL: Indeholder små dele.

WARNING: Små delar

ADVARSEL: Små deler

VAROITUS: Pieniä osia

ΠΡΟΣΟΧΗ: Περιλαμβάνονται μικρά κομμάτια.

UVARI: Kicsi darabok.

UPOZORNĚNÍ: Malé díly

UPOZORNENIE: Malé části

FIGYELMEZTETÉS: Kis alkatrészek.



0-3

تحذير:

غير مناسبة للأطفال دون 36 شهراً - قطع صغيرة.

Build & Show Pikachu Evolution Trio / Créer et montrer les trois évolutions de Pikachu / Construye y muestra - Evoluciones de Pikachu / Construa e mostre - Evoluções do Pikachu / Costruisci e mostra Pikachu Evolution Trio / Bauen & Zeigen Pikachu Evolution Trio / Buduj i pokaz Pikachu zestaw trzech form / Bouw en laat Pikachu Evolution Trio zien / Построй и покажи Pikachu Тройная Эволюция / Κατασκευή & Εμφάνιση Pikachu Evolution Trio / Pikachu Evrim Üçlülüsünü Birleştir ve Göster / Pikachu Evolução trio építés és megjelenítése / Bygg och visa Pikachu utvecklings-trio / Rakenna & näytä Pikachu-evoluutiokolmikikko / Byg og vis Pikachu udviklingstrio / Bygg & Vis Pikachu Evulusion Trio / Sestavte a předvedte trojici figurek Pikachu Evolution / Vytvorte a ukážte evolučné trio Pikachu / بناء وعرض تطور Pikachu الثلاثي

Mattel Europa B.V., Gondel 1, 1186 MJ Amstelveen, Nederland. Mattel U.K. Limited, The Porter Building, 1 Brunel Way, Slough SL1 1FQ, UK. Mattel France, Parc de la Cerisaie, 1/3/5 allée des Fleurs, 94260 Fresnes Cedex. N° Cristal 0969 36 99 99 (Numéro non surtaxé) ou www.lesjouetsmattel.fr Mattel Belgium, Trade Mart, Atomiumsquare, Bogota 202 – B 275, 1020 Brussels. Gratis nummer België: 0800 – 16 936 - Gratis nummer Luxemburg: 800 - 22 784 -Gratis nummer Nederland: 0800 - 262 88 35. Deutschland : Mattel GmbH, Solmsstraße 4, D-60486 Frankfurt am Main. Schweiz: Mattel AG, Kirchstrasse 24, CH-3097 Liebefeld. Österreich: Mattel Ges.m.b.H., Campus 21, Liebermannstraße A01 404, A- 2345 Brunn/Gebrige. Mattel Italy Srl, Via Bracco, 6-MAC 6, 20159 Milano, Italy. Servizio assistenza clienti: Customersrvitalia@mattel.com - Numero verde 800 11 37 11. Mattel España, S.A., Aribau 200. 08036 Barcelona. cservice.spain@mattel.com Tel: 900 102 390 http://www.service.mattel.com/es. Mattel East Asia Ltd., Room 503-09, North Tower, World Finance Centre, Harbour City, Tsimshatsui, HK, China. Tel.: (852) 3185-6500. Diimport & Diedarkan Oleh: Mattel Continental Asia Sdn Bhd. Level 19, Tower 3, Avenue 7, No. 8 Jalan Kerinchi, Bangsar South, 59200 Kuala Lumpur, Malaysia. Mattel South Africa (PTY) LTD, Office 102 I3, 30 Melrose Boulevard, Johannesburg 2196. Dystributor: Mattel Poland Sp. z o.o., Warsaw Trade Tower 34 p., ul. Chłodna 51, 00-867 Warszawa. Mattel Australia Pty. Ltd., 658 Church St., Richmond, Victoria, 3121. Consumer Advisory Service - 1300 135 312. Mattel AEBE, Εθνάρχου Μακαρίου 1, Κτήριο Κ-2, ΤΚ 17561, Παλαιό Φάληρο. Mattel Oyuncakçılık Tic. Ltd. Şti. İçerenköy Mah., Erikut Sok. A Blok No:12 Üner Plaza Kat:9-10 34752 Ataşehir İstanbul. Tel: 0216 570 75 00. Импортёр/Уполномоченная организация: ООО "МАТТЕЛ" Российская Федерация, 105120 Москва, 2-й Сыромятинский переулок,1; +7 495 287 79 39. Mattel Czech Republic s.r.o., The Forum, Václavské nám. 19, 11000 Praha1. Mattel, 333 Continental Boulevard, El Segundo, CA 90245, USA. Consumer Services: 1-800-465-MEGA (6342). Mattel Canada Inc., Mississauga, Ontario L5R 3W2. Consumer Services: You may call us free at/ Composez sans frais le 1-800-524-8697. Importado y distribuido por Mattel de México, S.A. de C.V., Miguel de Cervantes Saavedra No. 193, Pisos 10 y 11, Col. Granada, Alcaaldia Miguel Hidalgo, C.P. 11200, México, Ciudad de México. R.F.C. MME-920701-NB3. Tels: 59-05-51-00 Ext. 5206 ó 01-800-463-59-89. Mattel Chile, S.A., Avenida América Vespucio 501-B, Quilicura, Santiago. Tel: 1230-020-6213. Servicio al consumidor Venezuela: Tel.: 0-800-100-9123. Mattel Argentina, S.A., Av. Libertador 1000, Piso 11 – Oficinas 109 y 111, Vicente López – Prov. Buenos Aires. Tel: 0800-666-3373. Mattel Colombia, S.A., Calle 123#7-07 P5, Bogotá. Tel.: 01800-710-2069. Mattel Perú, S.A., Av. Juan de Arona # 151, Centro Empresarial Juan de Arona, Torre C, Piso 7, Oficina 704, San Isidro, Lima 27, Perú. RUC: 20425853865. Reg. Importador: 02350-12-JUE-DIGESA. Tel.: 0800-54744. E-mail Latinoamérica: servicio_clientes@mattel.com. Mattel do Brasil Ltda. - CNPJ : 54.558.002/0001-20 - Rua Verbo Divino, 1488 - 2º. Andar - 04719-904 - Chácara Santo Antônio - São Paulo - SP - Brasil. Serviço de Atendimento ao Consumidor: fone 0800 575 0780. E-mail: sac.matteldobrazil@mattel.com



POKÉMON



GMD31



HDL84

Set(s) sold separately and subject to availability. / Ensemble(s) vendu(s) séparément. Certains produits peuvent ne pas être commercialisés. / Se vende(n) por separado y está(n) sujeto(s) a disponibilidad. / Conjunto(s) vendido(s) em separado e sujeito(s) a disponibilidade. / Set in vendita separatamente, secondo disponibilità. / Das/Die Set(s) sind separat erhältlich. / Zestaw(y) sprzedawany(e) oddzielnie w zależności od dostępności. / Set(s) apart verkrijgbaar en afhankelijk van beschikbaarheid. / Набор(ы) продаются отдельно, при наличии. / Sæt sælges separat og så længe lager haves. / Seten säljs separat så länge lagret räcker. / Settet/settene selges separat så langt lageret rekker. / Pakkaus/pakkauset myydään erikseen, saatavuus voi vaihdella. / Το(α) σετ πωλούνται ξεχωριστά και ανάλογα με τη διαθεσιμότητα. / Setler ayrı olarak satılır ve stoklarla sınırlıdır. / Set (sety) se prodává (prodávají) samostatně dle aktuální nabídky. / Súprava/-y sa predáva(jú) samostatne a podľa dostupnosti. / A készlet(ek) külön kapható(k), az elérhetőség változhat. /

セット商品は別売りになります。在庫状況は別途ご確認お願いします。 /

تباع المجموعة أو المجموعات على حدة وتخضع لتوافرها.

每套单独发售，按供货情况决定。

Mattel Canada Inc. Mississauga, Ontario L5R 3W2.
MADE IN CHINA. FABRIQUÉ EN CHINE. FABRICADO NA / HECHO EN CHINA.
ИЗГОТОВЛЕНО В КИТАЕ. ÇIN'DE ÜRETİLMİŞTİR. صنع في الصين

© D799,607, D834,105

1186 MJ, 1, NL

©2022 MEGA Brands® &™ MEGA Brands.
Printed in China / Imprimé en Chine

AD-GYH06-04

UK
CA

