

LEGO
MEGA

POKÉMON



**BUILD & SHOW PIKACHU
EVOLUTION TRIO
CRÉER ET MONTRER LES TROIS
ÉVOLUTIONS DE PIKACHU**

CONSTRUYE Y MUESTRA - EVOLUCIONES DE PIKACHU / CONSTRUA E MOSTRE - EVOLUÇÕES DO PIKACHU

GYH06



Build Construisez

Construye | Constrói
Bauen | Стройте



Share | Partagez

Comparte | Partilha
Teilen | Делитесь



Easy-to-follow steps!

Des instructions faciles à suivre !

¡Pasos fáciles de seguir!
Passos fáceis de seguir!
Einfache Schritte!
Простые действия!



Devices not included | Appareils non inclus | Dispositivos no incluido | Dispositivos não incluídos | Geräte nicht enthalten | Устройства не входят в комплект

megaunboxed.com



1



1x



1x



2x

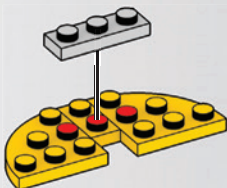

2



3x

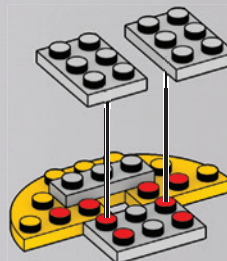

3

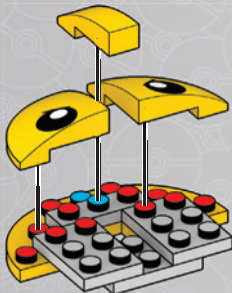

4

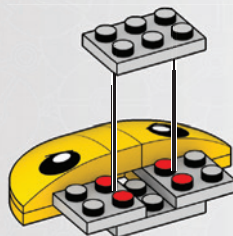
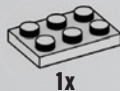

5

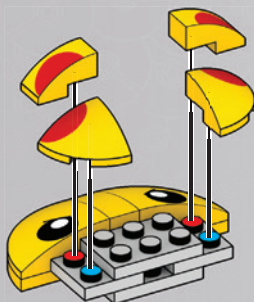

1



2

6

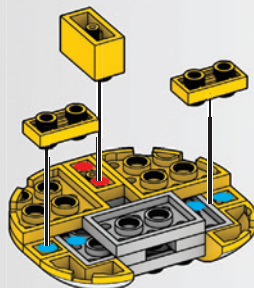

7



2x

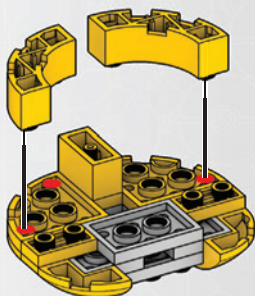

8



2x

2x

4x



x2

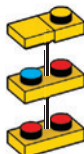

1



2

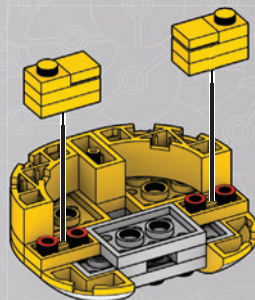

9



2x

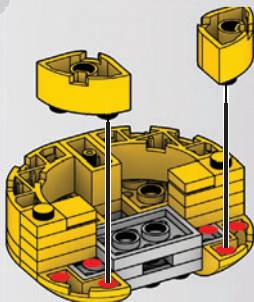

10



1x



1x

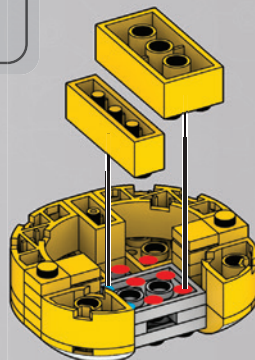

11



2x



2x

12



2x



2x



1x

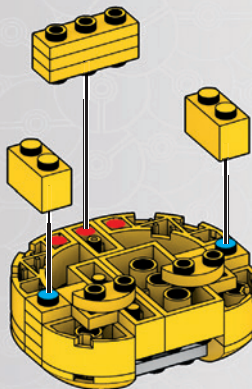
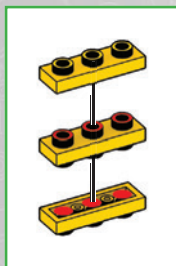
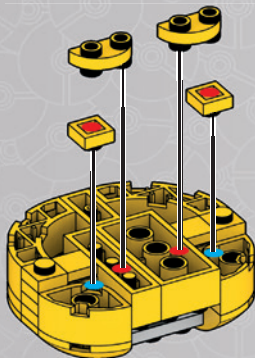

1

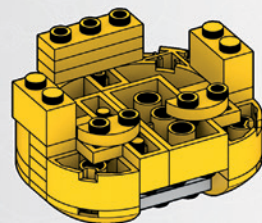

2

13



3x



1x

14



2x



2x



1x

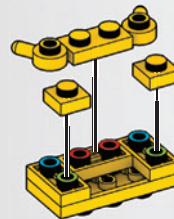
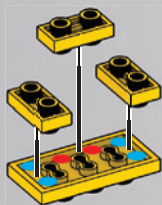
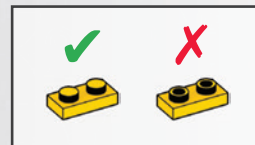

15



1x



1x

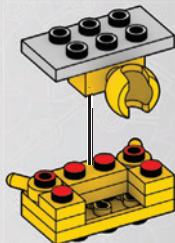

1



2

16

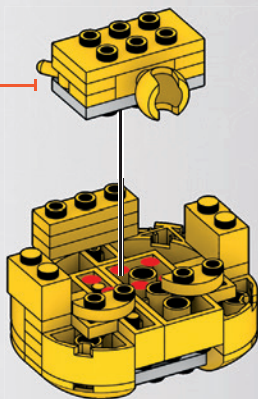

1

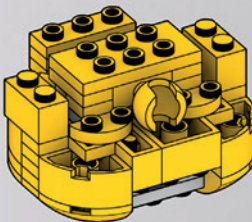

2

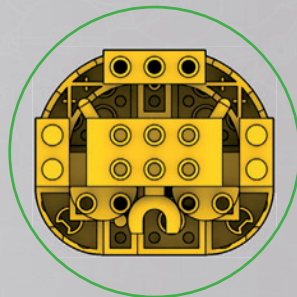

17



1x



1x

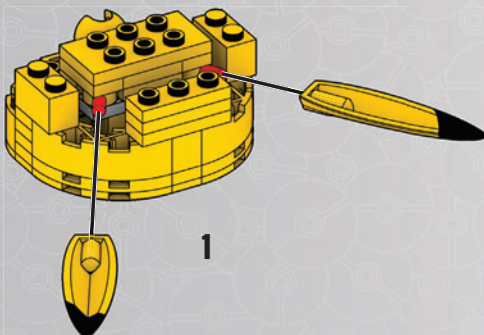
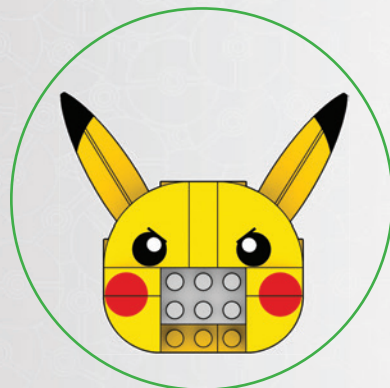

1

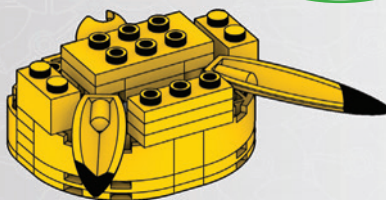

2

18



1x



2x

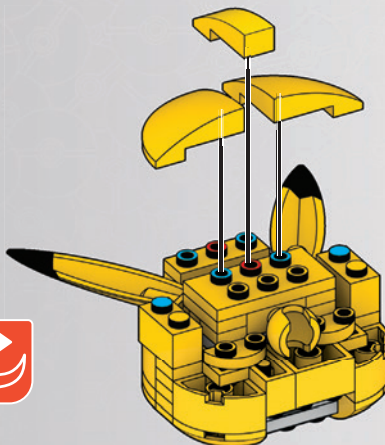

19



1x

1x

2x

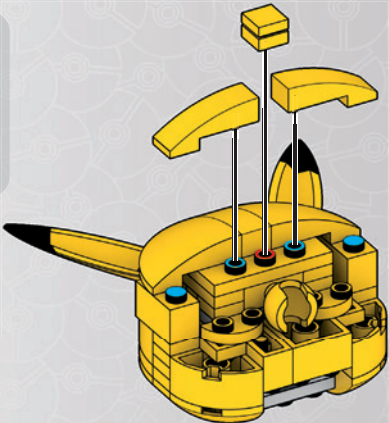
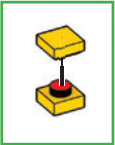

20



4x

2x

2x

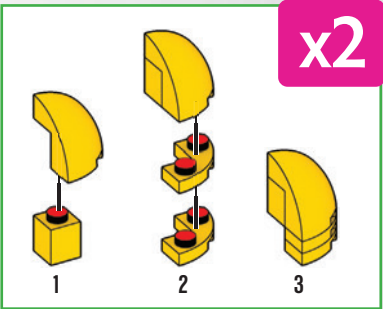

x2

1

2

3

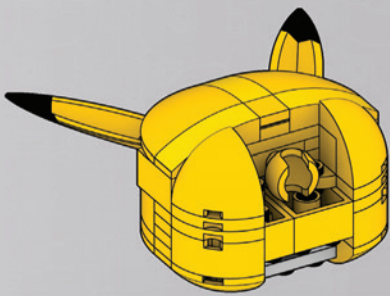
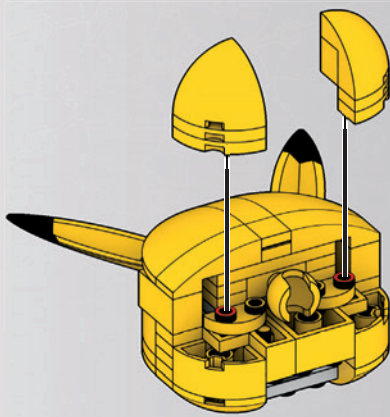

1

2

21



1x



1x

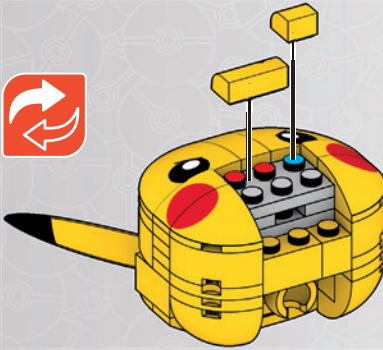

22



1x



1x

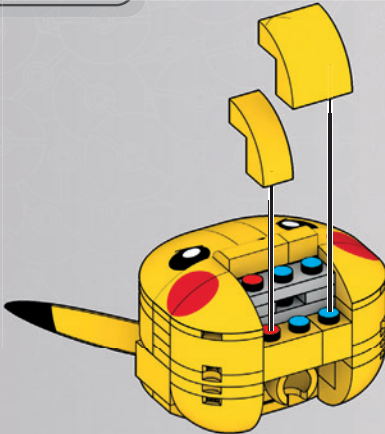

1

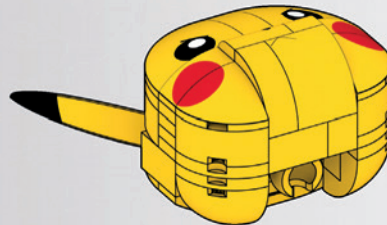
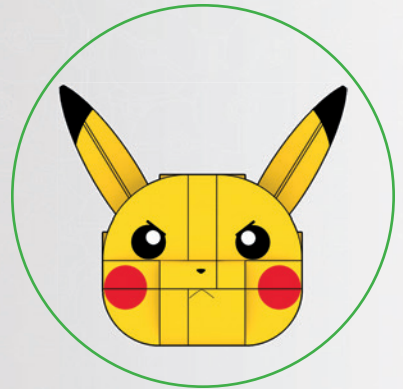

2

23

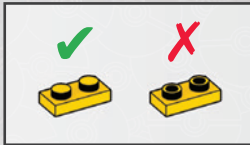

24

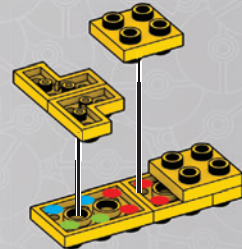

25



26

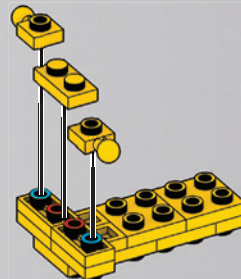
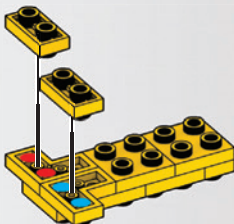
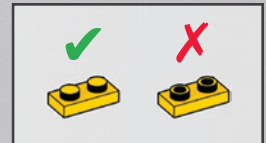

27



2x

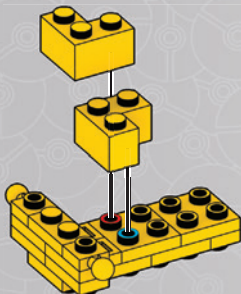

28



1x



1x



1x

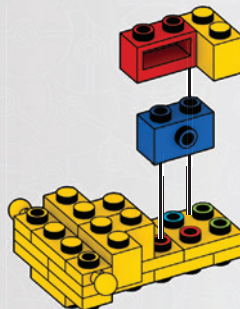

29



1x



1x

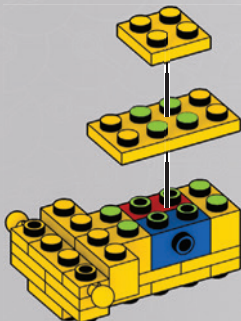

30



2x

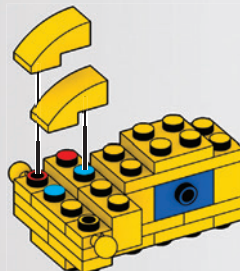

31



2x

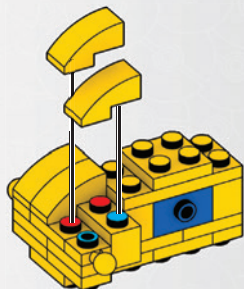

32



2x

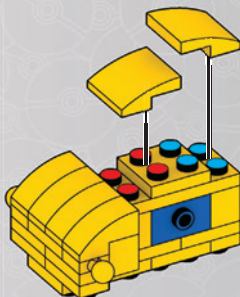

1

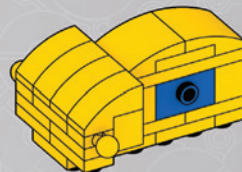

2

33



2x

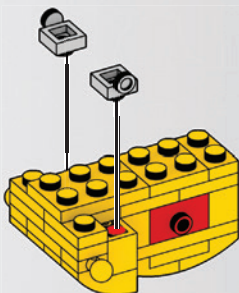

34



4x



1x

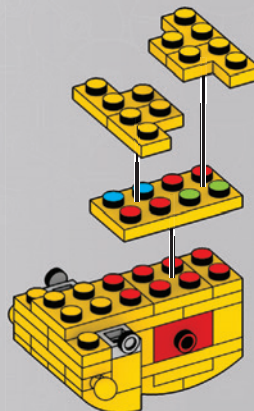

35



1x



1x

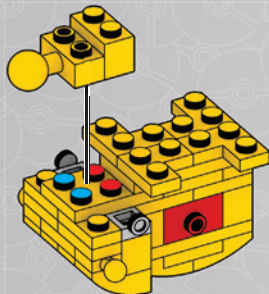

36



2x

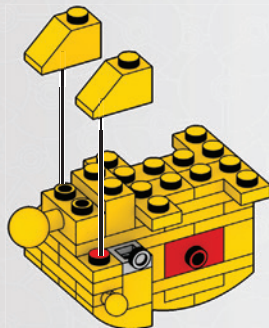

37



2x



1x

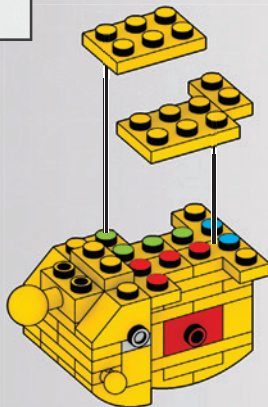
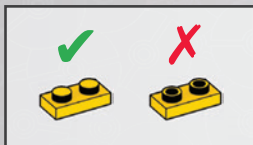

38



2x



1x

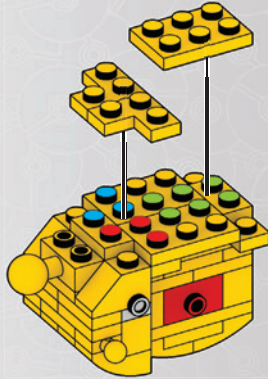

39



2x

X

✓

X

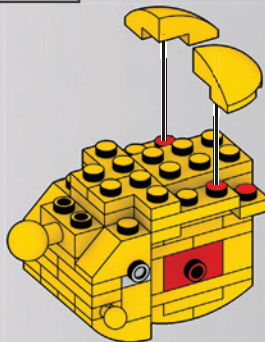

40



1x



1x

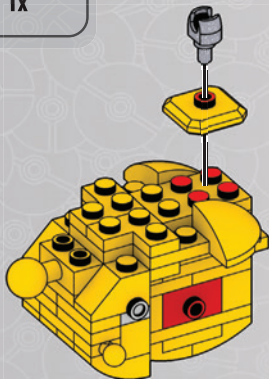

41



2x



1x

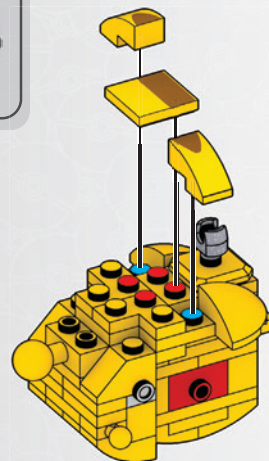

42



1x



1x

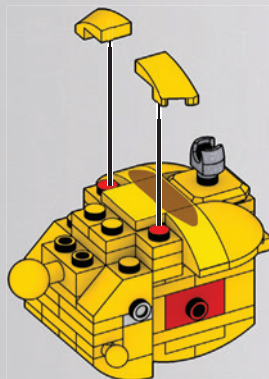

43



2x



1x



1x

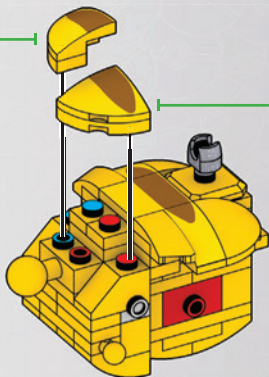
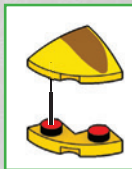

1

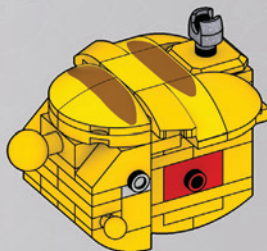

2

44



2x



2x

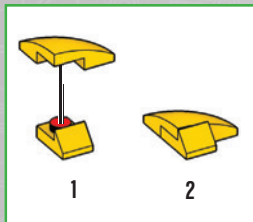

1

2

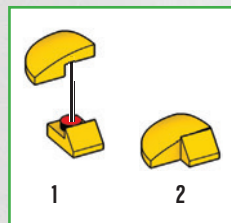

1

2

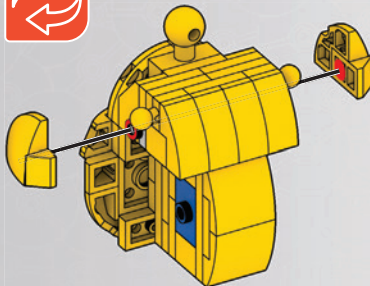

45



1x



1x

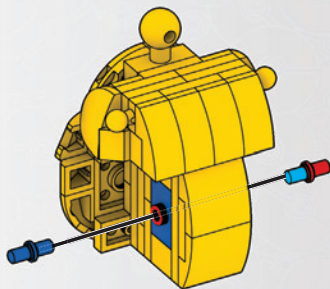

1

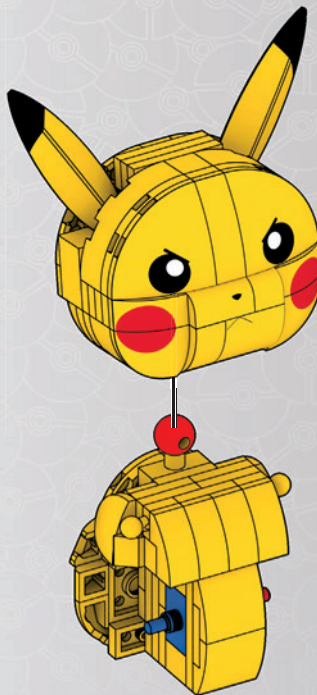

2

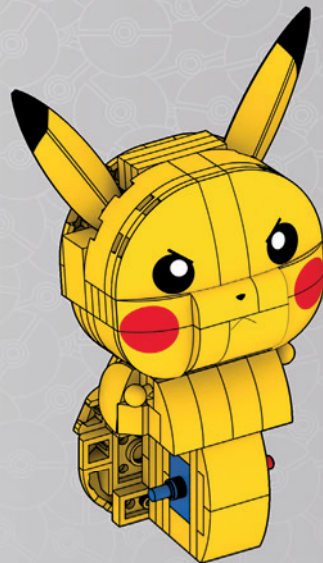

3

46



3x



1x



1x

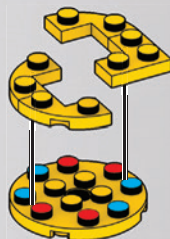

47



1x



3x



1x



48



4x

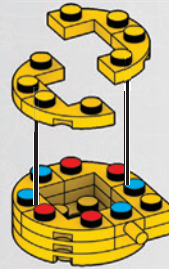

1

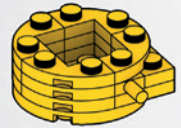

2

49



1x



2x

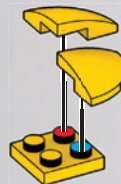

50



2x

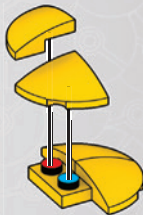

1



2

51



1x



1x

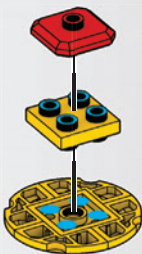

1



2

52

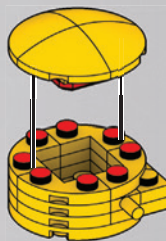

1

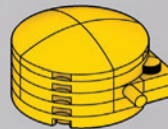

2

53



1x



1x



1x

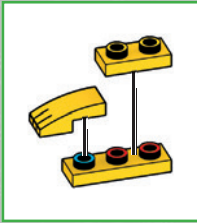

1



2

54



3x



1x



1x

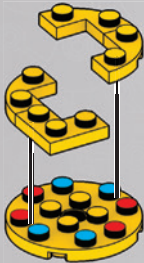

55



1x



3x



1x

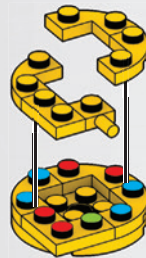

56



4x

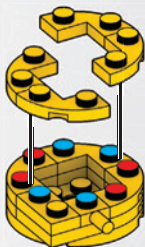

1



2

57



1x



2x

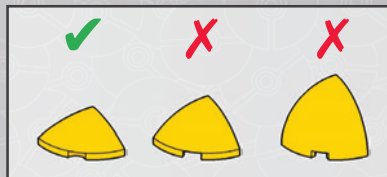

58



2x

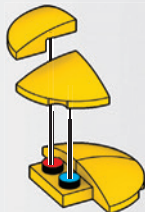
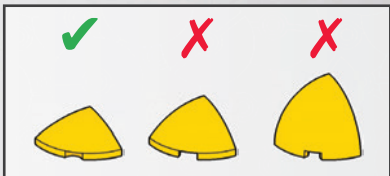

1



2

59



1x



1x



1



2

60

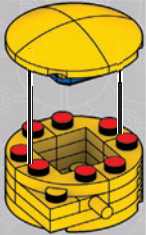

1



2

61



1x



1x



1x

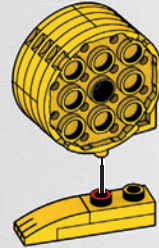
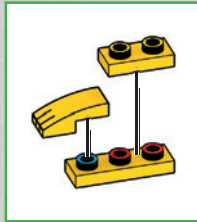
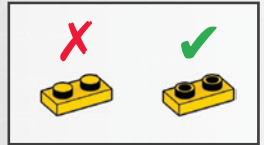

1

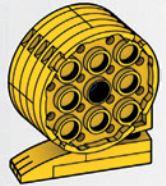

2

62

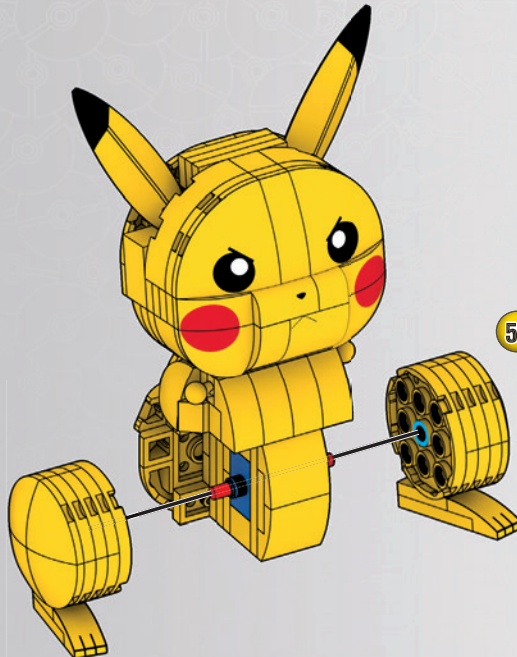

61

53

63



2x



2x



2x



2x



1

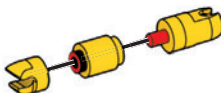

2



3

x2

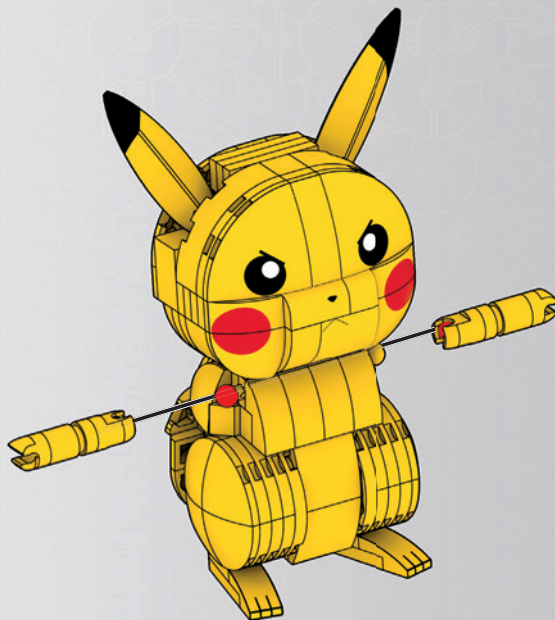

1

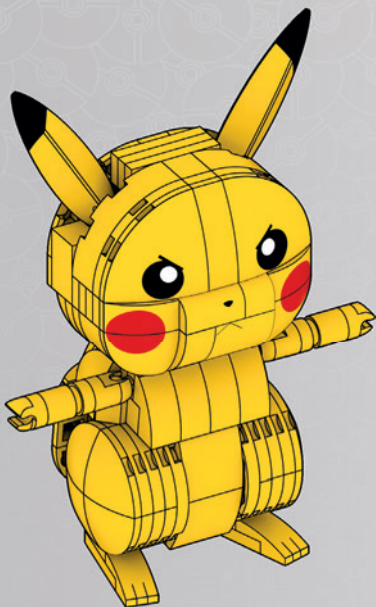

2

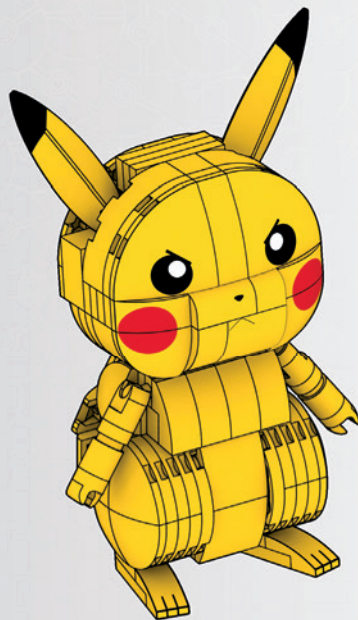

3

64

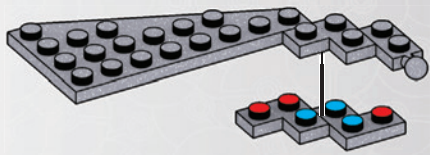

65

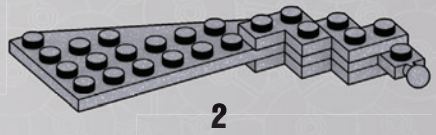

66

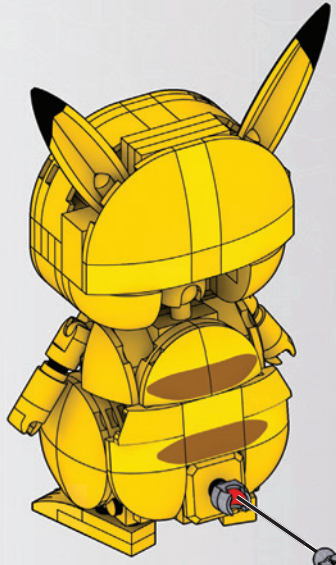

1

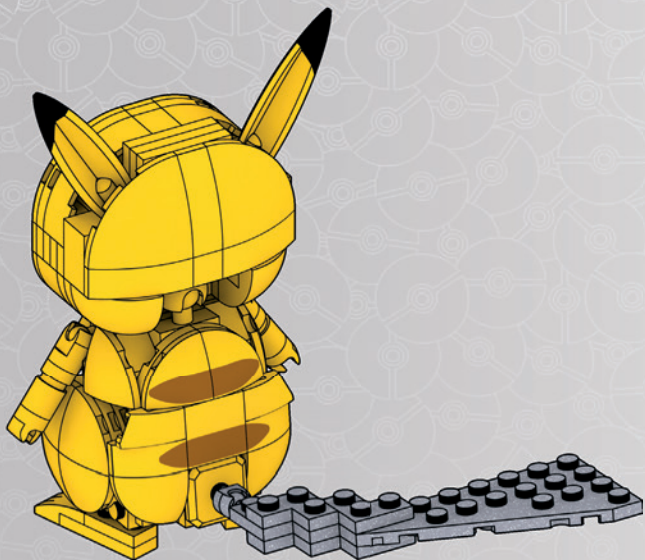

2

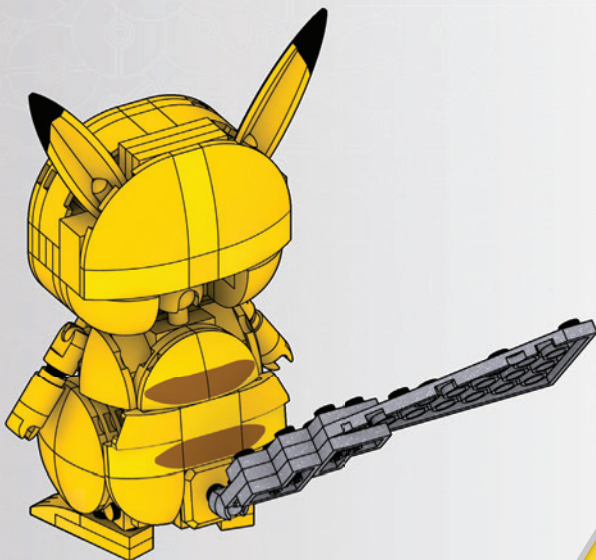

3

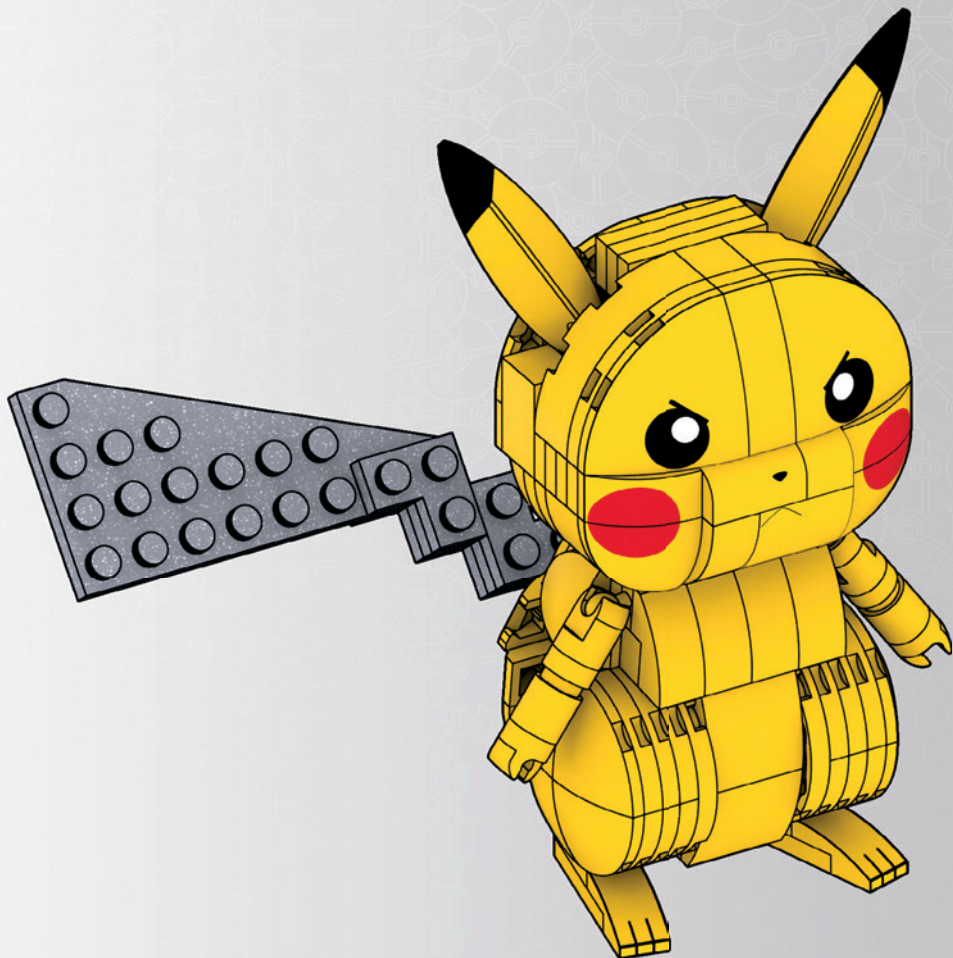



**POSE IT! / VARIEZ LES
POSES! / ¡PÓSALO!
VOCÊ PODE POSAR!
LÄSST SICH IN COOLE
POSEN BRINGEN!
МЕНЯЙ ПОЗЫ!**



1x
AM17003AMC



1x
AM17003B



2x
AM81248BYE



3x
AM07223BYE



7x
AM03328BYE



2x
AM77574BLG



1x
AM17787BYE



2x
AM79377BYE



2x
AM01312BYE



2x
AM01140BYE



1x
AM78296AWB



2x
AM78297BYE



2x
AM78275BYE



2x
AM80144BYE



2x
AM01086BYE



2x
AM19530BYE



2x
AM78391BYE



2x
AM79246BYE



11x
AM09393BYE



7x
AM16680BYE



1x
AM74427BYE



1x
AM74426BYE



4x
AM17788BYE



2x
AM01322BYE



5x
AM09013BYE



1x
AM18601AMC



1x
AM18601B



1x
AM16682BYE



26x
AM04322BYE



10x
AM15484BYE



5x
AM15484AWB



1x
AM73009AMC



1x
AM73009B



1x
AM73009BYE



4x
AM03773BYE



4x
AM01146BYE



1x
AS-GMD31-02



1x
AS-GMD31-04



2x
AS-GMD31-14



2x
AS-GMD31-11



1x
AS-GYH06-03



2x
AM74106BYE



1x
AS-GMD31-15



1x
AS-GMD31-12



1x
AS-GMD31-13



1x
AS-GMD31-03



1x
AS-GMD31-01



1x
AM79227BYE



1x
AM79796BYE



2x
AM17153BYE



2x
AM02212BYE



1x
AM78276AWB



4x
AM03772BYE



4x
AM03772BLG



4x
AM07230BYE



4x
AM72600BYE



1x
AM01314BLG



1x
AM80143BYE



1x
AS-GYH06-04



10x
AM76525BYE



2x
AM80799BYE



2x
AM80634BYE



2x
AM17056BYE



2x
AM09493BYE



1x
AM18299BYE



1x
AM18299BLG



2x
AM73003BYE



2x
AM19324BYE



1x
AM01087BYE



1x
AM09033BYE



1x
AS-GMD31-17



1x
AS-GMD31-16





1x
AS-GYH06-02



1x
AS-GYH06-01



2x
AM76367BYE



1x
AM17076AWB

Missing pieces? Pièces manquantes?

¿Partes faltantes? • Perdeu peças?
Fehlen Teile? • Не хватает деталей?

support.megabrand.com

ATTENTION : DANGER
D'ÉTOUFFEMENT. - PRÉSENCE DE PETITS
ÉLÉMENTS. NE CONVIENT PAS AUX ENFANTS DE
MOINS DE 3 ANS.

ATENÇÃO! NÃO INDICADO / NÃO
RECOMENDÁVEL PARA CRIANÇAS MENORES DE 3
(TRÊS) ANOS POR CONTER PARTE(S) PEQUENA(S)
QUE PODE(M) SER ENGOLIDA(S) OU ASPIRADA(S)
PODENDO PROVOCAR ASFIXIA.

警告:

のどにつまる危険 小さな部品が含まれています
3歳以下の子供には与えないで下さい。

警告!

不适合3岁以下儿童使用。
内含小零件。

⚠ WARNING : CHOKING HAZARD. - Small parts.
Not for children under 3 years.
ADVERTENCIA : PELIGRO DE ATRAGANTAMIENTO. Juguete no recomendado
para menores de 3 años, porque contiene piezas pequeñas que podrían
provocar asfixia en caso de ser ingeridas o inhaladas por el/la niño/a.
AVVERTENZA : Contiene pezzi di piccole dimensioni.

ACHTUNG : Kleine Teile.

OSTRZEŻENIE : Małe części. Niebezpieczeństwo zadławienia.

WAARSCHUWING : Kleine onderdelen

ПРЕДУПРЕЖДЕНИЕ : Мелкие детали.

ADVARSEL : Indeholder små dele.

VARNING : Smådelar

ADVARSEL : Små deler

VAROITUS : Pieniä osia

ΠΡΟΣΟΧΗ : Περιλαμβάνονται μικρά κομμάτια.

UYARI : Küçük parçalar.

UPOZORNĚNÍ : Malé díly

UPOZORNENIE : Malé části

FIGYELMEZTETÉS : Kis alkatrészek.



0-3

تحذير:

غير مناسبة للأطفال دون 36 شهراً - قطع صغيرة.

Build & Show Pikachu Evolution Trio / Créer et monter les trois évolutions de Pikachu / Construye y muestra - Evoluciones de Pikachu / Construa e mostre - Evoluções do Pikachu /
Costruisci e mostra Pikachu Evolution Trio / Bauen & Zeigen Pikachu Evolution Trio / Buduj i pokaż Pikachu zestaw trzech form / Bouw en laat Pikachu Evolution Trio zien / Построй и
покажи Pikachu Тройная Эволюция / Κατασκευή & Εμφάνιση Pikachu Evolution Trio / Pikachu Evrim Üçlüsünü Birleştir ve Göster / Pikachu Evolução trio építése és megjelentése /
Bygg och visa Pikachu utvecklings-trio / Rakenna & näytä Pikachu-evoluutiokolmikko / Byg og vis Pikachu udviklings-trio / Bygg & Vis Pikachu Evolution Trio / Sestavte a předvedte
trojici figurek Pikachu Evolution / Vytvorte a ukážete evolučné trio Pikachu / إنشأ وعرض تطور Pikachu الثلاثي

Mattel Europa B.V., Gonderl 1, 1186 MJ Amstelveen, Nederland. Mattel U.K. Limited, The Porter Building, 1 Brunel Way, Slough SL1 1FQ, UK. Mattel France, Parc de la Ceraise, 1/3/5 allée des Fleurs, 94260 Fresnes Cedex. N° Cristal 0969 36 99 99 (Numéro non surtaxé) ou www.lesjouetsmattel.fr Mattel Belgium, Trade Mart, Atomiumsquare, Bogota 202 - B 275, 1020 Brussels. Gratis nummer België: 0800 - 16 936 - Gratis nummer Luxemburg: 800 - 22 784 - Gratis nummer Nederland: 0800 - 262 88 35. Deutschland: Mattel GmbH, Solmsstraße 4, D-60486 Frankfurt am Main. Schweiz: Mattel AG, Kirchstrasse 24, CH-3097 Liebefeld. Österreich: Mattel Ges.m.b.H., Campus 21, Liebermannstraße A01 404, A- 2345 Brunn/Gebrige. Mattel Italy Srl, Via Bracco, 6-MAC 6, 20159 Milano, Italy. Servizio assistenza clienti: Customersrvitalia@mattel.com - Numero verde 800 11 37 11. Mattel España, S.A., Aribau 200. 08036 Barcelona. c.service.spain@mattel.com Tel: 900 102 390 <http://www.service.mattel.com/es>. Mattel East Asia Ltd., Room 503-09, North Tower, World Finance Centre, Harbour City, Tsimshatsui, HK, China. Tel.: (852) 3185-6500. Dliimport & Diedarkan Oleh: Mattel Continental Asia Sdn Bhd. Level 19, Tower 3, Avenue 7, No. 8 Jalan Kerinchi, Bangsar South, 59200 Kuala Lumpur, Malaysia. Mattel South Africa (PTY) LTD, Office 102 I3, 30 Melrose Boulevard, Johannesburg 2196. Dystributor: Mattel Poland Sp. z o.o., Warsaw Trade Tower 34 p., ul. Chłodna 51, 00-867 Warszawa. Mattel Australia Pty. Ltd., 658 Church St, Richmond, Victoria, 3121. Consumer Advisory Service - 1300 135 312. Mattel AEBE, Εθνάρχου Μακαρίου 1, Κτήριο Κ-2, ΤΚ 17561, Παλιού Φάληρο. Mattel Oyuncakçılık Tic. Ltd. Şti. İçerenköy Mah., Erkut Sok. A Blok No:12 Üner Plaza Kat:9-10 34752 Ataşehir İstanbul. Tel: 0216 570 75 00. Импортер/Полномоченная организация: ООО "МАТТЕЛ" Российская Федерация, 105120 Москва, 2-й Сыромятинский переулок, 1; +7 495 287 79 39. Mattel Czech Republic s.r.o., The Forum, Václavské nám. 19, 11000 Praha1. Mattel, 333 Continental Boulevard, El Segundo, CA 90245, USA. Consumer Services: 1-800-465-MEGA (6342). Mattel Canada Inc., Mississauga, Ontario L5R 3W2. Consumer Services: You may call us free at/ Composez sans frais le 1-800-524-8697. Importado y distribuido por Mattel de México, S.A. de C.V., Miguel de Cervantes Saavedra No. 193, Pisos 10 y 11, Col. Granada, Alcaldía Miguel Hidalgo, C.P. 11520, México, Ciudad de México. R.F.C. MME-920701-NB3. Tels.: 59-05-51-00 Ext. 5206 6 01-800-463-59-89. Mattel Chile, S.A., Avenida América Vespucio 501-B, Quilicura, Santiago. Tel.: 1230-020-6213. Servicio al consumidor Venezuela: Tel.: 0-800-100-9123. Mattel Argentina, S.A., Av. Libertador 1000, Piso 11 - Oficinas 109 y 111, Vicente López - Prov. Buenos Aires. Tel.: 0800-666-3373. Mattel Colombia, S.A., Calle 123#7-07 P.5, Bogotá. Tel.: 01800-710-2069. Mattel Perú, S.A., Av. Juan de Arona # 151, Centro Empresarial Juan de Arona, Torre C, Piso 7, Oficina 704, San Isidro, Lima 27, Perú. RUC: 20425853865. Reg. Importador: 02350-12-JUE-DIGESA. Tel.: 0800-54744. E-mail Latinoamérica: service.clients@mattel.com. Mattel do Brasil Ltda.- CNPJ : 54.558.002/0001-20 - Rua Verbo Divino, 1488 - 2º. Andar - 04719-904 - Chácara Santo Antônio - São Paulo - SP - Brasil. Serviço de Atendimento ao Consumidor: fone 0800 575 0780. E-mail: sac.matteldobrazil@mattel.com



POKÉMON



GMD31



HDL84

Set(s) sold separately and subject to availability. / Ensemble(s) vendu(s) séparément. Certains produits peuvent ne pas être commercialisés. / Se vende(n) por separado y está(n) sujeto(s) a disponibilidad. / Conjunto(s) vendido(s) em separado e sujeito(s) a disponibilidade. / Set in vendita separatamente, secondo disponibilità. / Das/Die Set(s) sind separat erhältlich. / Zestaw(y) sprzedawany(e) oddzielnie w zależności od dostępności. / Set(s) apart verkrijgbaar en afhankelijk van beschikbaarheid. / Набор(ы) продаются отдельно, при наличии. / Sæt sælges separat og så længe lager rækker. / Seten säljs separat så länge lagret räcker. / Settett/settene selges separat så langt lageret rekker. / Pakkaus/pakkaukset myydään erikseen, saatavuus voi vaihdella. / Το(α) σετ πωλούνται ξεχωριστά και ανάλογα με τη διαθεσιμότητα. / Setler ayrı olarak satılır ve stoklarla sınırlıdır. / Set (sety) se prodává (prodávají) samostatně dle aktuální nabídky. / Súprava/-y sa predáva(jú) samostatne a podľa dostupnosti. / A készlet(ek) külön kapható(k), az elérhetőség változhat. /

セット商品は別売りになります。在庫状況は別途ご確認お願いします。 /

تباع المجموعة أو المجموعات على حدة وتخضع لتوافرها.

每套单独发售，按供货情况决定。

Mattel Canada Inc. Mississauga, Ontario L5R 3W2.
MADE IN CHINA. FABRIQUÉ EN CHINE. FABRICADO NA / HECHO EN CHINA.
ИЗГОТОВЛЕНО В КИТАЕ. ÇIN'DE ÜRETİLMİŞTİR. صنع في الصين

© D781,964, D797,203, D834,105

1186 MJ, 1, NL

©2022 MEGA Brands® &™ MEGA Brands.
Printed in China / Imprimé en Chine

AD-GYH06-05

