

MEGA  
CONSTRUX

# HALO



HALO  
UNIVERSE

HDP62

UNSC Falcon Sweep • L'attaque du UNSC Falcon  
UNSC Falcon de búsqueda • Ofensiva do UNSC Falcon  
Falcon UNSC da incursione



# Build Construisez

Construye  
Constrói  
Bauen  
Стройте



# Share Partagez

Comparte | Partilha  
Teilen | Делитесь

Devices not included | Aparelhos não incluídos | Dispositivos no incluido  
Dispositivos não incluídos | Geräte nicht enthalten | Устройства не входят в комплект



Show off your  
custom creations!

Montrez vos créations !

¡Exhibe tus creaciones personalizadas!  
Exibe as tuas criações personalizadas!  
Für coole Eigenkreationen!  
Покажите свои собственные творения!



unboxed.megaconstrux.com



1

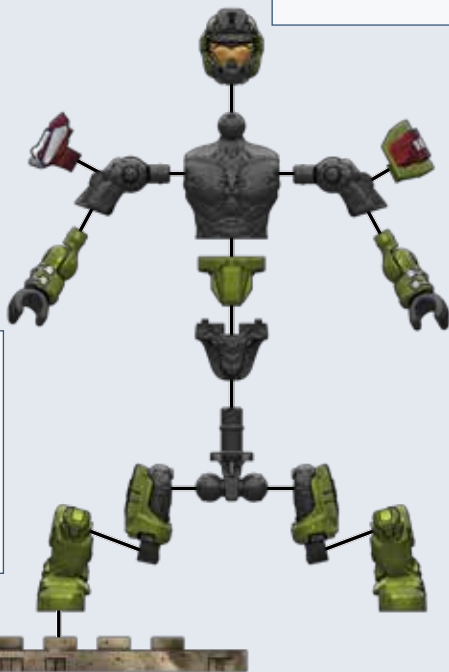



**Building Tool**  
**Outil de construction**

Herramienta de construcción  
Bauwerkzeug  
Ferramenta de montagem  
Инструмент для конструирования

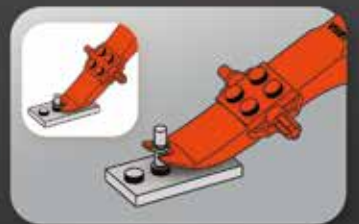
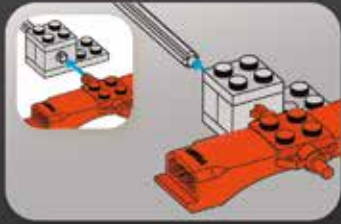

2



2X



1X

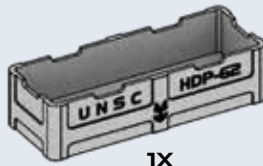

1X



1



2



3

3



1X



1X

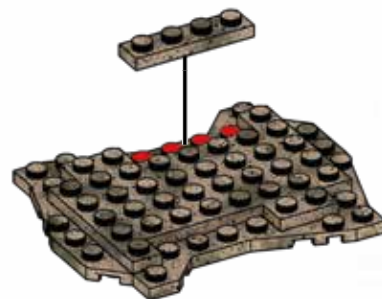

4



3X

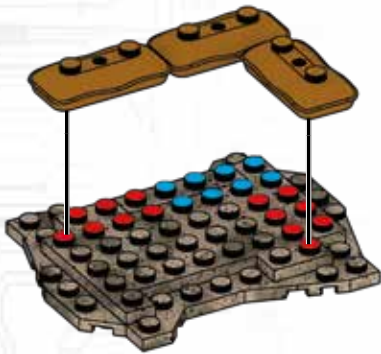

5



3X

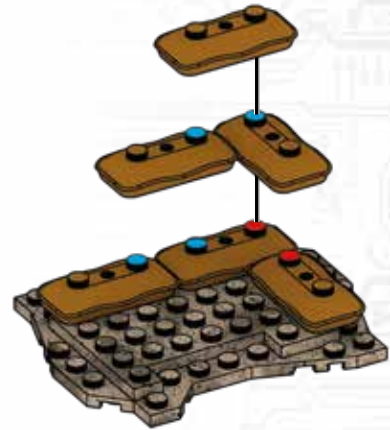

6



2X



1X



1X



1



2



3



1



2



7



2X



1X

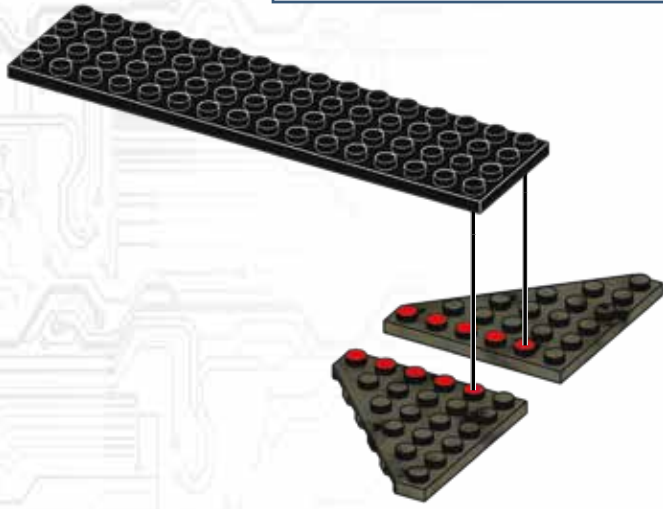

1



2

8



2X



1X

9



1X



1X



1X



1X

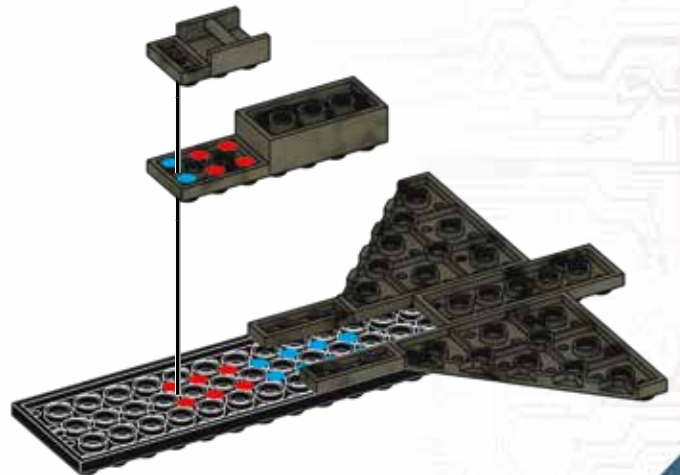
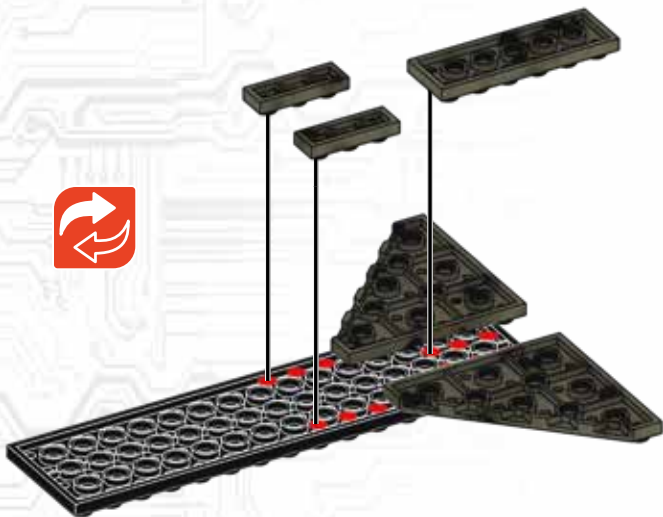

10

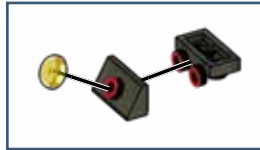

Place temporary piece.  
 Placer la pièce temporaire.  
 Colocar la pieza provisional.  
 Colocar a peça temporária.  
 Posizionare il pezzo provvisorio.  
 Das vorübergehend benötigte Teil platzieren.  
 Umieścić tymczasowy element.  
 Plaats tijdelijk deel.  
 Поместите временную деталь.  
 Placer midlertidigt stykke.  
 Placera temporär del.  
 Plasser midlertidig del.  
 Aseta väliaikainen osa.  
 Τοποθετήστε το προσωρινό κομμάτι.  
 Geçici parçayı yerleştirin.  
 Umístěte dočasný díl.  
 Vložte dočasný kus.  
 Helyezze el az ideiglenes darabot.  
 暫定ピースを配置してください  
 ضع القطعة المؤقتة.

放置临时件



11



12

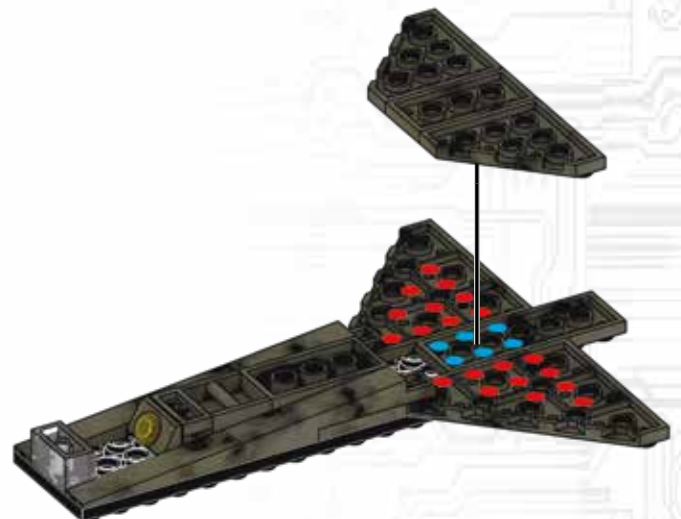

13



2x

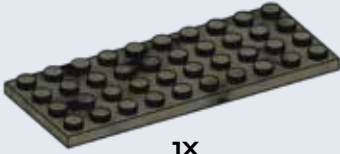

1x

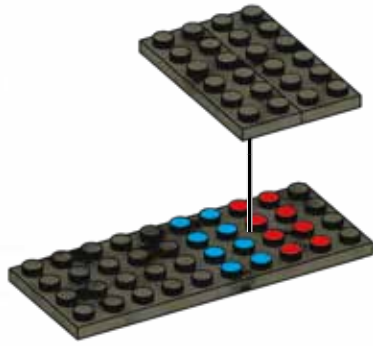

1



2

14

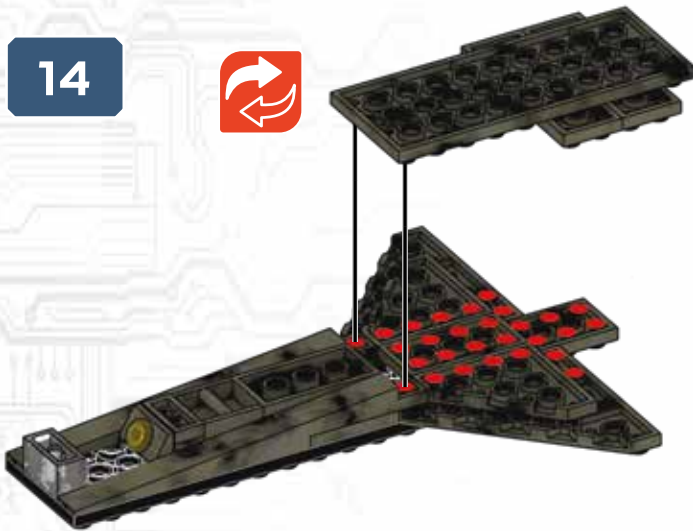

1



2

15



2x

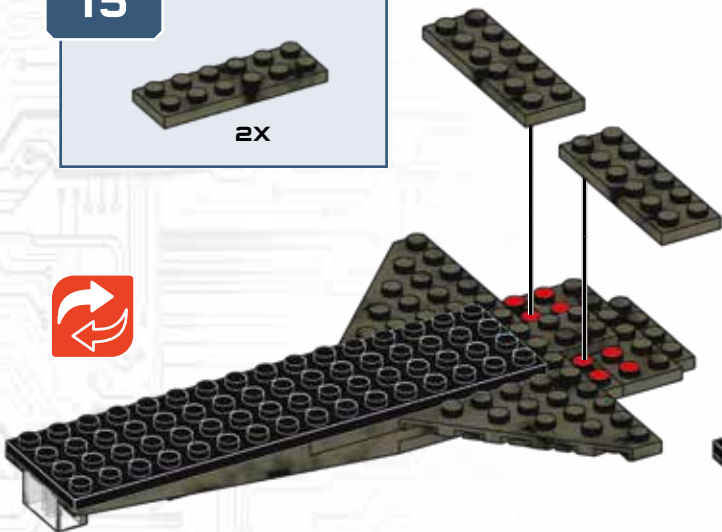

1



2

16

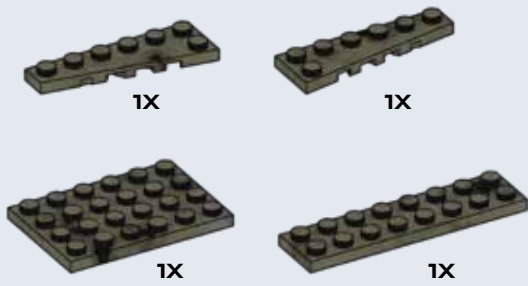

1X

1X

1X

1X



17

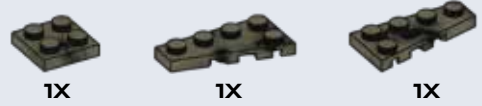

1X

1X

1X



18



2X



Place temporary pieces.  
 Placer les pièces temporaires.  
 Colocar las piezas provisionales.  
 Colocar as peças temporárias.  
 Posizionare i pezzi provvisori.  
 Die vorübergehend benötigten Teile platzieren.  
 Umieść tymczasowe elementy.  
 Plaats tijdelijke delen.  
 Поместите временные детали.  
 Placer midlertidige stykker.  
 Placera temporära delar.  
 Plasser midlertidige deler.  
 Aseta väliaikaiset osat.  
 Τοποθετήστε το προσωρινό κομμάτι.  
 Geçici parçaları yerleştirin.  
 Umístěte dočasné díly.  
 Vložte dočasné kusy.  
 Helyezze el az ideiglenes darabokat.  
 暫定ピースを配置してください  
 صنع القطع المؤقت.

放置临时件

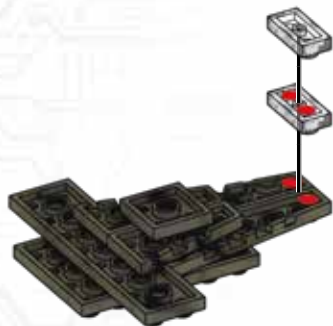

1



2



3



19

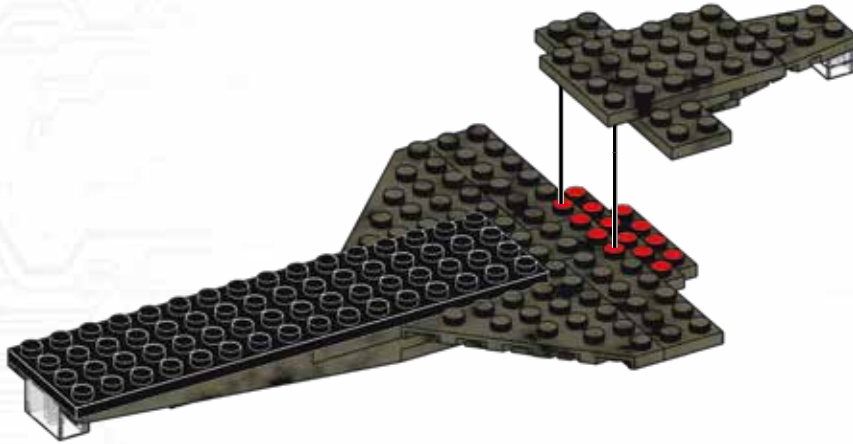

20



2x



2x

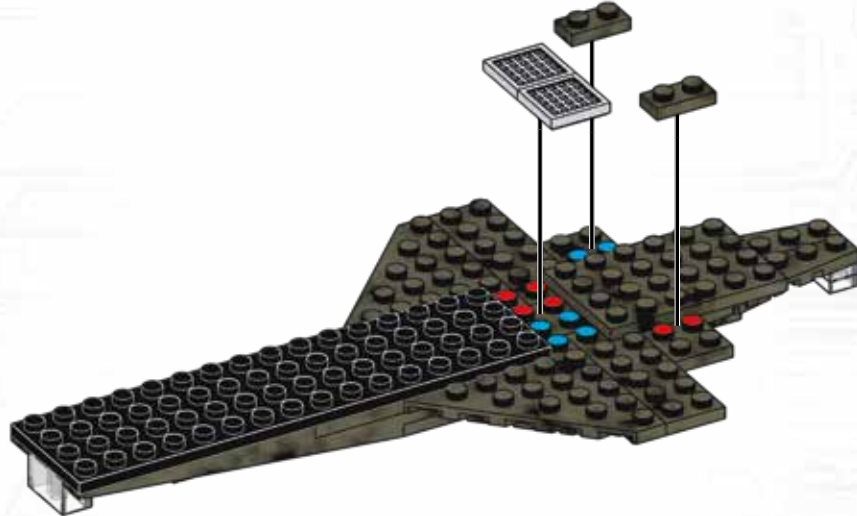

21



6x

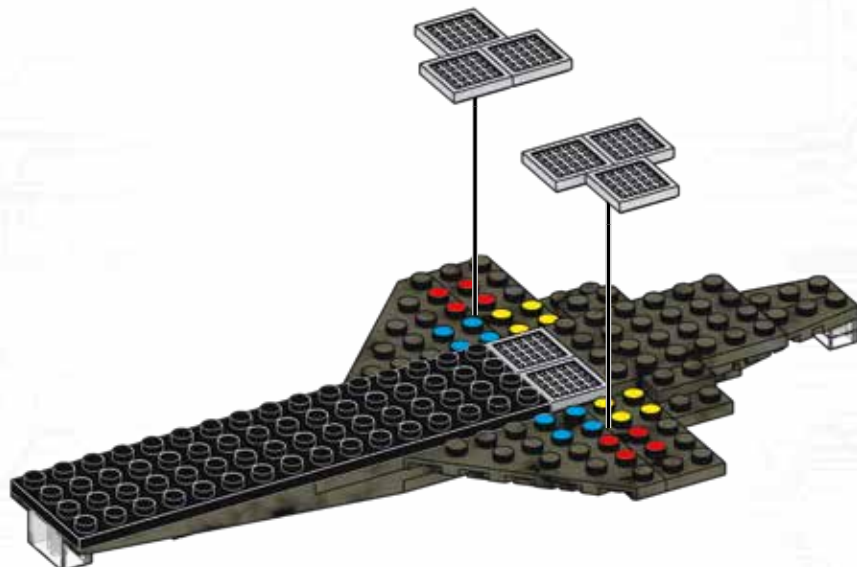

22



8X

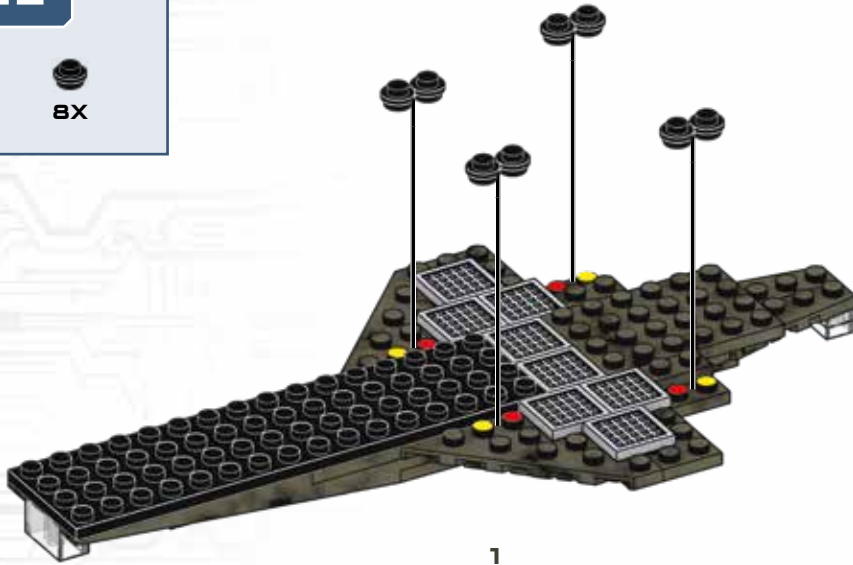

1

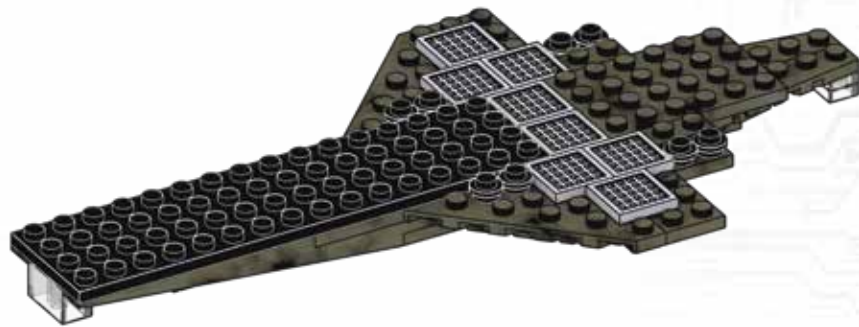

2

23



1X



1X



1X



1X



24



1X



2X



1X

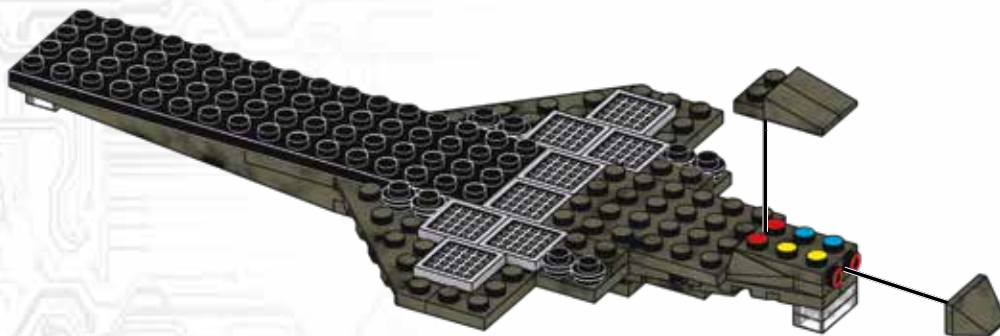

1

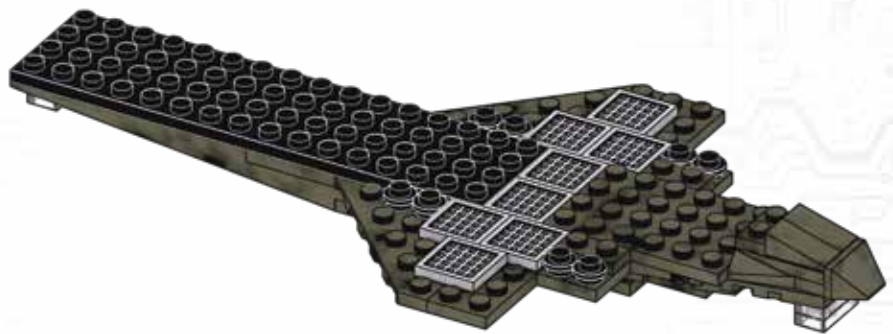

2

25



2X



2X



2X



1X



26



1X



5X

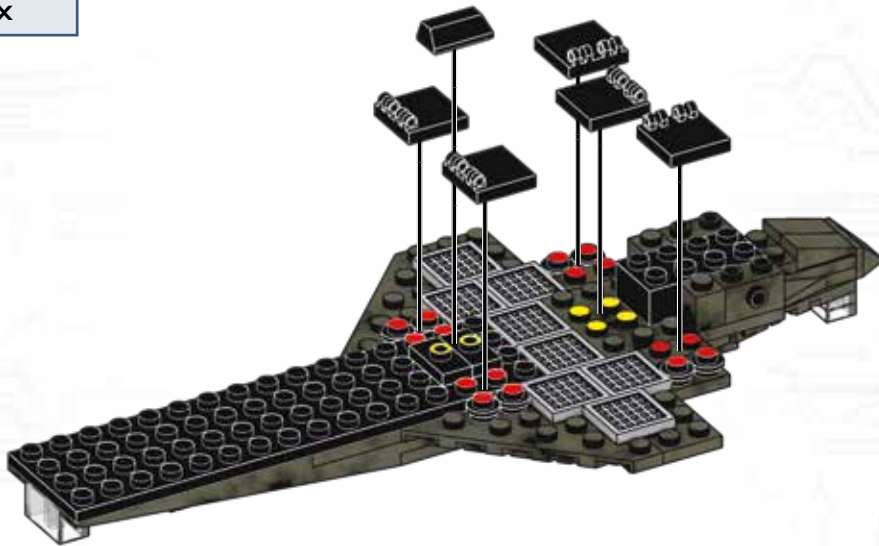

27



1X



2X



1X



28

- 1X [1x 2-hole dark grey Technic brick]
- 2X [2x 2-hole dark grey Technic brick]
- 2X [2x 3-hole dark grey Technic brick]
- 2X [2x 4-hole dark grey Technic brick]

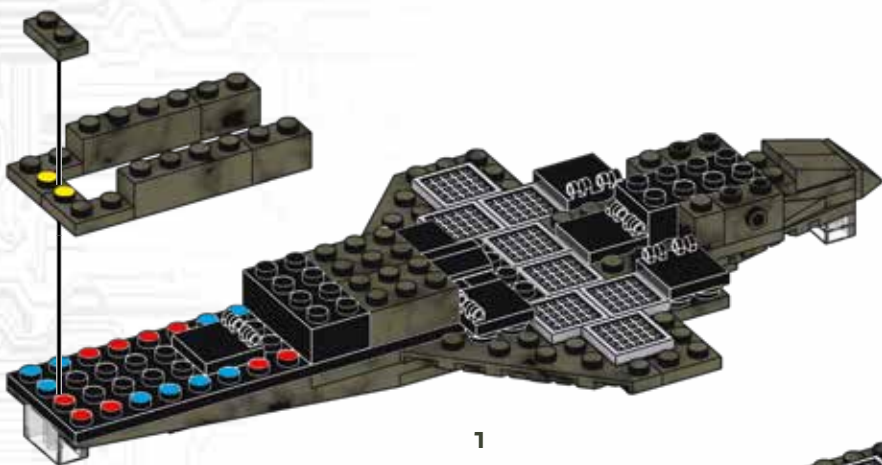

1

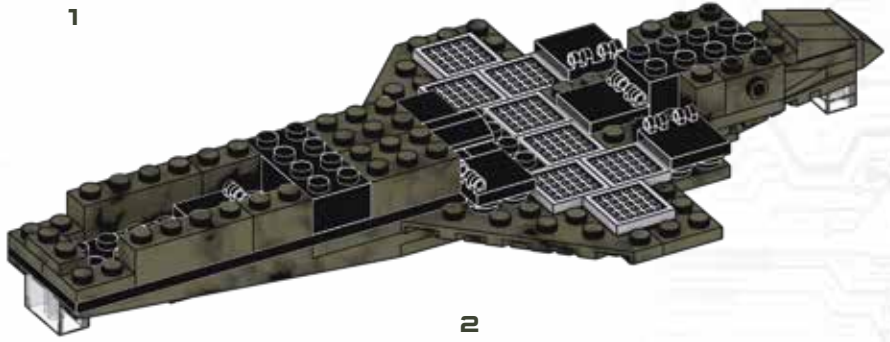

2



29

- 1X [1x black Technic axle]
- 1X [1x black Technic bush]
- 1X [1x dark grey Technic axle connector]



1



2



3

30



31



1



2

32



33

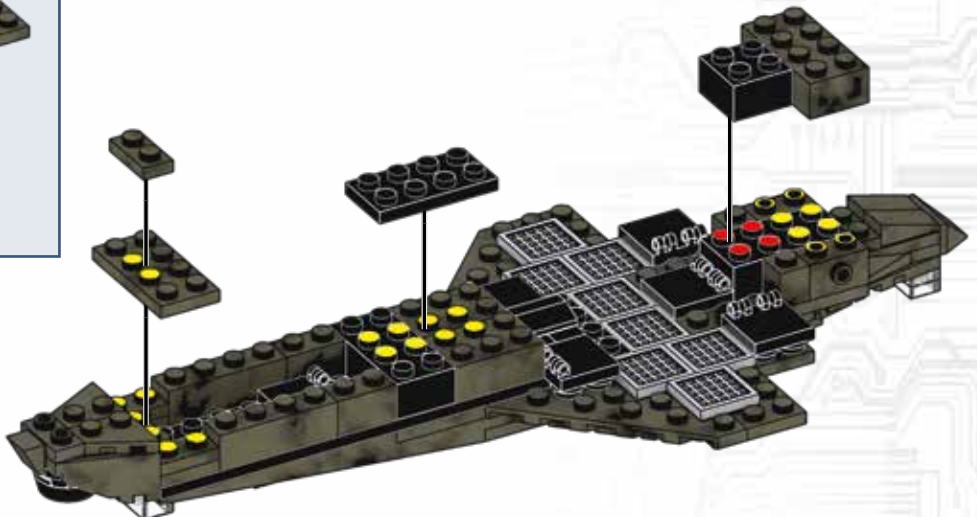
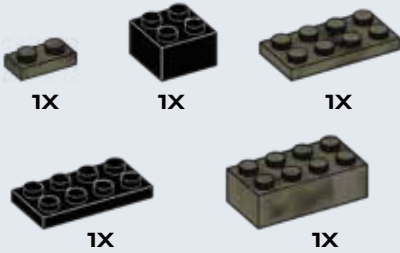

34



2X



10X



2X

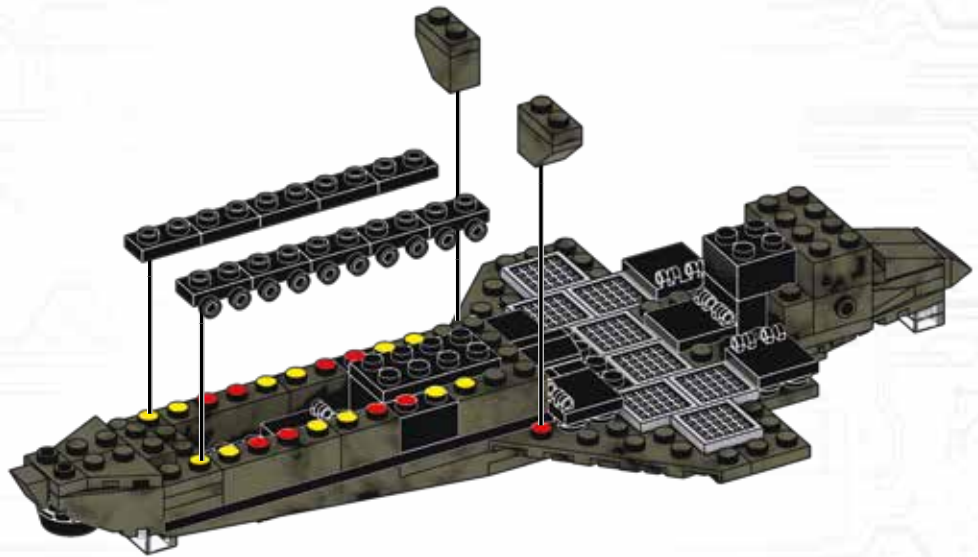
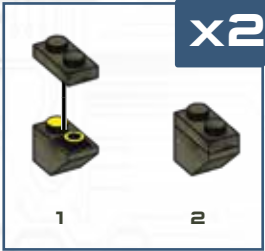

35



2X



2X



1X



1X

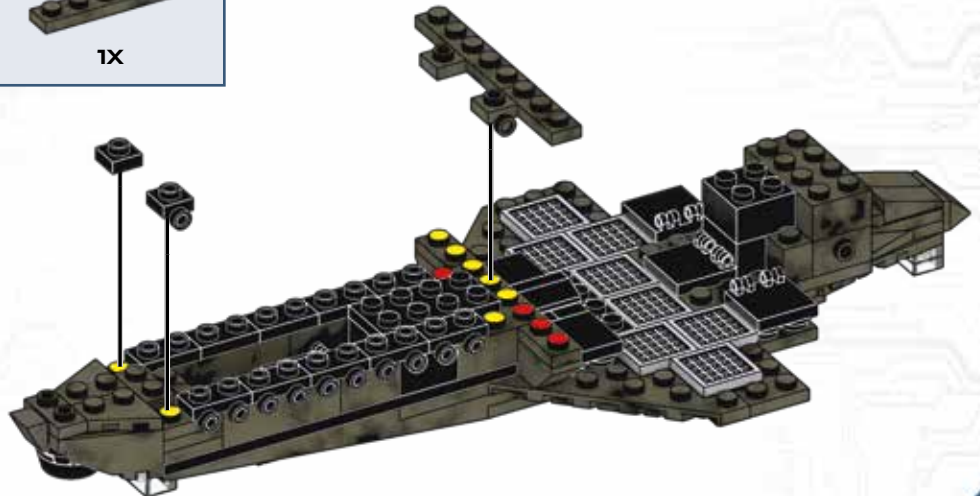

36



2X



2X

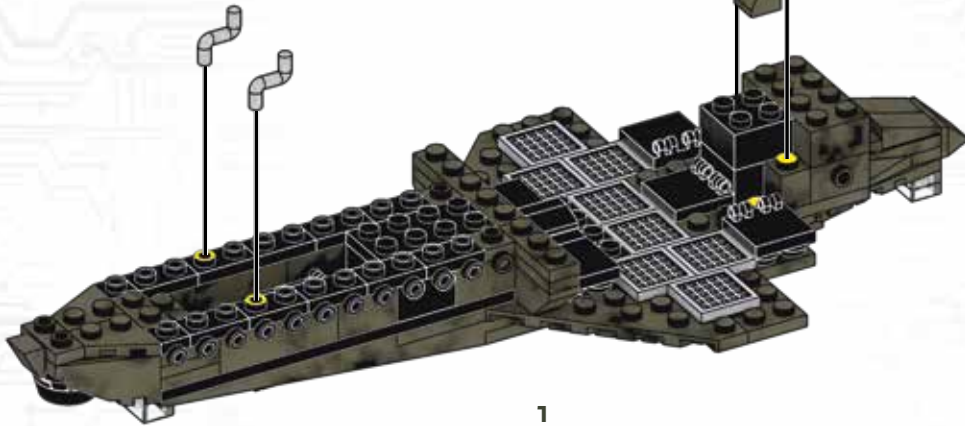

1



2

37



1X



1X



1X



3X



1



2





38



1X



1X

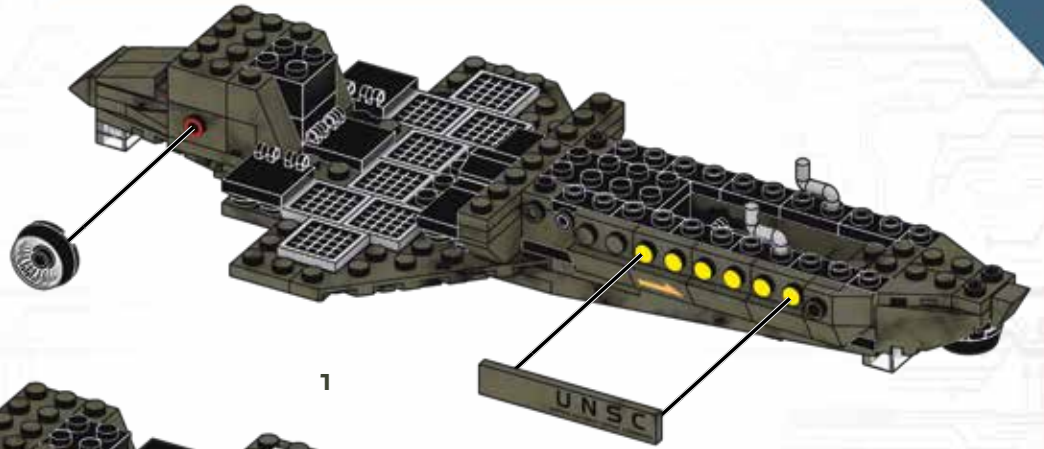

1



2

39



1X



1X



1X



3X

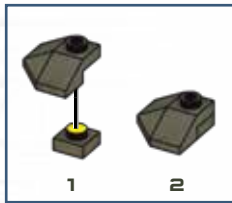

1

2

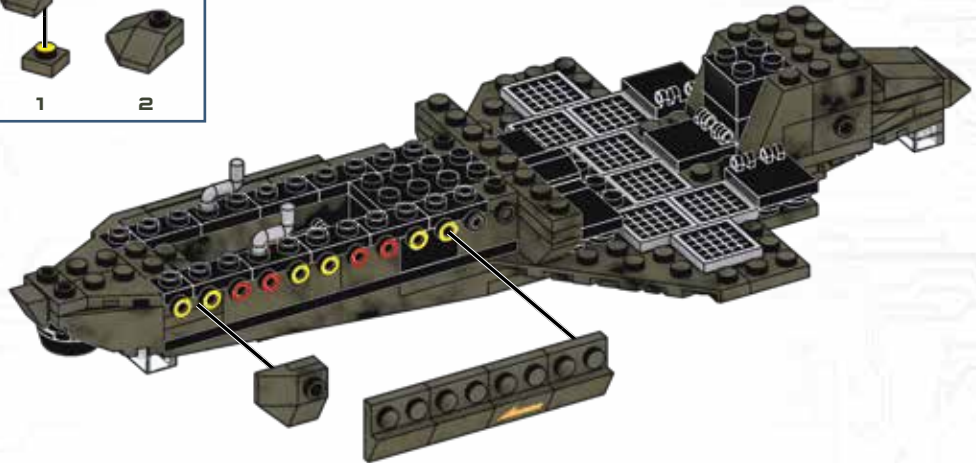

40



1X



1X



# 41

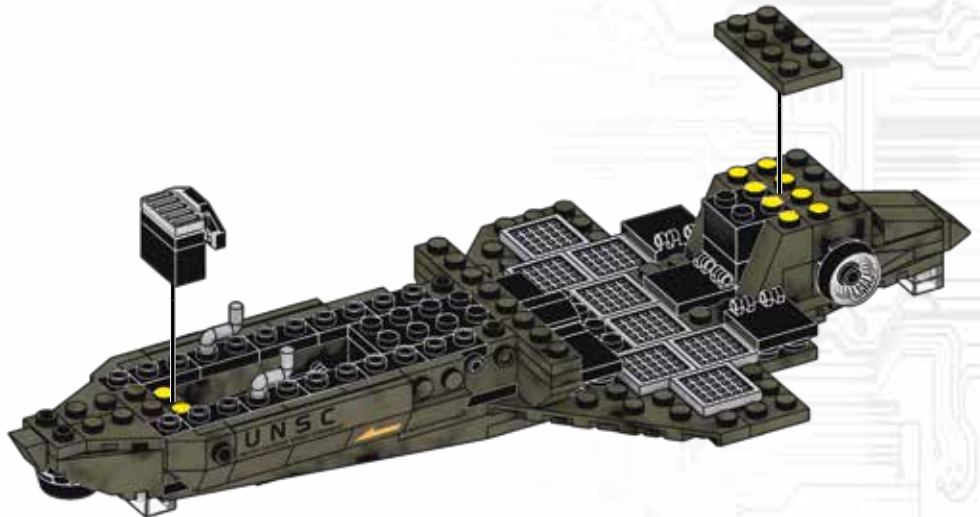
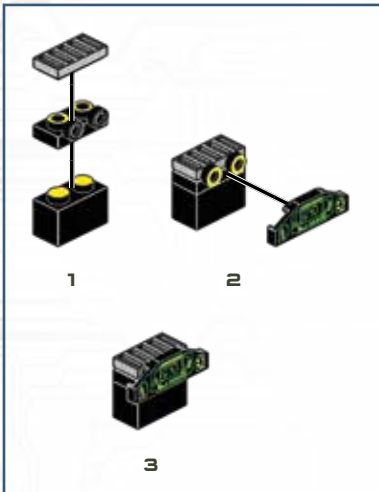

# 42

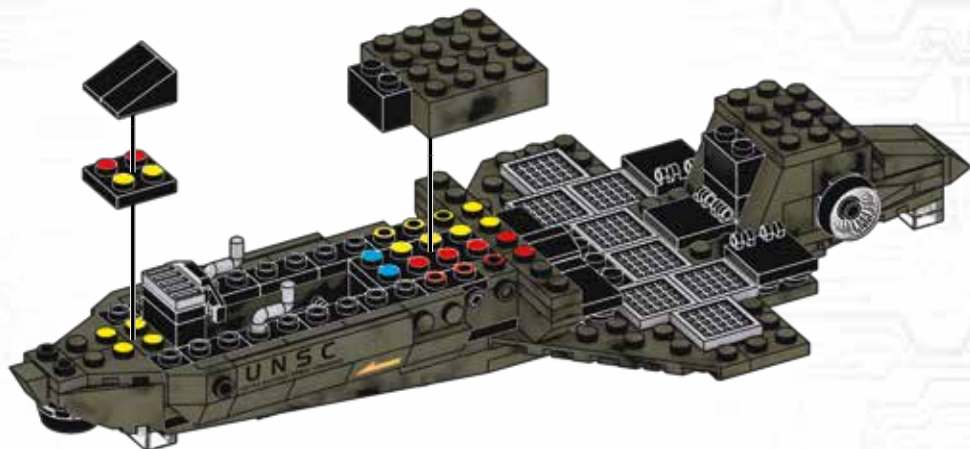

43

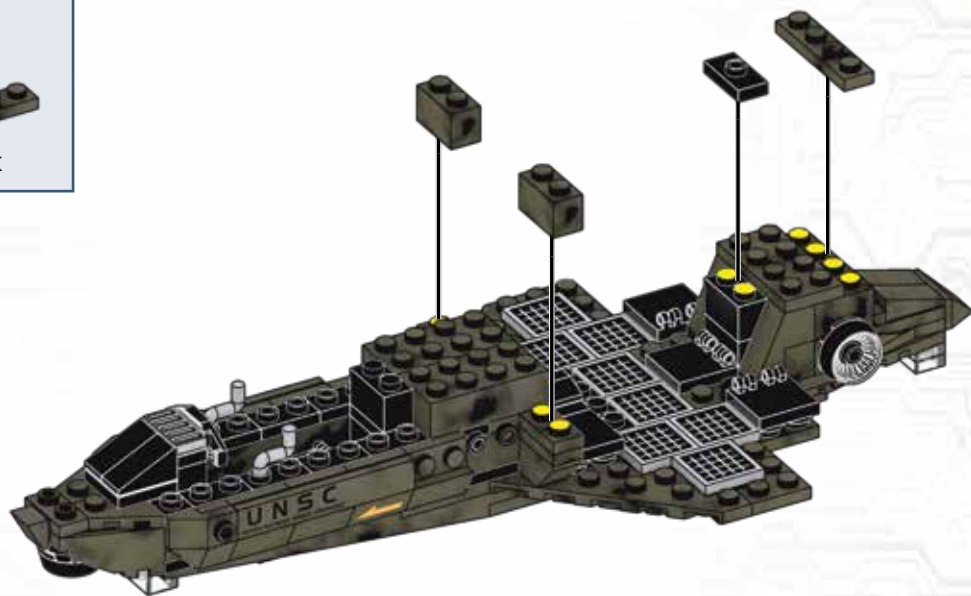

44

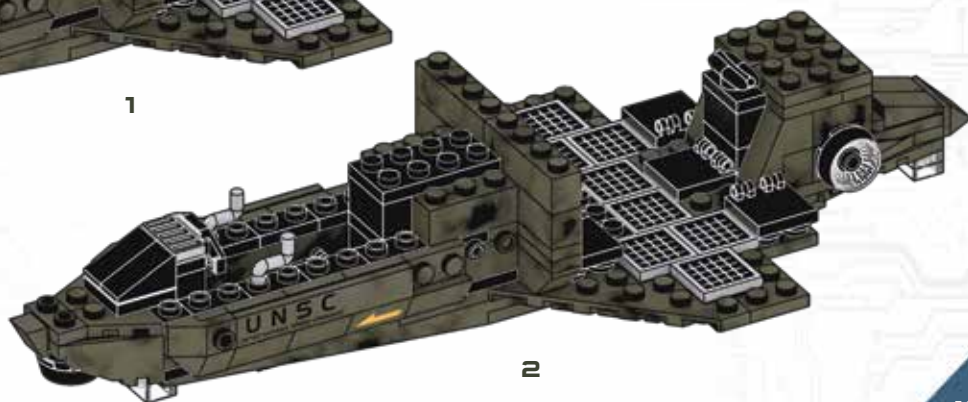
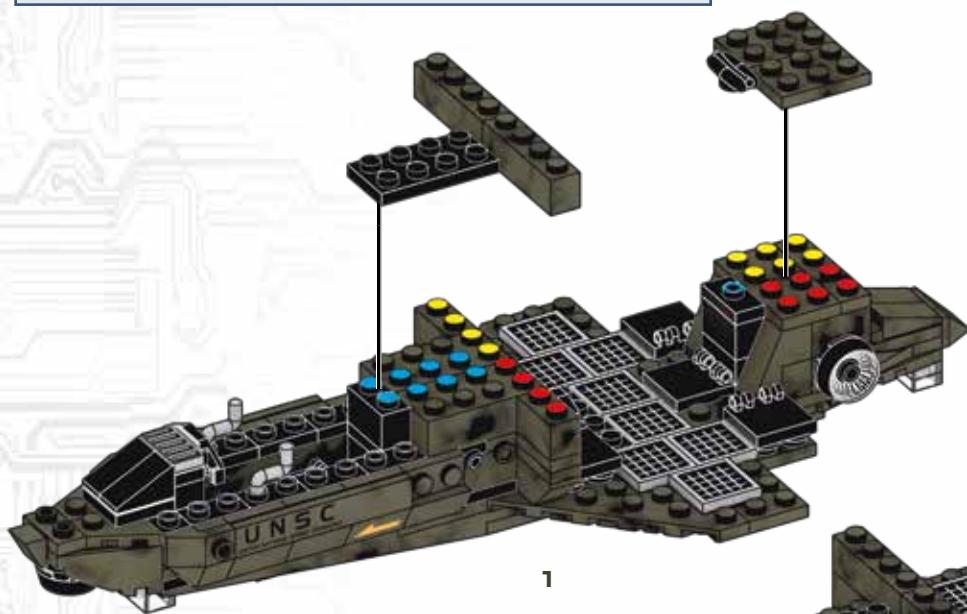



45



1X

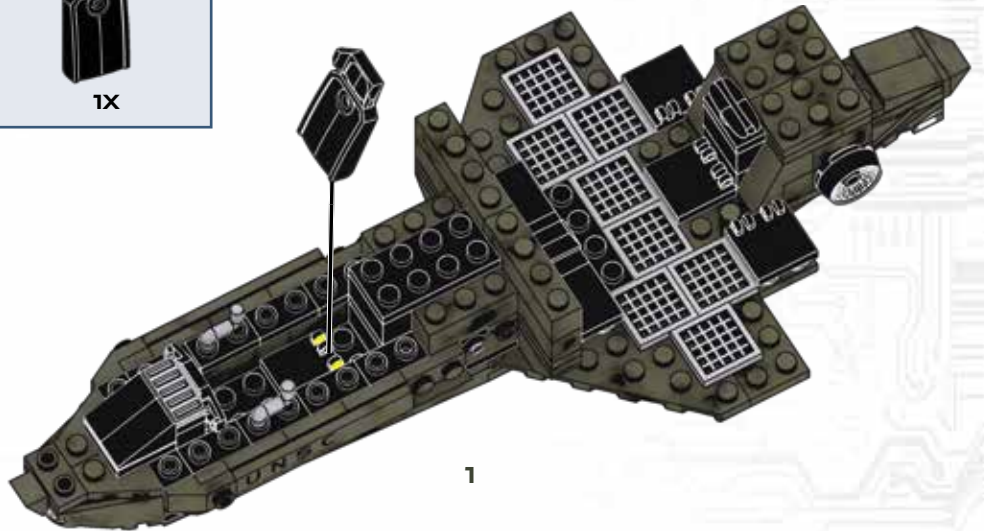

1

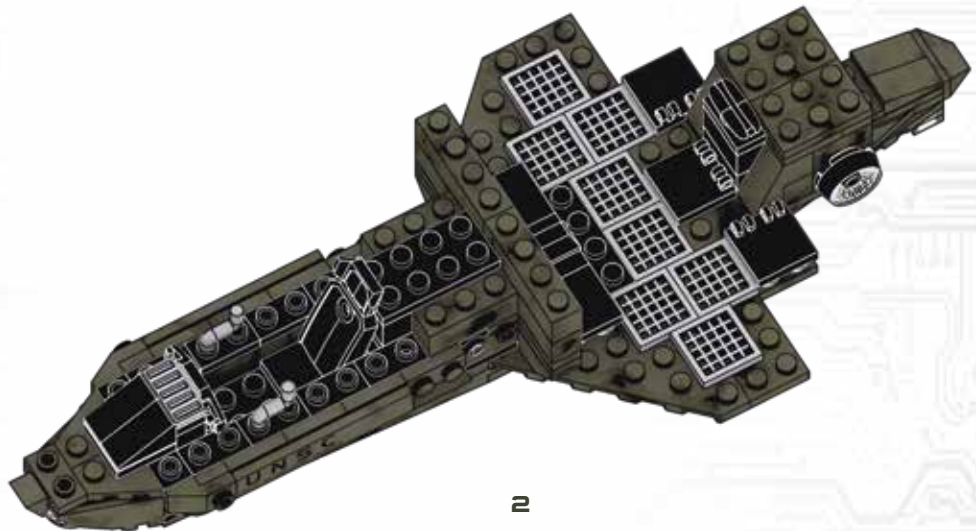

2

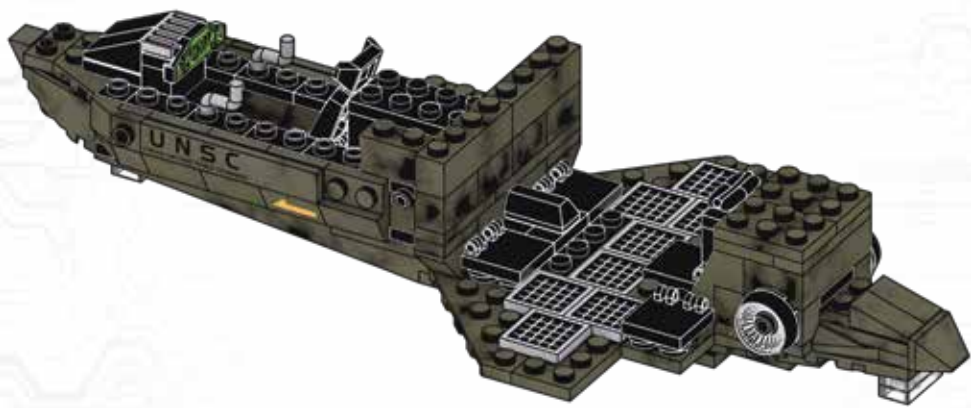

3

46

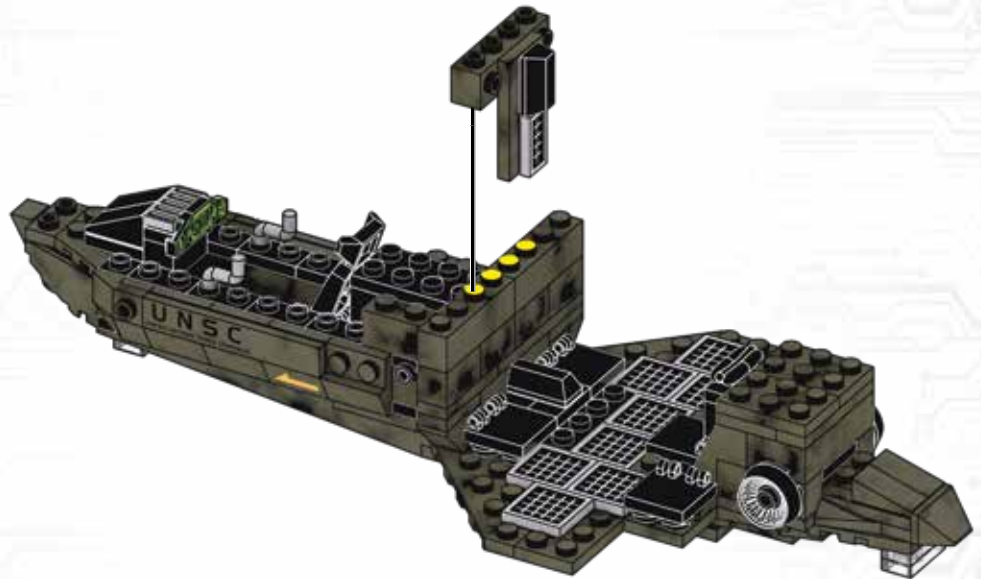
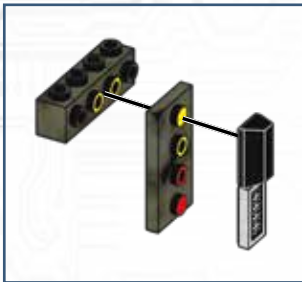

47

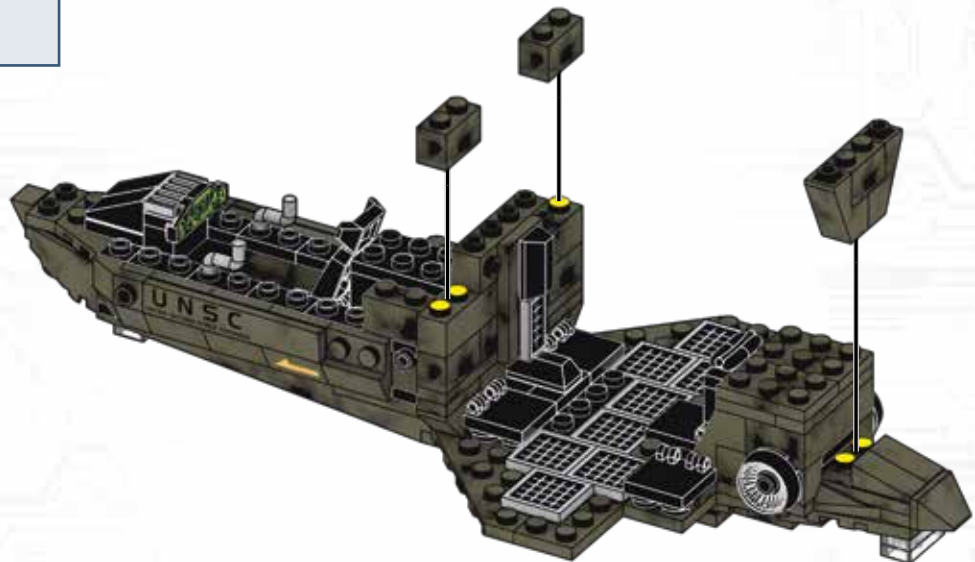
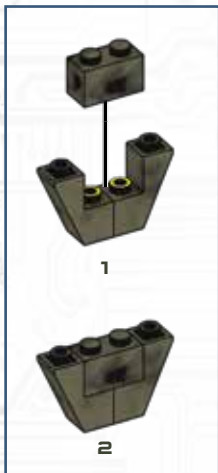

48



1X



1X



2X

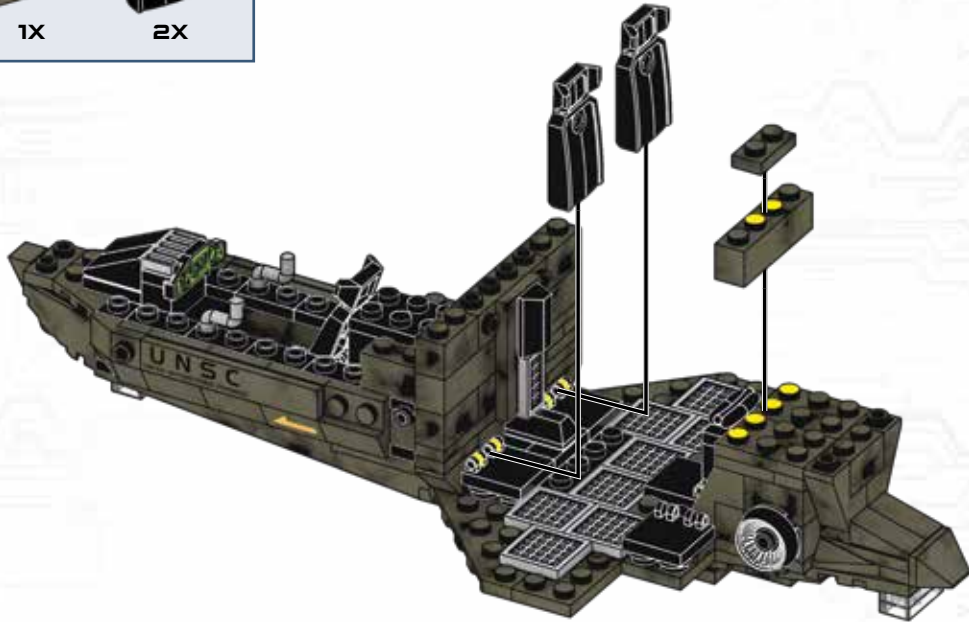

1

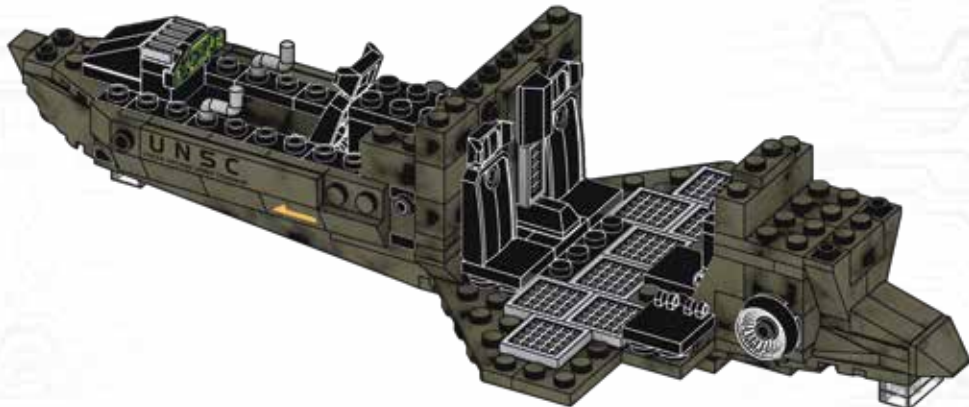

2

49



3X

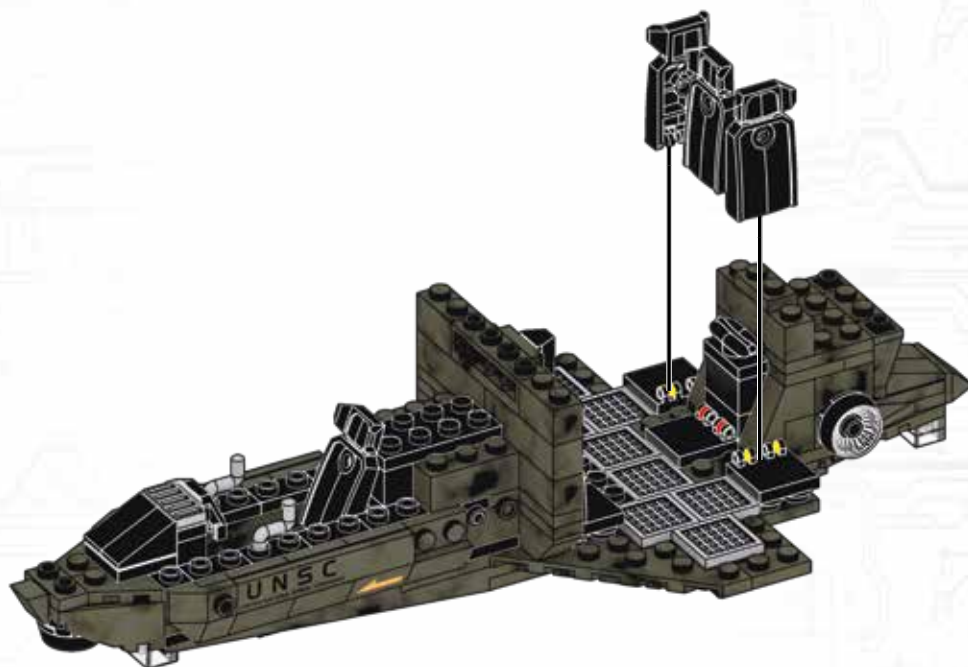

50



2X



2X



1X



1X

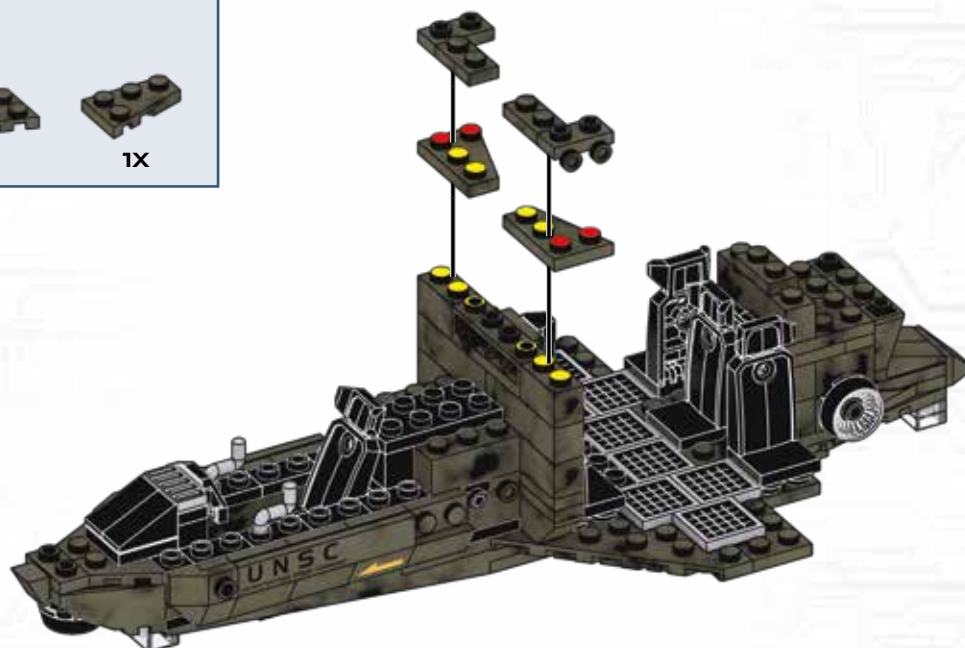

51

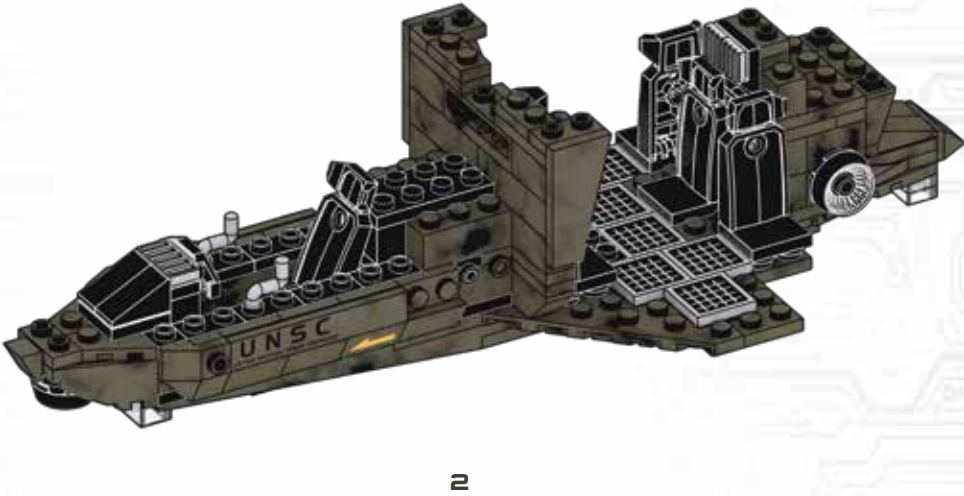
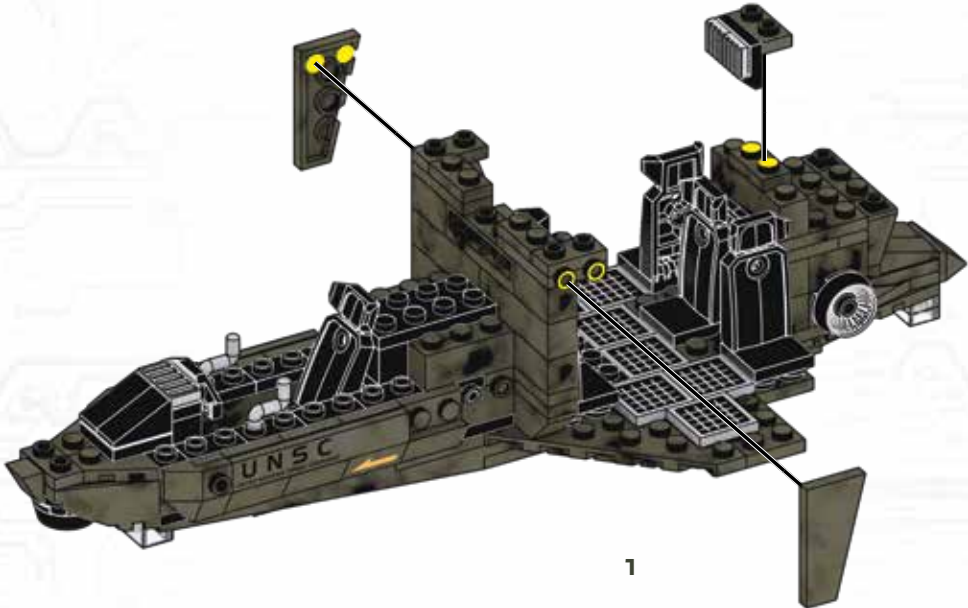
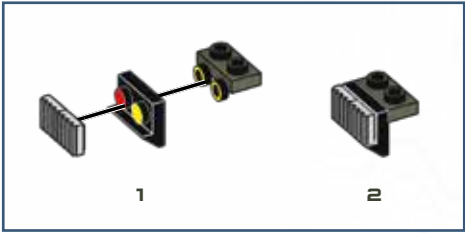





5X



1X



1X



1X



1X



1X

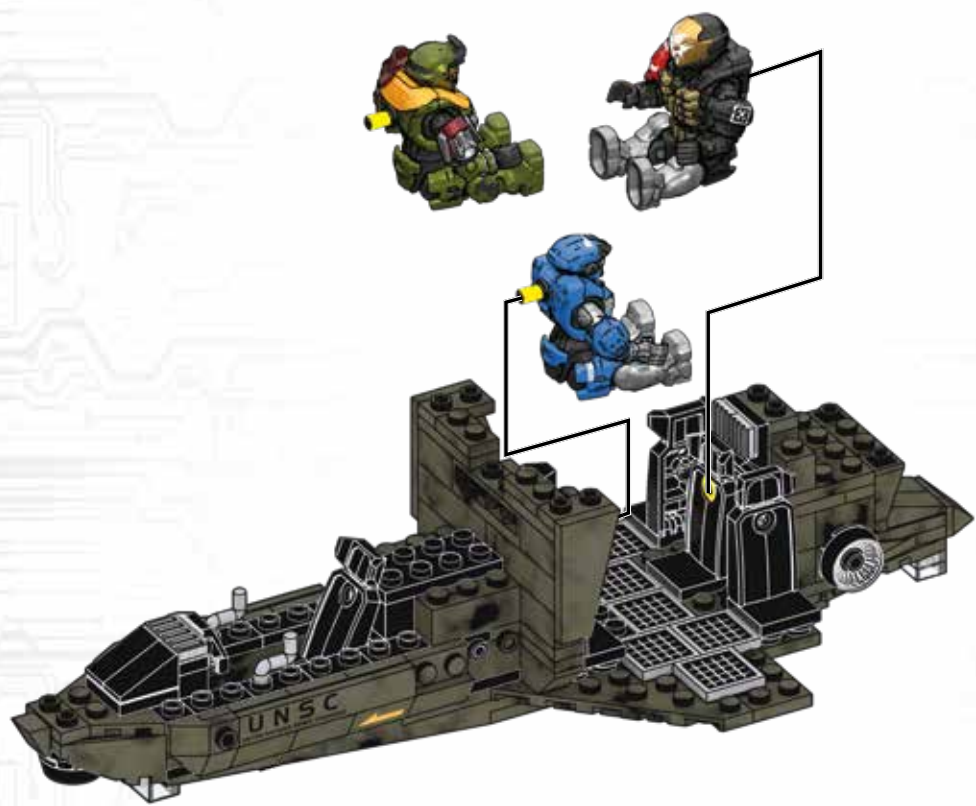
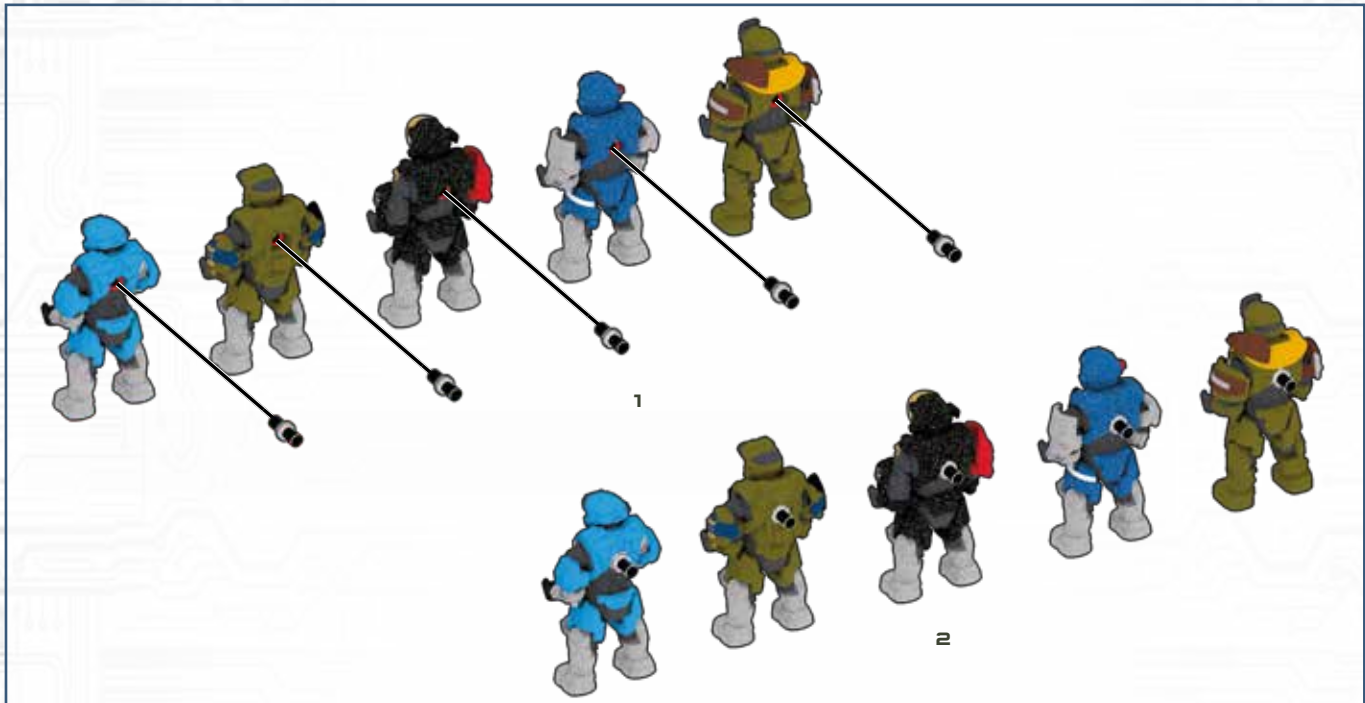

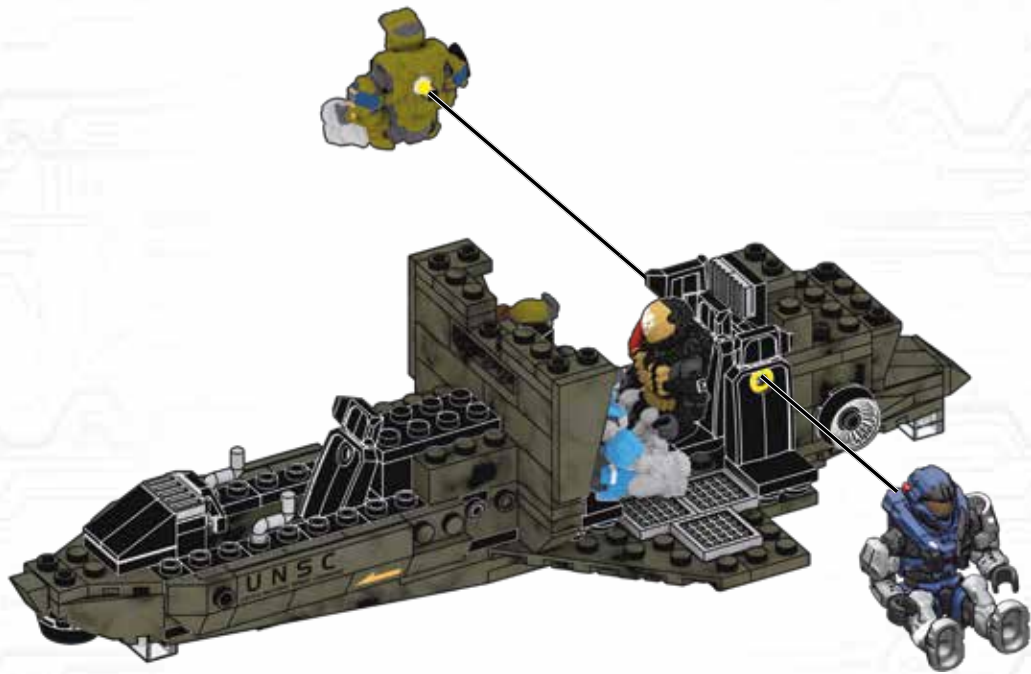

1



2

54

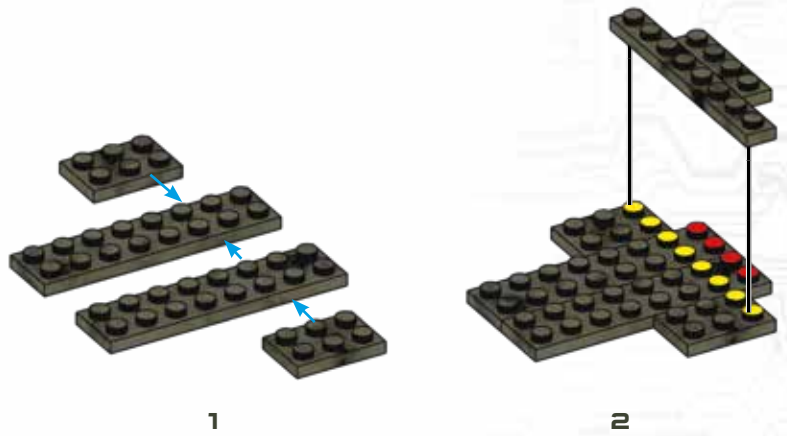
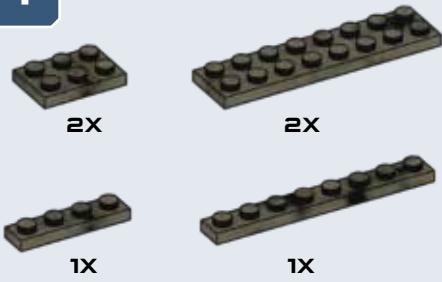

55

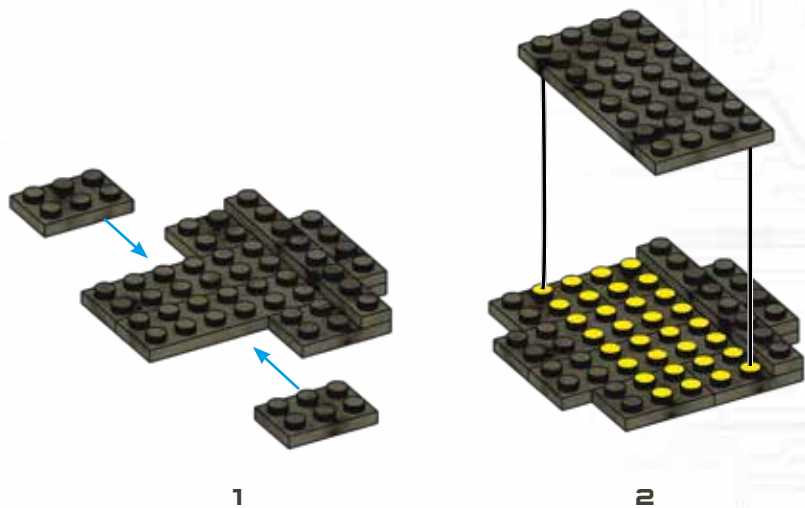
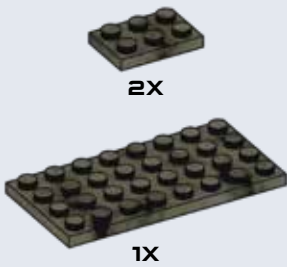

56

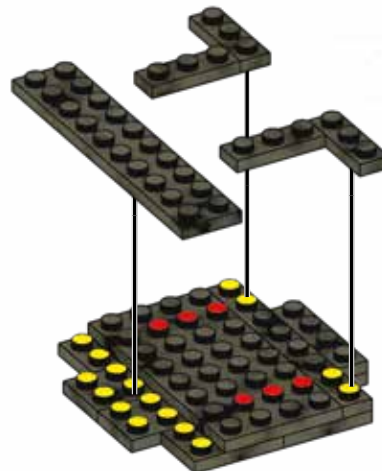

57



1X



2X

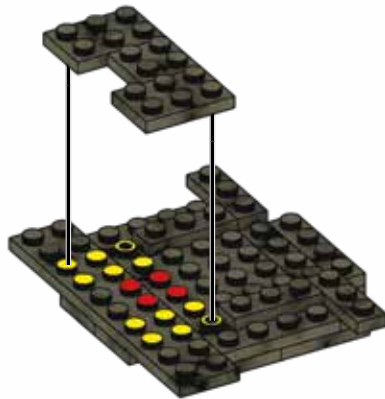

58



2X



4X

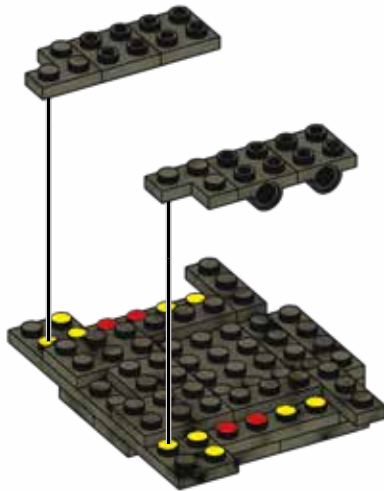

1



2

59

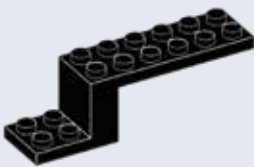

2X

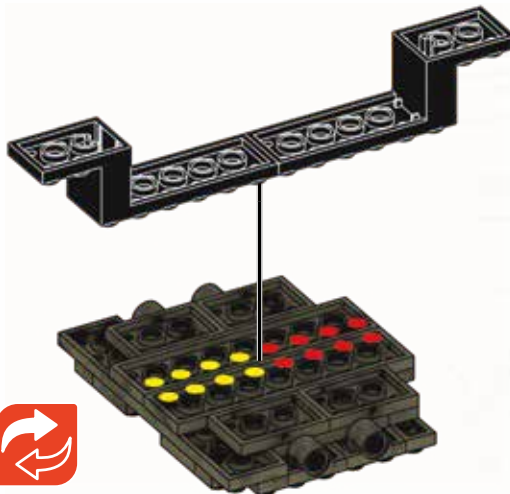

60



2X

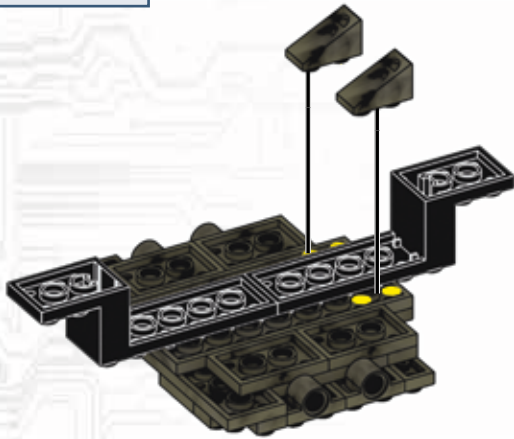

1



2

61



62



4X

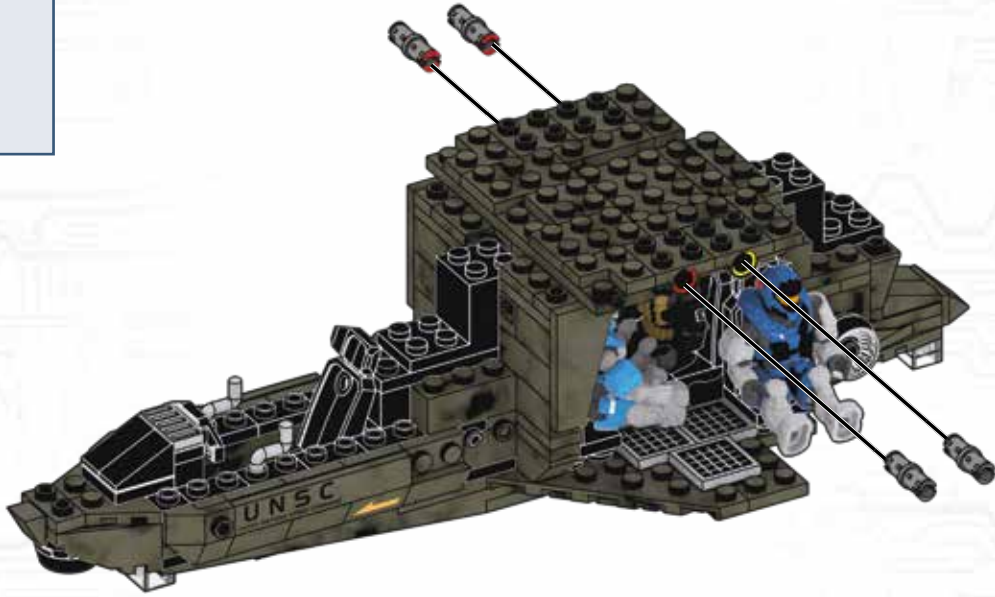

63



2X



1X

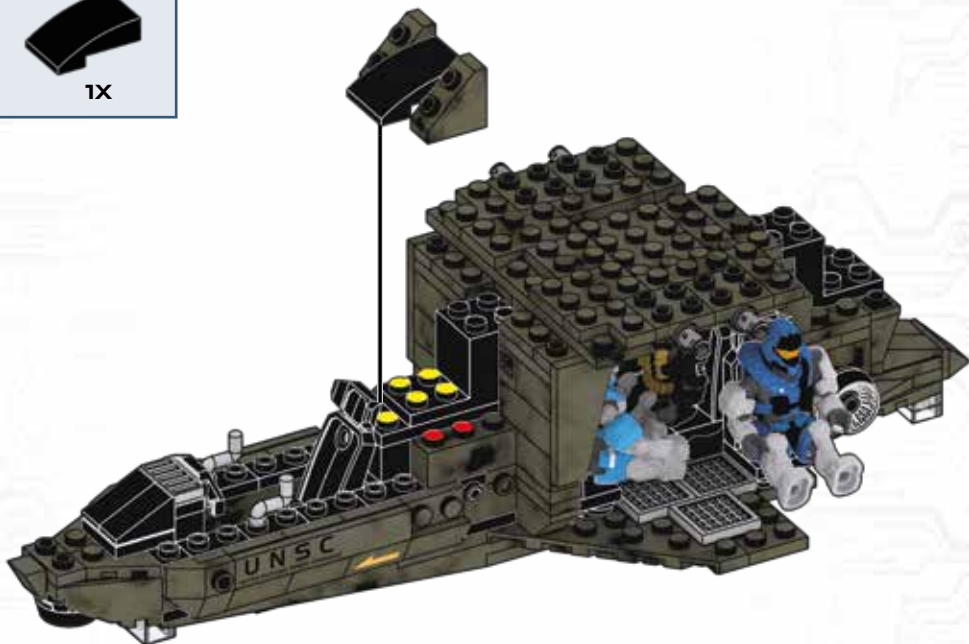

64



2X



2X



65



1X



1X



1X



66



6X



2X

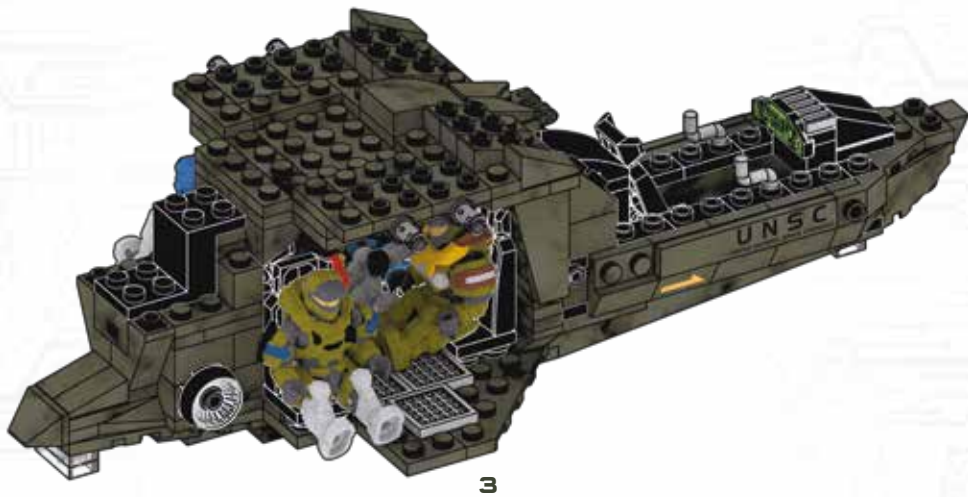
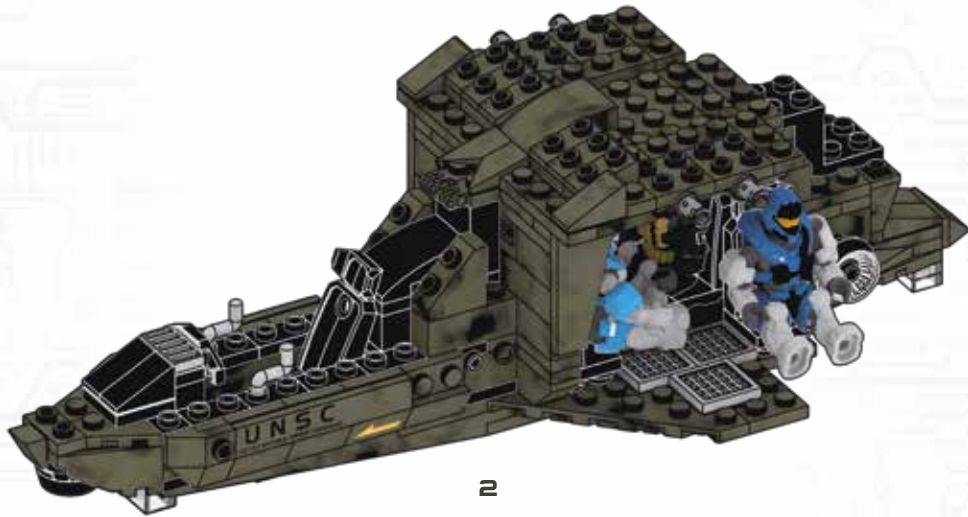





67

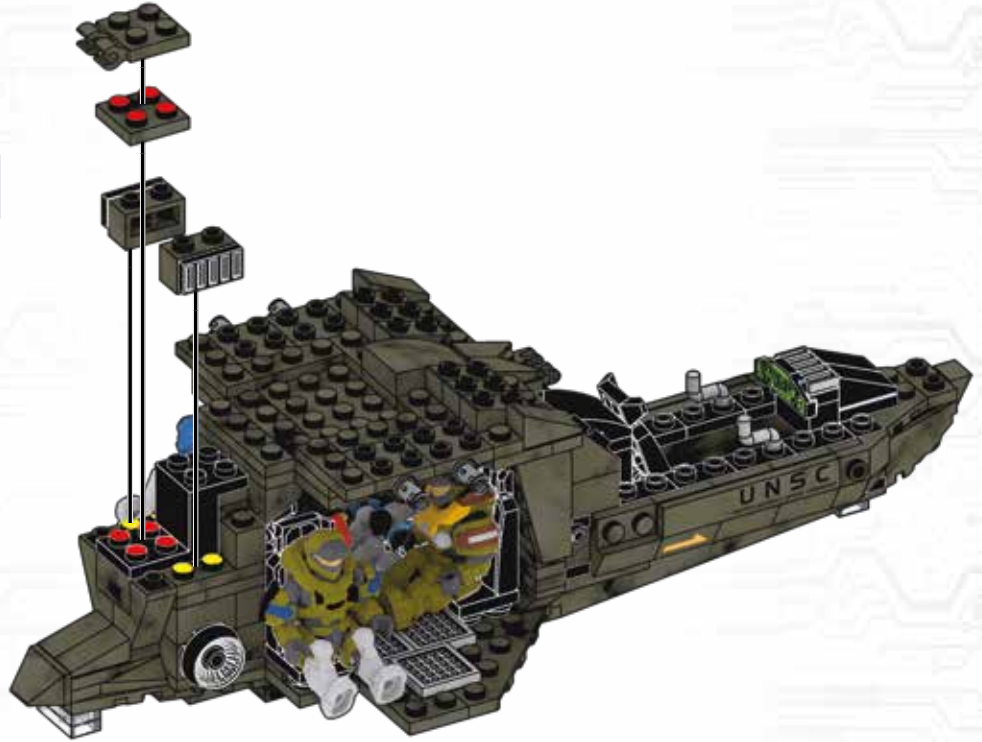
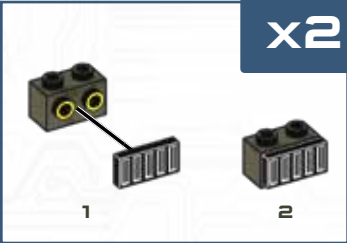

68



69



70

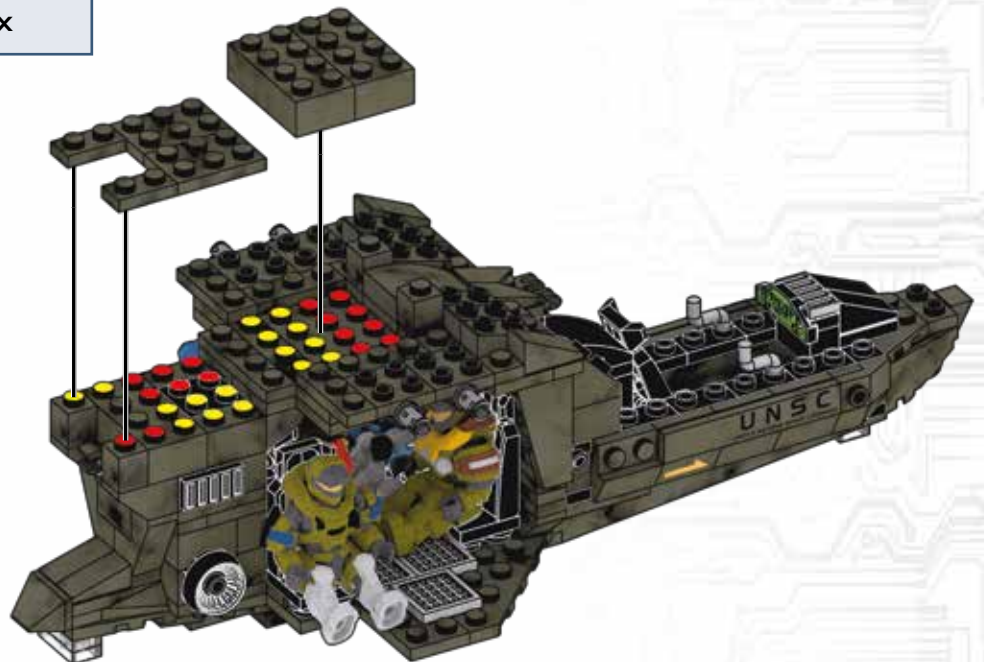

71



2X

1X



2X



2X

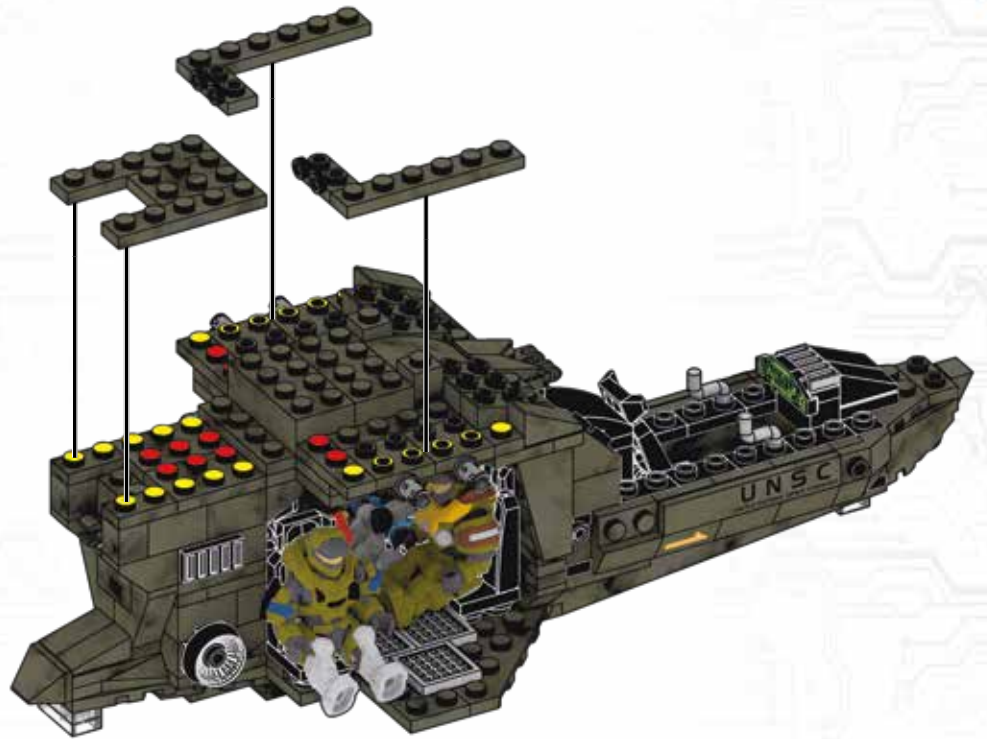

72



2X



2X

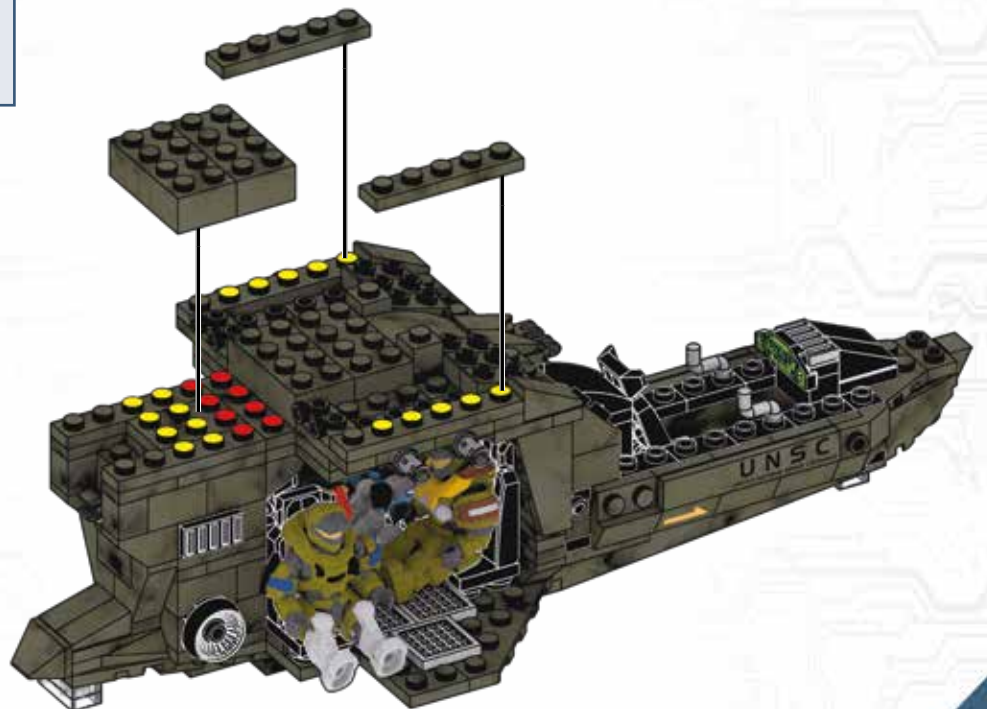

73



2X



2X

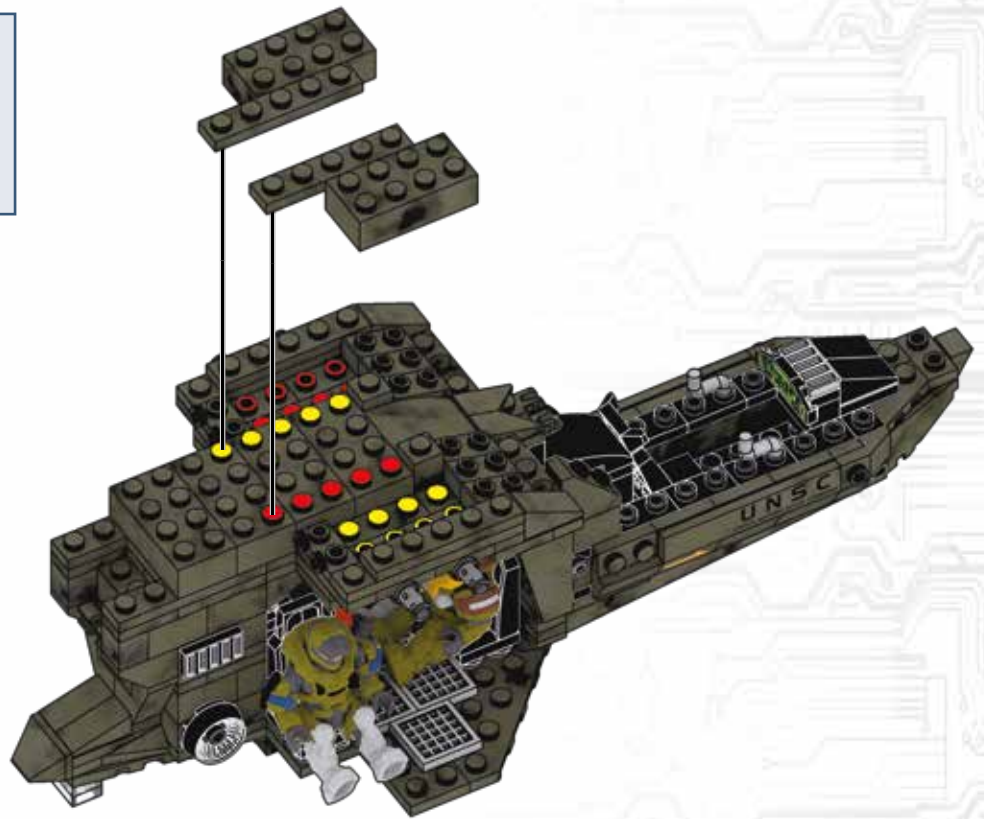

74



2X



1X



2X



75



2X



2X



2X



76



2X



2X

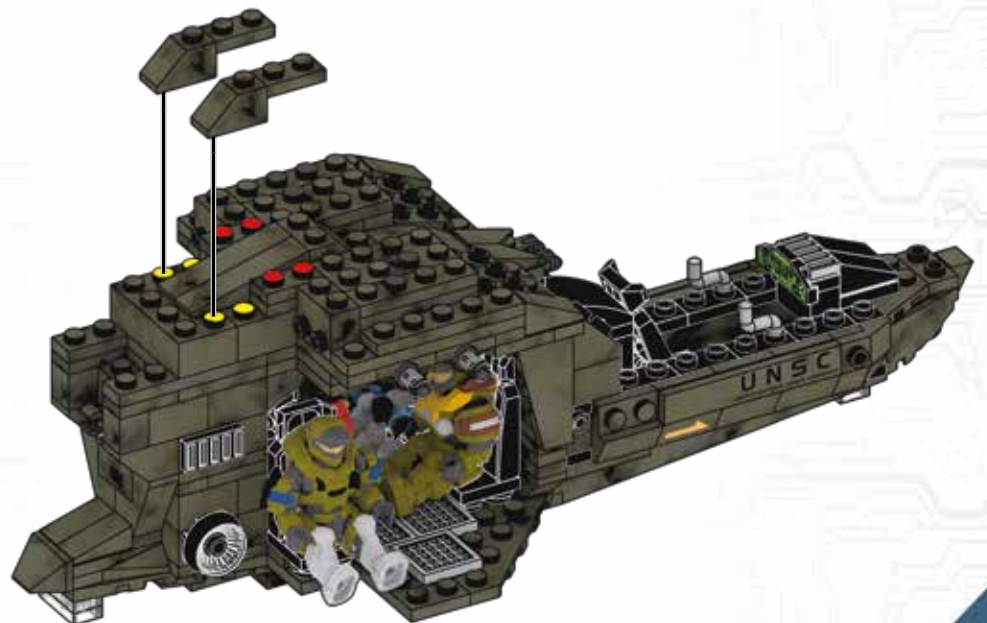

77

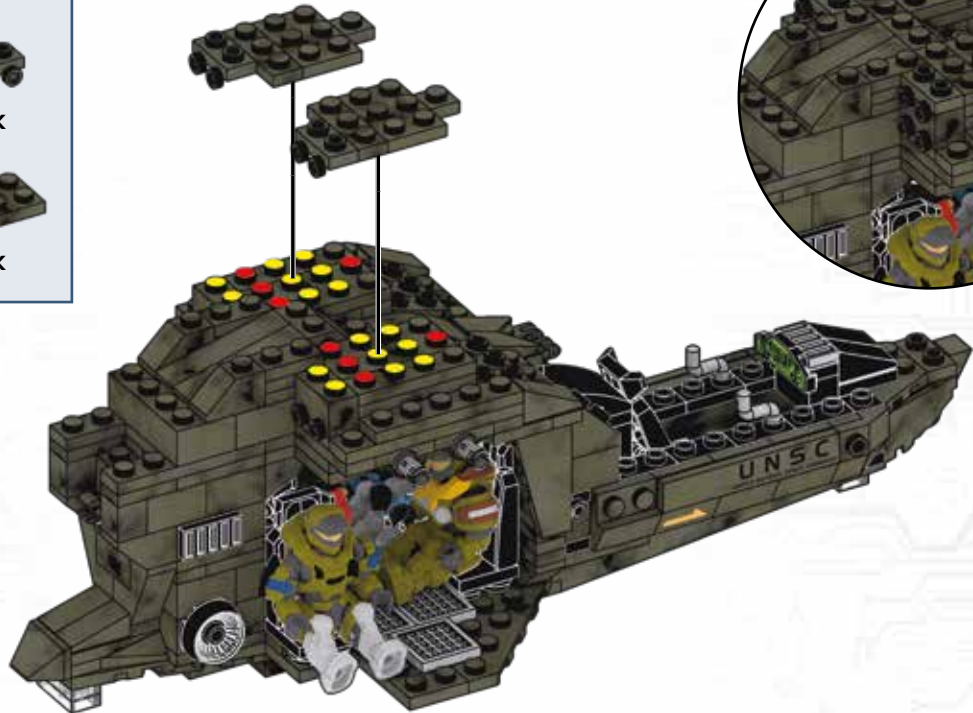
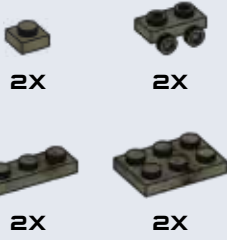

78

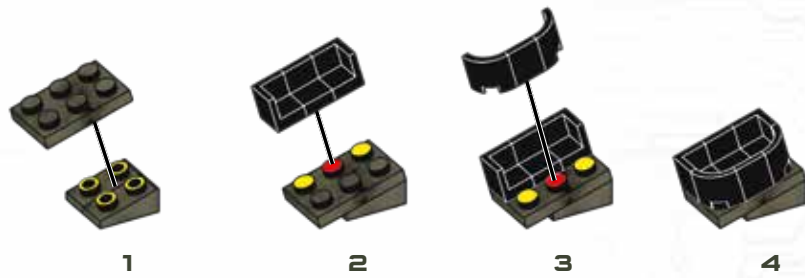

79

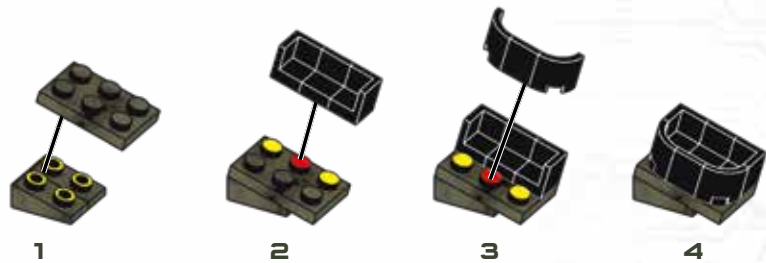
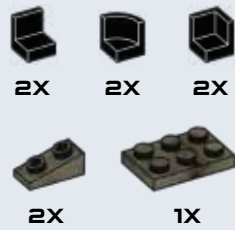

80

79

78



81



4X



2X



1X



1X



1



2

82

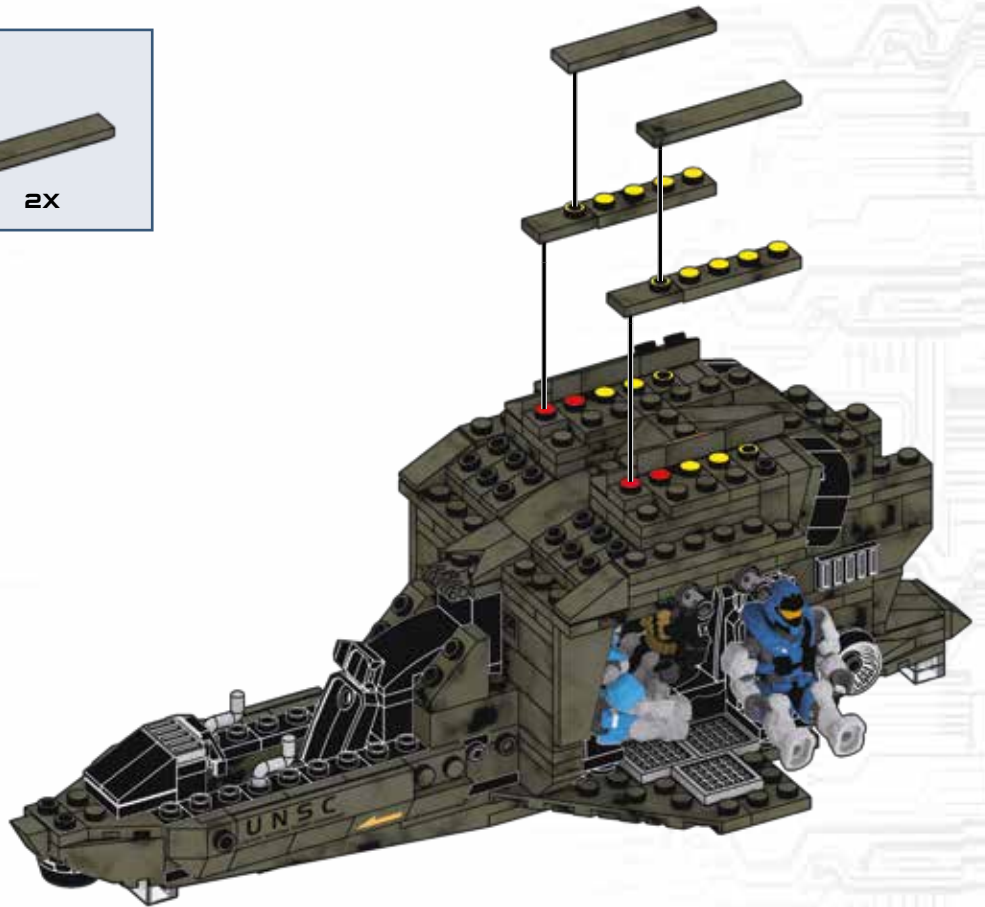

83

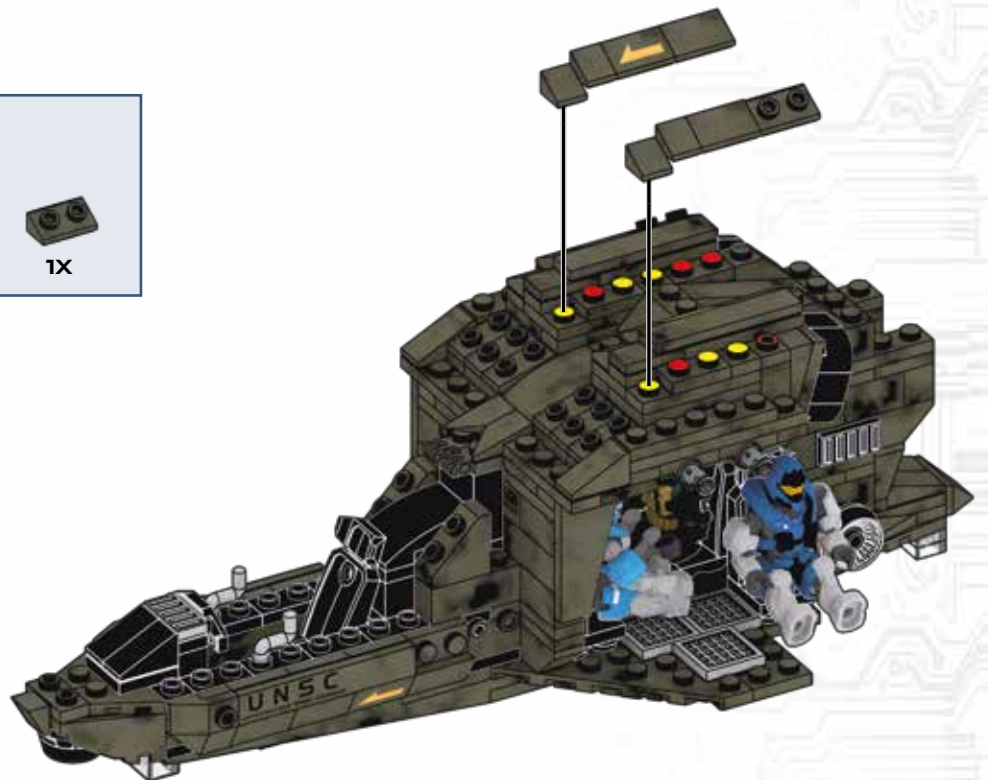
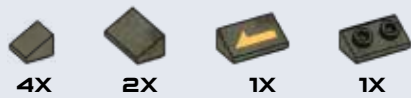



84

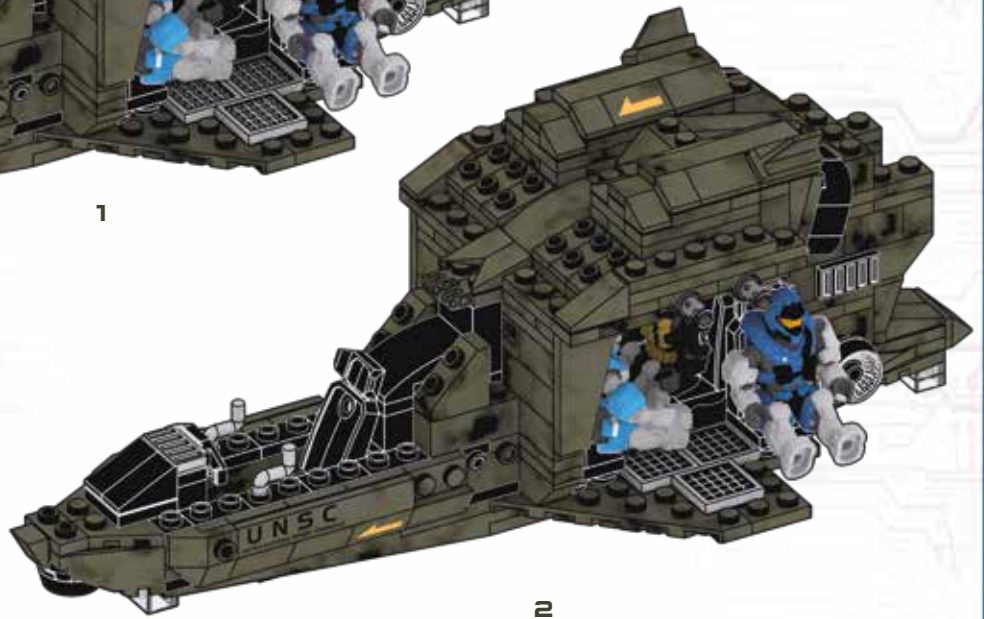
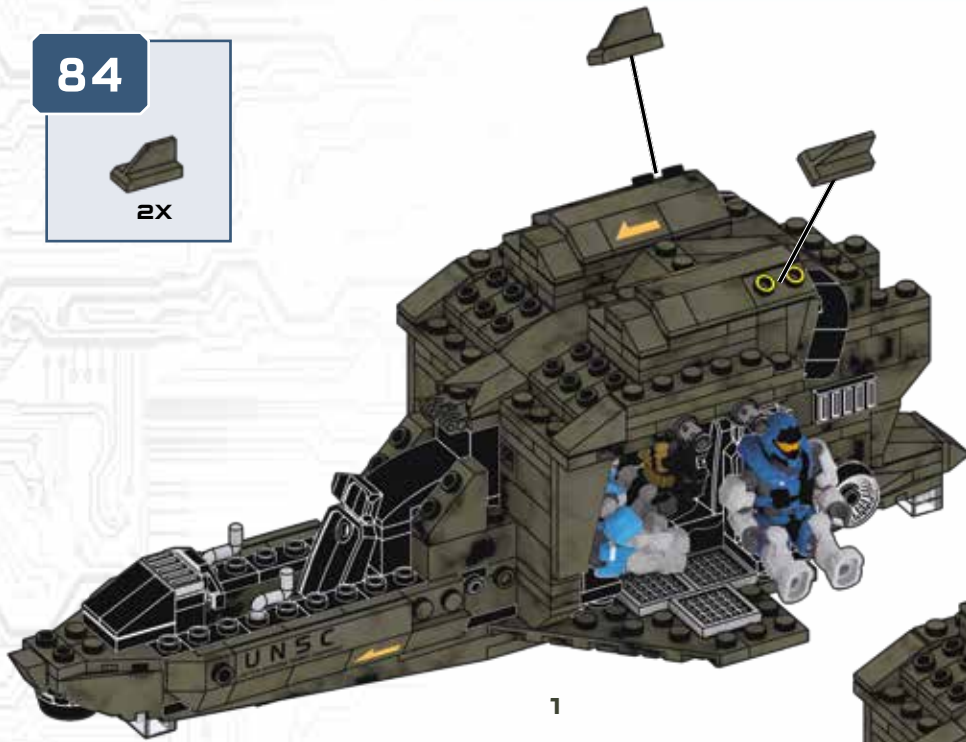

85





1



2

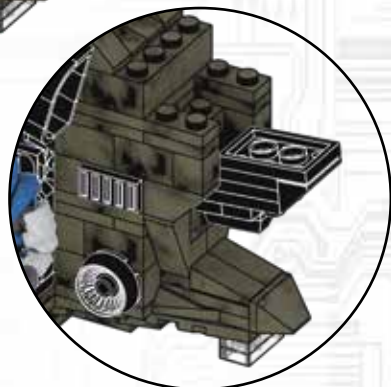



87

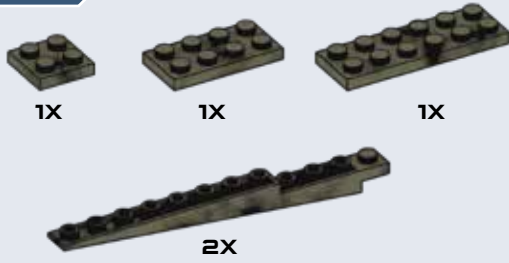

88

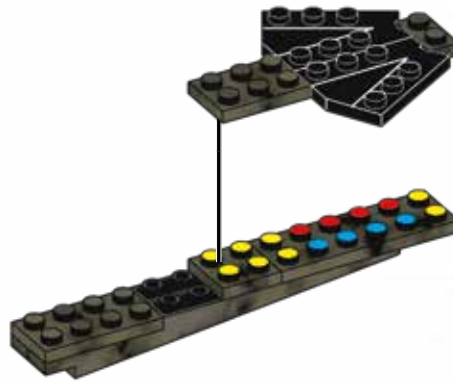

89

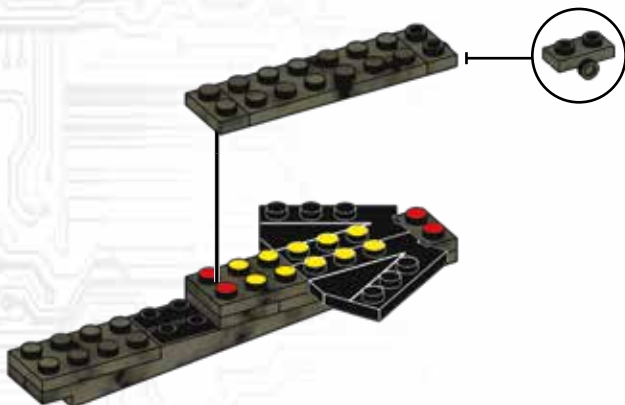

90



91

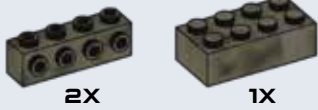

92



93

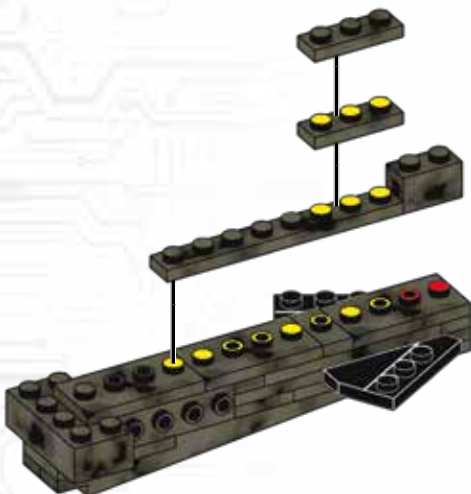

94

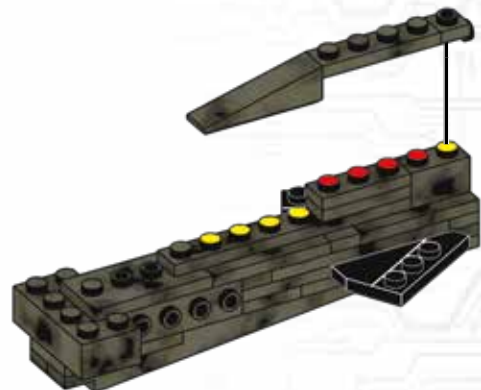

95

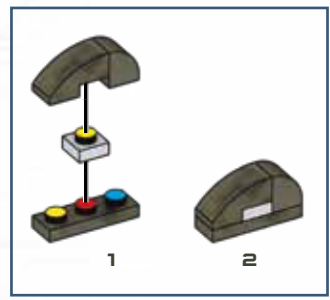

96

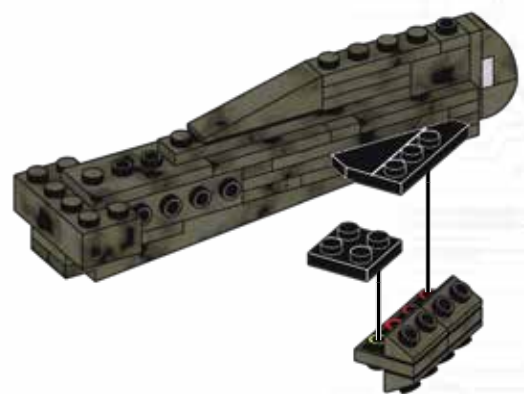
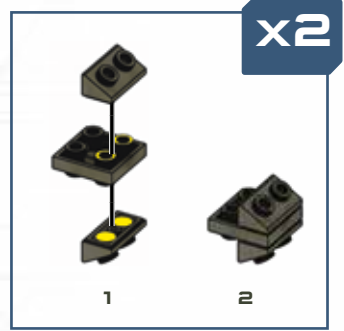

97

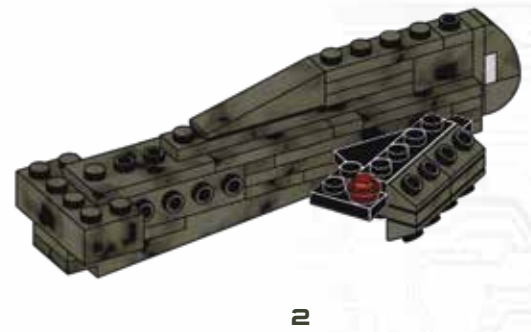
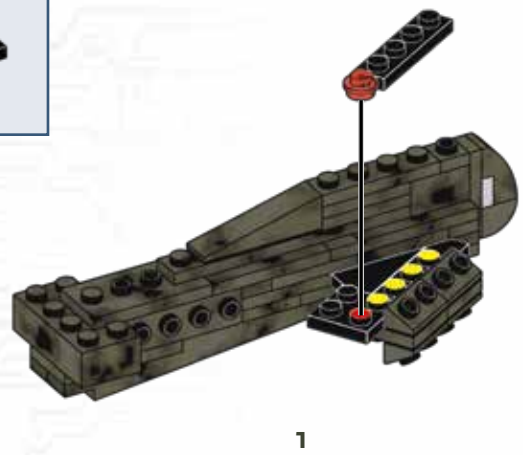

98

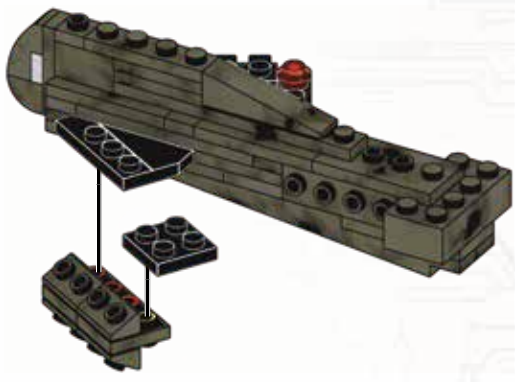

99

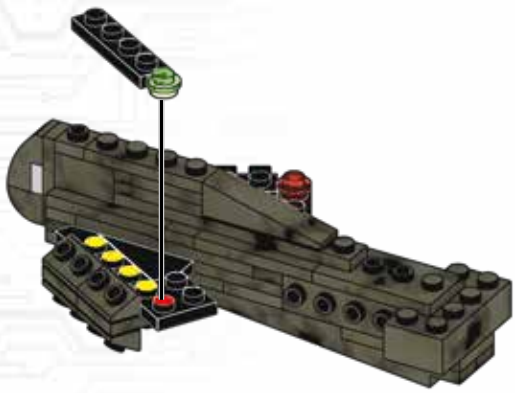

1

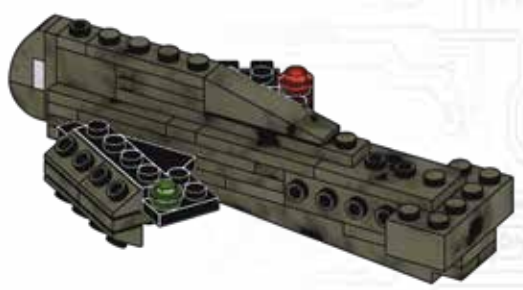

2

100



1X

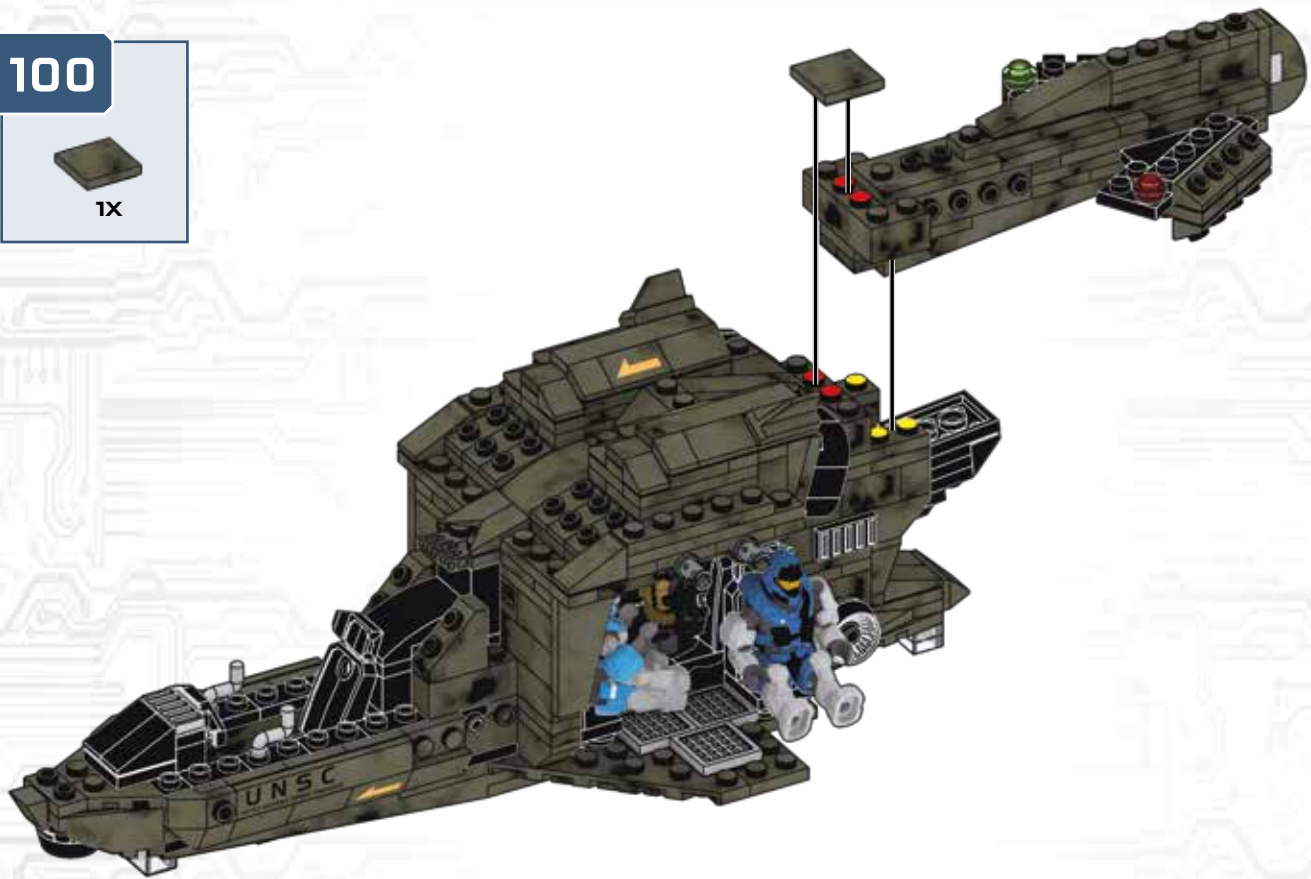

1



2

# 101



# 102



# 103





104



1X



1X

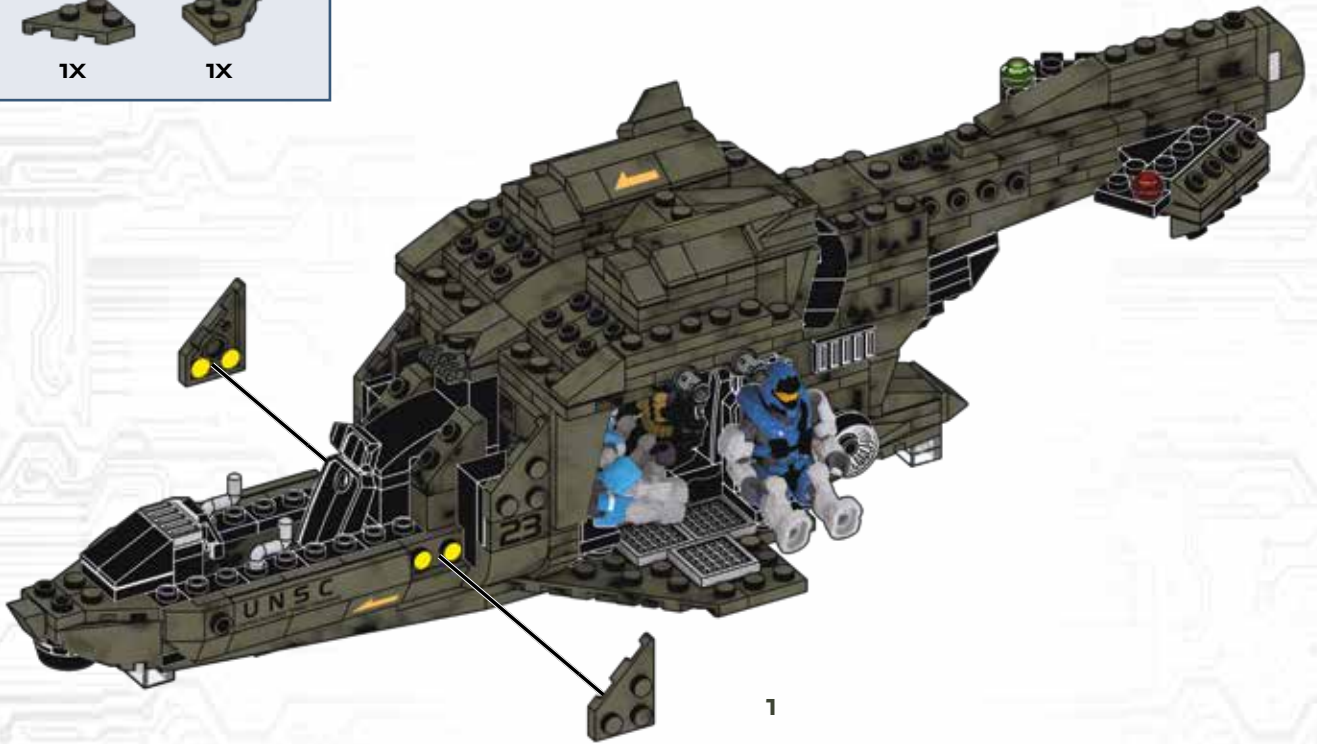

1



2

105

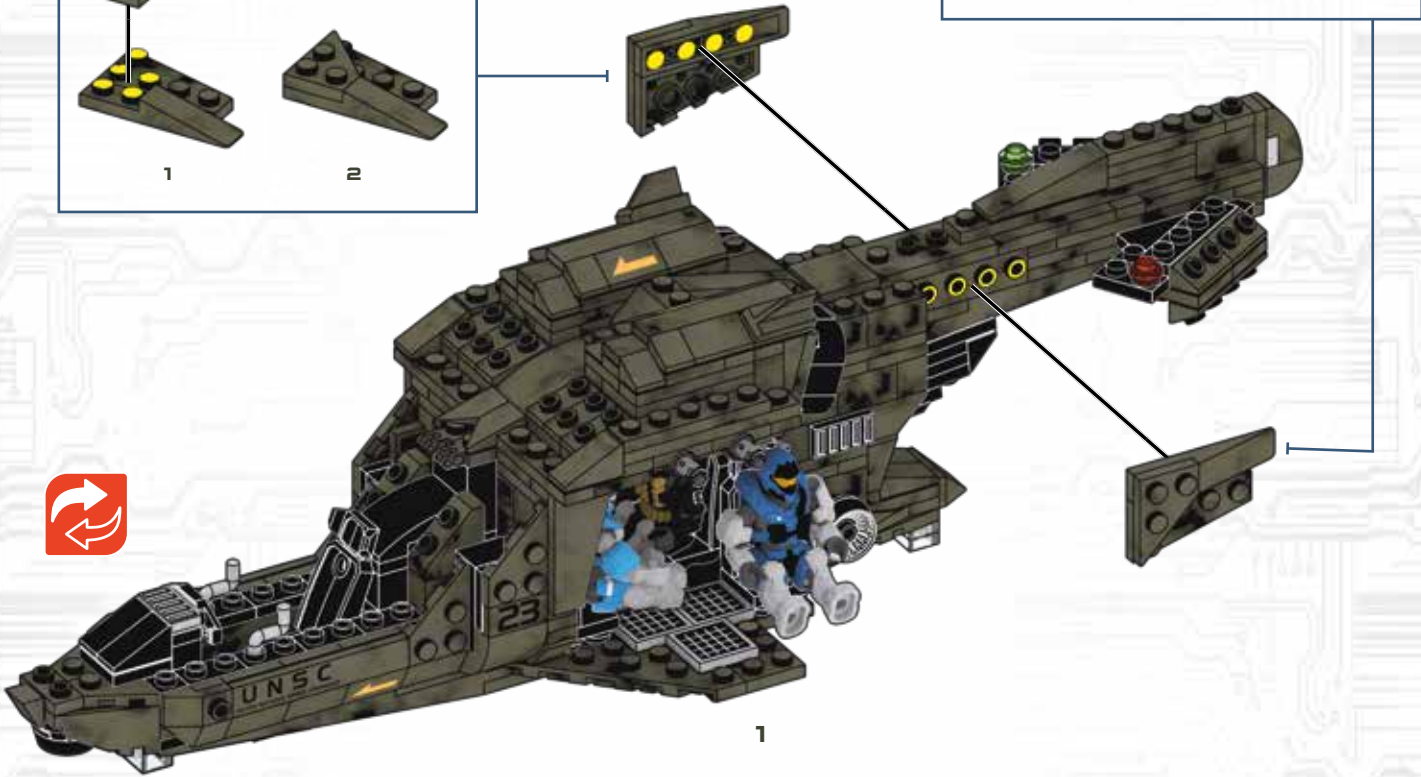
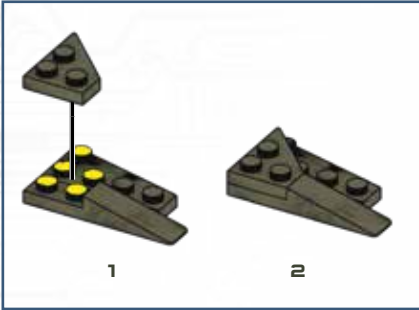
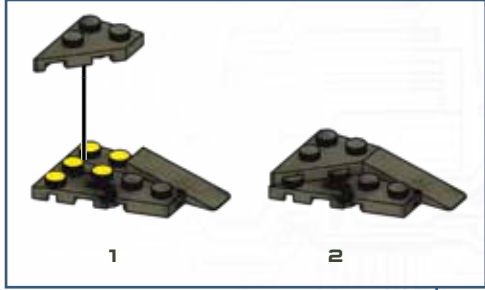



106



1X



1X



1X



1X



1X



1



2



3



4

107



2X

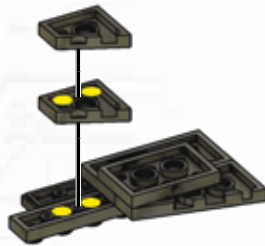

1



2

108



1X



1X



1X



1X



1X



1



2



3



4

109



2X

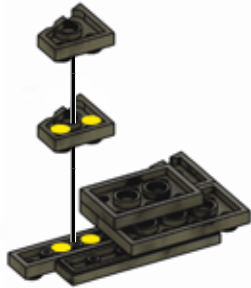

1



2

110

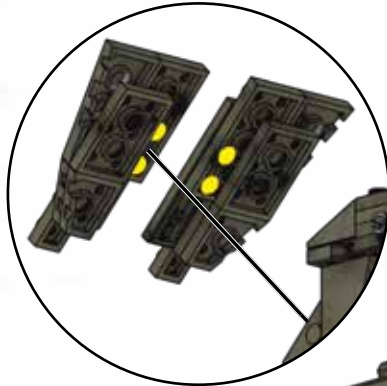

107

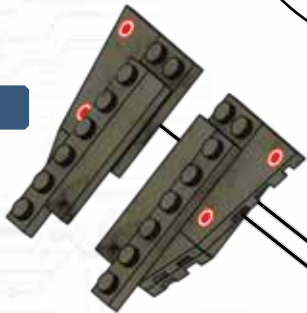

109

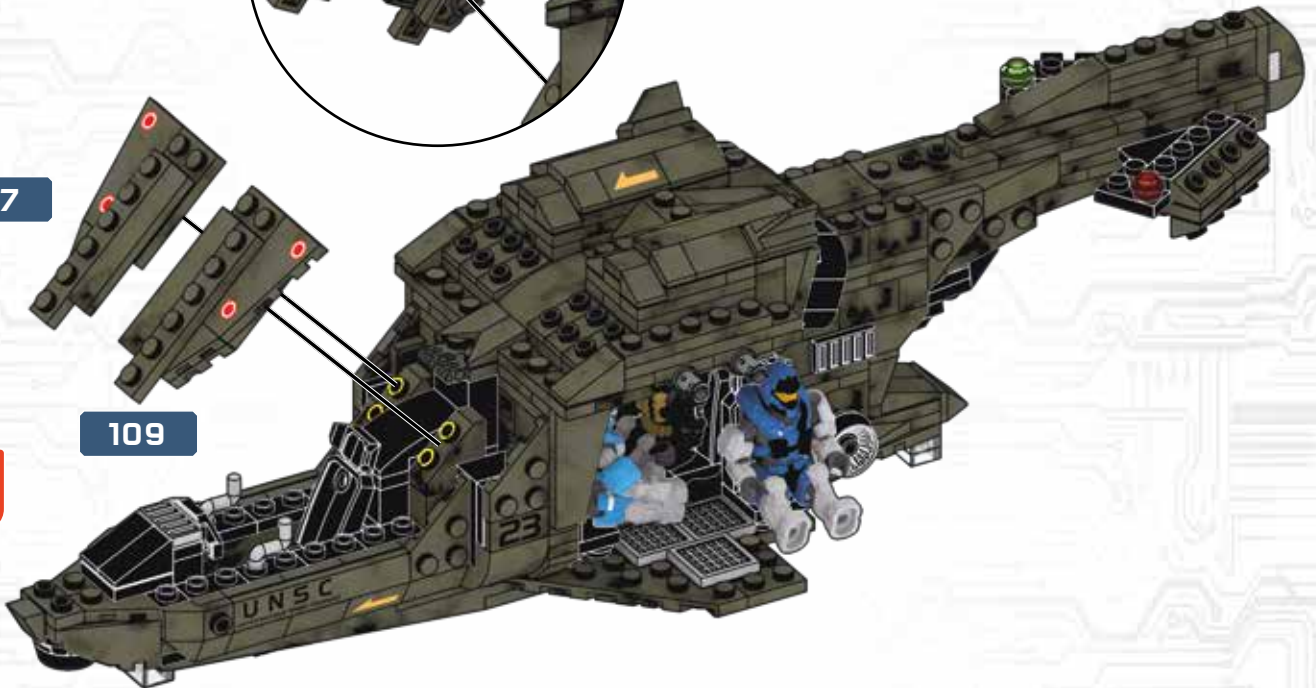

111

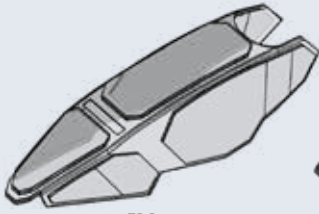

1X



1X

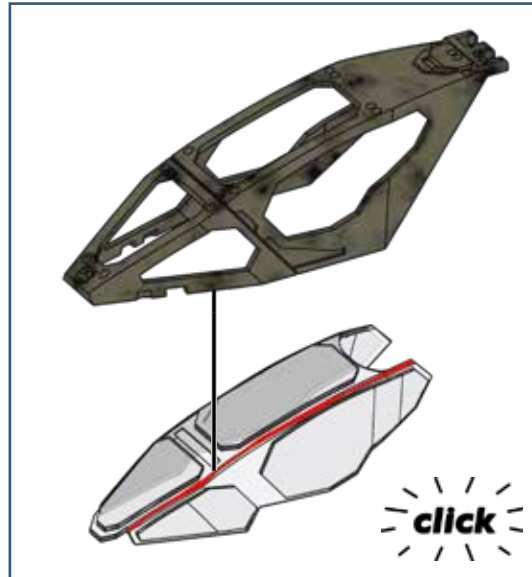

112



1X



1X



1



2

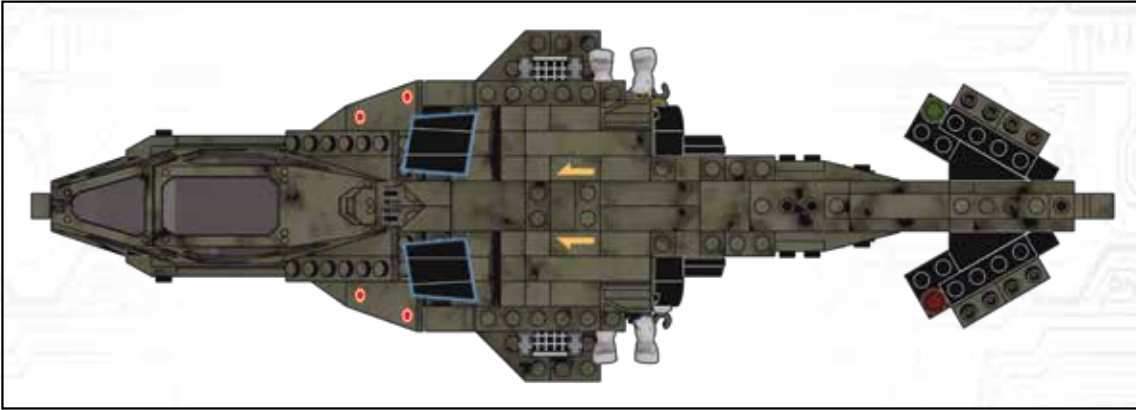

# 113

Remove temporary pieces.  
Retirer les pièces temporaires.  
Retirar las piezas provisionales.  
Remover as peças temporárias.  
Rimuovere i pezzi provvisori.  
Die vorübergehend benötigten Teile entfernen.  
Usunąć elementy tymczasowe.  
Verwijder tijdelijke delen.  
Удалите временные детали.  
Αφαιρέστε τα προσωρινά κομμάτια.  
Geçici parçaları çıkarın.  
Odstráňte dočasné diely.  
Vyberte dočasné kusy.  
Távolítsa el az ideiglenes darabokat.  
暫定ピースを外してください

## 移除临时件



# 114

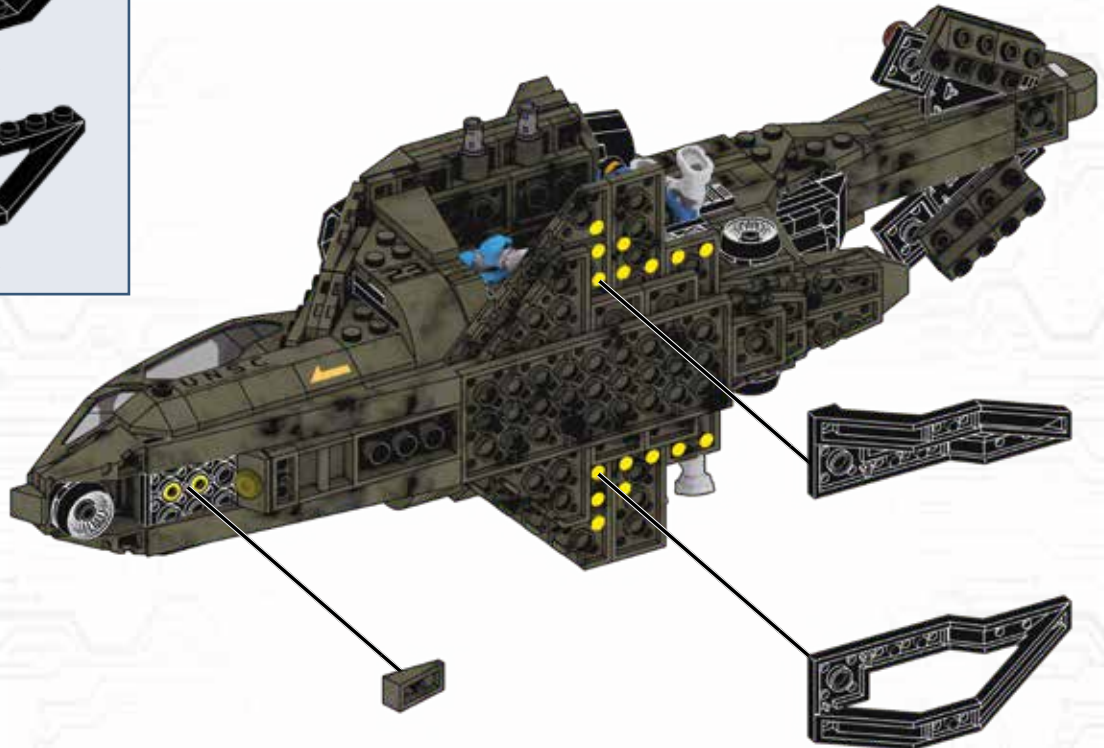
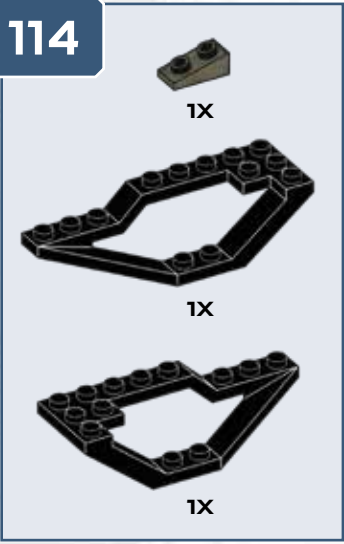

115



2x

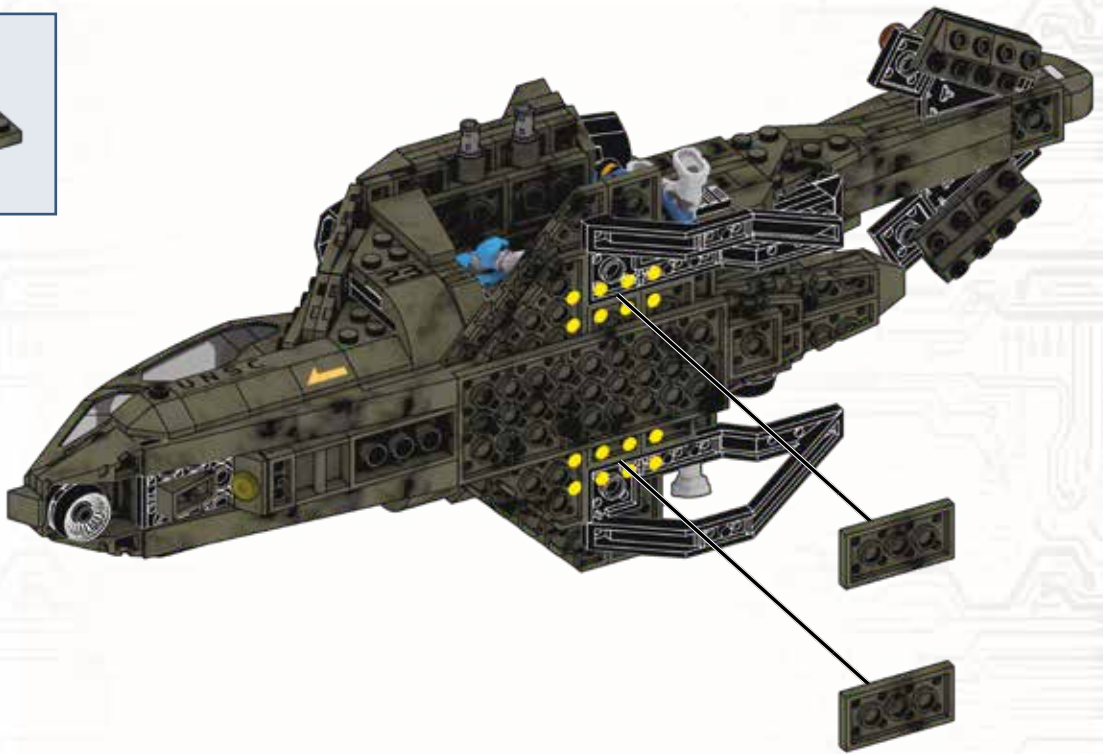

116



2x



1x



1x





117



1X



1X



1X



1X

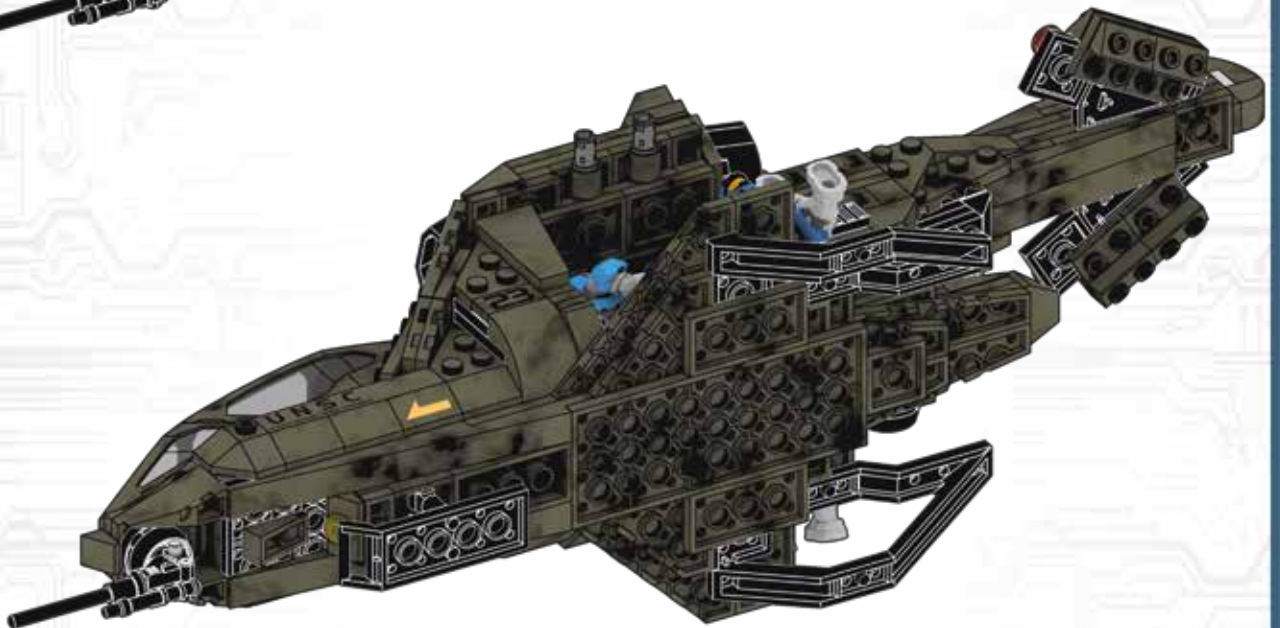
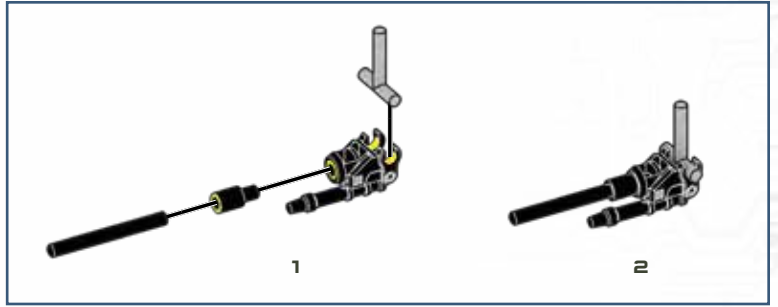

118

x2

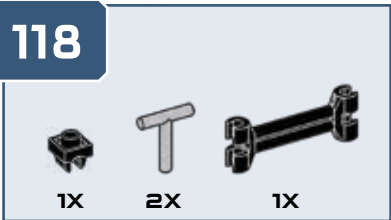

1

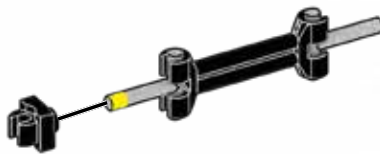

2



3

119

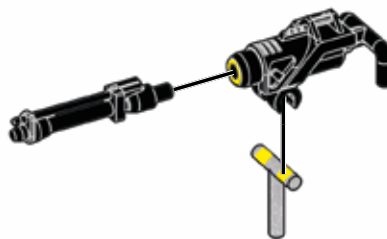

1



2

120

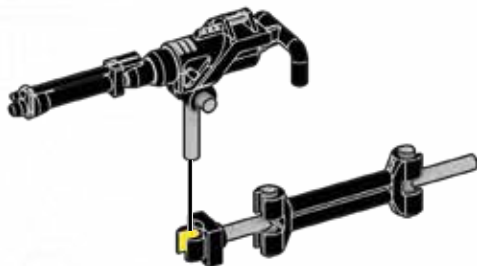

1



2





122



2x



1



2

123



1X



1X



1



2

124

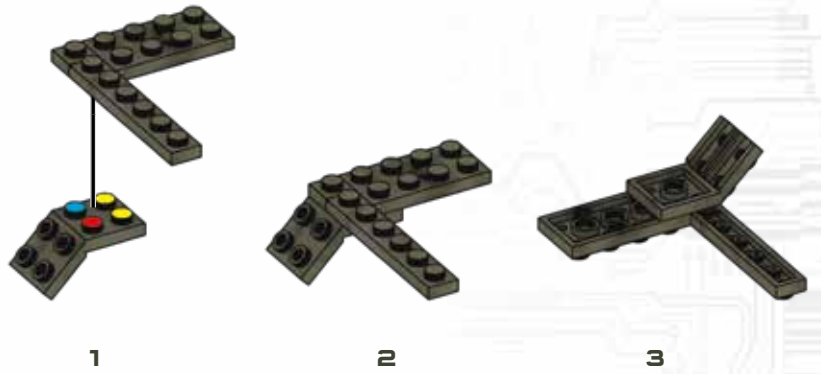
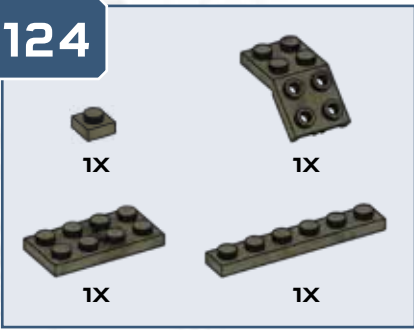

125

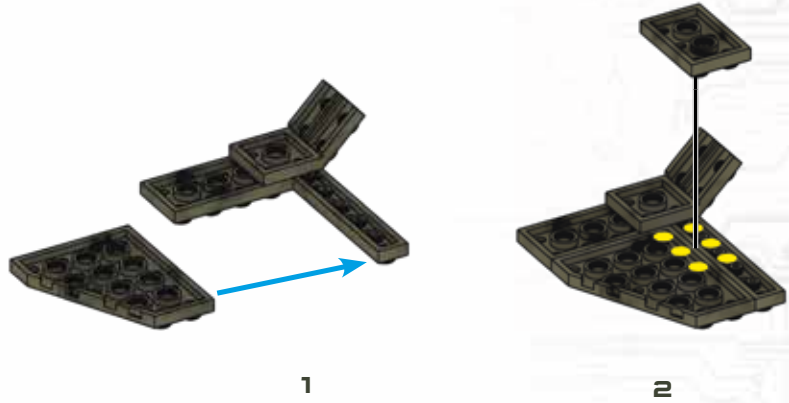

126

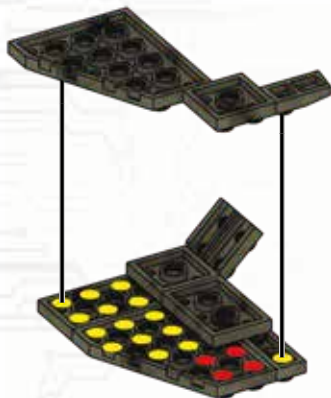
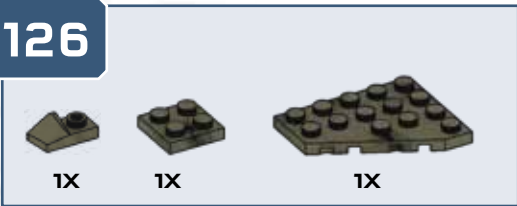

127

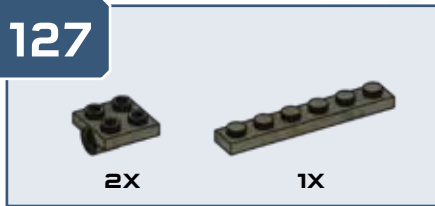

128



129

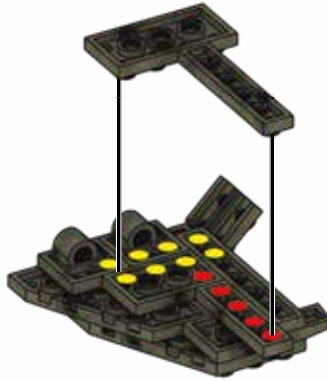

1



2

130

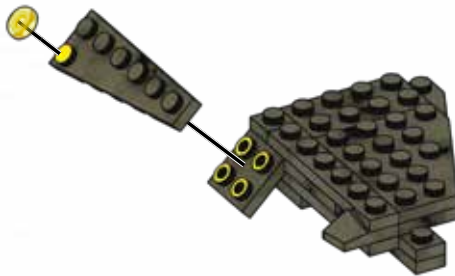
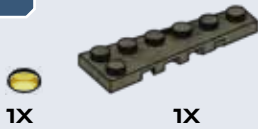

131



132



133

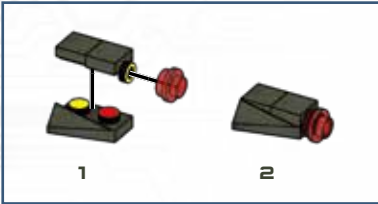

134

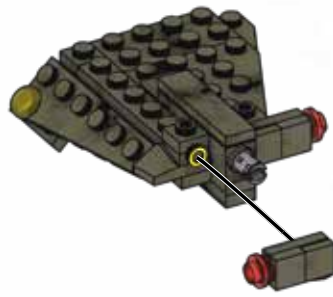
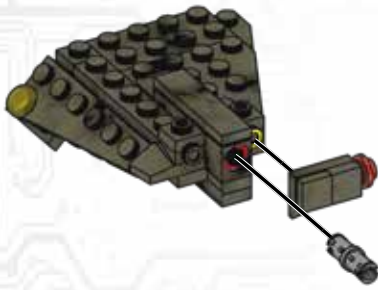
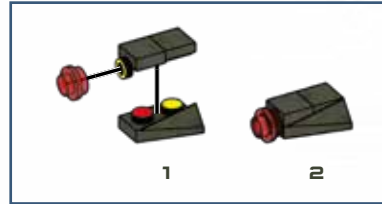
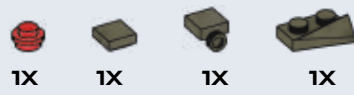

1

2

135

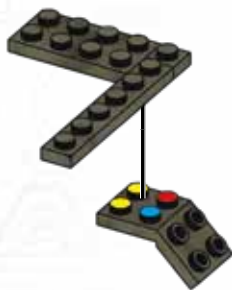
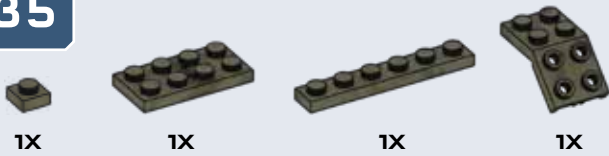

1

2

3



136

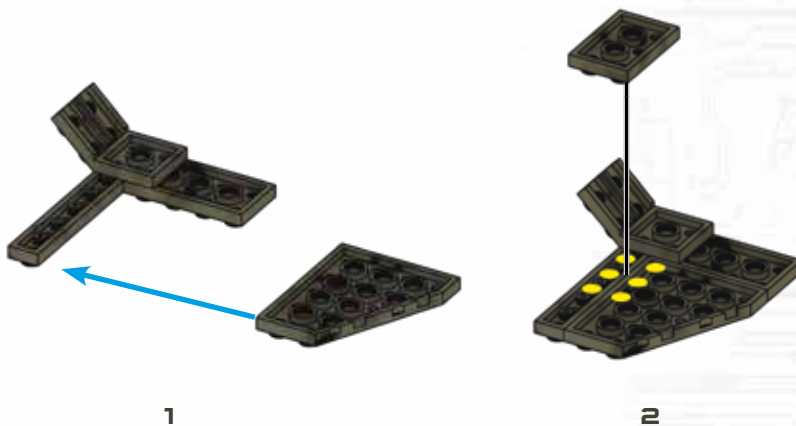

137



138



139

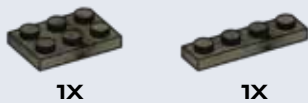

140

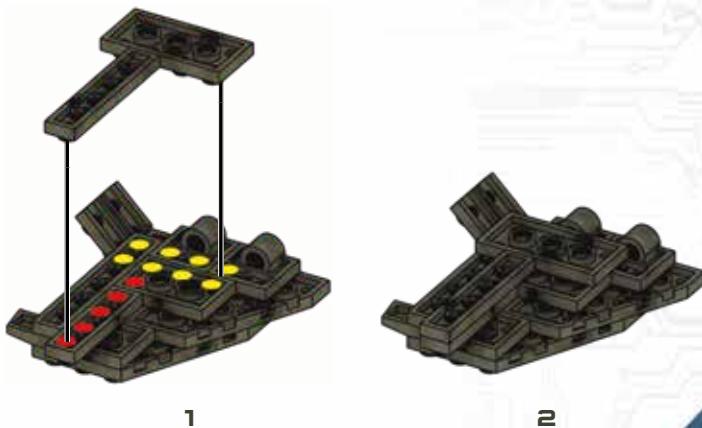

141

1X



1X

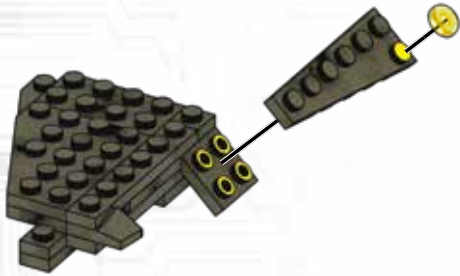

142

1X



2X



1X



143

1X



1X

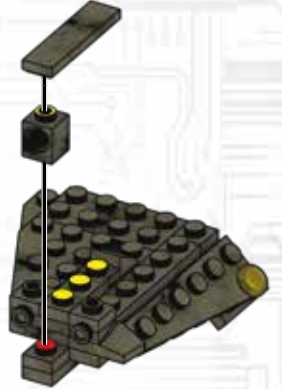

144

1X



1X



1X



1X



1X

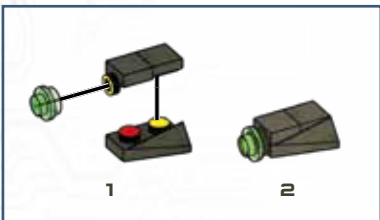

1

2

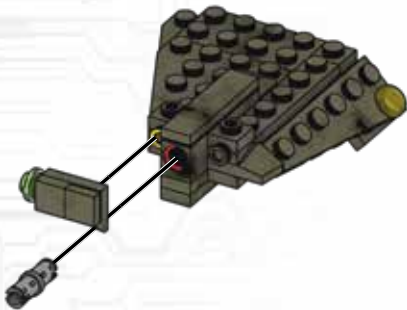

145

1X



1X



1X



1X

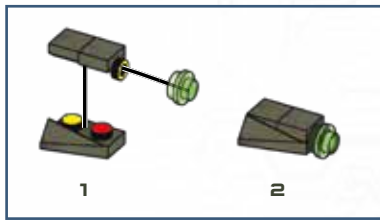

1

2

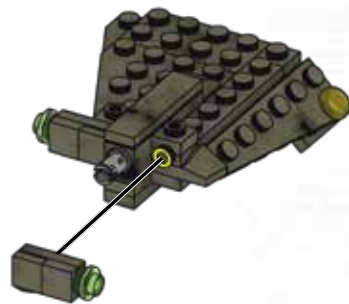

1



2

146



1



2



**147**

1X 1X 2X



**148**

2X



**149**

1X 1X



**150**

1X



**151**

2X 1X



**152**

1X 1X

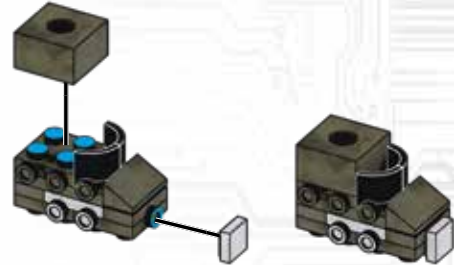

1

2

**153**

1X 1X



**154**

1X 2X



# 155



2X



1X



1X



1



2



3

# 156



1X



1X

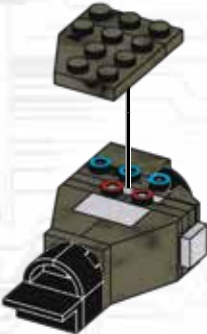

# 157



1X



1X



1



2

# 158



1X

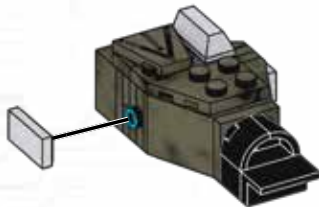

1



2

159



160



161



162



163



164

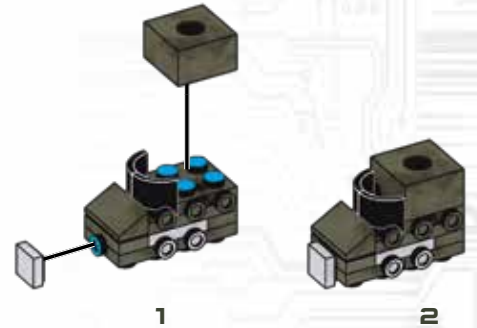

165

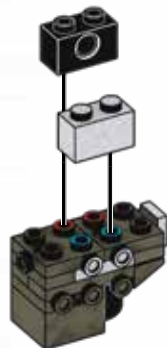

166



# 167



2X



1X



1X



1



2



3

# 168



1X



1X

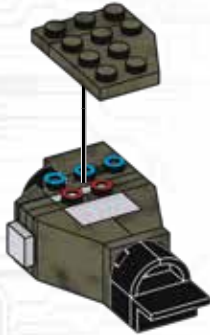

# 169



1X



1X



1



2

# 170



1X

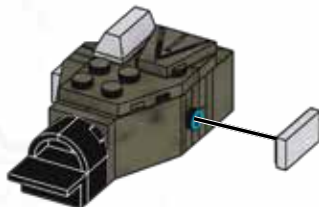

1



2

171





172



2X



2X



2X



6X

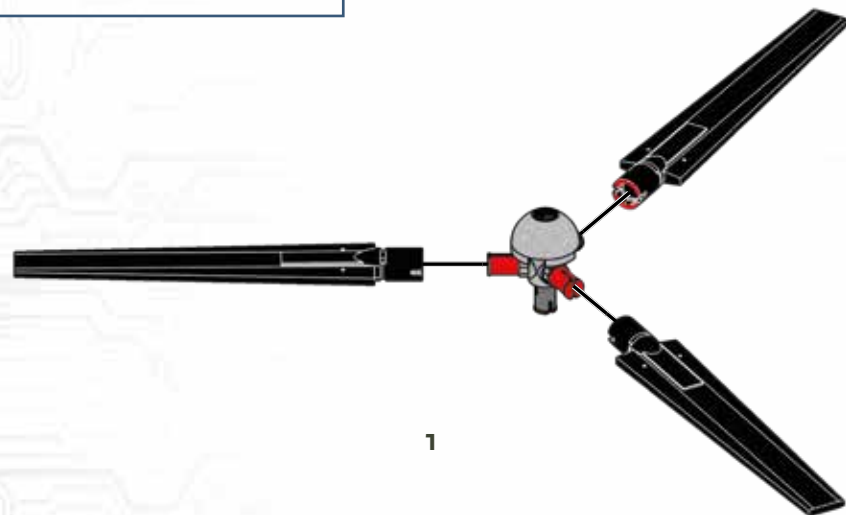
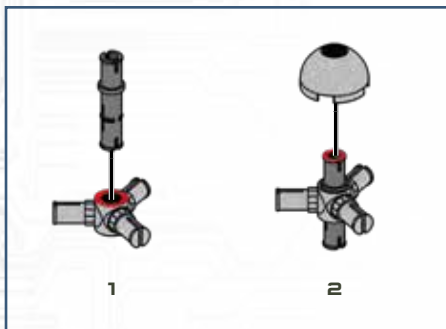

1



2

x2



1



2





SPARTAN  
CARTER-A259



SPARTAN  
JUN-A266



SPARTAN  
KAT-B320



SPARTAN  
EMILE-A239



SPARTAN  
JORGE-059



SPARTAN  
NOBLE SIX



## NOBLE TEAM ÉQUIPE NOBLE

ЕQUIPO NOBLE • EQUIPA NOBLE • КОМАНДА "НОУБЛ"

5x AM17003F

3x AM74397F

3x AM75332ZD

8x AM01113F

3x AM01113WH

3x AM01113X

2x AM0910ZD

2x AM07223APG

4x AM07223APD

6x AM03328APD

1x AM03328APG

2x AM79666APG

4x AM79665APD

2x AM77574F

7x AM77574APD

2x AM18623F

11x AM17127APD

1x AM07659APD

2x AM80356APD

6x AM01086APD

4x AM15485F

12x AM81323F

4x AM76959F

1x AM72090F

7x AM18628APG

2x AM73904APG

1x AM73013F

2x AS-HDP62-04

2x AM022501APG

1x AM09198APG

2x AM09198F

1x AM18756APG

2x AM73758APD

5x AM07590F

1x AM07590APD

21x AM09393APD

2x AM09393W

2x AM09393F

6x AM78926APD

4x AM79070APD

1x AM79070F

10x AM76467F

5x AM76467APD

2x AM76467APG

3x AM15480APD

3x AM15481APD

1x AM17130APD

1x AM17129APD

11x AM80573APD

2x AM17128APD

1x AM72494APD

1x AM72495APD

6x AM73534BDG

3x AM18232F

2x AM18232APG

2x AM07228F

2x AM18269APD

3x AM18665APD

3x AM18666APD

1x AM19380F

3x AM17010F

2x AM18266APG

10x AM18272APD

1x AM73989APD

6x AM18549APD

1x AS-HDP62-07

1x AS-HDP62-08

1x AM03019F

1x AM19061APD

2x AM04430F

2x AM04430APD

2x AM18710APD

4x AM01417APD

2x AM01322APD

1x AM17788APD

2x AM18601APD

2x AM79877F

1x AM09013W

4x AM09013F

12x AM09013APD

2x AM09013APG

2x AM17502APD

1x AM09835F

2x AM18554APD

4x AM15484APD

2x AS-HDP62-15

1x AS-HDP62-01

2x AM04218APD

2x AM18658APD

2x AM08480APD

1x AM18543MM

1x AM0948APD

8x AM18525APG

10x AM03773APD

4x AM03773F

8x AM01146APD

6x AM09268F

2x AM18264APG

2x AM18265BDG

1x AM18527APD

2x AM18300APD

1x AM09023F

1x AM10273APD

2x AM16653APD

6x AM78189APD

1x AS-HDP62-11

1x AS-HDP62-12

1x AM18328APD

1x AM18329F

8x AM79952APD

2x AM80748APD

20x AM01314APD

2x AM01314F

2x AM81259APD

3x AM76205APD

3x AM76206APD

1x AM17073APD

1x AM17074APD

1x AM76521F

1x AM18526F

- 2x  AM18289F
- 2x  AM18290F
- 24x  AM03772APD
- 1x  AM03772F
- 2x  AM03873APD
- 2x  AM03873F
- 1x  AM17021APD
- 1x  AM17021F
- 1x  AM17021F
- 1x  AM18273MM
- 6x  AM17049F
- 4x  AM18562APD
- 2x  AM08481APD
- 2x  AM79973F
- 6x  AM74718MY

- 1x  AM18282APD
- 1x  AM18283APD
- 2x  AM18288F
- 1x  AS-HDP62-02
- 1x  AS-HDP62-03
- 3x  AM16959APD
- 3x  AM17503APD
- 5x  AM01087APD
- 1x  AM09593AUK
- 11x  AM09593APD
- 2x  AM09593F
- 2x  AM09838APD
- 6x  AM76357AUK
- 2x  AM09033F
- 12x  AM09033APD

- 4x  AM01531APD
- 2x  AM09493F
- 14x  AM09493APD
- 1x  AM77321APD
- 1x  AS-HDP62-10
- 1x  AM77320APD
- 1x  AS-HDP62-09
- 2x  AM74064APD
- 2x  AM74065APD
- 9x  AM07475APD
- 2x  AM15492APD
- 4x  AM17793APD
- 1x  AS-HDP62-06
- 1x  AS-HDP62-05
- 2x  AM18270APD

- 1x  AS-HDP62-13
- 1x  AS-HDP62-14
- 2x  AM76849APD
- 8x  AM09292APD
- 7x  AM01480APD
- 2x  AM72010APD
- 2x  AM72011APD

- 2x  AM18280APD
- 2x  AM18281APD
- 1x  AM18546APD
- 1x  AM18292F
- 1x  AM17055APD
- 2x  AM04219APD
- 3x  AM08483APD

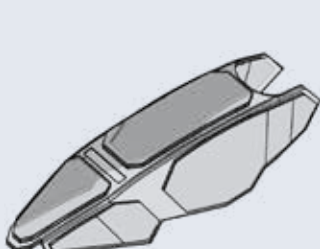
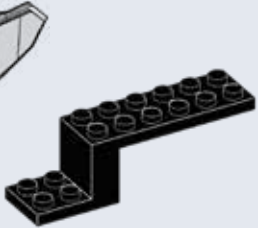
- 1x  AM18262APD
- 1x  AM18261AGY
- 2x  AM80747F

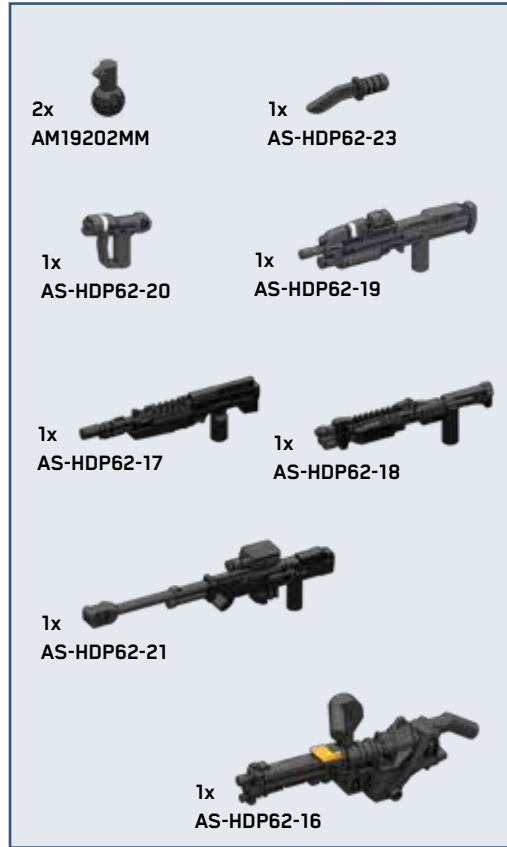
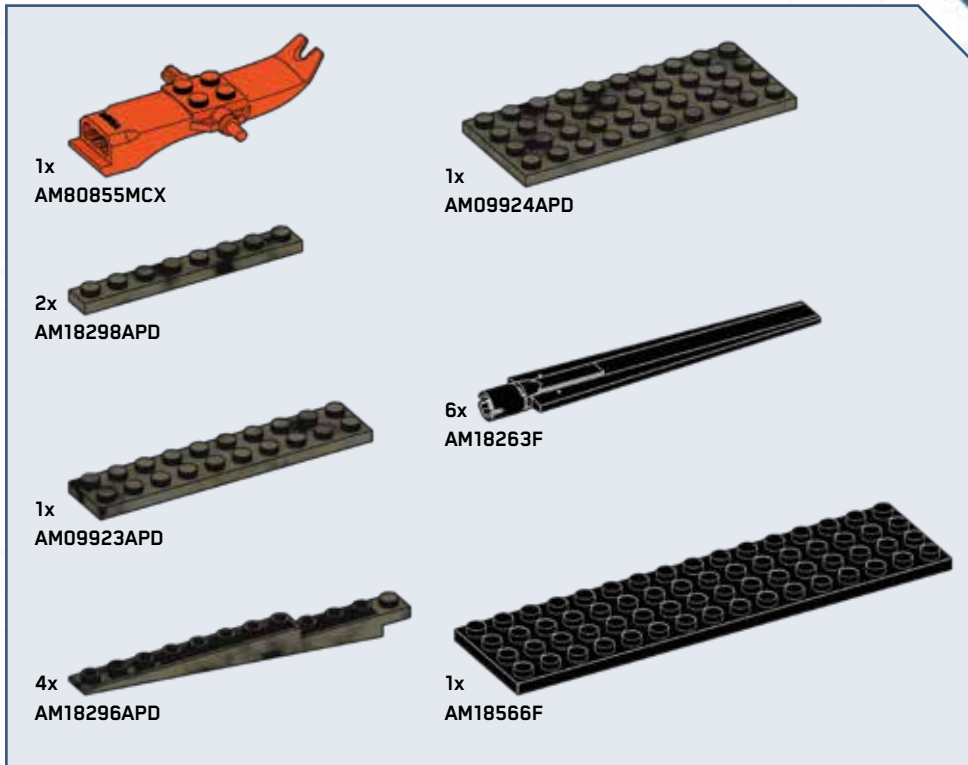
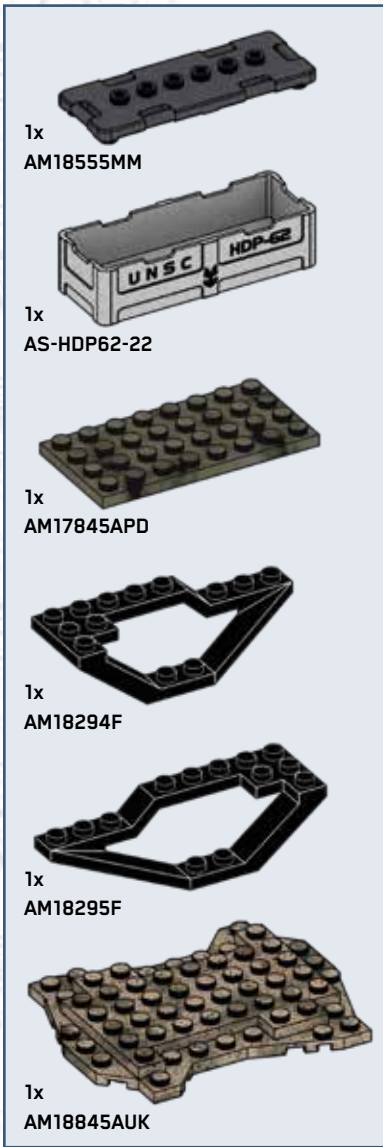

**Missing pieces?**  
**Pièces manquantes?**  
 ¿Partes faltantes? • Perdeu peças?  
 Fehlen Teile? • Не хватает деталей?  
[support.megabrands.com](http://support.megabrands.com)



# HALO

More to collect!  
 Encore plus à collectionner!  
 ¡Más para coleccionar! / Mais para coleccionar!  
 Mehr zum sammeln! / Собери больше!



HDP54

HDH92

Set(s) sold separately and subject to availability. / Ensemble(s) vendu(s) séparément. Certains produits peuvent ne pas être commercialisés. / Se vende(n) por separado y está(n) sujeto(s) a disponibilidad. Conjunto(s) vendido(s) em separado e sujeito(s) à disponibilidade. / Set in vendita separatamente, secondo disponibilità. / Das/Die Set(s) sind separat erhältlich. / Zestaw(y) sprzedawany(e) oddzielnie w zależności od dostępności. / Set(s) apart verkrijgbaar en afhankelijk van beschikbaarheid. / Набор(-ы) продаются отдельно, при наличии. / Sæt sælges separat og så længe lager haves. / Seten säljs separat så länge lagret räcker. / Settett/settene selges separat så langt lageret rekker. / Pakkaus/pakkaukset myydään erikseen, saatavuus voi vaihdella. / Το(α) σετ πωλούνται ξεχωριστά και ανάλογα με τη διαθεσιμότητα. / Setler ayrı olarak satılır ve stoklarla sınırlıdır. / Set (sety) se prodává (prodávají) samostatně dle aktuální nabídky. / Súprava/-y sa predáva(jú) samostatne a podľa dostupnosti. / A készlet(ek) külön kapható(k), az elérhetőség változhat.

セット商品は別売りになります。在庫状況は別途ご確認をお願いします。

تباع المجموعة أو المجموعات على حدة وتخضع لتوافرها.

每套单独发售，按供货情况决定。

1186 MJ, 1, NL



XBOX

343 INDUSTRIES™



© 2021 Microsoft Corporation. All Rights Reserved. Microsoft, Halo, the Halo logo, Xbox, the Xbox logo, and 343 Industries are trademarks of the Microsoft group of companies.

UNSC Falcon Sweep • L'attaque du UNSC Falcon  
 UNSC Falcon de búsqueda • Ofensiva do UNSC Falcon  
 Falcon UNSC da incursione • Akcja UNSC Falcon • Gevechtsoperatie met de UNSC Falcon  
 Наступление вертолета Falcon UNSC • UNSC Falcon Mücadelesi • AZ UNSC Falcon lecsap  
 UNSC Falcon-togt • الساق UNSC Falcon انتصار

Mattel Europa B.V., Gondel 1, 1186 MJ Amstelveen, Nederland. Mattel U.K. Limited, The Porter Building, 1 Brunel Way, Slough SL1 1FQ, UK. Mattel France, Parc de la Cerisaie, 1/3/5 allée des Fleurs, 94260 Fresnes Cedex, N° Cristal 0969 36 99 99 (Numéro non surtaxé) ou www.lesjouetsmattel.fr. Mattel Belgium, Trade Mart, Atomiumsquare, Bogota 202 - B 275, 1020 Brussels. Gratis nummer België: 0800 - 16 936 - Gratis nummer Luxemburg: 800 - 22 784 - Gratis nummer Nederland: 0800 - 262 88 35. Deutschland - Mattel GmbH, Solmsstraße 4, D-60486 Frankfurt am Main. Schweiz: Mattel AG, Kirchstrasse 24, CH-3097 Liebefeld, Österreich: Mattel Ges.m.b.H., Campus 21, Liebermannstraße A01 404, A- 2345 Brunn/Gebringe, Mattel Italy Srl, Via Bracco, 6-MAC 6, 20159 Milano, Italy. Servizio assistenza clienti: Customer.srv.italia@mattel.com - Numero verde 800 11 37 11. Mattel España, S.A., Aribau 200, 08036 Barcelona, c.service.spain@mattel.com Tel: 900 102 390 http://www.service.mattel.com/es. Mattel East Asia Ltd., Room 503-09, North Tower, World Finance Centre, Harbour City, Tsimshatsui, HK, China. Tel.: (852) 3185-6500. Diimport & Diedarkan Oleh: Mattel Continental Asia Sdn Bhd. Level 19, Tower 3, Avenue 7, No. 8 Jalan Kerinchi, Bangsar South, 59200 Kuala Lumpur, Malaysia. Mattel South Africa (PTY) LTD, Office 102 13, 30 Metrose Boulevard, Johannesburg 2196. Dystrybutor: Mattel Poland Sp. z o.o., Warsaw Trade Tower 34 p., ul. Chłodna 51, 00-867 Warszawa. Mattel Australia Pty. Ltd., 658 Church St., Richmond, Victoria, 3121. Consumer Advisory Service - 1300 135 312. Mattel AEBE, Εθνάρχου Μακαρίου 1, Κτήριο Κ-2, ΤΚ 17561, Παλαιά Φάληρο, Mattel Oyuncakçılık Tic. Ltd. Şti. İçerenköy Mah., Erkut Sok. A Blok No:12 Üner Plaza Kat:9-10 34752 Ataşehir İstanbul. Tel: 0216 570 75 00. Импортёр/Уполномоченная организация: ООО "МАТТЕЛ" Российская Федерация, 105120 Москва, 2-й Сыромятинский переулок, 1; +7 495 287 79 39. Mattel Czech Republic s.r.o., The Forum, Václavské nám. 19, 11000 Praha1. Mattel, 333 Continental Boulevard, El Segundo, CA 90245, USA. Mattel Canada Inc., Mississauga, Ontario L5R 3W2. Consumer Services: You may call us free at/ Composez sans frais le 1-800-524-8697. Importado e distribuido por Mattel de México, S.A. de C.V., Miguel de Cervantes Saavedra No. 193, Pisos 10 y 11, Col. Granada, Alcaldía Miguel Hidalgo, C.P. 11520, México, Ciudad de México. R.F.C. MME-920701-NB3. Tels: 59-05-51-00 Ext. 5206 ó 01-800-463-59-89. Mattel Chile, S.A., Avenida Americo Vesputcio 501-B, Quilicura, Santiago. Tel: 1230-020-6213. Servicio al consumidor Venezuela: Tel.: 0-800-100-9123. Mattel Argentina, S.A., Av. Libertador 1000, Piso 11 - Oficinas 109 y 111, Vicente López - Prov. Buenos Aires. Tel.: 0800-666-3373. Mattel Colombia, S.A., Calle 123#7-07 P5, Bogotá. Tel.: 01800-710-2069. Mattel Perú, S.A., Av. Juan de Arona # 151, Centro Empresarial Juan de Arona, Torre C, Piso 7, Oficina 704, San Isidro, Lima 27, Perú. RUC: 20425853865. Reg. Importador: 02350-12-JUE-DIGESA. Tel.: 0800-54744. E-mail Latinoamérica: servicio.clientes@mattel.com. Mattel do Brasil Ltda.- CNPJ : 54.558.002/0001-20 - Rua Verbo Divino, 1488 - 2º. Andar - 04719-904 - Chácara Santo Antônio - São Paulo - SP - Brasil. Serviço de Atendimento ao Consumidor: fone 0800 575 0780. E-mail: sac.matteldobrazil@mattel.com

© D714,887, D781,964, D797,203, D841,101

©2021 MEGA Brands &™ MEGA Brands. CONSTRUX™ is owned by Mattel and used under license. CONSTRUX™ appartient à Mattel et est utilisée sous licence. Printed in China / Imprimé en Chine AD-HDP62-01A

Mattel Canada Inc. Mississauga, Ontario L5R 3W2. MADE IN CHINA. FABRIQUÉ EN CHINE. FABRICADO NA / HECHO EN CHINA. صنع في الصين. ÇIN'DE ÜRETİLMİŞTİR.

