



HKF94

AUDI RS6 GTO



Build Construisez

Construye | Constrói
Bauen | Стройте



Share Partagez

Comparte | Partilha
Teilen | Делитесь

Devices not included | Appareils non inclus
Dispositivos no incluido | Dispositivos não incluídos
Geräte nicht enthalten | Устройства не входят в комплект



Get creative! Soyez créatif!

¡Sé creativo! • seja criativo!
werde kreativ! • проявите
творческий подход!



Build ideas may use pieces from multiple sets (sold separately).
Les idées de construction peuvent nécessiter des pièces issues de
différents coffrets (vendus séparément).
Las ideas de construcción pueden utilizar piezas de varios conjuntos
(se venden por separado).
As ideias de construção podem utilizar peças de vários
conjuntos (vendidas em separado).
Für Bauideen sind möglicherweise Teile von mehreren
Sets nötig (separat erhältlich).
В идеях конструкций могут быть использованы детали
из разных наборов (продаются отдельно).

megaunboxed.com



1

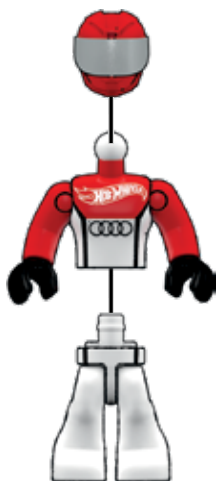

1



2

2

2x



2x



1x

x2

1



2

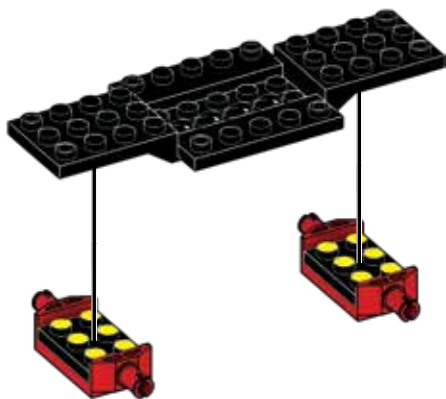

3



1x



1x

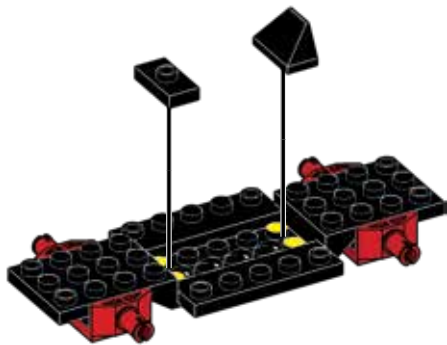

4



1x

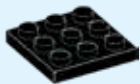

1x



1x

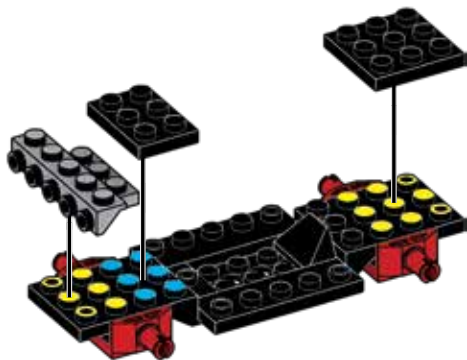

5



2x

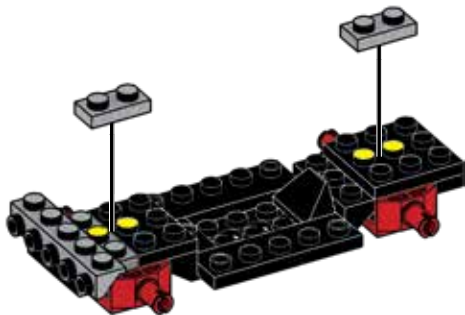

6



1x



2x

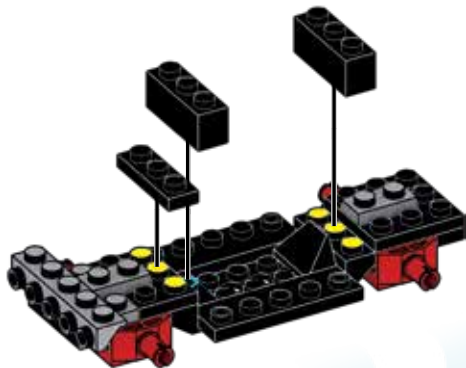

7



1x



1x



8



2x



2x



9



1x



1x

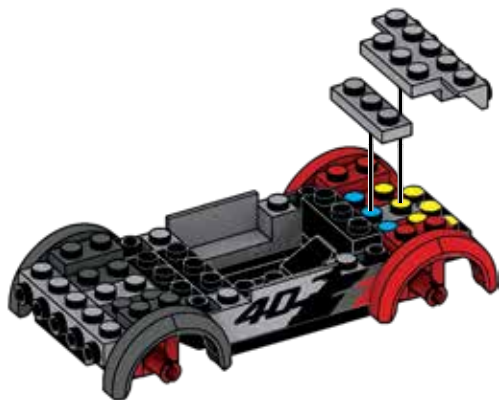

10



2x



11



1x



1x



1x



1x



12



1x



1x

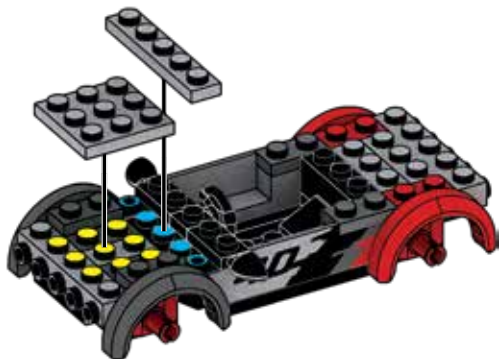

13



1x



1x



1x



1x



14



2x

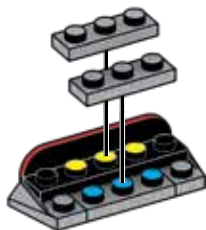

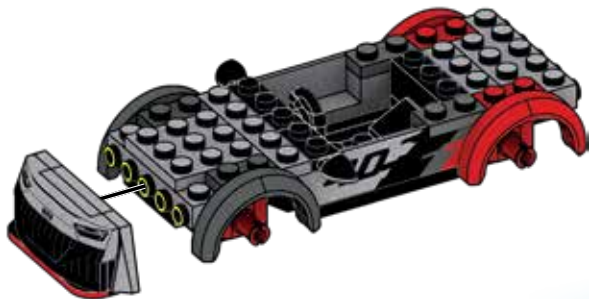
15**16**

17



1x



1x



1x

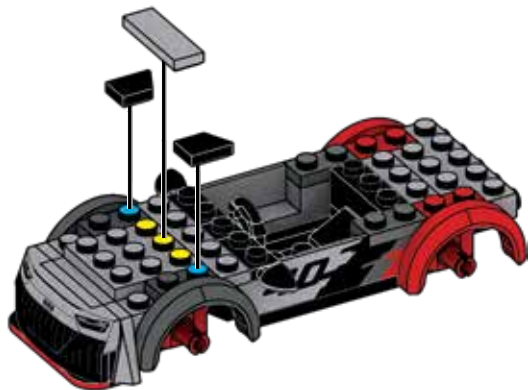

18



1x



2x

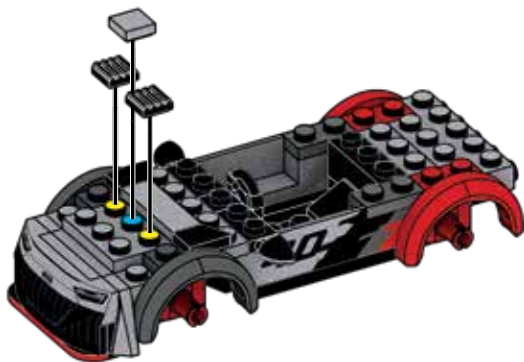

19



1x



1x

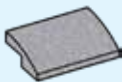

1x

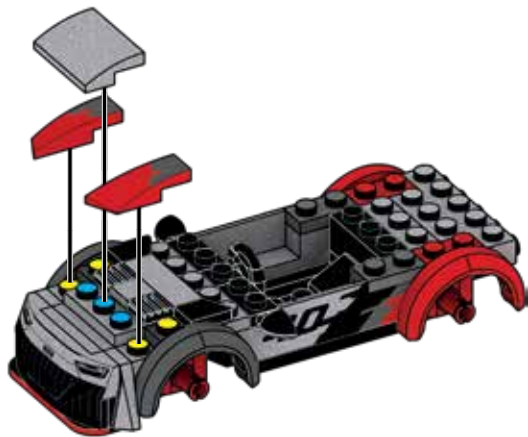

20



1x



1x



1x

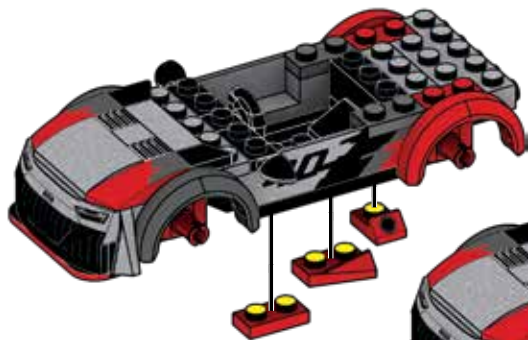

1

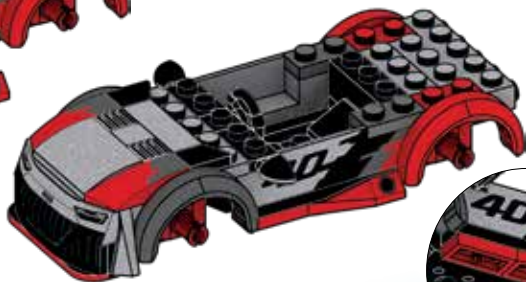

2



21



1x



1x



1x

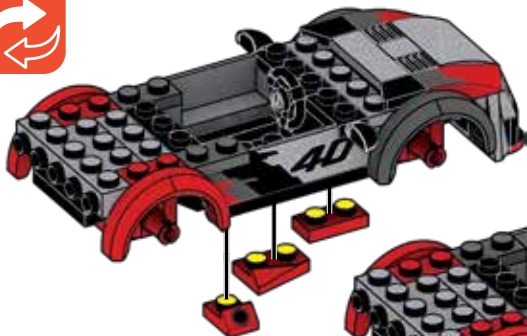

1

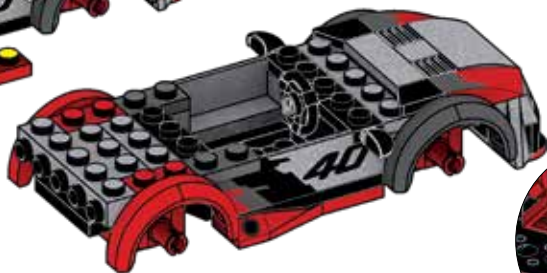

2

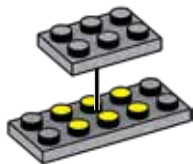

22*1x**1x**1x**1x***1****2****3**

23



24



3x

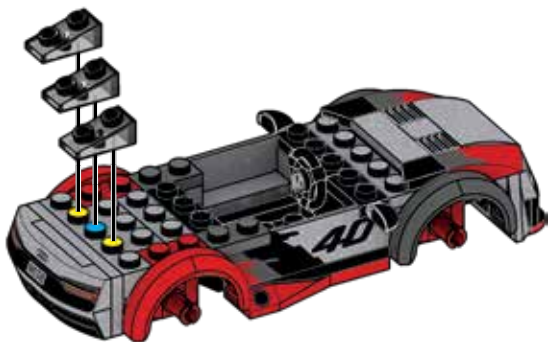

25



1x



1x

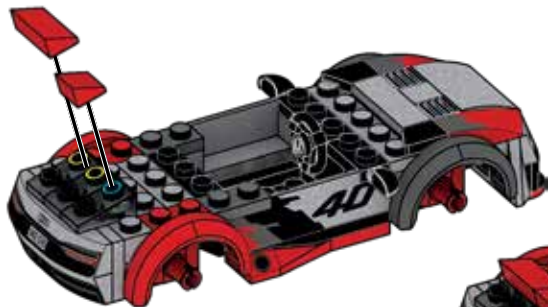

1

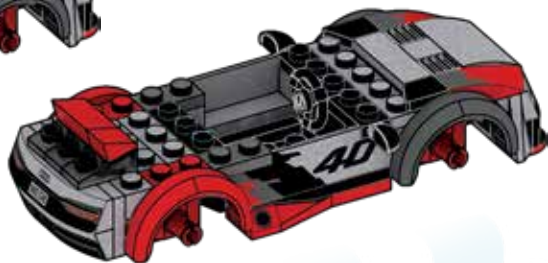

2

26



1x

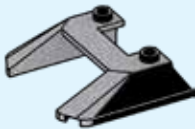

1x

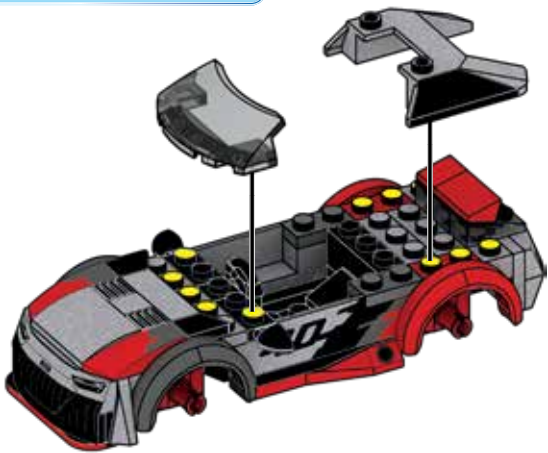

27



1x

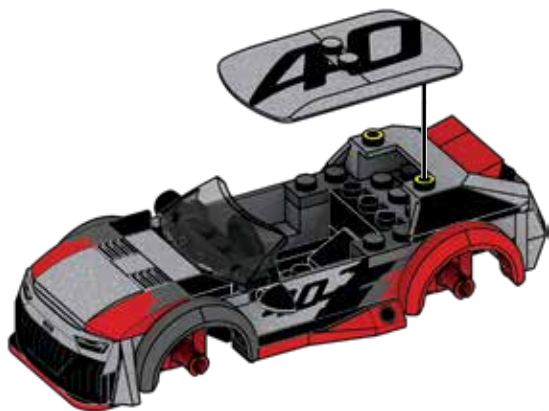

28



2x



2x

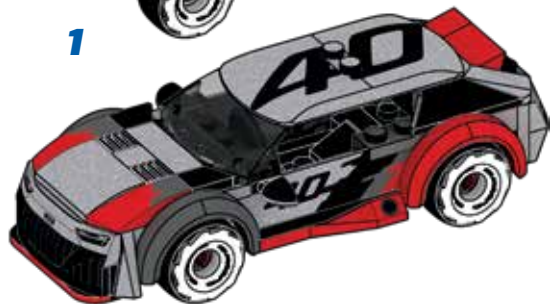
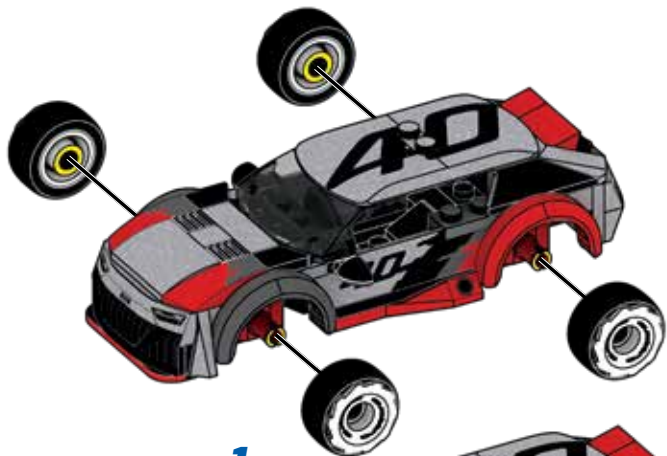



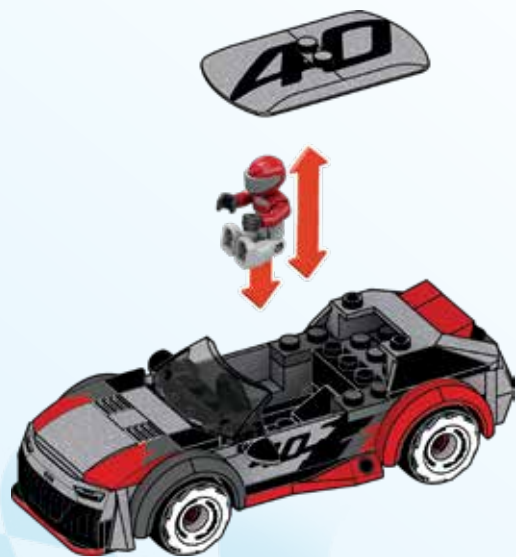

1

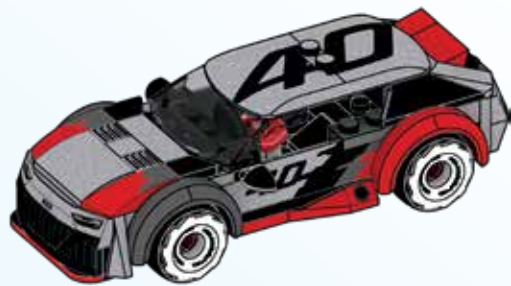

2

1x
AM07223APG



2x
AM79666F



1x
AM80546F



1x
AM74299F



1x
AM74300F



1x
AM17127AMC



2x
AS-HKF94-10



1x
AM18549AMC



1x
AM19061F



1x
AM81383F



1x
AM07590F



2x
AM09393BDG



2x
AM09393APG



2x
AM09393AMC



1x
AM15480AMC



1x
AM15480APG



1x
AM15481AMC



1x
AM15481APG



3x
AM80573AGY



1x
AM81382F



1x
AM81381F



2x
AS-HKF94-01



2x
AS-HKF94-02



1x
AM80966APG



1x
AM01314F



3x
AM01314APG



1x
AS-HKF94-07



1x
AS-HKF94-06



2x
AM16384F



3x
AM03772F



2x
AM03772APG



1x
AM81707APG



1x
AM81163APG



1x
AM81163F



2x
AM81787AMC



2x
AM81787BDG





1x
AM07475APG



1x
AS-HKF94-05



1x
AS-HKF94-04



1x
AS-HKF94-03



1x
AS-HKF94-12



1x
AS-HKF94-13



1x
AM80965APG



1x
AM80970APG



1x
AM80969APG



1x
AM81547AGY



2x
AM80971AMC



1x
AS-HKF94-08



1x
AS-HKF94-09

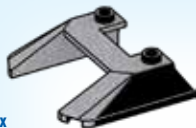

1x
AS-HKF94-11



1x
AS-HKF94-14



1x
AM80975F

Missing pieces? • Pièces manquantes?

¿Partes faltantes? • Perdeu peças?
Fehlen Teile? • Не хватает деталей?

support.megabrand.com



1x
FIG-HKF94-A



**WARNING:**

CHOKING HAZARD – Small parts.
Not for children under 3 years.

ATTENTION :
DANGER D'ÉTOUFFEMENT –
PETITS ÉLÉMENTS. NE
CONVIENT PAS AUX ENFANTS
DE MOINS DE 36 MOIS.

ATENÇÃO: NÃO INDICADO / NÃO RECOMENDÁVEL PARA CRIANÇAS MENORES DE 3 (TRÊS) ANOS POR CONTER PARTE(S) PEQUENA(S) QUE PODE(M) SER ENGOLIDA(S) OU ASPIRADA(S) PODENDO PROVOCAR ASFIXIA.

WARNING: Small parts, ATTENTION : PETITS ÉLÉMENTS, ACHTUNG:

Kleine Teile, AVVERTENZA: Piccole parti, WAARSCHUWING: Kleine onderdelen, ADVERTENCIA: PELIGRO DE ATRAGANTAMIENTO. Juguete no recomendado para menores de 3 años, porque contiene piezas pequeñas que podrían provocar asfixia en caso de ser ingeridas o inhaladas por el/la niño/a, VARNING: Små delar, VAROITUS: Pieniä osia, ADVARSEL: Små dele, ADVARSEL: Små deler, OSTRZEŻENIE: Małe części, UPOZORNĚNÍ: Malé části, UPOZORNENIE: Malé časti, FIGYELMEZTETÉS: Kis alkatrészek, ПРЕДУПРЕЖДЕНИЕ: Мелкие детали, ΠΡΟΕΙΔΟΠΟΙΗΣΗ: Μικρά κομμάτια, UYARI: Küçük parçalar.

警告:

のどにつまる危険 小さな部品が含まれています 3歳以下の子供には与えないで下さい。

警告! 不适合3岁以下儿童使用。内含小零件。

تحذير: قطع صغيرة.



Mattel Europa B.V., Gondel 1, 1186 MJ Amstelveen, Nederland. Mattel U.K. Limited, The Porter Building, 1 Brunel Way, Slough SL1 1FQ, UK. Mattel France, Parc de la Cerisaie, 1/3/5 allée des Fleurs, 94260 Fresnes Cedex, N° Cristal 0969 36 99 99 (Numéro non surtaxé) ou www.lesjouetsmattel.fr Mattel Belgium, Trade Mart, Atomiumsquare, Bogota 202 – B 275, 1020 Brussels. Gratis nummer België: 0800 – 16 936 - Gratis nummer Luxemburg: 800 – 22 784 - Gratis nummer Nederland: 0800 – 262 88 35. Deutschland : Mattel GmbH, Solmsstraße 83, D-60486 Frankfurt am Main. Schweiz: Mattel AG, Kirchstrasse 24, CH-3097 Liebefeld. Österreich: Mattel Ges.m.b.H., Campus 21, Liebermannstraße A01 404, A- 2345 Brunn/Gebirge. Mattel Italy Srl, Via Turati 4, 20121 Milano, Italy. Servizio assistenza clienti: Customerservizioitalia@mattel.com - Numero verde 800 11 37 11. Mattel España, S.A, Aribau 200 pl. 9, 08036 Barcelona. c.service.spain@mattel.com Tel.: +34 933 06 79 00 <http://www.service.mattel.com/es>. Hong Kong: Kids Kingdom Limited, Room 1908-9, Gala Place, 56 Dundas Street, Mongkok, Kowloon, Hong Kong. Customer Care line: (852)2782-0766. Taiwan: Chickabiddy Company Limited, 5/F, No. 186, Section 4, Nanjing East Road, Taipei 10595, Taiwan. Customer Care line: (02)2578-1188. Mainland China: Mattel Barbie (Shanghai) Trading Co., Ltd. Units 4701-4711, 47F, 2 Grand Gateway, 3 Hong Qiao Road, Shanghai, 200030, P.R.C. Customer Care line: 400-819-8658. Diimport y Diedarkan Oleh: Mattel Continental Asia Sdn Bhd. Level 19, Tower 3, Avenue 7, No. 8 Jalan Kerinci, Bangsar South, 59200 Kuala Lumpur, Malaysia. Mattel South Africa (PTY) LTD, Office 102 B, 30 Melrose Boulevard, Johannesburg 2196. Dystrybutor: Mattel Poland Sp. z o.o., Warsaw Trade Tower 34 p., ul. Chłodna 51, 00-867 Warszawa. Mattel Australia Pty. Ltd., 658 Church St., Richmond, Victoria, 3121. Consumer Advisory Service - 1300 135 312. Mattel AEBE, Εθνόγγυου Μακροπίου 1, Κτήριο Κ-2, ΚΤ 17561, Πολιάοι Φόληρο. Mattel Oyuncakçılık Tic. Ltd. Şti. İcerenköy Mah., Umut Sokak No: 10 - 12, Quick Tower kat:2 İçkapı no:15 Ataşehir 34752, İstanbul, Türkiye. Tel: 0216 570 75 00. Импортёр/Уполномоченная организация: ООО "МАТТЕЛ" Российская Федерация, 105120 Москва, 2-й Сыромятнинский переулок 1; +7 495 287 79 39. Mattel Czech Republic s.r.o., The Forum, Václavské nám. 19, 11000 Praha1, Mattel, 333 Continental Boulevard, El Segundo, CA 90245, USA. Consumer Services: 1-800-465-MEGA (6342). Mattel Canada Inc., Mississauga, Ontario L5R 3W2. Consumer Services: You may call us free at / Composez sans frais le 1-800-524-8697. Importado y distribuido por Mattel de México, S.A. de C.V., Miguel de Cervantes Saavedra No. 193, Pisos 10 y 11, Col. Granada, Alcaldía Miguel Hidalgo, C.P. 11520, México, Ciudad de México. R.F.C. MME-920701-NB3. Tels.: 59-05-51-00 Ext. 5206 ó 01-800-463-59-89. Mattel Chile, S.A., Avenida América Vespucio 501-B, Quilicura, Santiago, Tel.: 1230-020-6213. Servicio al consumidor Venezuela: Tel.: 0-800-100-9123. Mattel Argentina, S.A., Av. Libertador 1000, Piso 11 – Oficinas 109 y 111, Vicente López – Prov. Buenos Aires. Tel.: 0800-666-3373. Mattel Colombia, S.A., Calle 123#7-07 P5, Bogotá, Tel.: 01-800-710-2069. Mattel Perú, S.A., Av. Juan de Arona # 151, Centro Empresarial Juan de Arona, Torre C, Piso 7, Oficina 704, San Isidro, Lima 27, Perú. RUC: 20425853865. Reg. Importador: 02350-12-JUE-DIGESA. Tel: 0800-54744. E-mail latinoamerica.servicio.clientes@mattel.com. Mattel do Brasil Ltda. - CNPJ : 54.558.002/0001-20 - Rua Verbo Divino, 1488 - 2º Andar - 04719-904 - Chácara Santo Antônio - São Paulo - SP - Brasil. Serviço de Atendimento ao Consumidor: fone 0800 575 0780. E-mail: sac.mattel@doabrazil.com

BUILD YOUR WAY BY COMBINING MEGA™ HOT WHEELS™ SETS CRÉEZ VOTRE UNIVERSE EN ASSOCIANT LES COFFRETS HOT WHEELS™ MEGA™



HHL96

HKF93

HHL95

HKF94

Construye el reto combinando los conjuntos de Hot Wheels® de MEGA™
 Construa o desafio combinando os conjuntos MEGA™ Hot Wheels®
 Ergane Streeken x durch das Kombinieren von MEGA Hot Wheels Sets
 Стройте по-своему, объединяя наборы MEGA™ Hot Wheels®

Set(s) sold separately and subject to availability. / Ensemble(s) vendu(s) séparément. Certains produits peuvent ne pas être commercialisés. / Se vende(n) por separado y está(n) sujeto(s) a disponibilidad. / Conjunto(s) em separado e sujeito(s) à disponibilidade. / Set in vendita separatamente, secondo disponibilità. / Das/Die Set(s) sind separat erhältlich. / Zestaw(y) sprzedawany(e) oddzielnie w zależności od dostępności. / Set(s) apart verkrijgbaar en afhankelijk van beschikbaarheid. / Набор(-ы) продаются отдельно, при наличии. / Sæt sælges separat og så længe lager haves. / Seten säljs separat så länge lagret räcker. / Settet/settene selges separat så langt lageret rekker. / Pakkaus/pakkausset myydään erikseen, saatavuus voi vaihdella. / Το(α) σετ πωλούνται ξεχωριστά και ανάλογα με τη διαθεσιμότητα. / Setler ayrı olarak satılır ve stoklarına sınırlıdır. / Set (sety) se prodává (prodávají) samostatně dle aktuální nabídky. / Súprava/-y sa predáva(jú) samostatne podľa dostupnosti. / A készlet(ek) külön kapható(k), az elérhetőség változhat. / セット商品は別売りになります。在庫状況は別途ご確認をお願いします。
 تباع المجموعة أو المجموعات على حدة وتخضع لتوافرها.
 每套单独发售，按供货情况决定。

Mattel Canada Inc. Mississauga, Ontario L5R 3W2.
 MADE IN CHINA. FABRIQUÉ EN CHINE. FABRICADO NA CHINA. HECHO EN CHINA.
 ИЗГОТОВЛЕНО В КИТАЕ. ЧИՆԴԵ ՕՐԵՒԷԼՄԻՏՐ. صنع في الصين

HOT WHEELS®, MATTEL and associated trademarks and trade dress are owned by, and used under license from Mattel. ©2022 Mattel.

©2022 MEGA Brands &™ MEGA Brands.
 Printed in China / Imprimé en Chine

AD-HKF94-01B



Trademarks, design patents and copyrights are used with the approval of the owner AUDI AG.



1186 MJ, 1, NL

ⓅD714,887

