



WARNING:
CHOKING HAZARD – Small parts.
Not for children under 3 years.

ATTENTION :
DANGER D'ÉTOUFFEMENT –
Petits éléments. Ne convient pas
aux enfants de moins de 36 mois.

4+

COLORS AND DECORATIONS MAY VARY. • LOS COLORES Y LAS DECORACIONES PUEDEN VARIAR. • LES COULEURS ET LES MOTIFS PEUVENT VARIER. • AS CORES E AS DECORAÇÕES PODEM VARIAR.

TWO VEHICLES INCLUDED. ADDITIONAL VEHICLES SOLD SEPARATELY. NOT FOR USE WITH SOME HOT WHEELS® VEHICLES. • INCLUYE DOS VEHÍCULOS. LOS VEHÍCULOS ADICIONALES SE VENDEN POR SEPARADO. NO COMPATIBLE CON ALGUNOS VEHÍCULOS HOT WHEELS. • DEUX VEHICULES INCLUS. AUTRES VEHICULES VENDUS SÉPARÉMENT. NON COMPATIBLE AVEC CERTAINS VEHICULES HOT WHEELS. • DOIS VEICULOS INCLUIDOS. VEÍCULOS ADICIONAIS VENDIDOS SEPARADAMENTE. NÃO É COMPATÍVEL COM ALGUNS VEÍCULOS HOT WHEELS.

PLEASE KEEP THESE INSTRUCTIONS FOR FUTURE REFERENCE AS THEY CONTAIN IMPORTANT INFORMATION. • LEE Y GUARDA ESTAS INSTRUCCIONES PARA FUTURA REFERENCIA, YA QUE CONTIENEN INFORMACIÓN IMPORTANTE ACERCA DE ESTE PRODUCTO. • CONSERVER CE MODE D'EMPLOI POUR S'Y RÉFÉRER EN CAS DE BESOIN, CAR IL CONTIENT DES INFORMATIONS IMPORTANTES. • POR FAVOR, GUARDE ESTAS INSTRUÇÕES PARA FUTURA REFERÊNCIA, POIS CONTÉM INFORMAÇÕES IMPORTANTES.

WARNING: Not suitable for children under 36 months. Small parts.

ADVERTENCIA: PELIGRO DE ATRAGANTAMIENTO. Juguete no recomendado para menores de 3 años, porque contiene piezas pequeñas que podrían provocar asfixia en caso de ser ingeridas o inhaladas por el/la niño/a.

? service.mattel.com

ATENÇÃO: NÃO INDICADO / NÃO RECOMENDÁVEL PARA CRIANÇAS MENORES DE 3 (TRÊS) ANOS POR CONTER PARTE(S) PEQUENA(S) QUE PODE(M) SER ENGOLIDA(S) OU ASPIRADA(S) PODENDO PROVOCAR ASFIXIA.

ATTENTION : NE CONVIENT PAS AUX ENFANTS DE MOINS DE 36 MOIS - PETITS ÉLÉMENTS.



ASSEMBLY INSTRUCTIONS
INSTRUCCIONES DE MONTAJE
INSTRUÇÕES D'ASSEMBLAGE
INSTRUÇÕES DE MONTAGEM



ADULTS, FIND OUT MORE:
ADULTOS, ESCANEEN PARA OBTENER
MÁS INFORMACIÓN:
ADULTES, POUR EN SAVOIR PLUS :
INFORMAÇÕES AOS PAIS:

ADULT ASSEMBLY REQUIRED.
REQUIRE MONTAJE POR UN ADULTO.
ASSEMBLAGE PAR UN ADULTE REQUIS.
REQUER MONTAGEM POR UM ADULTO.

**INSTRUCTIONS • INSTRUCCIONES
MODE D'EMPLOI • INSTRUÇÕES**

©2023 Mattel. Mattel, Inc., 636 Girard Avenue, East Aurora, NY 14052, U.S.A. Consumer Services 1-800-524-8697. Mattel Canada Inc., Mississauga, Ontario L5R 3W2. You may call us free at / Composez sans frais le 1-800-524-8697. Mattel Europa B.V., Gondel 1, 1186 MJ Amstelveen, Nederland. Mattel U.K. Limited, The Porter Building, 1 Brunel Way, Slough SL1 1FQ, UK. Mattel Australia Pty. Ltd., 658 Church St., Richmond, Victoria, 3121. Consumer Advisory Service - 1300 135 312. Chinese mainland: Mattel Barbie (Shanghai). Trading Co., Ltd. Room 2005, 20th Floor, 899 Ruining Road, Xuhui District, Shanghai, 200232, P.R.C. Customer Care Line: 400-819-8658. Hong Kong SAR: Kids Kingdom Limited, Room 1908-9, Gala Place, 56 Dundas Street, Mongkok, Kowloon, Hong Kong, P.R.C. Customer Care Line: (852)2782-0766. Taiwan region: CHICKABIDDY CO., LTD, F5, No. 186, Sec. 4, Nanjing E. Rd., Taipei 10595, Taiwan region. Customer Care Line: 0800 001 256. Diimport & Diedarkan Oleh: Mattel Continental Asia Sdn Bhd, Level 19, Tower 3, Avenue 7, No. 8 Jalan Kerinchi, Bangsar South, 59200 Kuala Lumpur, Malaysia. Mattel South Africa (PTY) LTD, Office 10213, 30 Melrose Boulevard, Johannesburg 2196. Importado y distribuido por Mattel de México, S.A. de C.V., Miguel de Cervantes Saavedra No. 193, Pisos 10 y 11, Col. Granada, Alcaldía Miguel Hidalgo, C.P. 11520, México, Ciudad de México. R.F.C. MME-920701-NB3. Tels: 59-05-51-00 Ext. 5206 601-800-463-59-89. Mattel Chile S.A., Pdtte. Riesco 5561, Of. 203-204 PS2, Las Condes, Santiago. Servicio al consumidor Venezuela: Tel.: 0-800-100-9123. Mattel Argentina, S.A., Av. Libertador 1000, Piso 11 – Oficinas 109 y 111, Vicente López – Prov. Buenos Aires. Tel.: 0800-666-3373. Mattel Colombia, S.A., Calle 123#7-07 P.5, Bogotá. Mattel Perú, S.A., Av. Juan de Arona # 151, Centro Empresarial Juan de Arona, Torre C, Piso 7, Oficina 704, San Isidro, Lima 27, Perú. RUC: 20425853865. Reg. Importador: 02350-12-JUE-DIGESA. Tel.: 0800-54744. E-mail Latinoamérica: Servicio.Clientes@Mattel.com. Distribuido por : Mattel do Brasil Ltda.- CNPJ : 54.558.002/0001-20 - Rua Verbo Divino, 1488 - 2º. Andar - 04719-904 - Chácara Santo Antônio - São Paulo - SP - Brasil. Serviço de Atendimento ao Consumidor: Contato: <https://faleconosco.mattel.com.br/Contato>. E-mail: sac.matteldobrazil@mattel.com. Mattel France, Parc de la Cerisaie, 1/3/5 allée des Fleurs, 94260 Fresnes Cedex. N° Cristal 0969 36 99 99 (Numéro non surtaxé) ou www.lesjouetsmattel.fr. Mattel España, S. A, Aribau 200 pl. 9, 08036 Barcelona. cservice.spain@mattel.com Tel.: +34 933 06 79 00 <http://www.service.mattel.com.es>.

HKX48-4B7062 MO
1103084010-4L8-R1

HOTWHEELS.COM



CONTENTS • CONTENIDO • CONTENU • CONTEÚDO	3	
APPLY LABELS • PEGA LAS CALCOMANÍAS • APOSER LES AUTOCOLLANTS • COLAR ADESIVOS	4	
ASSEMBLY • ENSAMBLAJE • ASSEMBLAGE • MONTAGEM	5	
TO PLAY PARA JUGAR PLACE AU JEU COMO BRINCAR	MOVING LAUNCHER & CAR LIFT • LANZADOR MÓVIL Y ELEVADOR DE VEHÍCULO DÉPLACEMENT DU LANCEUR ET DE L'ASCENSEUR À VÉHICULES • LANÇADOR MÓVEL E ELEVADOR DE CARROS	21
	LEVEL 1 • PISO 1 • NIVEAU 1 • NÍVEL 1	22
	LEVEL 2 • PISO 2 • NIVEAU 2 • NÍVEL 2	24
	LEVEL 3 • PISO 3 • NIVEAU 3 • NÍVEL 3	26
	DRAGON ON TOP • DRAGÓN EN LA PARTE SUPERIOR DRAGON AU SOMMET • DRAGÃO NA PARTE DE CIMA	28
MORE WAYS TO PLAY • MÁS MANERAS DE JUGAR AUTRES FAÇONS DE JOUER • OUTRAS MANEIRAS DE BRINCAR	30	
PERFORMANCE TIPS • CONSEJOS DE RENDIMIENTO CONSEILS D'UTILISATION • DICAS DE DESEMPENHO	31	

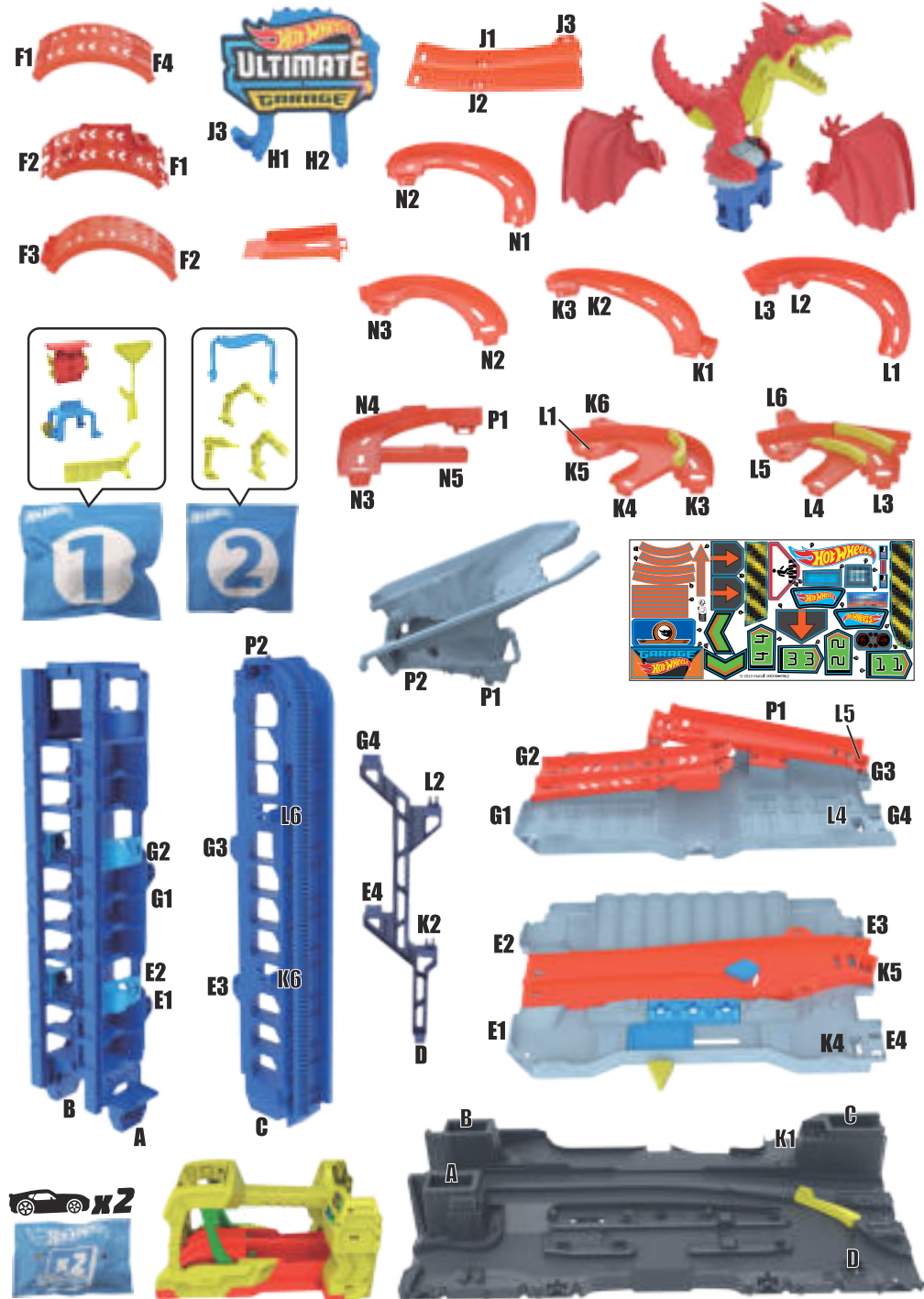

KEY: • CONSEJO: • LÉGENDE: • CHAVE:



SNAP TO CONNECT! • ENCAJA PARA CONECTAR!
ENCLANCHER POUR CONNECTER!
ENCAIXE PARA CONECTAR!



ASSEMBLY COMPLETED!
¡ENSAMBLAJE COMPLETADO!
ASSEMBLAGE TERMINÉ!
MONTAGEM CONCLUÍDA!



ALIGN MOLDED LETTERS ON PARTS.
ALINEA LAS LETRAS MOLDEADAS EN LAS PIEZAS.
ALIGNER LES LETTRES MOULÉES INDIQUÉES SUR LES PIÈCES.
ALINHE AS LETRAS MOLDADAS NAS PEÇAS.

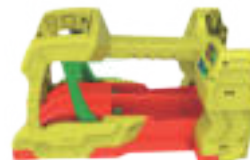

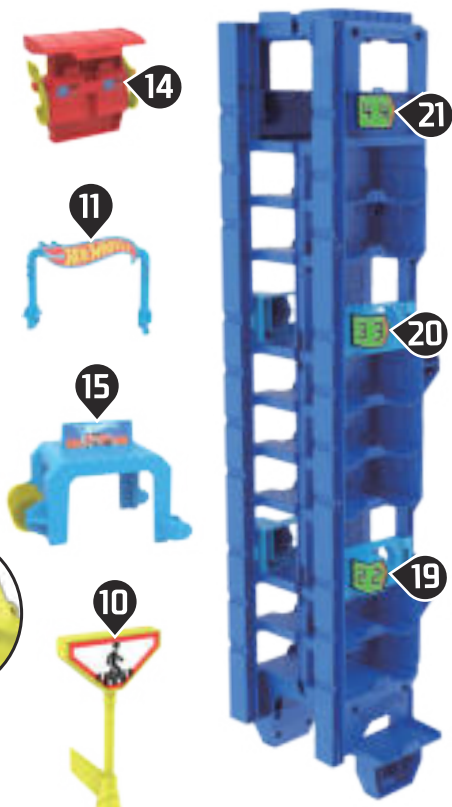
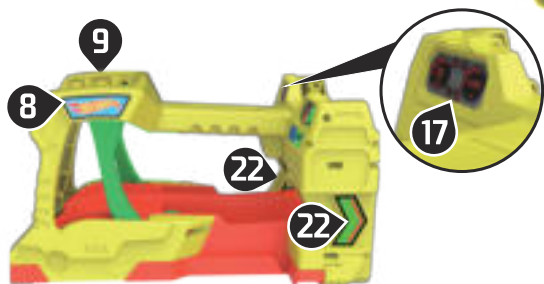
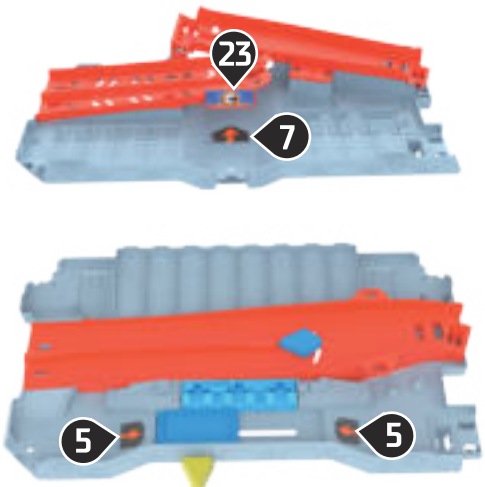
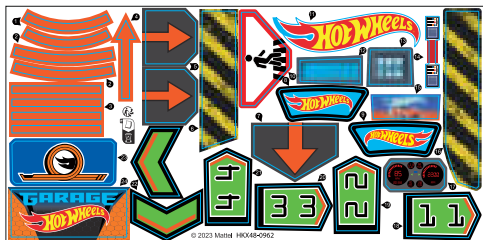

1

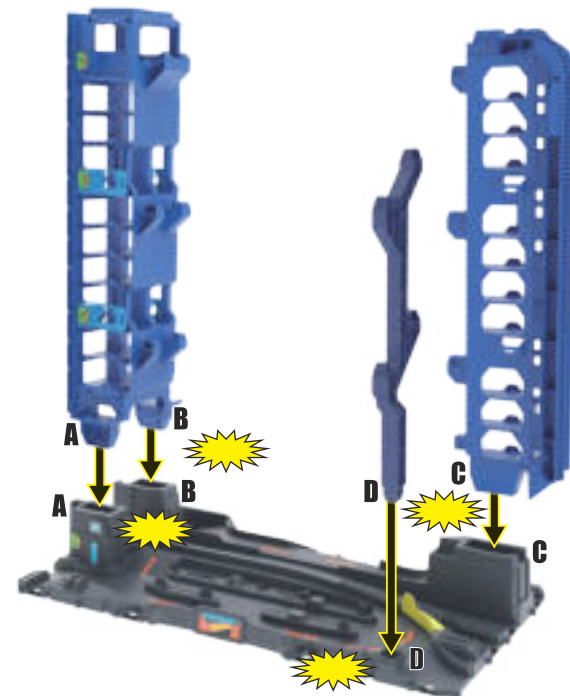

2

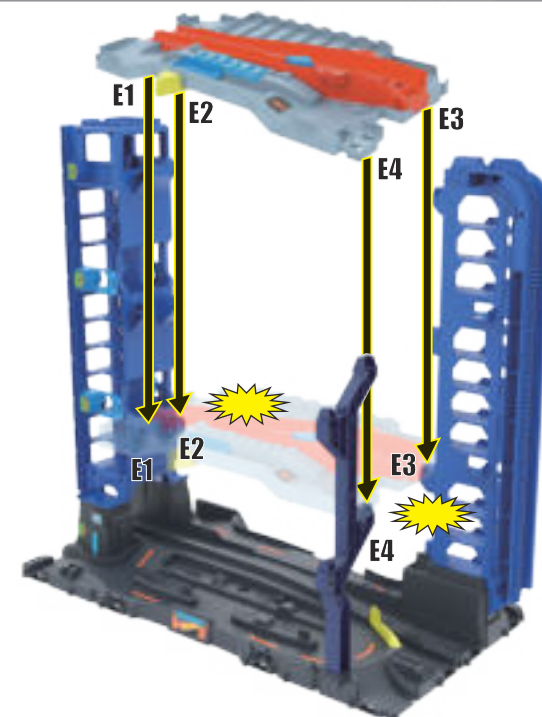

ASSEMBLY • ENSEMBLAJE
 ASSEMBLAGE • MONTAGEM

3

PART YOU NEED: • PIEZA NECESARIA:
 PIÉCE NÉCESSAIRE: • PEÇAS QUE VOCÊ PRECISA:



J1 J3
 J2

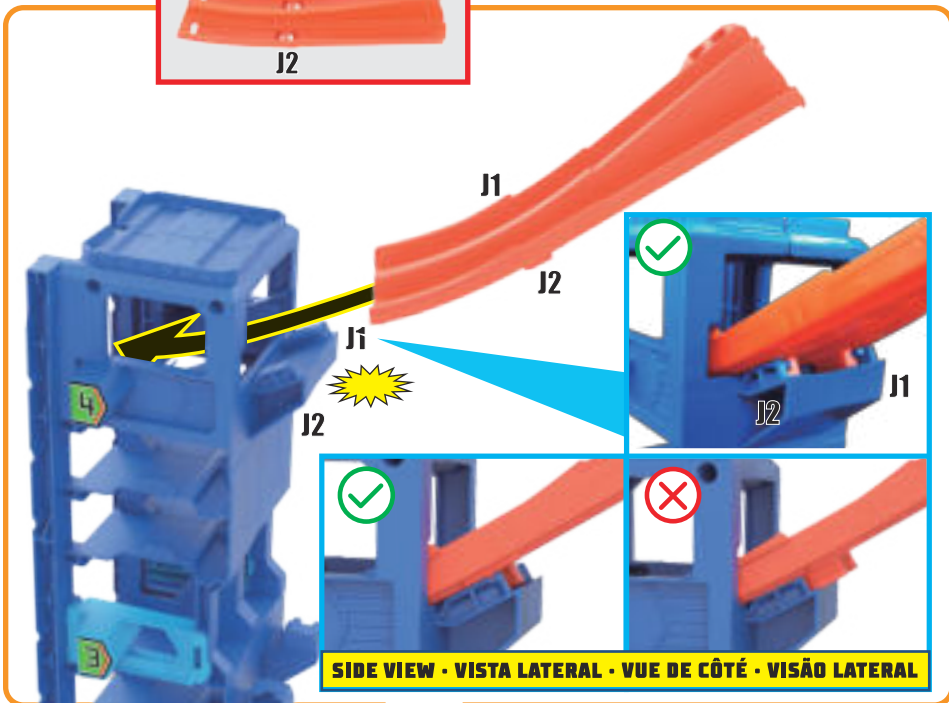

SIDE VIEW • VISTA LATERAL • VUE DE CÔTÉ • VISÃO LATERAL

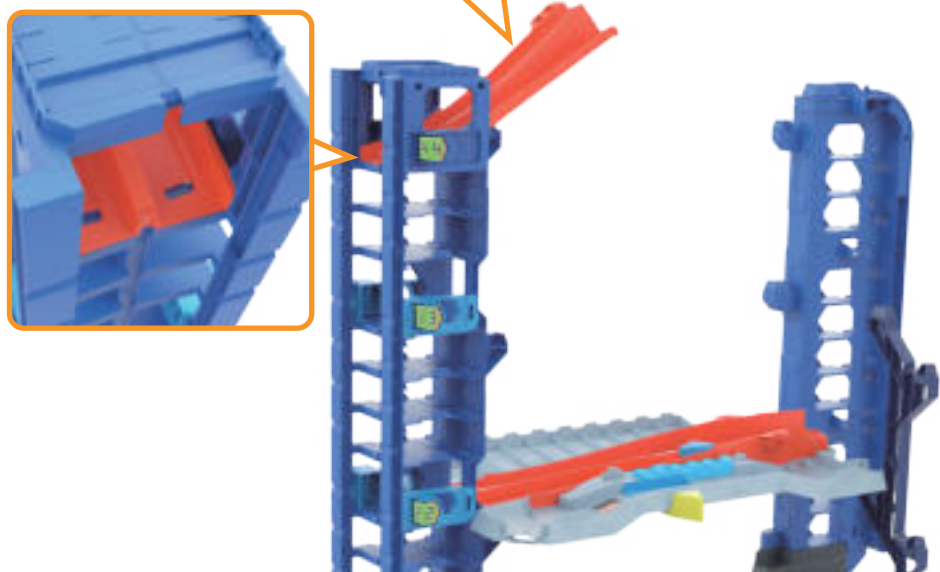

4

PARTS YOU NEED: • PIEZAS NECESARIAS:
 PIÉCES NÉCESSAIRES: • PEÇAS QUE VOCÊ PRECISA:



F2 F1 J3 H1 H2

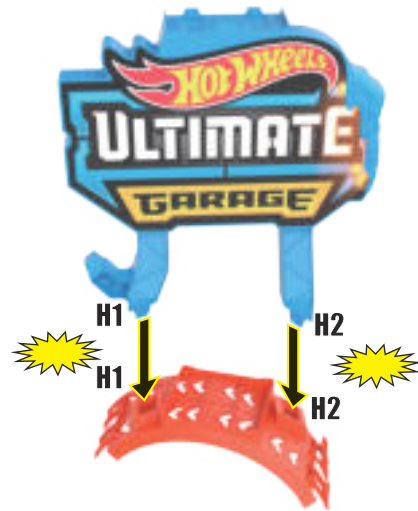

5

PARTS YOU NEED: • PIEZAS NECESARIAS:
 PIÉCES NÉCESSAIRES: • PEÇAS QUE VOCÊ PRECISA:



F3 F2 F1 F4



6

PART YOU NEED: - PIEZA NECESARIA:
 PIÉCE NÉCESSAIRE: - PEÇA QUE VOCÊ PRECISA:

G2 F3 G3
 F4
 G1 G4

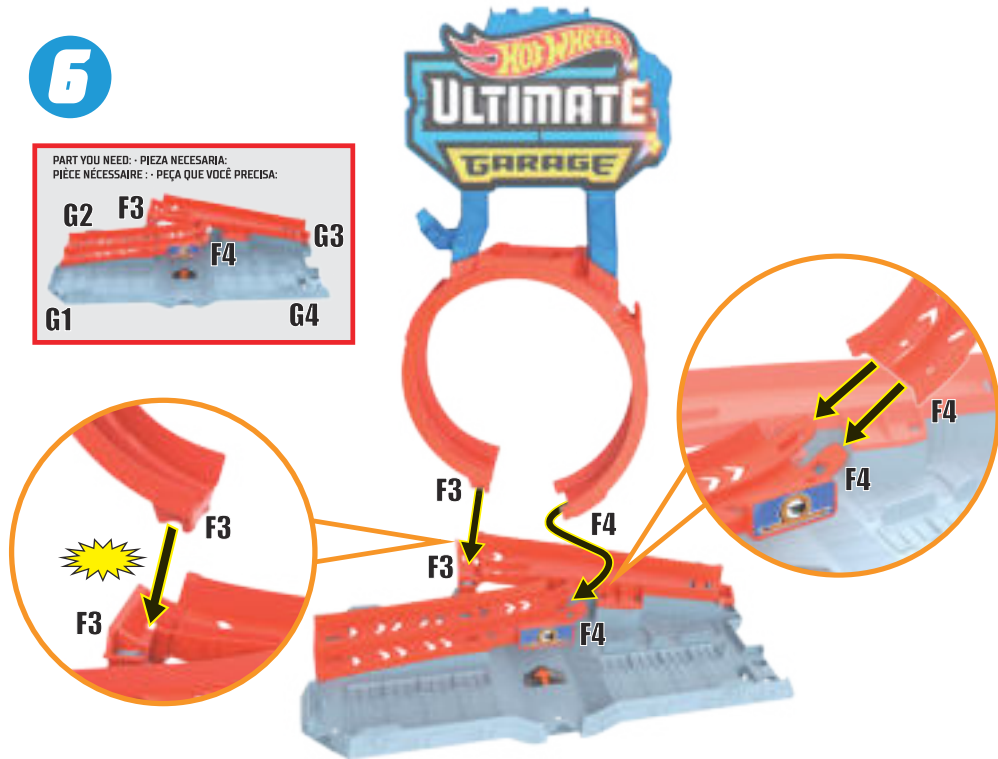

8

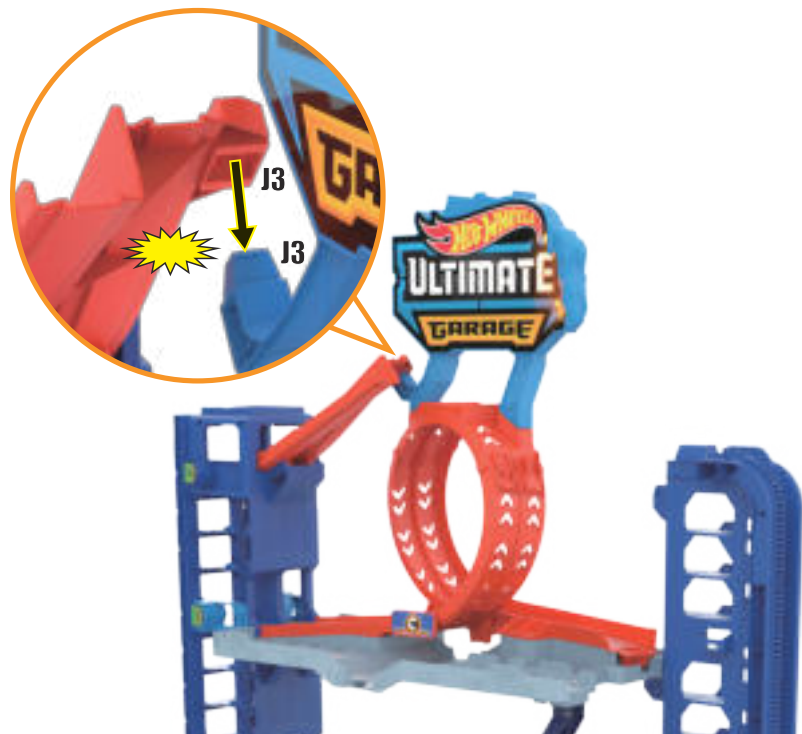

7

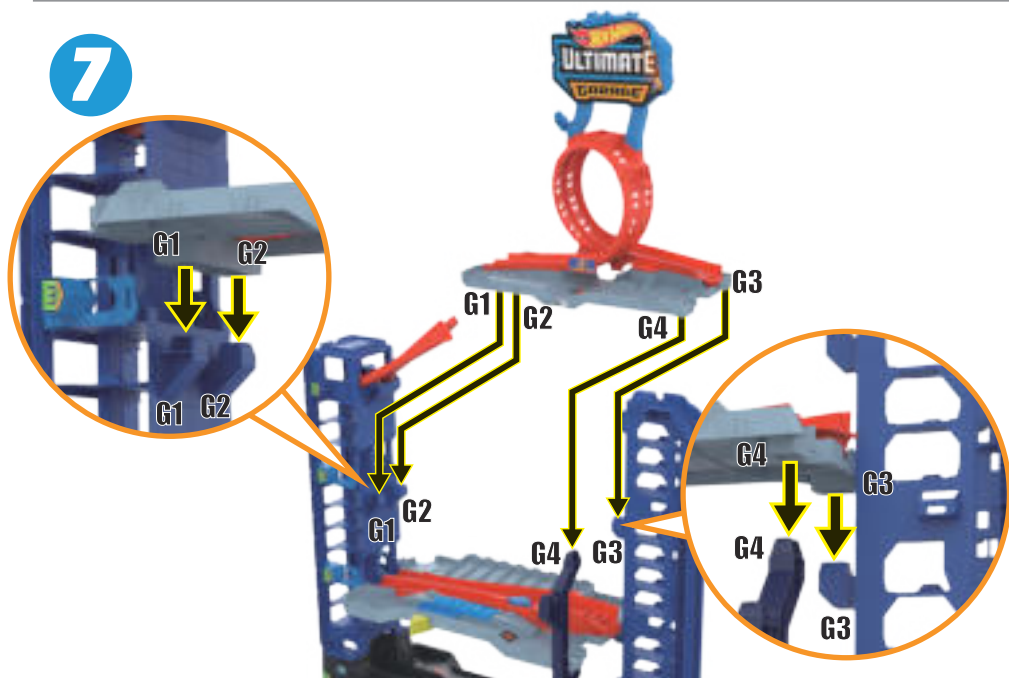

9

PART YOU NEED: - PIEZA NECESARIA:
 PIÉCE NÉCESSAIRE: - PEÇA QUE VOCÊ PRECISA:

K3 K2
 K1

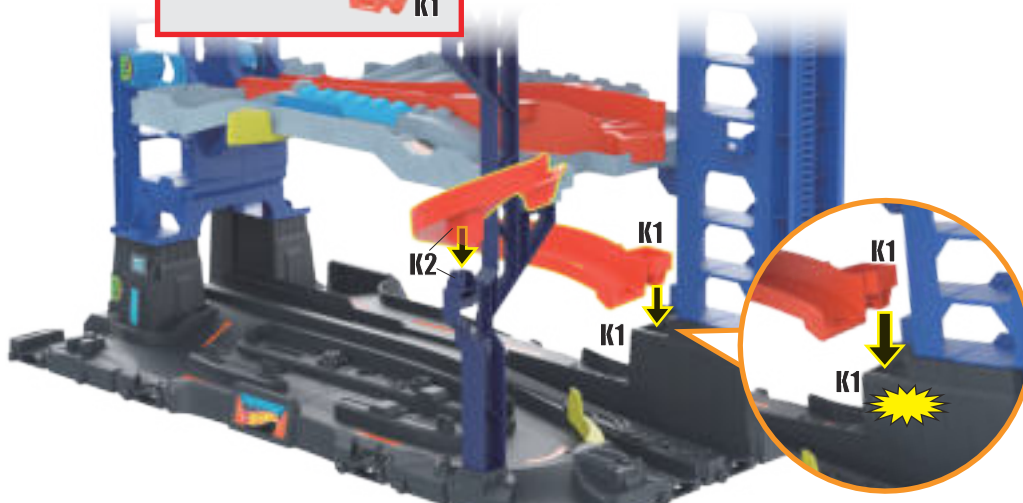

10

PART YOU NEED: - PIEZA NECESARIA:
 PIÈCE NÉCESSAIRE: - PEÇA QUE VOCÊ PRECISA:

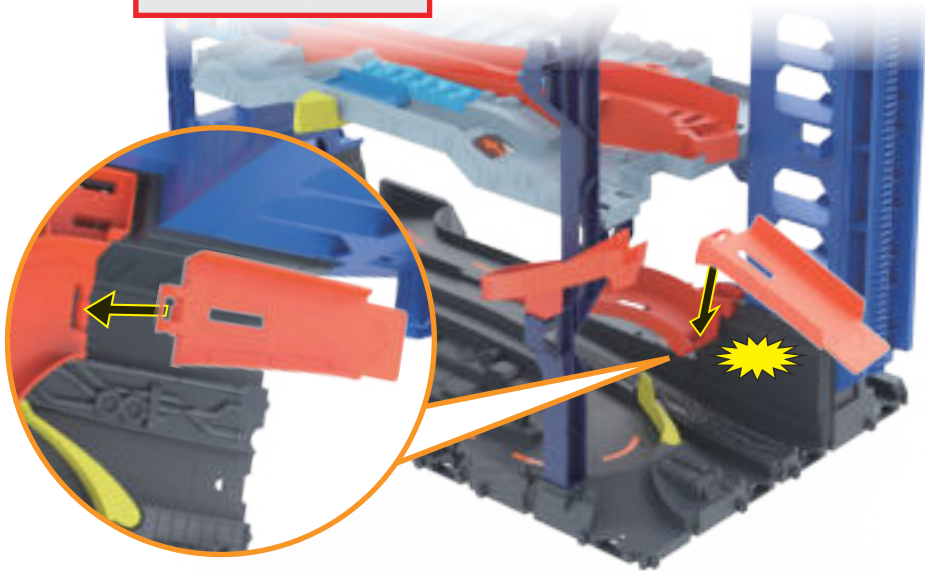

12

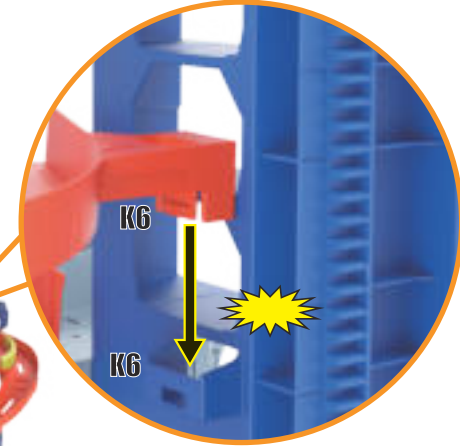

11

PART YOU NEED: - PIEZA NECESARIA:
 PIÈCE NÉCESSAIRE: - PEÇA QUE VOCÊ PRECISA:

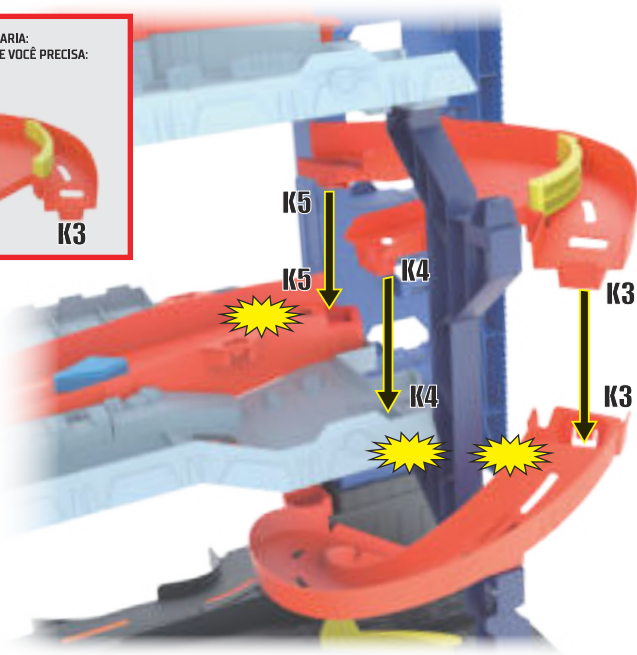
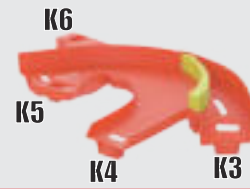

13

PART YOU NEED: - PIEZA NECESARIA:
 PIÈCE NÉCESSAIRE: - PEÇA QUE VOCÊ PRECISA:

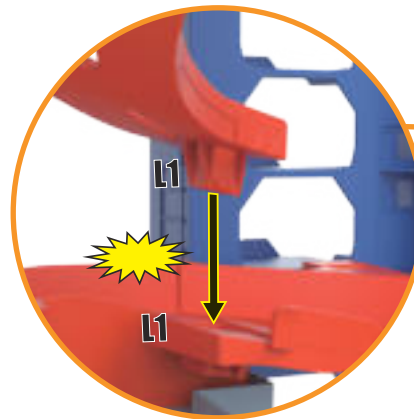
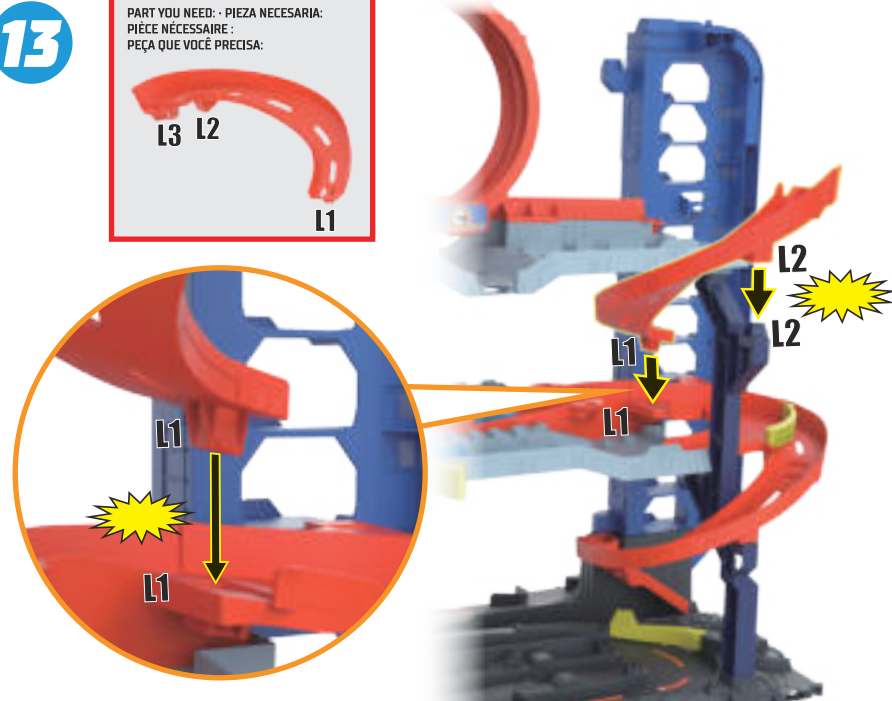

14

PART YOU NEED: - PIEZA NECESARIA:
 PIÈCE NÉCESSAIRE:
 PEÇA QUE VOCÊ PRECISA:

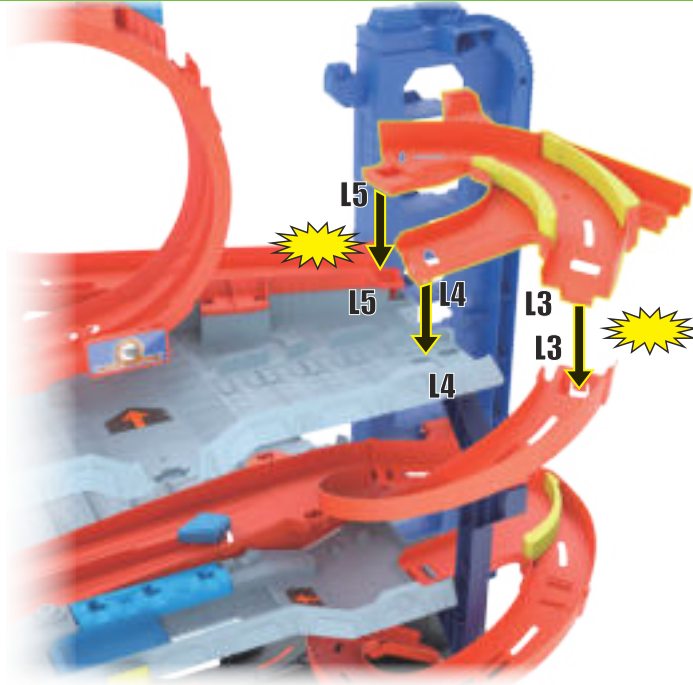
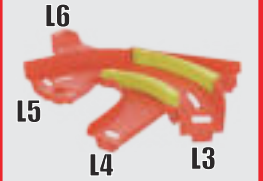

16

PART YOU NEED: - PIEZA NECESARIA:
 PIÈCE NÉCESSAIRE:
 PEÇA QUE VOCÊ PRECISA:

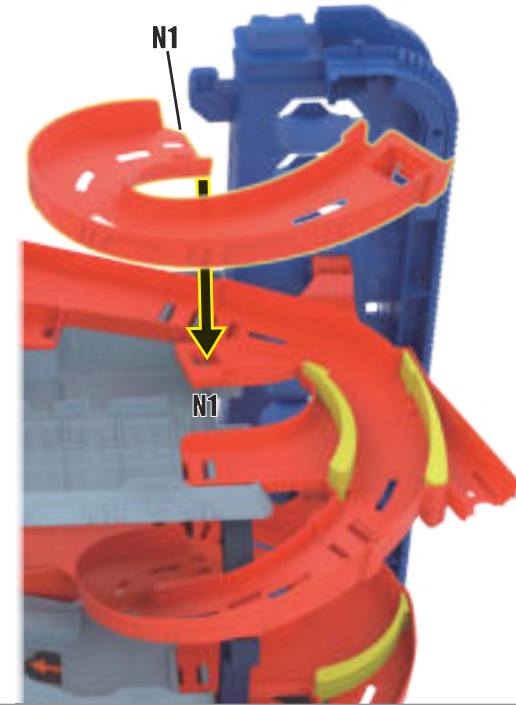

15

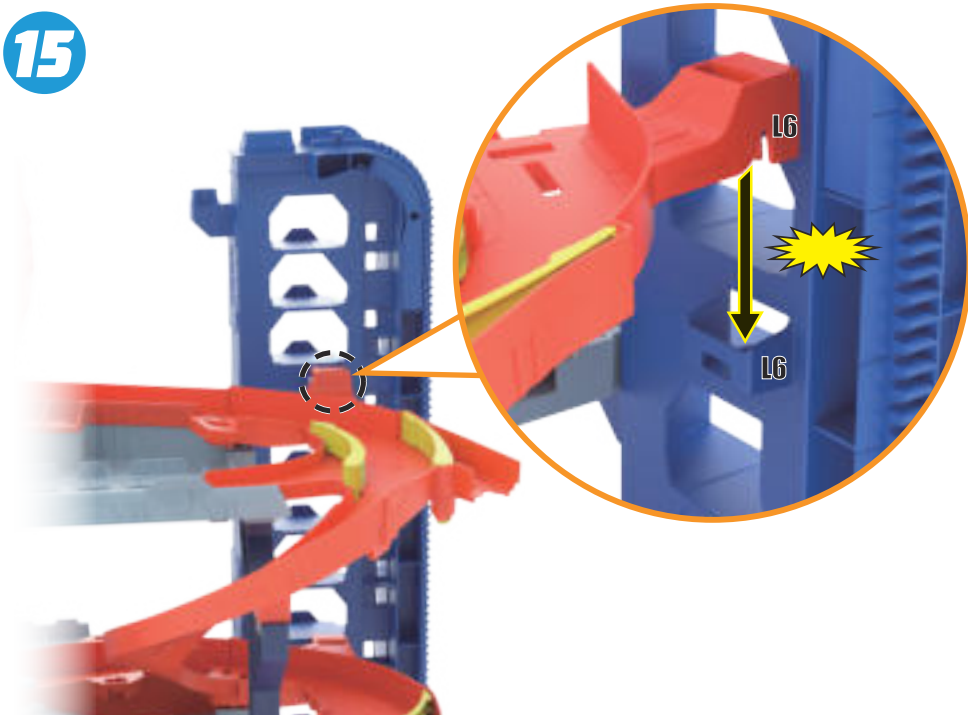

17

PART YOU NEED: - PIEZA NECESARIA:
 PIÈCE NÉCESSAIRE:
 PEÇA QUE VOCÊ PRECISA:

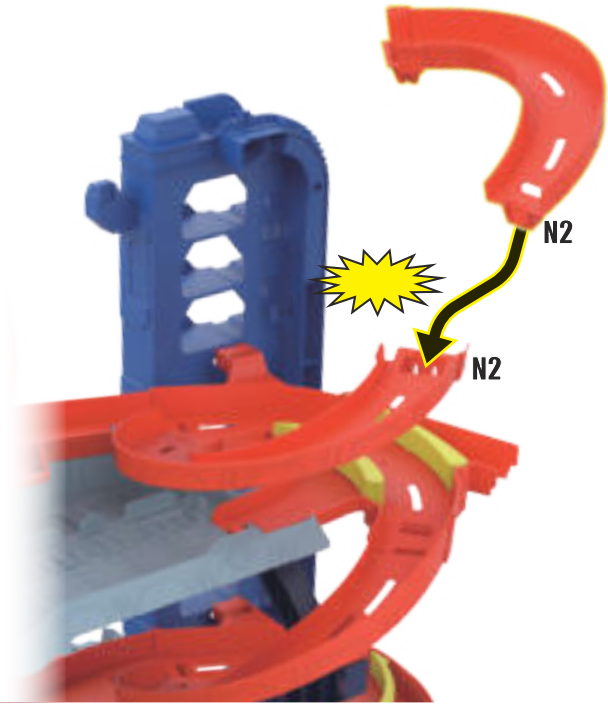

18

PART YOU NEED: - PIEZA NECESARIA:
 PIÉCE NÉCESSAIRE:
 PEÇA QUE VOCÊ PRECISA:

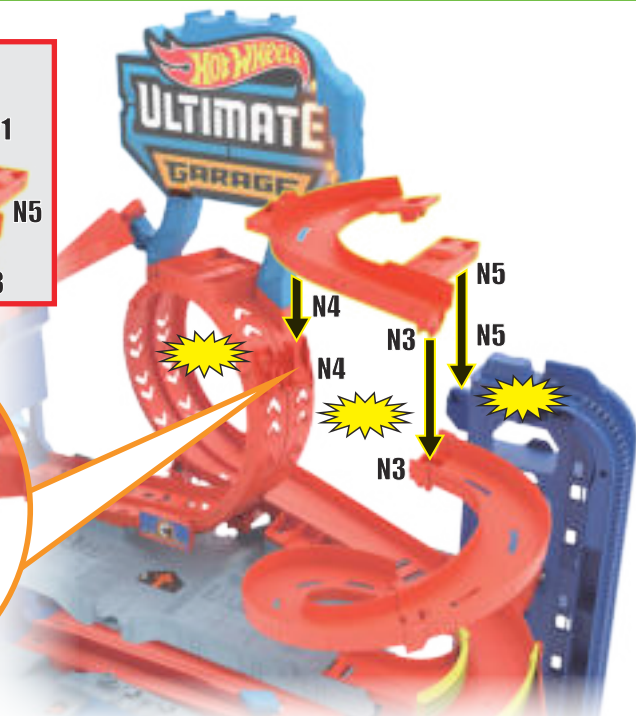
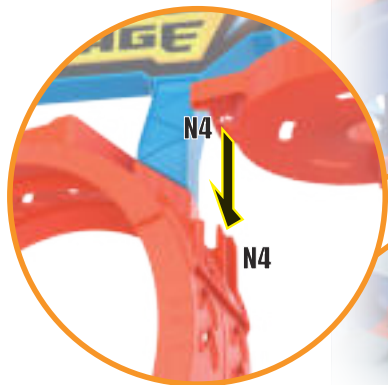

19

PART YOU NEED: - PIEZA NECESARIA:
 PIÉCE NÉCESSAIRE:
 PEÇA QUE VOCÊ PRECISA:

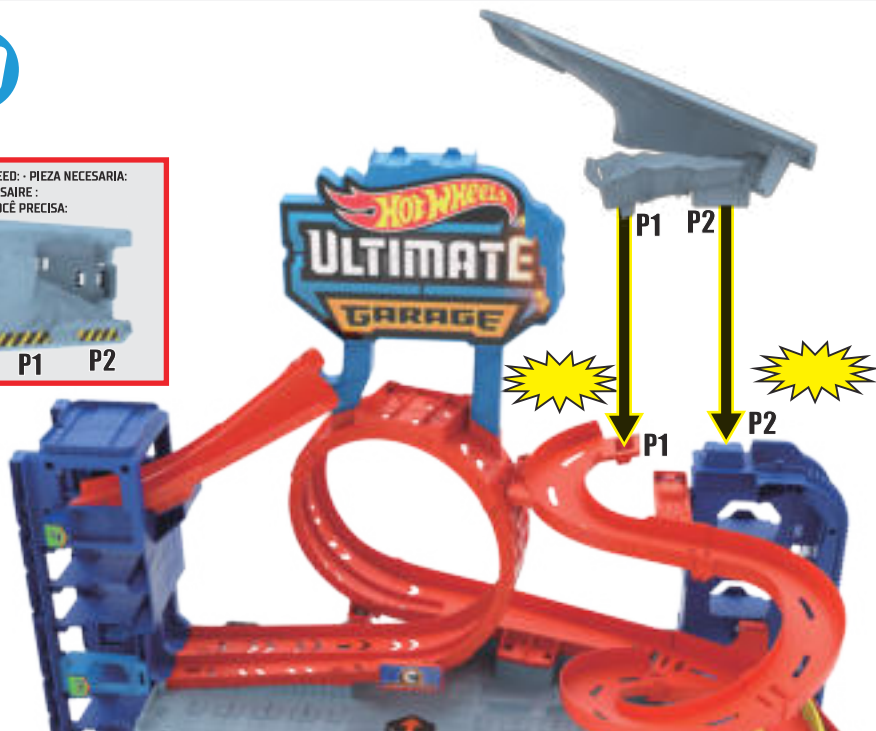

20

PART YOU NEED: - PIEZA NECESARIA:
 PIÉCE NÉCESSAIRE:
 PEÇA QUE VOCÊ PRECISA:

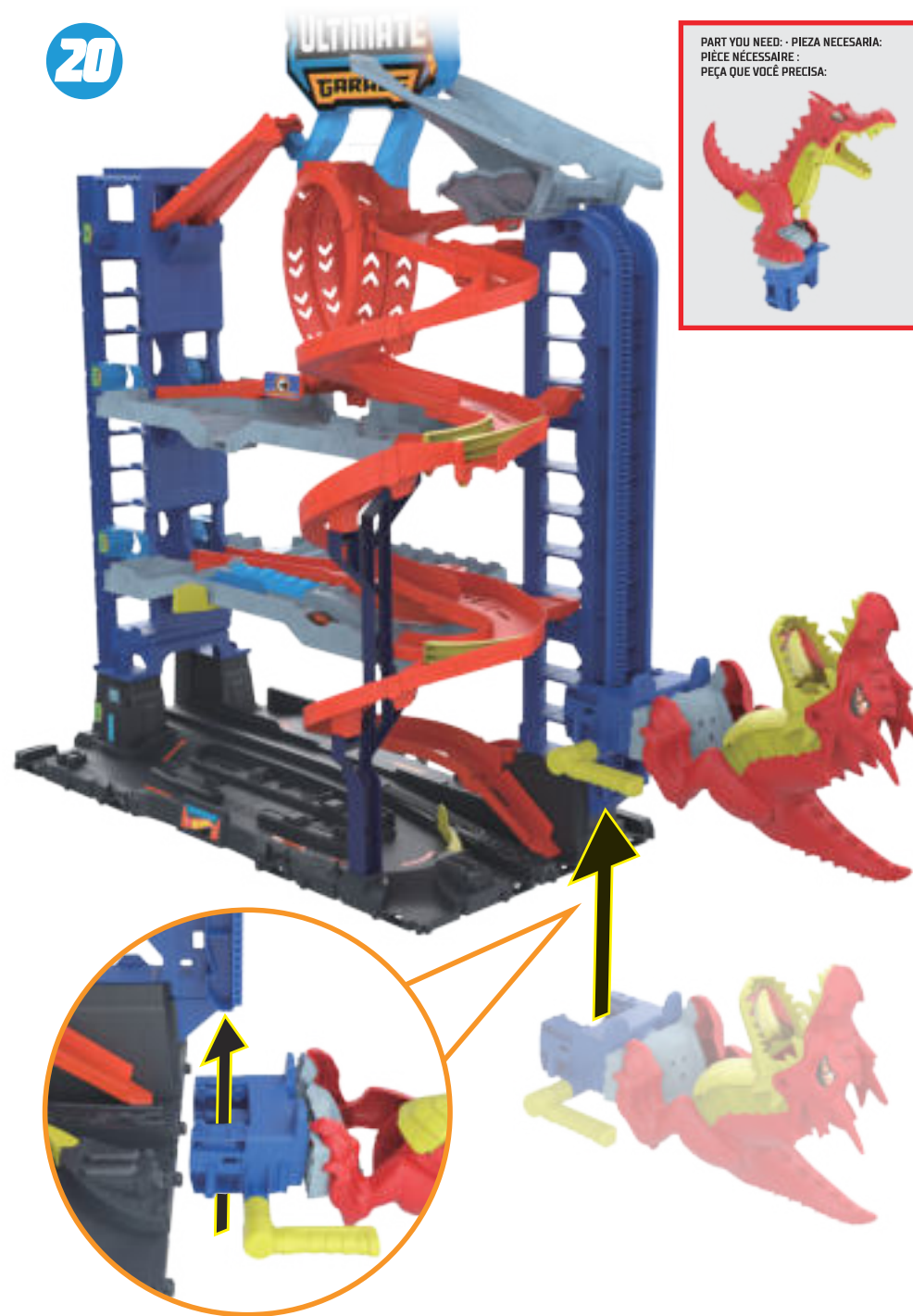

21



22

PARTS YOU NEED:
PIEZAS NECESARIAS:
PIÈCES NÉCESSAIRES:
PEÇAS QUE VOCÊ PRECISA:



23

PART YOU NEED: - PIEZA NECESARIAS:
 PIÈCE NÉCESSAIRES :
 PEÇA QUE VOCÊ PRECISA:

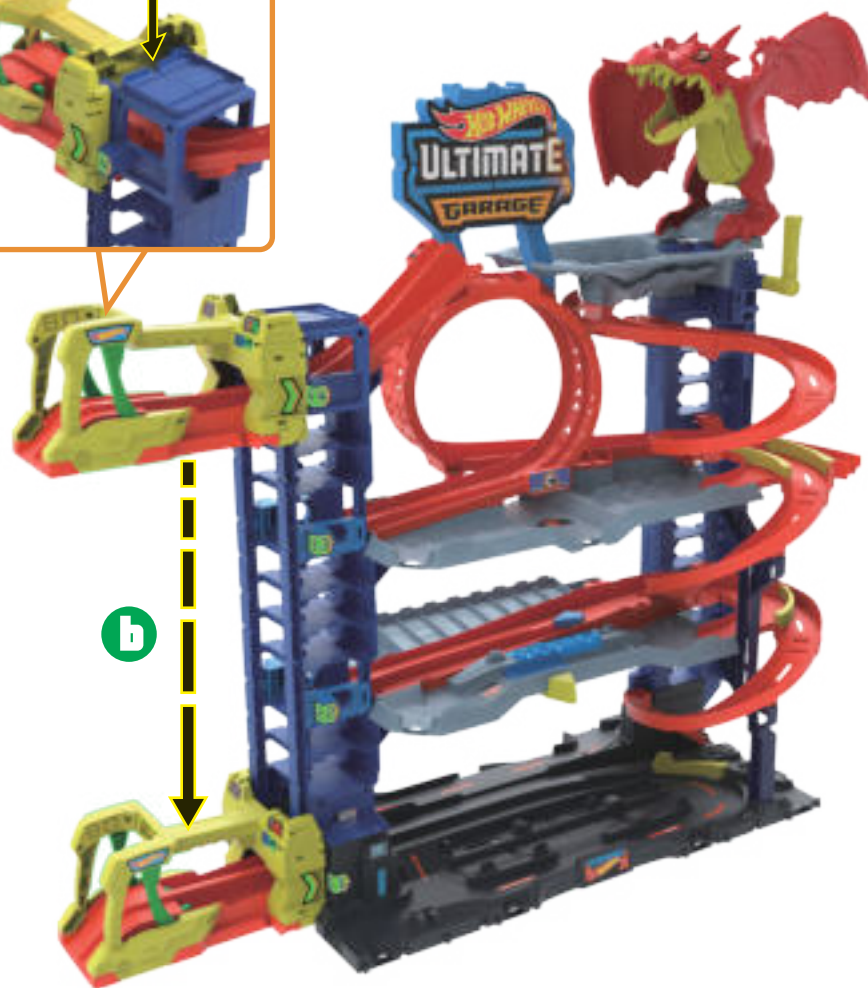

24

PARTS YOU NEED: - PIEZAS NECESARIAS:
 PIÈCES NÉCESSAIRES : - PEÇAS QUE VOCÊ PRECISA:

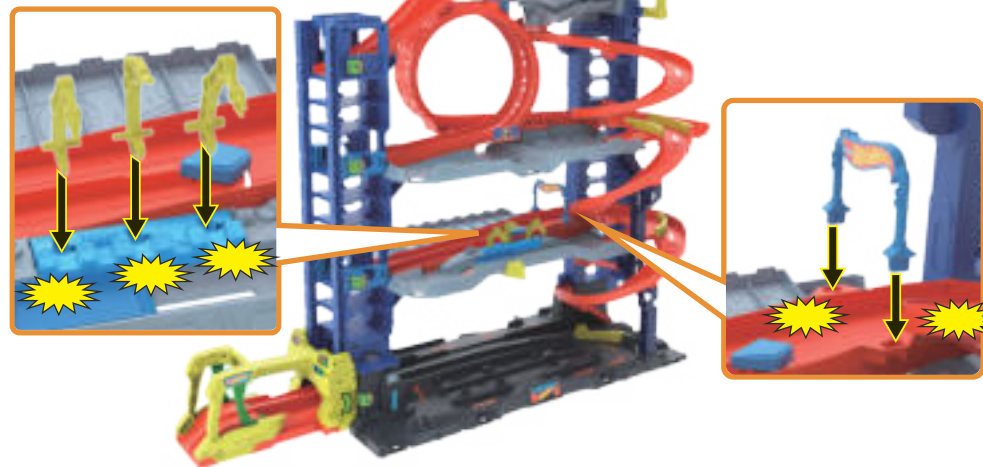

25

PARTS YOU NEED: - PIEZAS NECESARIAS: - PIÈCES NÉCESSAIRES : - PEÇAS QUE VOCÊ PRECISA:

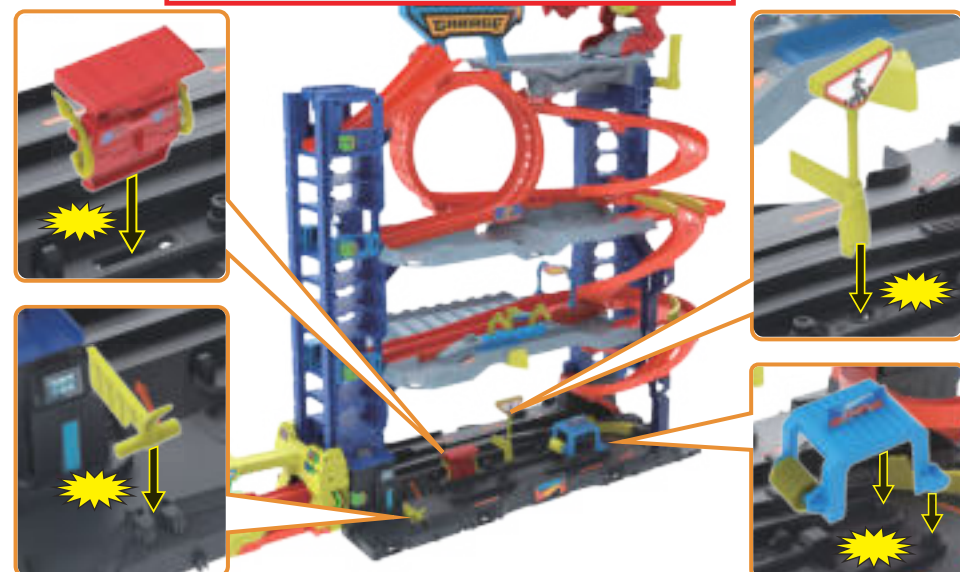



MOVING LAUNCHER & CAR LIFT • LANZADOR MÓVIL Y ELEVADOR DE VEHÍCULO
 DÉPLACEMENT DU LANCEUR ET DE L'ASCENSEUR À VEHICULES • LANÇADOR MÓVEL E ELEVADOR DE CARROS

1 MOVE TO DESIRED LEVELS TO ACTIVATE LAUNCHER. PULL THE TRIGGERS TO LAUNCH CARS! • MUÉVELA A LOS NIVELES QUE QUIERAS PARA ACTIVAR EL LANZADOR. ¡PRESIONA EL GATILLO PARA LANZAR VEHÍCULOS! • DÉPLACEZ JUSQU' AUX NIVEAUX SOUHAITÉS POUR ACTIVER LE LANCEUR. APPUYEZ SUR LES DÉTENTES POUR LANCER LES VEHÍCULES! • MOVA PARA OS ANDARES DESEJADOS PARA ATIVAR O LANÇADOR. PUXE O GATILHO PARA LANÇAR OS CARROS!

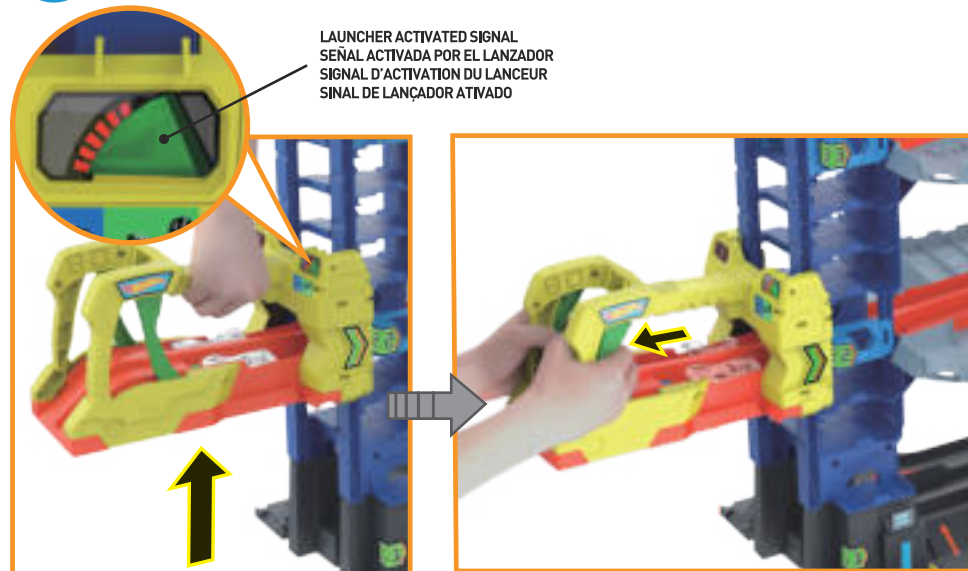

2 MOVE TO PARKING SPOTS AND DRIVE IN. MUÉVETE A LOS LUGARES DE ESTACIONAMIENTO Y CONDUCE. DÉPLACEZ JUSQU' AUX ESPACES DE STATIONNEMENT ET ROULEZ À L'INTÉRIEUR. VÁ PARA AS VAGAS DE ESTACIONAMENTO E DIRIJA.

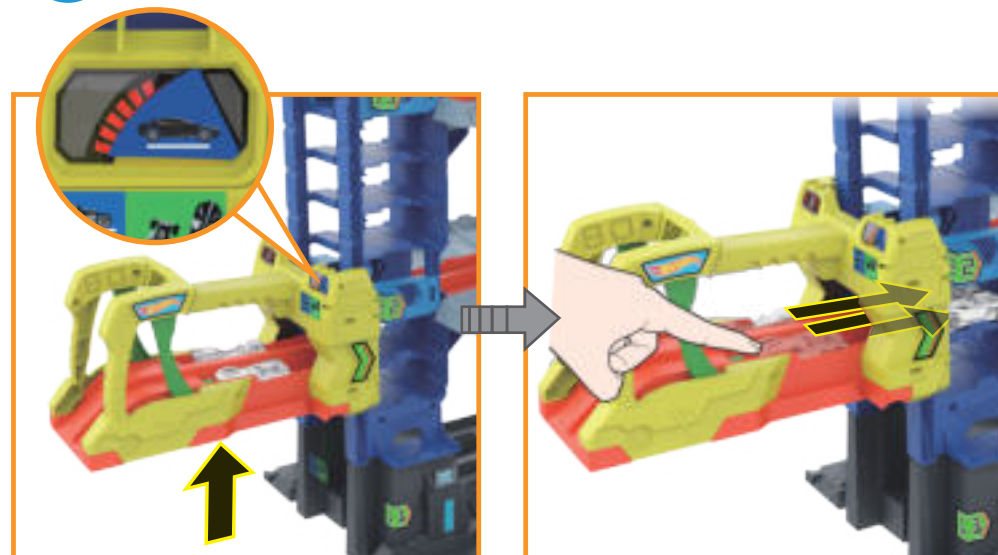

TO PLAY • PARA JUGAR
 PLACE AU JEU • COMO BRINCAR



1 LOAD CARS. • CARGA LOS VEHÍCULOS.
INSÉREZ LES VÉHICULES. • COLOQUE OS CARROS.



3 PUMP GAS AND CLEANING ON LEVEL 1. • CARGA GASOLINA Y LIMPIA EL VEHÍCULO EN EL NIVEL 1.
FAITES LE PLEIN ET LE NETTOYAGE AU NIVEAU 1. • POSTO DE GASOLINE E LAVA-RÁPIDO NO 1º ANDAR.

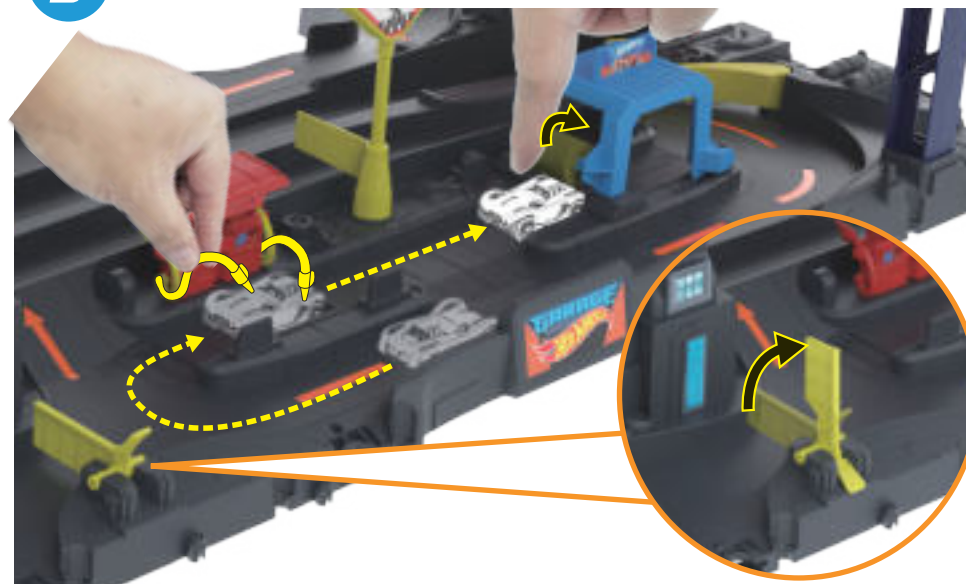

2 PULL THE TRIGGERS TO LAUNCH! • ¡PRESIONA LOS GATILLOS PARA LANZAR!
APPUYEZ SUR LES DÉTENTES POUR LANCER! • PUXE OS LANÇADORES!

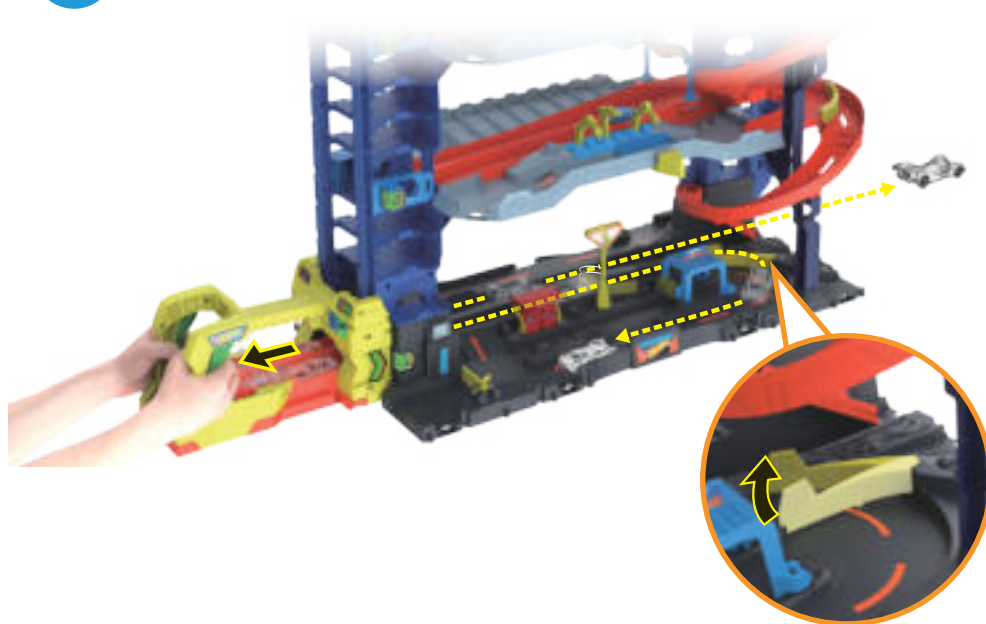

4 LAUNCH A DRAG RACE ON LEVEL 1! • ¡HAZ UNA CARRERA DE VELOCIDAD EN EL NIVEL 1!
LANCEZ UNE COURSE D'ACCÉLÉRATION AU NIVEAU 1! • INICIE UMA CORRIDA NO 1º ANDAR!

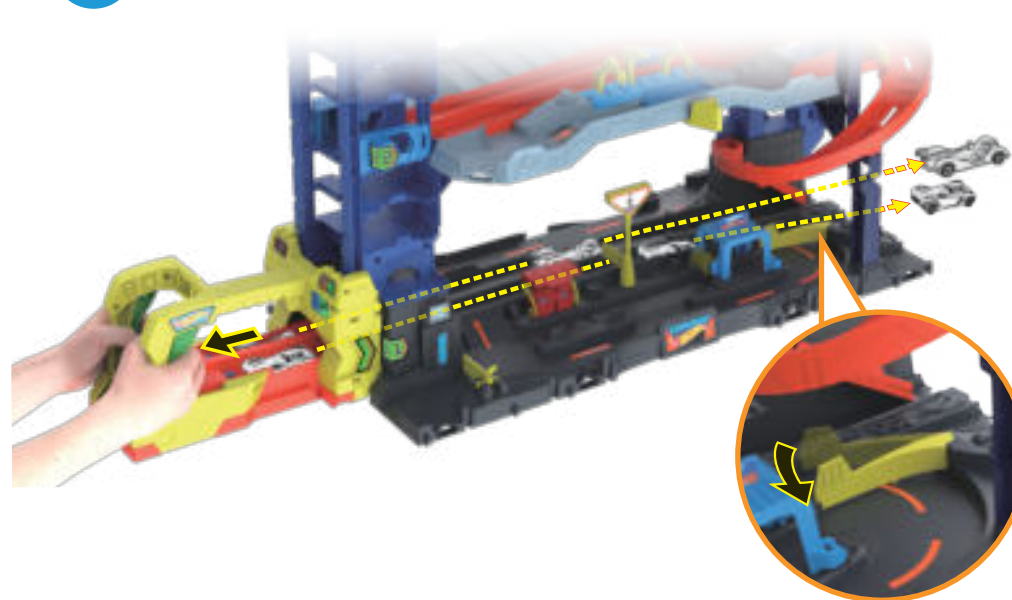

1 LAUNCH TO EXPLORE LEVEL 2. • LANZA PARA EXPLORAR EL NIVEL 2.
LANÇEZ POUR EXPLORER LE NIVEAU 2. • LANCE PARA EXPLORAR O 2º ANDAR.

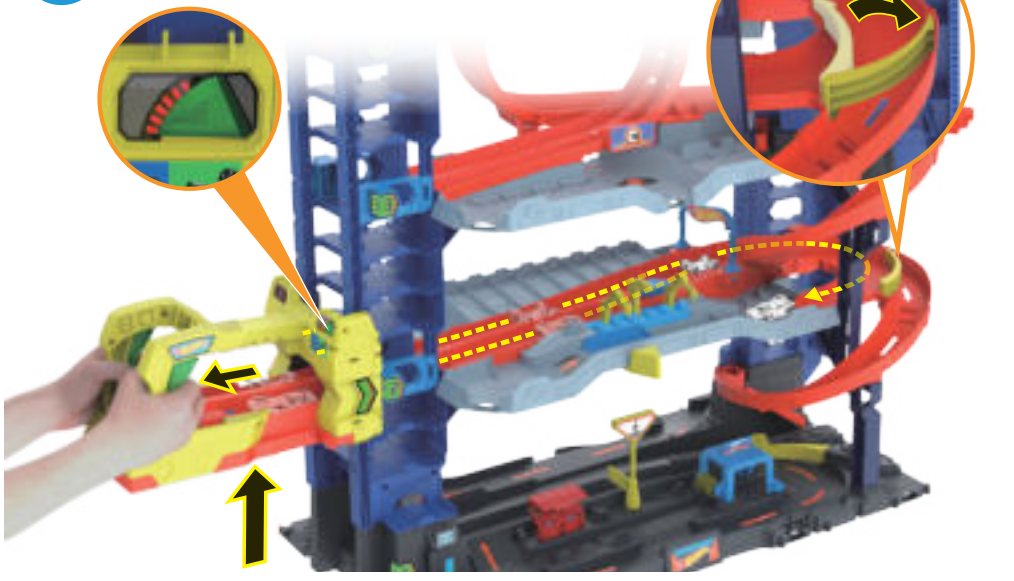

2 FIX YOUR CAR ON LEVEL 2. • ARREGLA EL VEHÍCULO EN EL NIVEL 2.
RÉPAREZ LE VÉHICULE AU NIVEAU 2. • CONSERTE SEU CARRO NO 2º ANDAR.

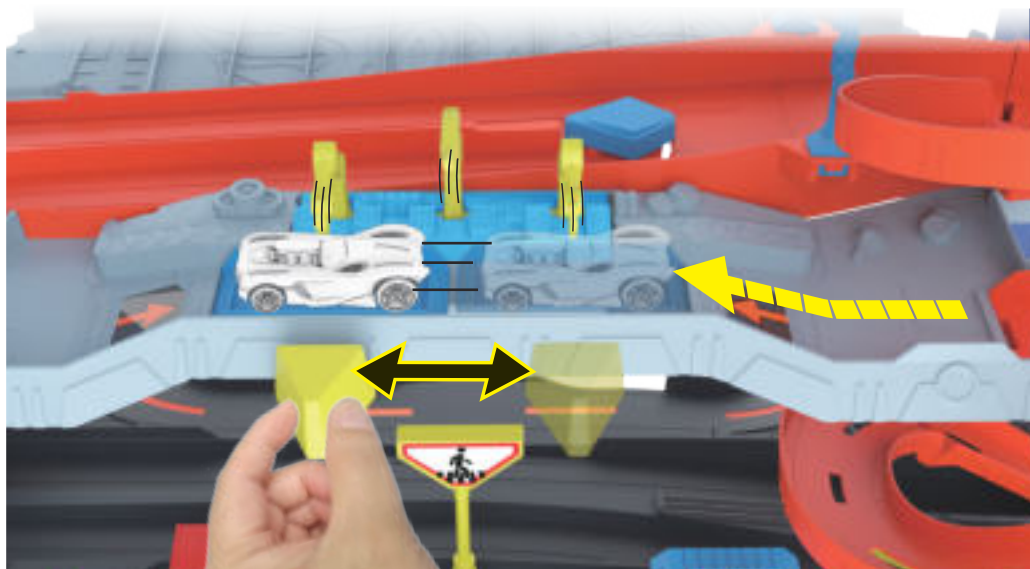

3 LAUNCH ON LEVEL 2 AND RACE DOWN THE CURVE! • ¡LANZA EN EL NIVEL 2 Y BAJA A TODA VELOCIDAD POR LA CURVA!
LANÇEZ AU NIVEAU 2 ET DÉVÉLEZ LA COURBE! • LANCE NO 2º ANDAR E CORRA NA CURVA!



TO PLAY • PARA JUGAR
PLACE AU JEU • COMO BRINCAR

1

LAUNCH THROUGH THE LOOP! • ¡LÁNZALO A TRAVÉS DEL LOOP!
LANCEZ DANS LA BOUCLE! • LANCE PARA PASSAR PELO LOOP!

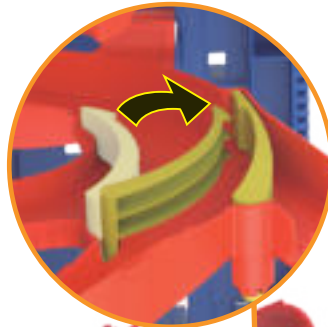

2

LAUNCH ON LEVEL 3 AND SPIRAL DOWN! • ¡LANZA EN EL NIVEL 3 Y BAJA POR LA ESPIRAL!
LANCEZ AU NIVEAU 3 ET DESCENDEZ LA SPIRALE! • LANCE NO 3º ANDAR E DESÇA PELA ESPIRALE!

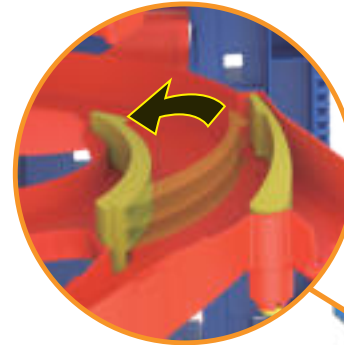

1

MOVE TO THE TOP. LAUNCH TO FACE THE DRAGON!
MUÉVETE A LA PARTE SUPERIOR. ¡LANZA PARA ENFRENTAR AL DRAGÓN!
MONTEZ JUSQU'AU SOMMET. LANCEZ POUR AFFRONTER LE DRAGON!
SUBA. LANÇA PARA ENFRENTAR O DRAGÃO!



2b

...OR HIT THE DRAGON'S BODY TO KNOCK IT DOWN!
...O GOLPEA SU CUERPO Y DERRÍBALO!
...OU FRAPPEZ LE CORPS DU DRAGON POUR LE FAIRE TOMBER!
...OU ACERTE O CORPO DO DRAGÃO PARA DERRUBÁ-LO!

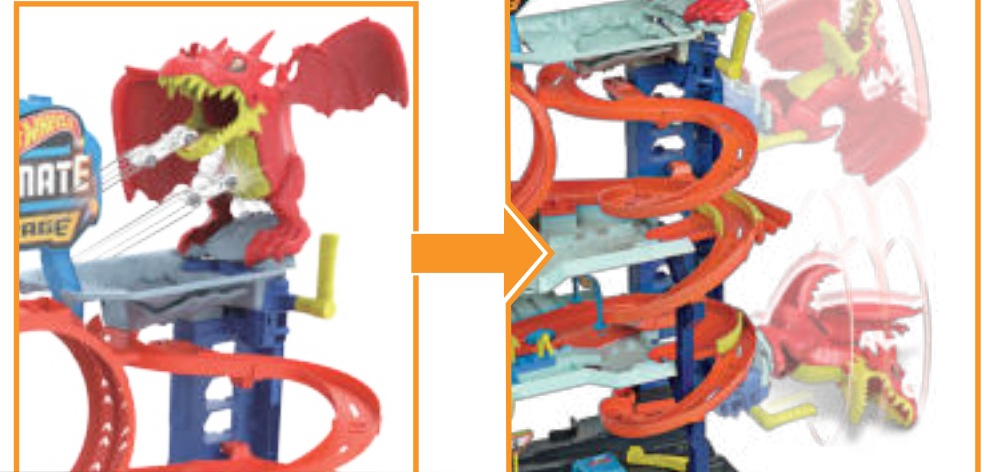

2a

GET EATEN AND DROPPED BACK DOWN...
¡ENTRA A LA BOCA DEL DRAGÓN PARA QUE TE ARROJE...
LE VÉHICULE SE FAIT AVALER ET DESCEND ENSUITE...
SEJA DEVORADO...



TO RESET • PARA RESTABLECER • POUR RÉENCLANCHER • REINICIAR



**MORE WAYS TO PLAY • MÁS MANERAS DE JUGAR
AUTRES FAÇONS DE JOUER • OUTRAS MANEIRAS DE BRINCAR**

PARK OVER **50** HOT WHEELS® CARS IN THE ULTIMATE GARAGE! • ESTACIONA MÁS DE **50** VEHÍCULOS HOT WHEELS EN EL ULTIMATE GARAGE!
STATIONNEZ PLUS DE **50** VÉHICULES HOT WHEELS DANS LE SUPER GARAGE! • ESTACIONE MAIS DE **50** CARROS HOT WHEELS NA MELHOR GARAGEM!

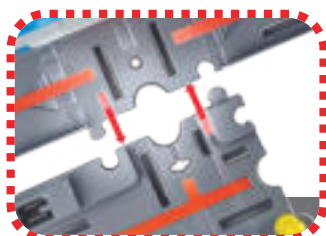

CONNECT TO EXTRA HOT WHEELS® TRACKS AND SETS! • ¡CONÉCTALO A PISTAS Y SETS HOT WHEELS ADICIONALES!
SE CONNECTE À D'AUTRES PISTES ET COFFRETS HOT WHEELS! • CONECTE A OUTRAS PISTAS E CONJUNTOS HOT WHEELS!
OTHER HOT WHEELS® TRACKS AND SETS SOLD SEPARATELY. • LOS OTROS SETS Y PISTAS HOT WHEELS SE VENDEN POR SEPARADO.
AUTRES PISTES ET COFFRETS HOT WHEELS VENDUS SÉPARÉMENT. • OUTROS CONJUNTOS E PISTAS HOT WHEELS SÃO VENDIDOS SEPARADAMENTE.

**PERFORMANCE TIPS • CONSEJOS DE RENDIMIENTO
CONSEILS D'UTILISATION • DICAS DE DESEMPENHO**

1

Lock all connection points in place for best performance.
Fija todos los puntos de conexión para obtener el mejor rendimiento.
Verrouillez tous les points de connexion pour un meilleur rendement.
Trave todos os pontos de conexão no lugar para obter o melhor desempenho.



BACK · ATRÁS · ARRIÈRE
PARTE DE TRÁS

2

To avoid vehicle slowing down by itself on the track, use tweezers or a toothpick (not included) to remove lint around the vehicle's axles. • Para evitar que el vehículo pierda velocidad por sí solo en la pista, quita la pelusa de los ejes del vehículo usando unas pinzas o un palillo de dientes (no se incluyen). • Pour éviter que le véhicule ne ralentisse tout seul sur la piste, utilisez une pince à épiler ou un cure-dent (non fournis) pour retirer la poussière autour des essieux du véhicule. • Para evitar que o veículo desacelere sozinho na pista, use pinças ou um palito (não incluídos) para remover os fiapos dos eixos do veículo.



PERFORMANCE TIPS • CONSEJOS DE RENDIMIENTO
CONSEILS D'UTILISATION • DICAS DE DESEMPENHO