

MEGA™

POKÉMON™



SNORLAX
RONFLEX
RELAXO

HLB70



Build Construisez

Construye
Constrói
Bauen
Стройте



Share Partagez

Comparte
Partilha
Teilen
Делитесь



Device not included | Appareil non inclus | Dispositivo no incluído
Dispositivo não incluído | Gerät nicht enthalten
Устройство не входит в комплект

megaunboxed.com



1



2x

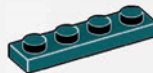

1x



1x

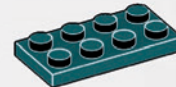

1x



1x

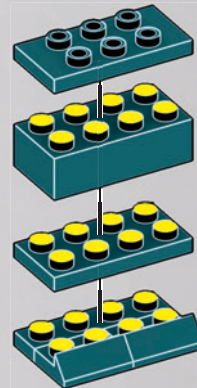

2



2x



2x

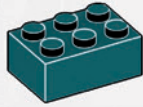

1x

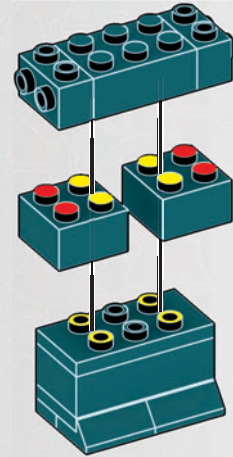

3



2x

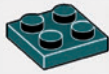

1x

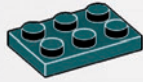

2x



2x

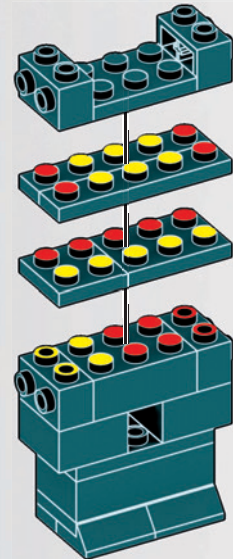

4



2x



2x

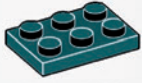

1x



2x

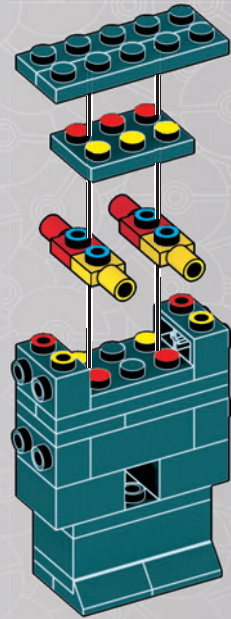

5



1x



2x



2x



1x

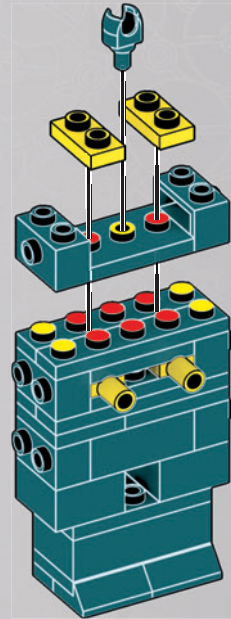

6



2x



2x



2x

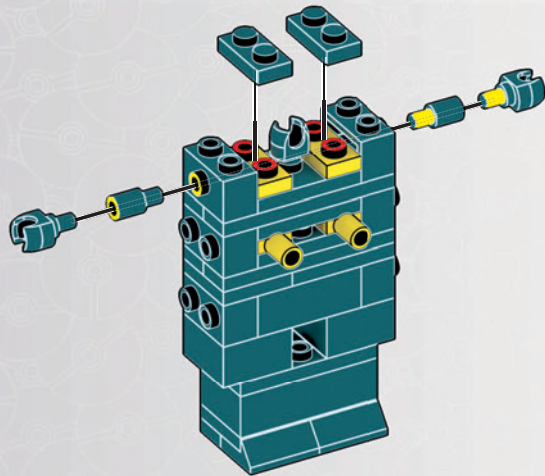

7



2x



2x

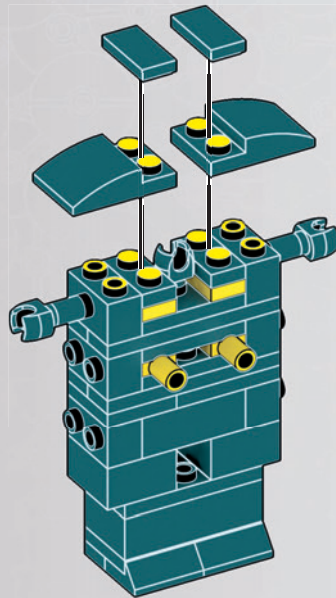

1

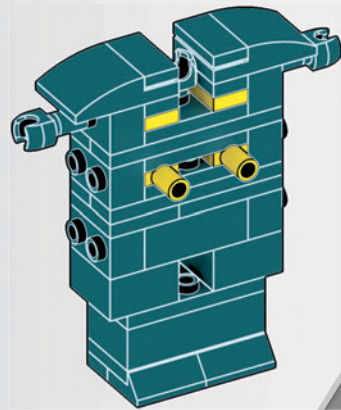

2

8



6x



2x



4x



4x



4x

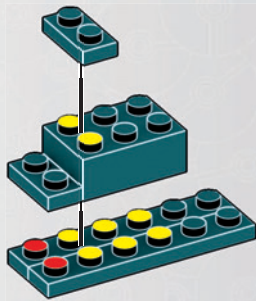

1

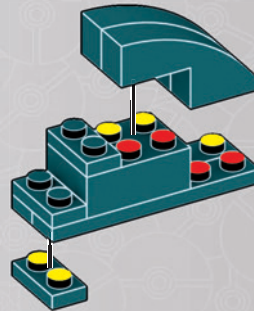

2

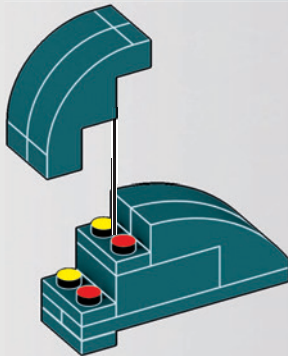

3

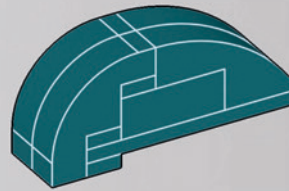

4

x2

9



1x

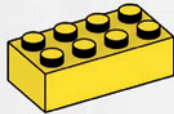

1x

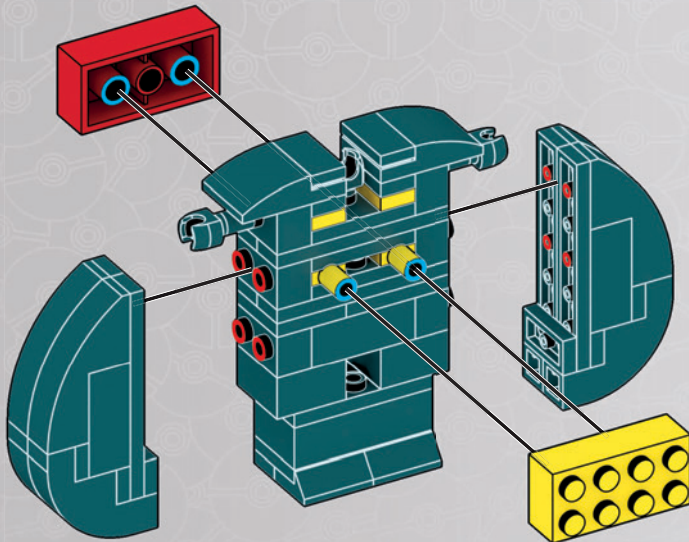

1

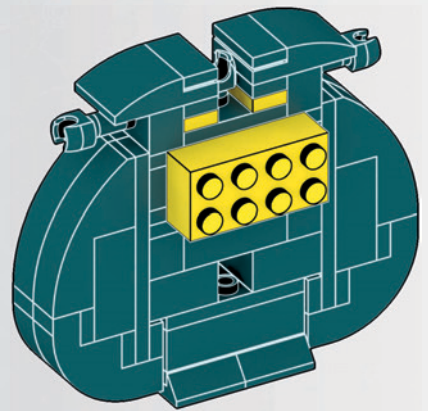

2

10



3x



1x

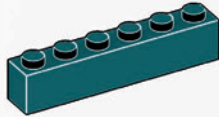

1x

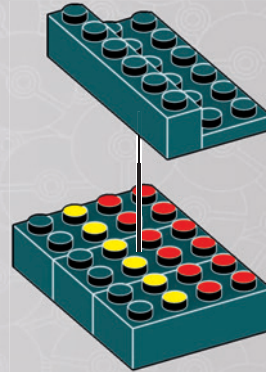

1

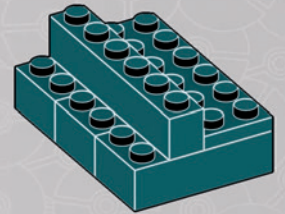

2

11



2x



1x

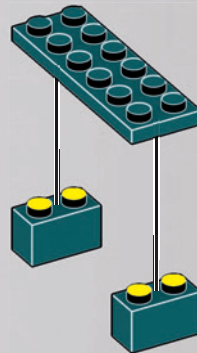

12

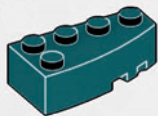

1x



1x



1x



1x

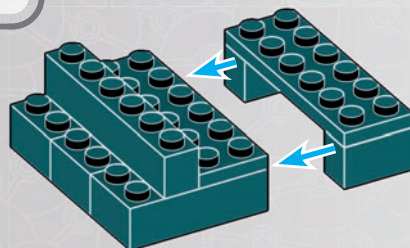

1

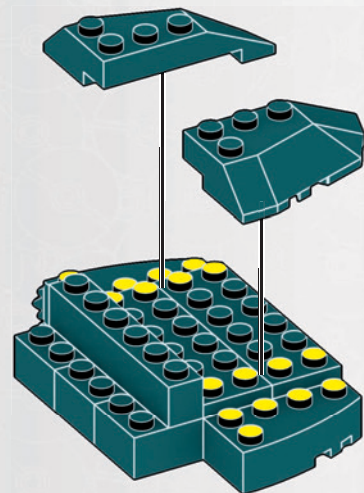

2

13



1x



2x

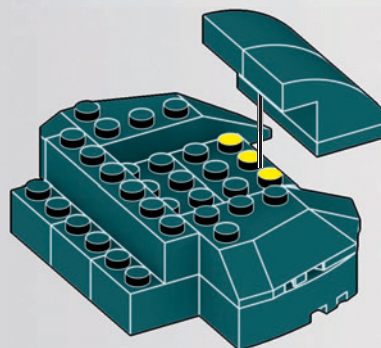
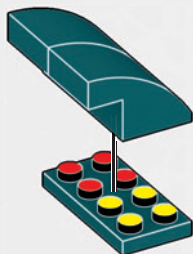

14



2x



1x



1x

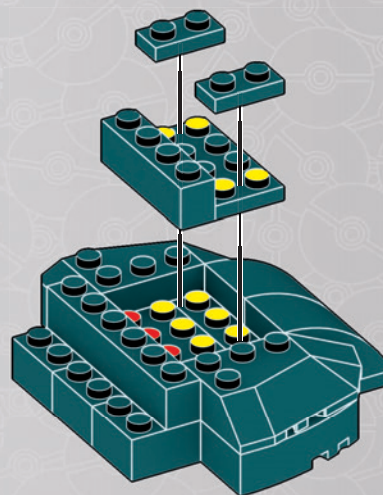

15

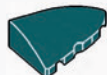

1x



1x

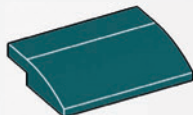

1x

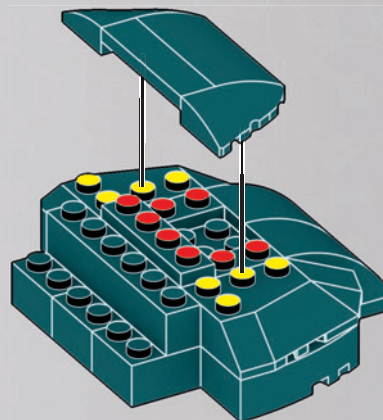

16



2x



2x

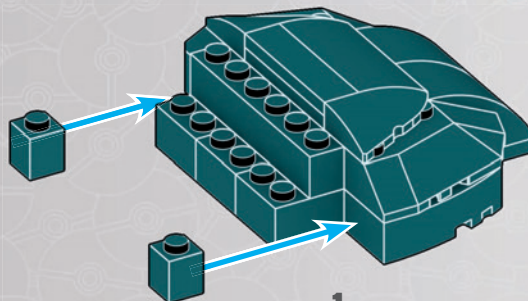

1

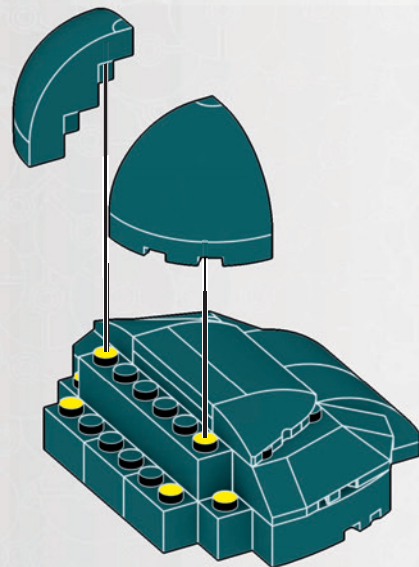

2

17



4x

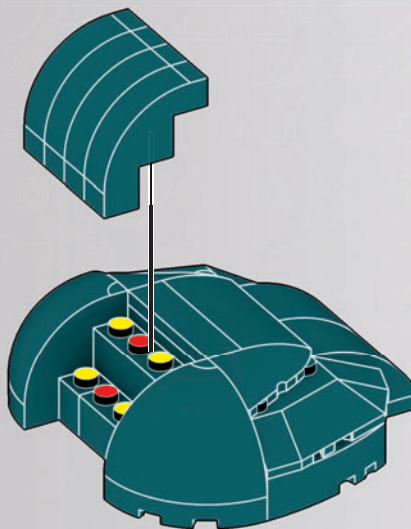

1

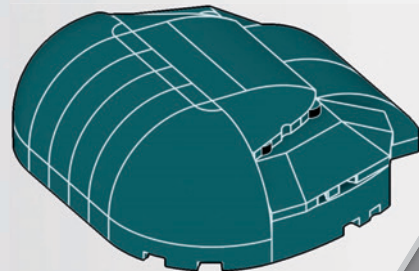

2

18



2x

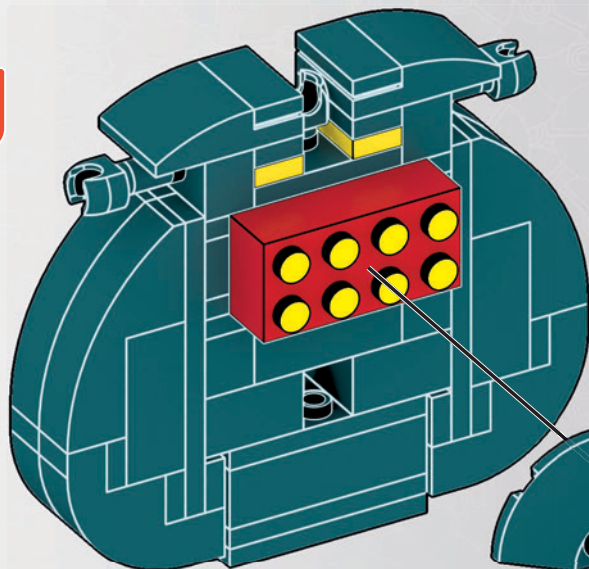
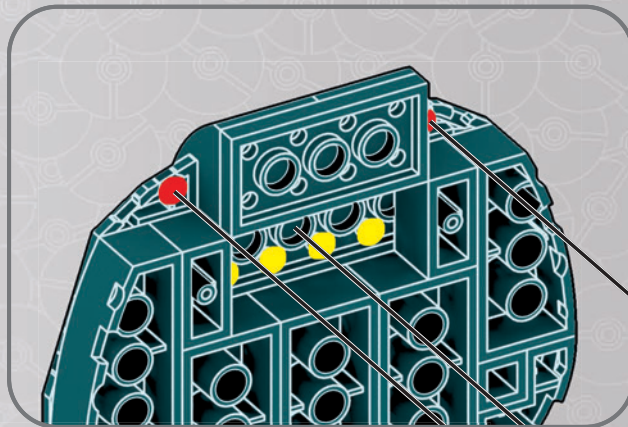

1

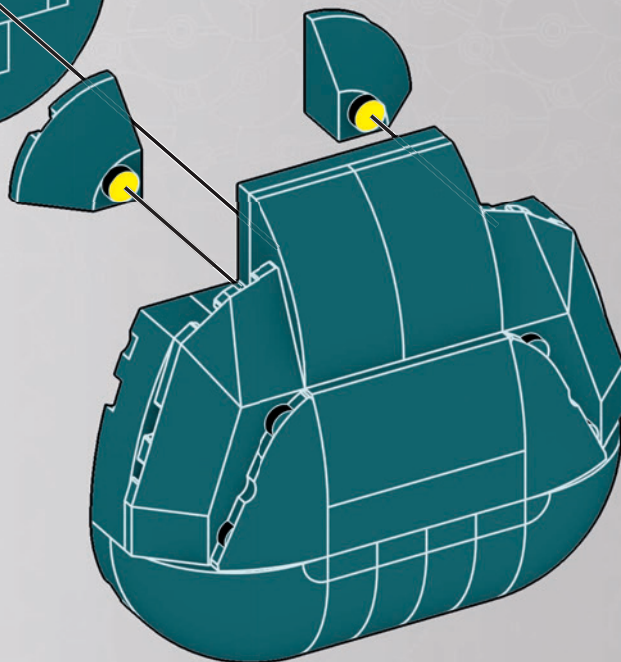

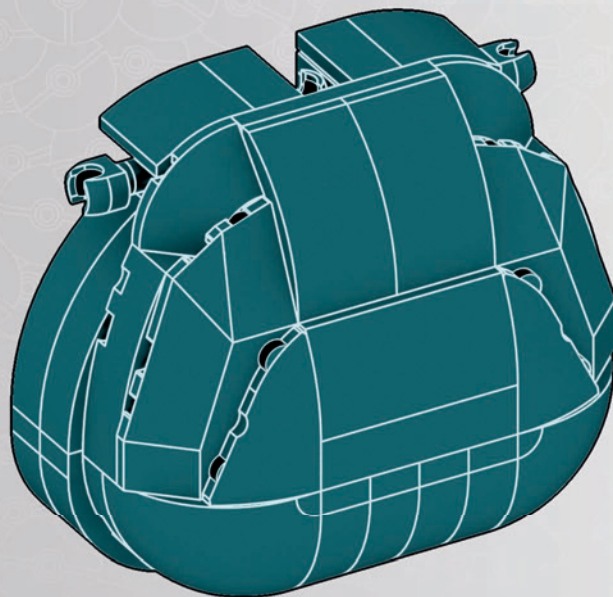

2



19



2x



2x

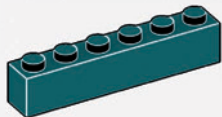

1x

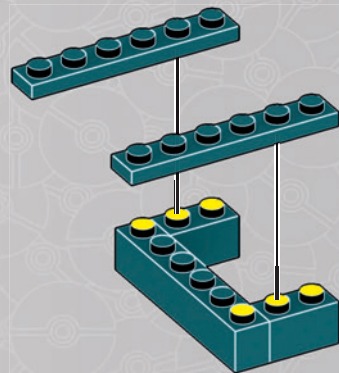

20



2x



2x



2x



1x

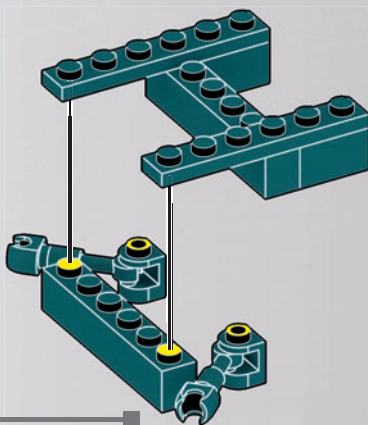
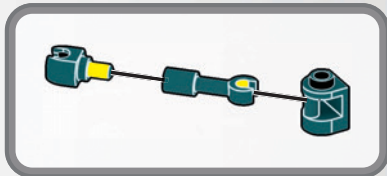

1

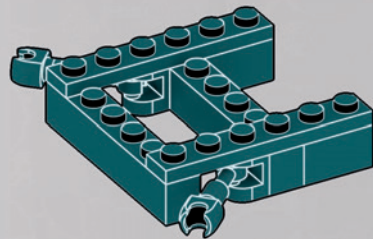

2

21



1x

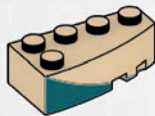

1x

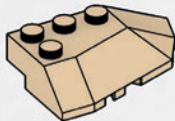

1x

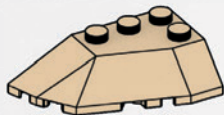

1x

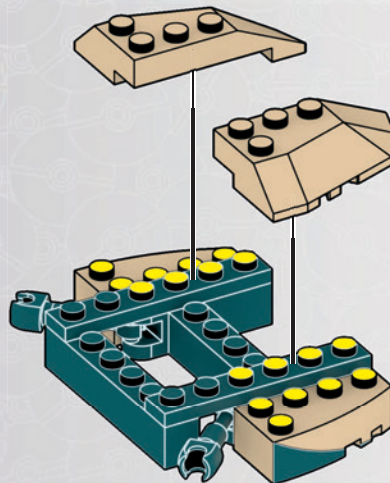

22



2x



1x



1x

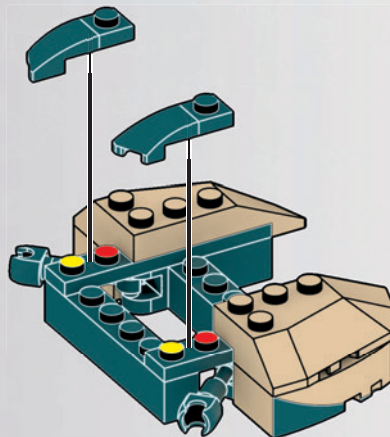

23



1x



1x

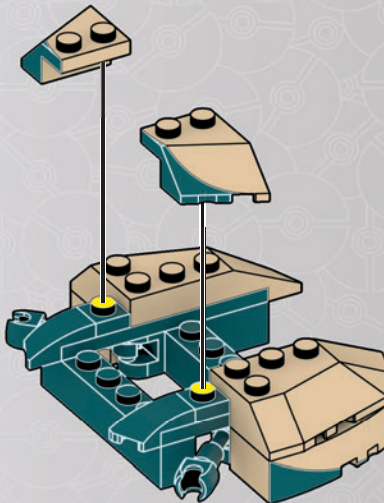

24



2x

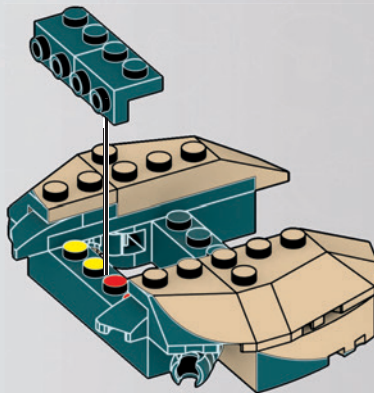

1

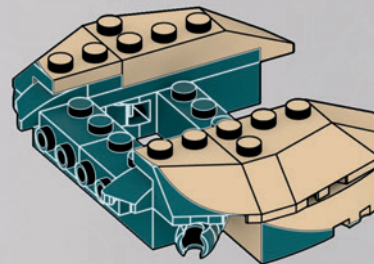

2

25



1x



3x



1x

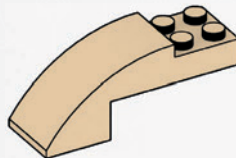

2x

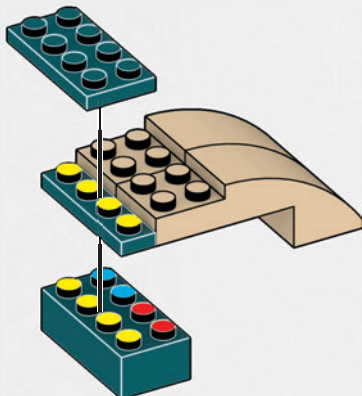

1

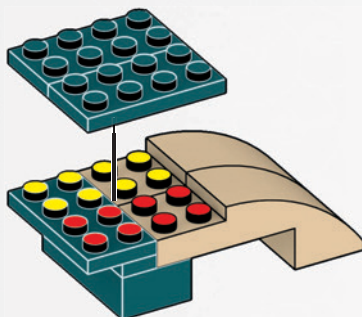

2

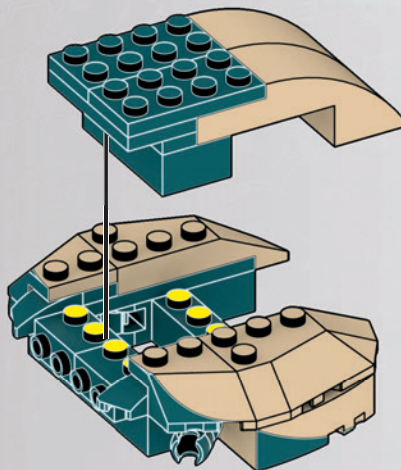

26



4x

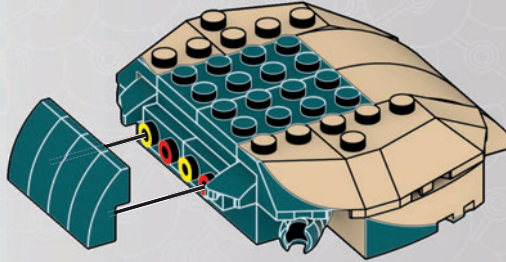

27

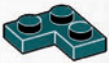

2x

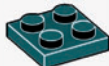

1x

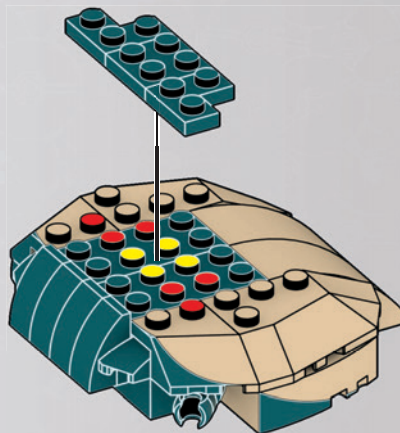

28



2x



2x

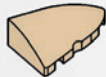

1x



1x



1x

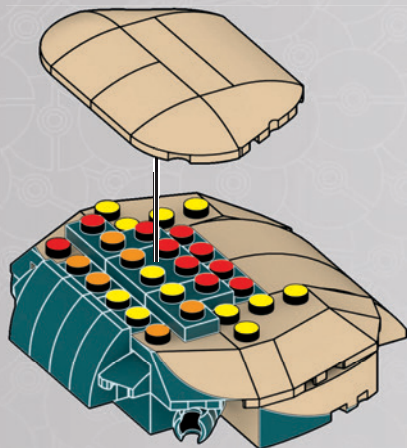

1

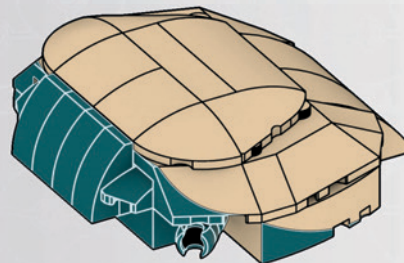

2

29



2x

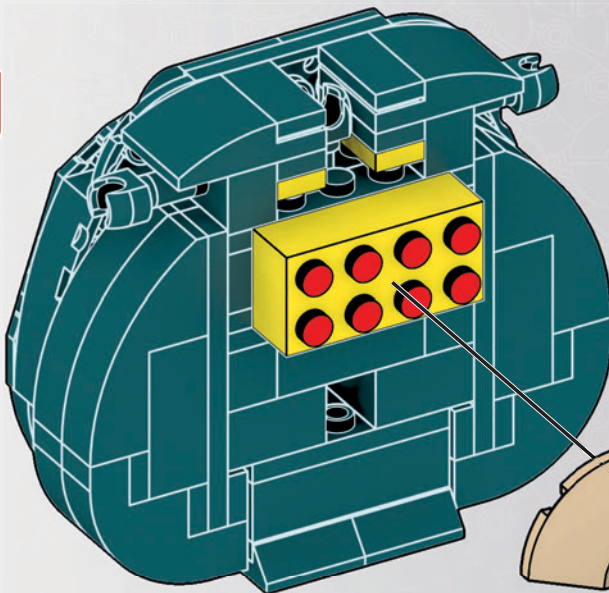
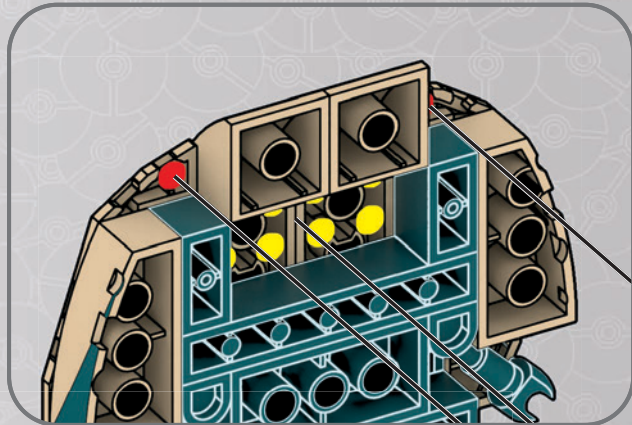

1

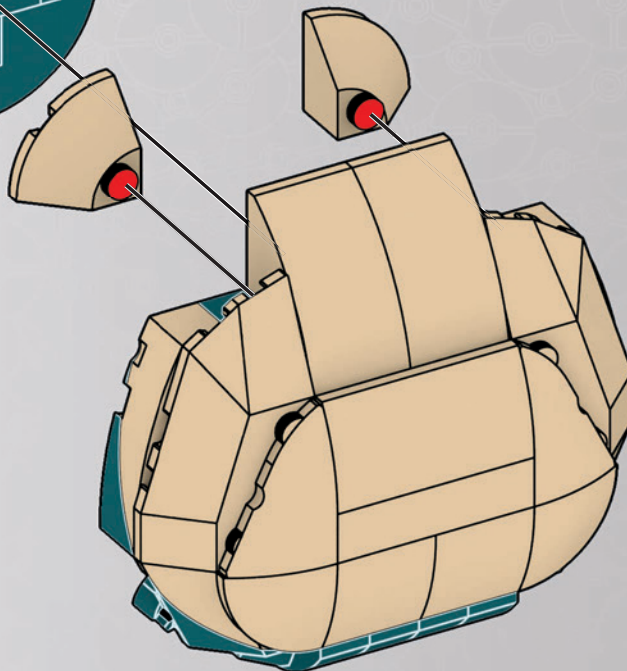

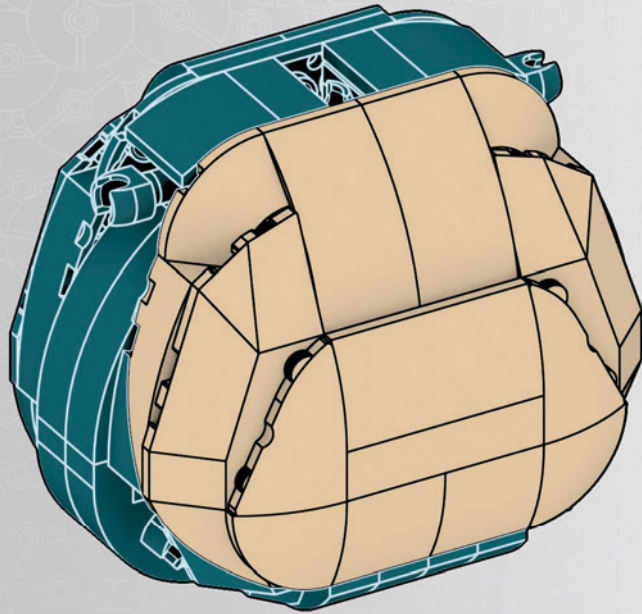

2



30

2x 1x 2x 2x

x2

1

2

31

2x 1x 2x

x2

32



6x



x3

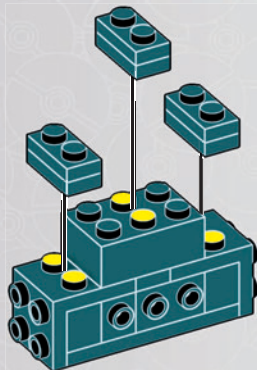

33



4x

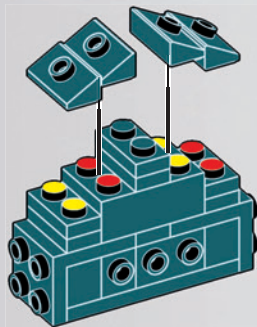

34



4x

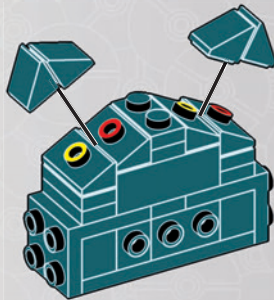

35



1x



1x



1x

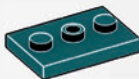

1x

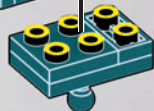
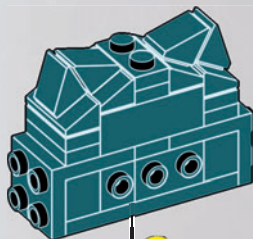
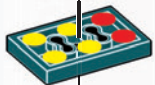

1

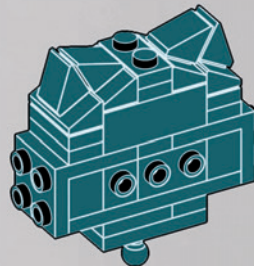

2

36



2x



4x

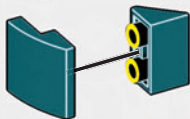

x2

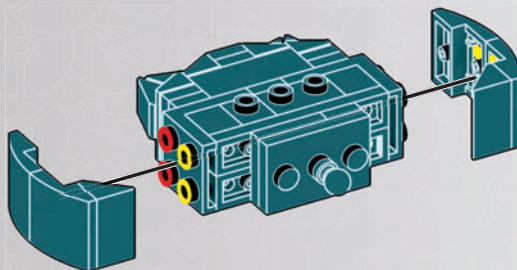

37



4x

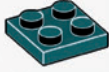

2x



1x



1x



2x



1x

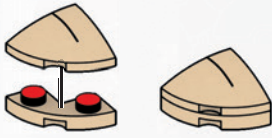

1

2

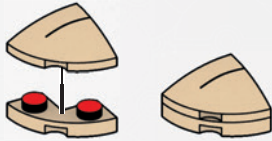

1

2

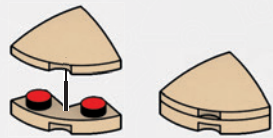

1

2

x2

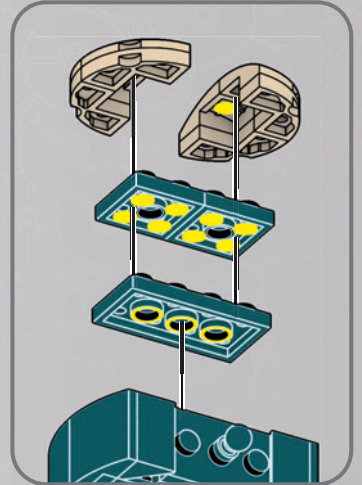
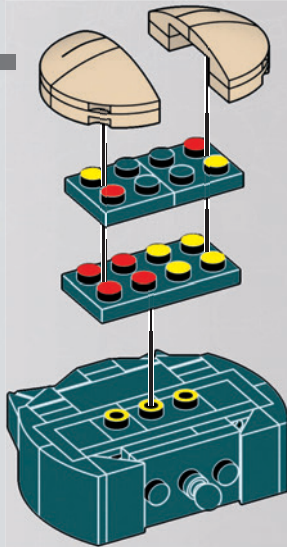

38



1x



1x



1x



1x

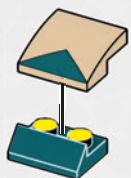

1



2

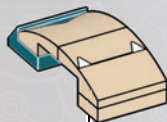

1



2

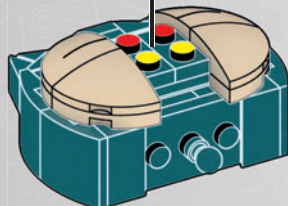

1

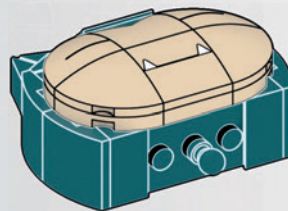

2

39



4x



2x



4x



1x



x4

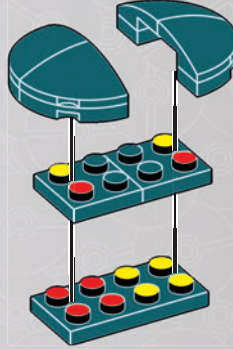

40

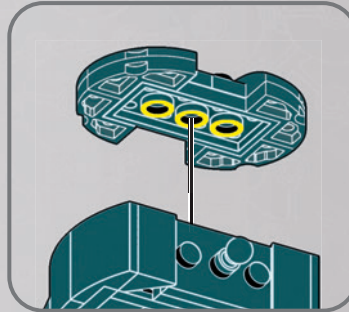
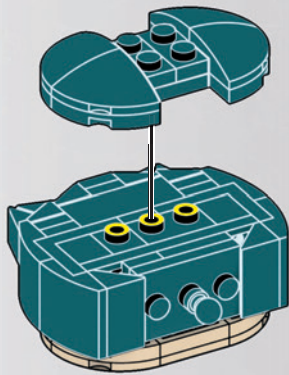

41



1x



1x



2x

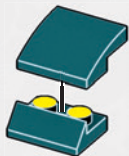

1



2



1



2

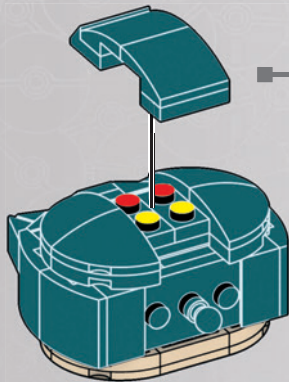

1

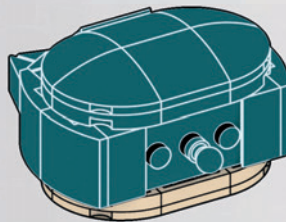

2

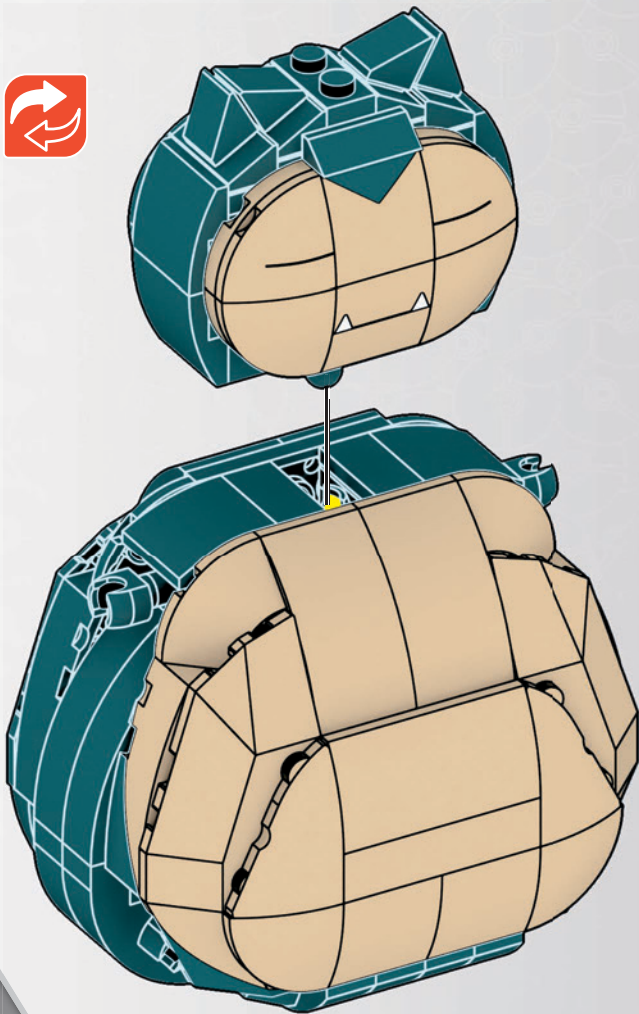

1

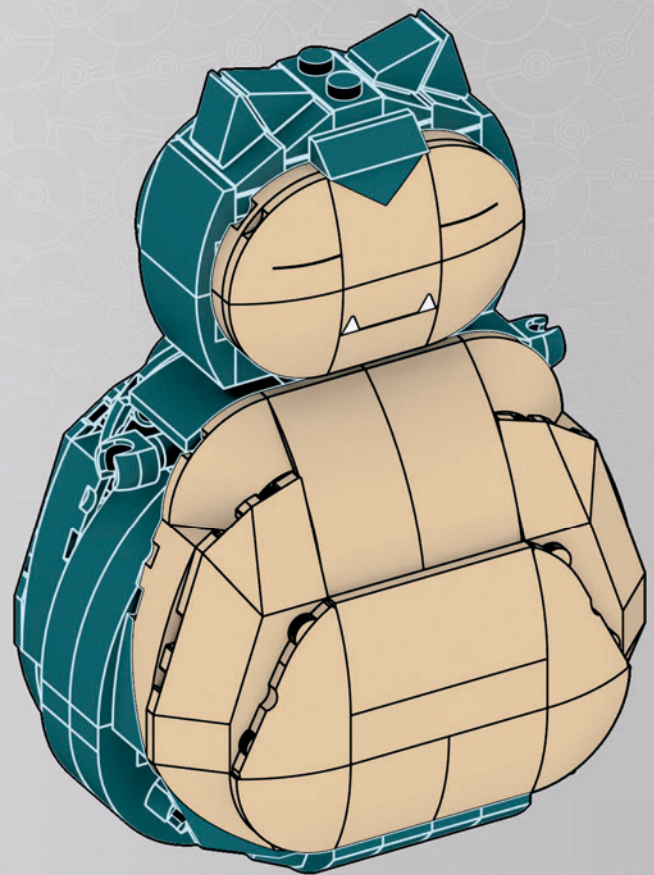

2

43

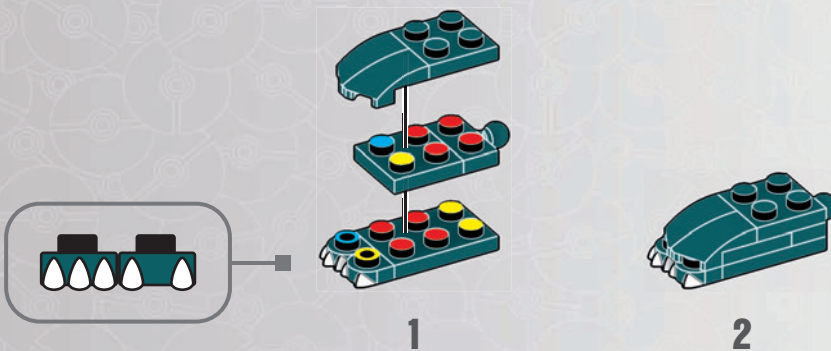

44

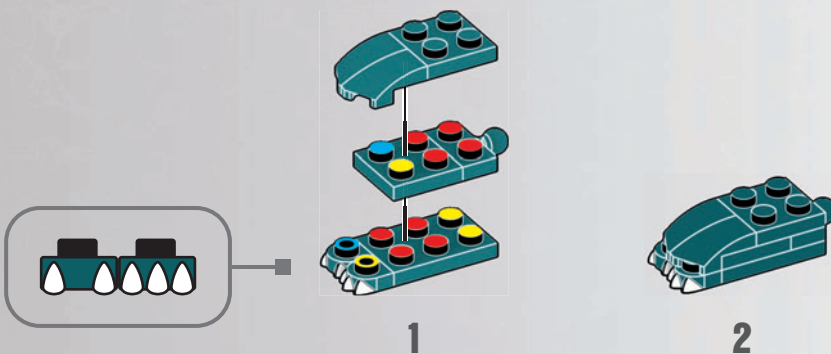

45

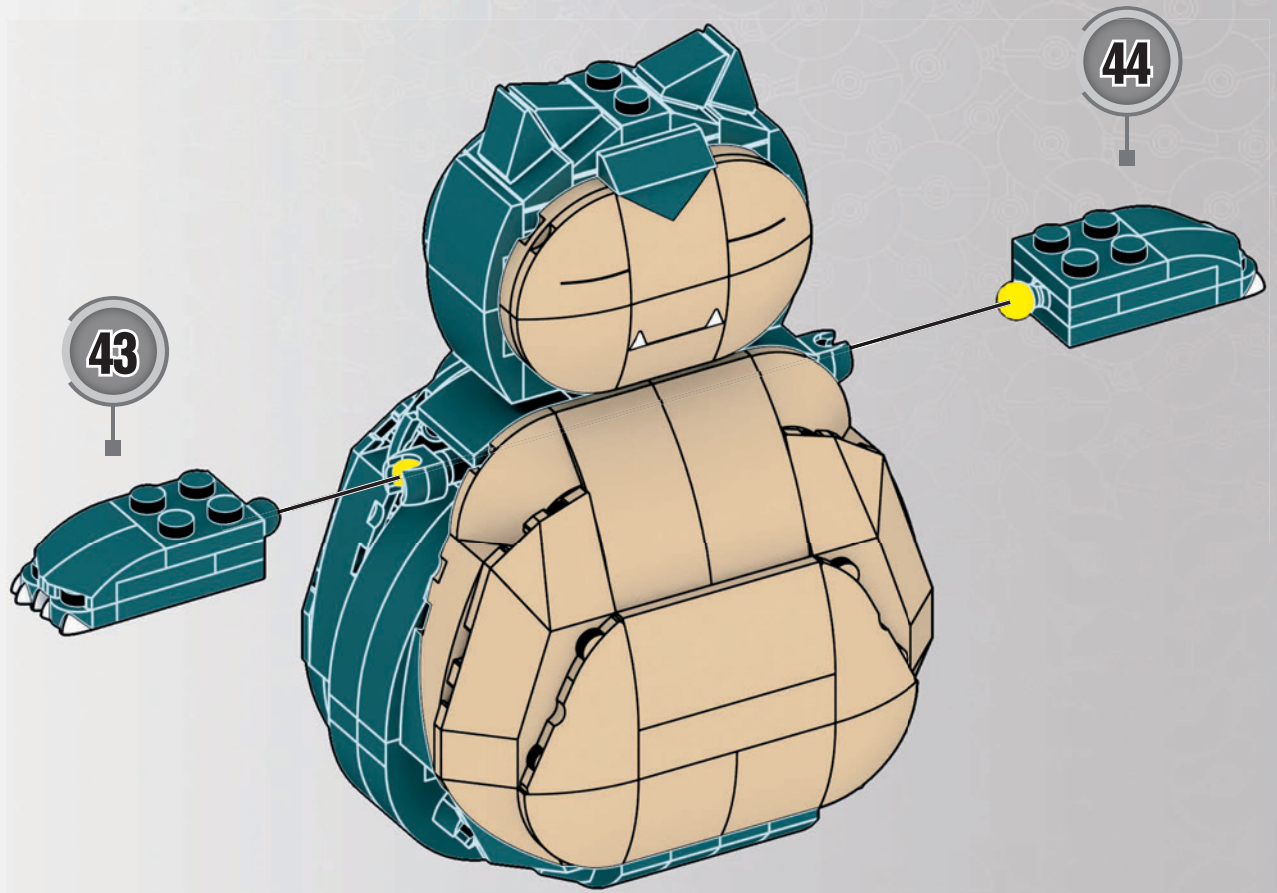

43

44

1

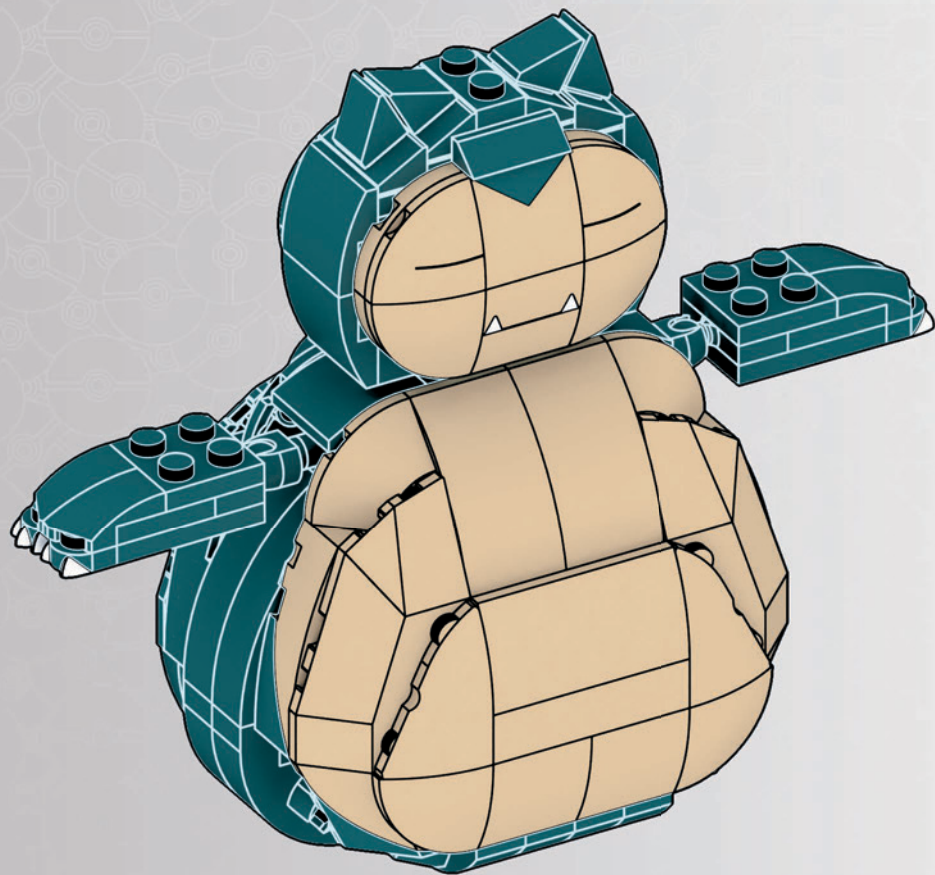

2

46

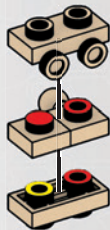
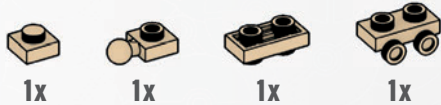

47



1



2

48

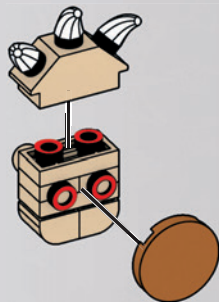

1

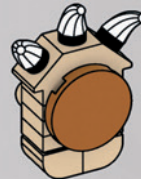

2

49

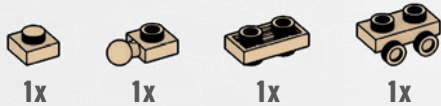

50

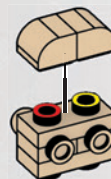

1



2

51

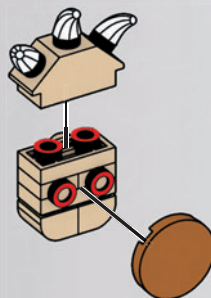
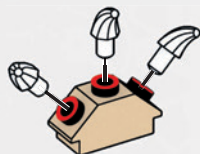
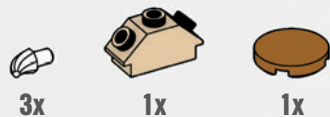

1

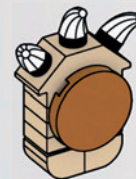

2

52

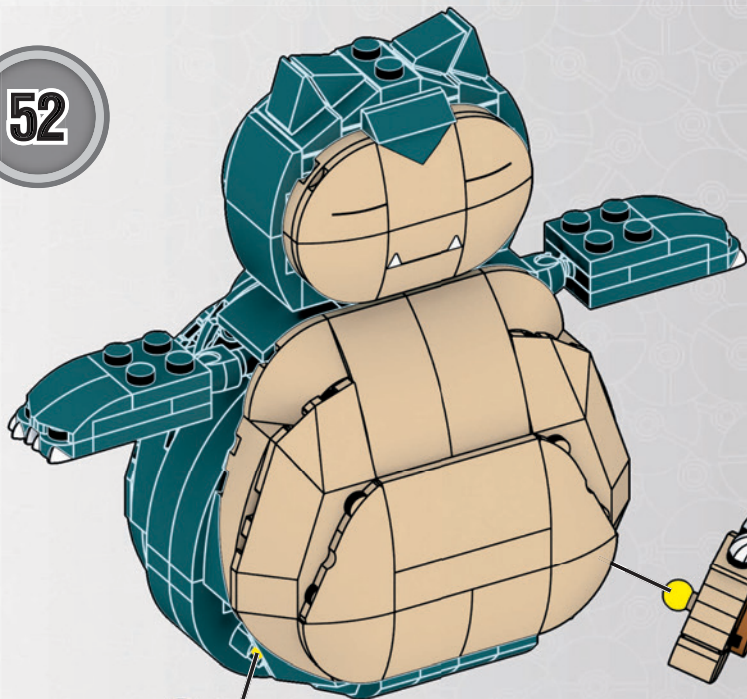

51

48

1

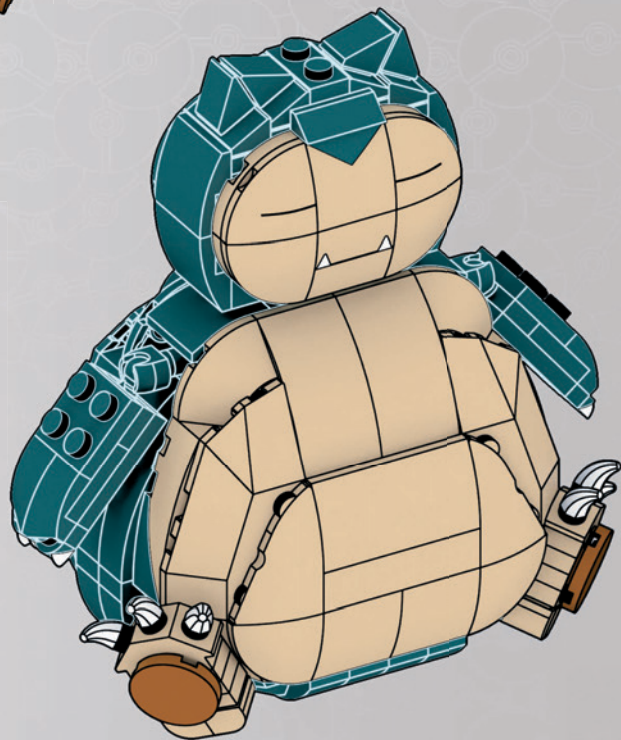

2

**POSE IT! / VARIEZ LES
POSES! / ¡PÓSALO!
VOCÊ PODE POSAR!
LÄSST SICH IN COOLE
POSEN BRINGEN!
МЕНЯЙ ПОЗЫ!**



6x
AM79425E



2x
AM74397VF



1x
AM78291VF



2x
AS-FPM11-11



2x
AS-FPM11-15



2x
AM03328BTN



2x
AM03328VF



4x
AM17787BTN



4x
AM15258VF



5x
AM78296VF



2x
AM79377BTN



2x
AM76058AMC



2x
AM76058BYE



2x
AM77445VF



2x
AM01086VF



2x
AM07629VF



2x
AM77206VF



2x
AM022501VF



2x
AM79246BYE



1x
AM09393BTN



18x
AM09393VF



2x
AM16680BTN



1x
AM16680VF



4x
AM73989VF



2x
AM78397VF



2x
AM76467BTN



2x
AM16679VF



4x
AM09835VF



2x
AM18014VF



3x
AM74427VF



3x
AM74426VF



6x
AM09013VF



6x
AM17502VF



2x
AM18601VF



4x
AM17788VF



2x
AM74060BTN



4x
AM04322VF



4x
AM04322BTN



2x
AM15484VF



2x
AM02215MY



10x
AM03773VF



1x
AM01146VF



1x
AS-FPM11-03



1x
AS-FPM11-04



4x
AM76525BTN



4x
AM76525VF



2x
AM74106BTN



6x
AM74106VF



1x
AS-FPM11-01



1x
AS-FPM11-02



2x
AM04320BTN



2x
AM04320VF



2x
AM09023VF



1x
AS-FPM11-13



1x
AS-FPM11-14



1x
AM75525BTN



1x
AM75526BTN



1x
AM75525VF



1x
AM75526VF



2x
AM17509VF



5x
AM03772VF



2x
AM19012VF



2x
AM01141VF



4x
AM03873VF



2x
AM09593VF



1x
AM01087VF



1x
AM18299VF



8x
AM09493VF



1x
AM09826VF



1x
AM09825VF





1x
AM09033BYE



5x
AM09033VF



1x
AM09033AMC



1x
AS-FPM11-05

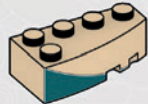

1x
AS-FPM11-06



2x
AM18732VF



8x
AM72257VF



4x
AM18657VF

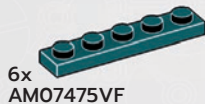

6x
AM07475VF

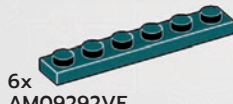

6x
AM09292VF



1x
AM72412BTN

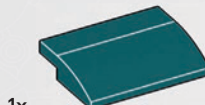

1x
AM72412VF



1x
AM18227BTN



1x
AM18226BTN



1x
AM18227VF



1x
AM18226VF



2x
AM01480VF



3x
AM01313VF



2x
AM19781VF



2x
AM18656BTN

Missing pieces? • Pièces manquantes?

¿Partes faltantes? • Perdeu peças?
Fehlen Teile? • Не хватает деталей?

support.megabrands.com

ATTENTION : DANGER
D'ÉTOUFFEMENT. - PRÉSENCE DE PETITS ÉLÉMENTS.
NE CONVIENT PAS AUX ENFANTS DE MOINS DE 3 ANS.
ATENÇÃO! NÃO INDICADO / NÃO
RECOMENDÁVEL PARA CRIANÇAS MENORES DE 3
(TRÊS) ANOS POR CONTER PARTE(S) PEQUENA(S)
QUE PODE(M) SER ENGOLIDA(S) OU ASPIRADA(S)
PODENDO PROVOCAR ASFIXIA.

تحذير:
غير مناسبة للأطفال دون 36 شهراً - قطع صغيرة.

AVVERTENZA: Contiene pezzi di piccole dimensioni.
ACHTUNG: Kleine Teile.
OSTRZEŻENIE: Małe części. Niebezpieczeństwo zadławienia.
WAARSCHUWING: Kleine onderdelen.
ПРЕДУПРЕЖДЕНИЕ: Мелкие детали.
ADVARSSEL: Indeholder små dele.
VARNING: Smådelar
ADVARSSEL: Små deler
VAROITUS: Pieniä osia
ΠΡΟΣΟΧΗ: Περιλαμβάνονται μικρά κομμάτια.
UYARI: Küçük parçalar.
UPOZORNĚNÍ: Malé díly
UPOZORNENIE: Malé časti
FIGYELMEZTETÉS: Kis alkatrészek.

⚠ WARNING : CHOKING HAZARD. - Small parts. Not for children under 3 years.
ADVERTENCIA: PELIGRO DE ATAGANTAMIENTO. Juguete no recomendado
para menores de 3 años, porque contiene piezas pequeñas que podrían provocar
asfixia en caso de ser ingeridas o inhaladas por el/la niño/a.

警告:
のどにつまる危険 小さな部品が含まれています
3歳以下の子供には与えないで下さい。



警告!
不适合3岁以下儿童使用。
内含小零件。

Snorlax / Ronflex / Relaxo

Mattel Europa B.V., Gondel 1, 1186 MJ Amstelveen, Nederland. Mattel U.K. Limited, The Porter Building, 1 Brunel Way, Slough SL1 1FQ, UK. Mattel France, Parc de la Cerisaie, 1/3/5 allée des Fleurs, 94260 Fresnes Cedex. N° Cristal 0969 36 99 99 (Numéro non surtaxé) ou www.lesjouetsmattel.fr. Mattel Belgium, Trade Mart, Atomiumsquare, Bogota 202 - B 275, 1020 Brussels. Gratis nummer België: 0800 - 16 936 - Gratis nummer Luxembourg: 800 - 22 784 - Gratis nummer Nederland: 0800 - 262 88 35. Deutschland: Mattel GmbH, Solmsstraße 83, D-60486 Frankfurt am Main. Schweiz: Mattel AG, Kirchstrasse 24, CH-3097 Liebefeld. Österreich: Mattel Ges.m.b.H., Campus 21, Liebermannstraße A01 404, A- 2345 Brunn/Gebrige. Mattel Italy Srl, Via Turati 4, 20121 Milano, Italy. Servizio assistenza clienti: Customerserv.italia@mattel.com - Numero verde 800 11 37 11. Mattel España, S.A, Aribau 200 pl. 9, 08036 Barcelona. c.servicio.spain@mattel.com Tel: +34 933 06 79 00 http://www.servicio.mattel.com/es. Mattel East Asia Ltd., Room 503-09 North Tower, World Finance Centre, Harbour City, Tsimshatsui, HK, China. Tel: (852) 3185-6500. Dimport & Diederkan Oleh: Mattel Continental Asia Sdn Bhd. Level 19, Tower 3, Avenue 7, No. 8 Jalan Kerinci, Bangsar South, 59200 Kuala Lumpur, Malaysia. Mattel South Africa (PTY) LTD, Office 102 B, 30 Melrose Boulevard, Johannesburg 2196. Distributor: Mattel Poland Sp. z o.o., Warsaw Trade Tower 34 p., ul. Chłodna 51, 00-867 Warszawa. Mattel Australia Pty. Ltd., 658 Church St., Richmond, Victoria, 3121. Consumer Advisory Service - 1300 135 312. Mattel AEBE, Εθνάρχου Μακαρίου 1, Κτήριο Κ-2, ΤΚ 17561, Παλαιό Φάληρο. Mattel Oyuncakçılık Tic. Ltd. Şti. İcerenköy Mah., Umut Sokak No: 10 - 12, Quick Tower kat:2 içkapı no:15 Ataşehir 34752, İstanbul, Türkiye. Tel: 0216 570 75 00. Импортёр/Уполномоченная организация: ООО "МАТТЕЛ" Российская Федерация, 105120 Москва, 2-й Сыромьятинский переулок 1; +7 495 287 79 39. Mattel Czech Republic s.r.o., The Forum, Václavské nám. 19, 11000 Praha1, Mattel, 333 Continental Boulevard, El Segundo, CA 90245, USA. Consumer Services: 1-800-465-MEGA (6342). Mattel Canada Inc., Mississauga, Ontario L5R 3W2. Consumer Services: You may call us free at Composez sans frais le 1-800-524-8697. Importado y distribuido por Mattel de México, S.A. de C.V., Miguel de Cervantes Saavedra No. 193, Pisos 10 y 11, Col. Granada, Alcaldía Miguel Hidalgo, C.P. 11520, México, Ciudad de México. R.F.C. MME-920701-NB3. Tels: 59-05-51-00 Ext. 5206 ó 01-800-463-59-89. Mattel Chile, S.A., Avenida América Vespuccio 501-B, Quilicura, Santiago. Tel: 1230-020-6213. Servicio al consumidor Venezuela: Tel: 0-800-100-9123. Mattel Argentina, S.A., Av. Libertador 1000, Piso 11 - Oficinas 109 y 111, Vicente López - Prov. Buenos Aires. Tel: 0800-666-3373. Mattel Colombia, S.A., Calle 123#7-07 P5, Bogotá. Tel: 01-800-710-2069. Mattel Perú, S.A., Av. Juan de Arona n° 151, Centro Empresarial Juan de Arona, Torre C, Piso 7, Oficina 704, San Isidro, Lima 27, Perú. RUC: 20425853865. Reg. Importador: 02350-12-JUE-DIGESA. Tel: 0800-54744. E-mail Latinoamérica: servicio.clientes@mattel.com. Mattel do Brasil Ltda.- CNPJ: 54.558.002/0001-20 - Rua Verbo Divino, 1488 - 2º. Andar - 04719-904 - Chácara Santo Antônio - São Paulo - SP - Brasil. Serviço de Atendimento ao Consumidor: fone 0800 575 0780. E-mail: sac.mattel@dobrazil@mattel.com



POKÉMON



HFG05



GWY77



Set(s) sold separately and subject to availability. / Ensemble(s) vendu(s) séparément. Certains produits peuvent ne pas être commercialisés.

/ Se vende(n) por separado y está(n) sujeto(s) a disponibilidad. / Conjunto(s) vendido(s) em separado e sujeito(s) à disponibilidade. / Set in vendita separatamente, secondo disponibilità. / Das/Die Set(s) sind separat erhältlich. / Zestaw(y) sprzedawany(e) oddzielnie w zależności od dostępności. / Set(s) apart verkrijgbaar en afhankelijk van beschikbaarheid. / Набор(-ы) продаются отдельно, при наличии. / Sæt sælges separat og så længe lager haves. / Seten säljs separat så länge lagret räcker. / Settet/settene selges separat så langt lageret rekker. / Pakkaus/pakkaukset myydään erikseen, saatavuus voi vaihdella. / Το(α) σετ πωλούνται ξεχωριστά και ανάλογα με τη διαθεσιμότητα. / Setler ayrı olarak satılır ve stoklarla sınırlıdır. / Set (sety) se prodává (prodávají) samostatně dle aktuální nabídky. / Súprava/-y sa predáva(jú) samostatne a podľa dostupnosti. / A készlet(ek) külön kapható(k), az elérhetőség változhat. /

セッ商品は別売りになります。在庫状況は別途ご確認をお願いします。 /
تباع المجموعة أو المجموعات على حدة وتخضع لتوافرها.
每套单独发售，按供货情况决定。

1186 MJ, 1, NL

Ⓟ D781,964, D797,203, D786,984, D834,105

Mattel Canada Inc. Mississauga, Ontario L5R 3W2.
MADE IN CHINA. FABRIQUÉ EN CHINE. FABRICADO NA CHINA. HECHO EN CHINA.
ИЗГОТОВЛЕНО В КИТАЕ. ÇIN'DE ÜRETİLMİŞTİR. صنع في الصين

©2022 MEGA Brands &™ MEGA Brands.
Printed in China / Imprimé en Chine 24D-HLB70-01A

