



**HNG53**  
**DEMO DERBY EXTREME TRICK COURSE**  
**COURSE EXTRÊME DEMO DERBY**

PISTA DE TRUCOS EXTREMOS DEMO DERBY / DEMO DERBY PISTA EXTREMA  
ЭКСТРЕМАЛЬНЫЕ ТРЮКИ DEMO DERBY





**Build**  
**Construisez**

Construye | Constrói  
Bauen | Стройте



**Share | Partagez**

Comparte | Partilha  
Teilen | Делитесь



**Easy-to-follow steps!**

**Des instructions  
faciles à suivre !**

¡Pasos fáciles de seguir!  
Passos fáceis de seguir!  
Einfache Schritte!  
Простые действия!

Devices not included | Appareils non inclus | Dispositivos no incluido | Dispositivos não incluídos | Geräte nicht enthalten | Устройства не входят в комплект

[megaunboxed.com](http://megaunboxed.com)



**BUILDING TOOL**  
**OUTIL DE**  
**CONSTRUCTION**

HERRAMIENTA DE CONSTRUCCIÓN  
BAUWERKZEUG  
FERRAMENTA DE MONTAGEM  
ИНСТРУМЕНТ ДЛЯ КОНСТРУИРОВАНИЯ

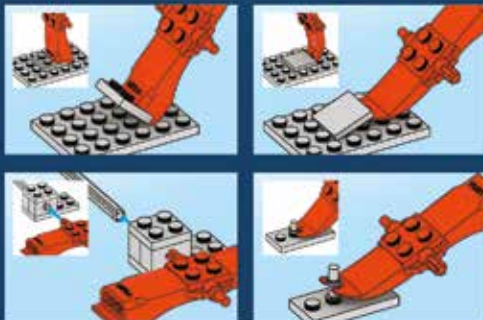



1



2

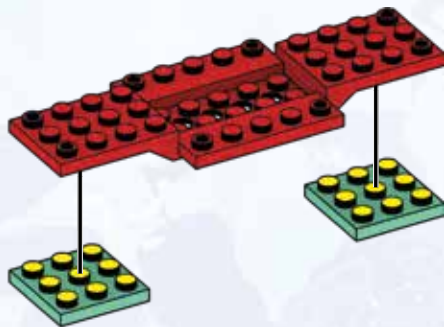
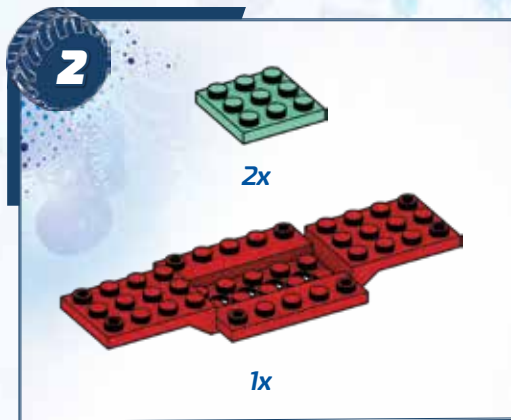

3



1x



1x



1x

4



2x

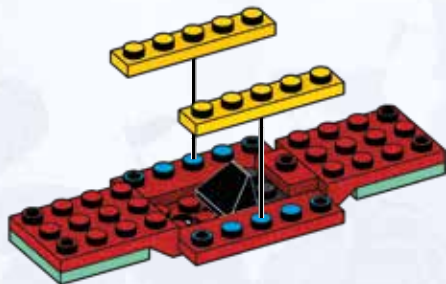
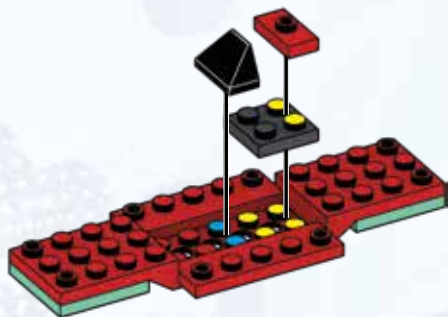

5



1x



1x

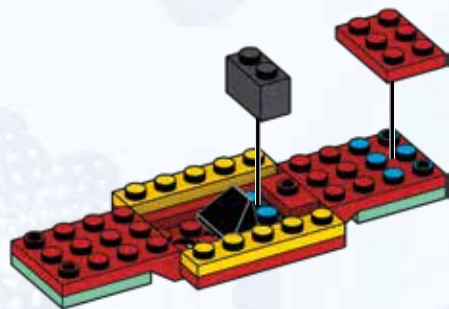

6



2x



1x

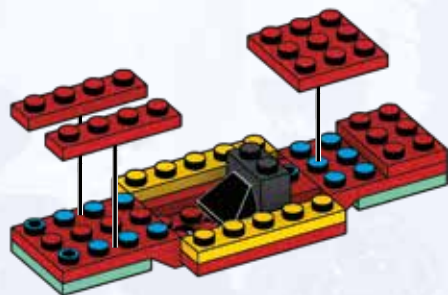

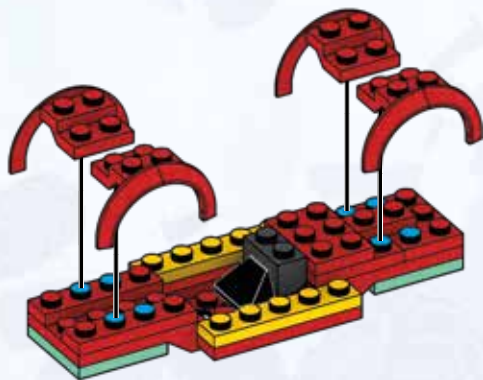
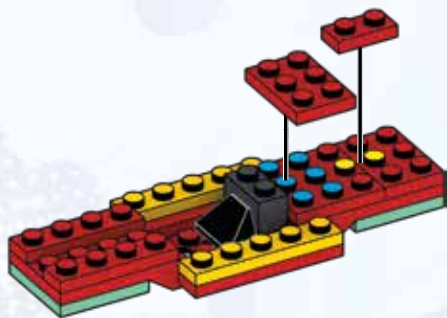
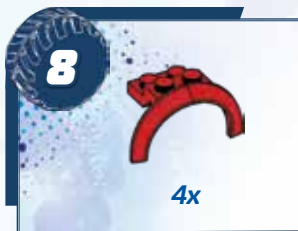
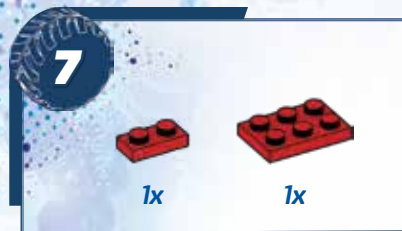

9



2x

10



1x



1x



1x

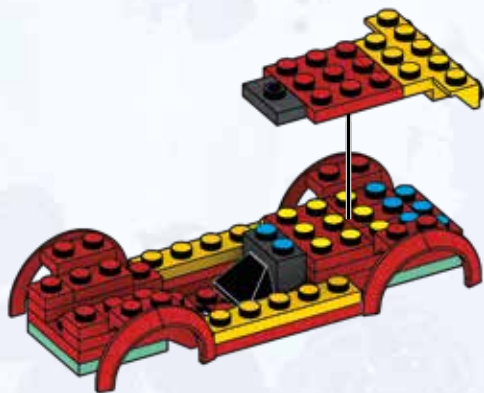
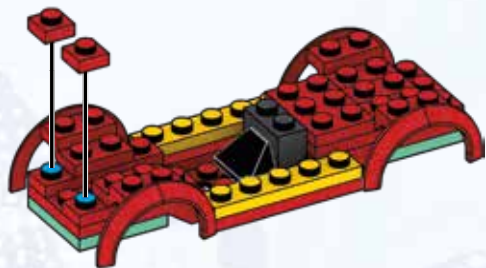

11



1x



1x

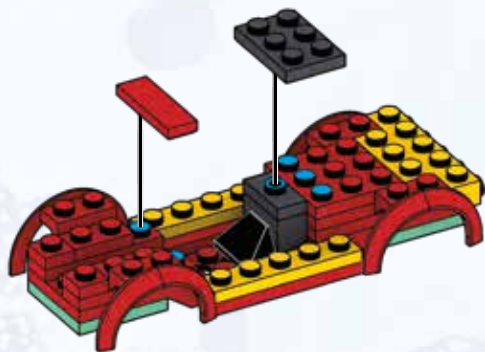

12



1x



1x

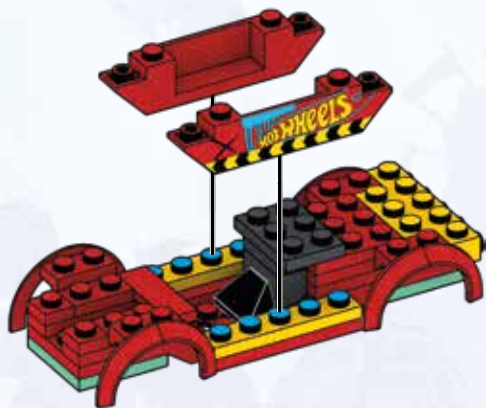



13



1x

1x

14



2x

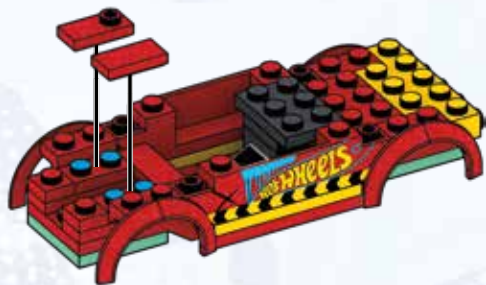

15



1x



1x



1x



1x

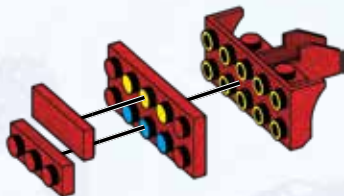

16



2x



1x

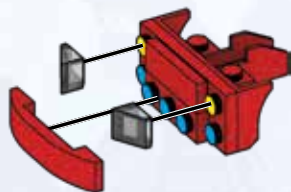

17

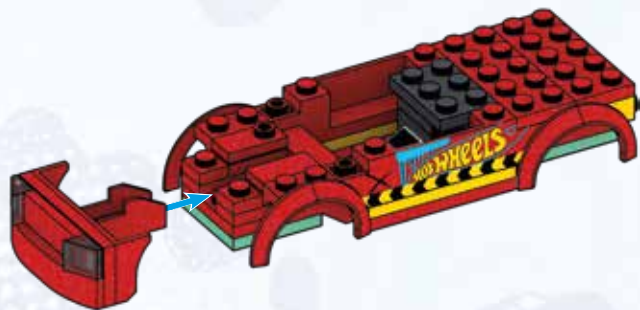

19



1x

20



2x



1x



1x



3x



1x

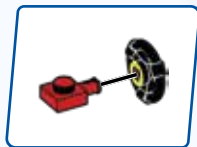

1



2



3

21



22



2x



23



1x



24



2x



1x



1x



25



3x

26



2x



27



2x

2x



28



1x

1x

1x





29



1x



1x

30



2x

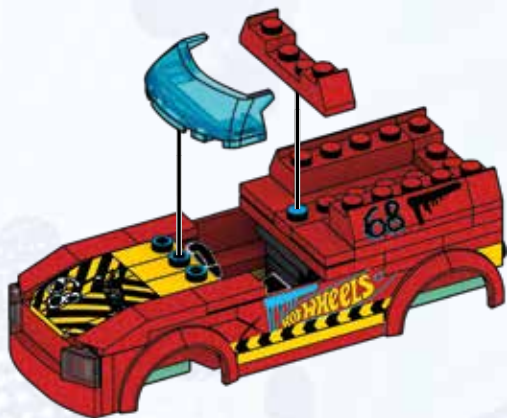

31



1x

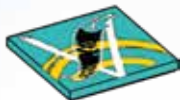

1x



1x



1



2

**32**

2x



1x



1x

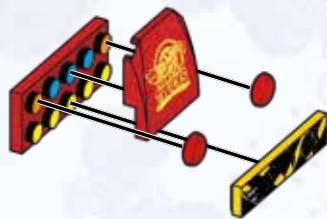

1x

**33**

1



2

34



1x

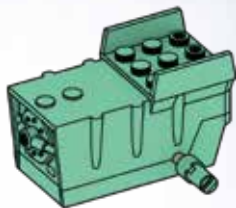

1x

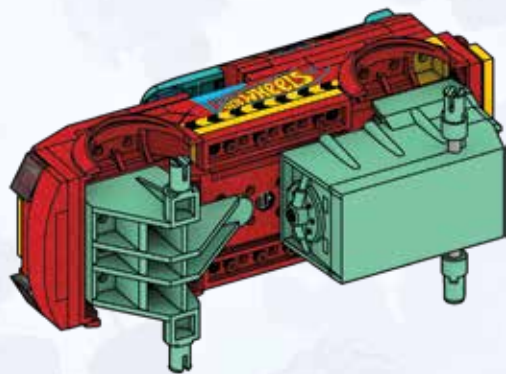
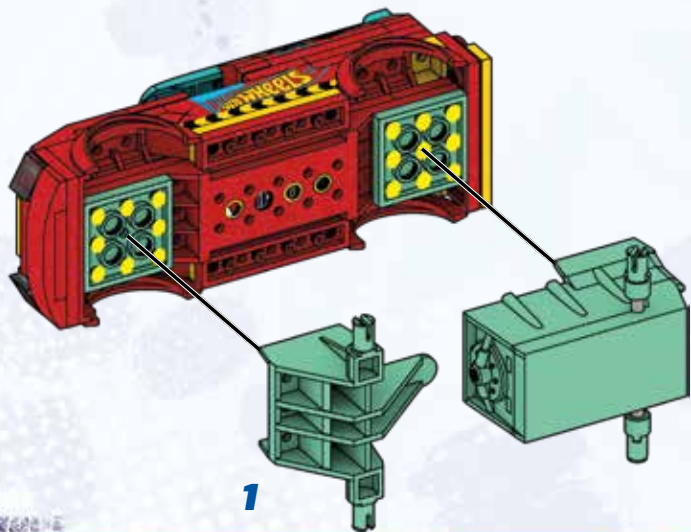



1



2



**SMASH & CRASH™**

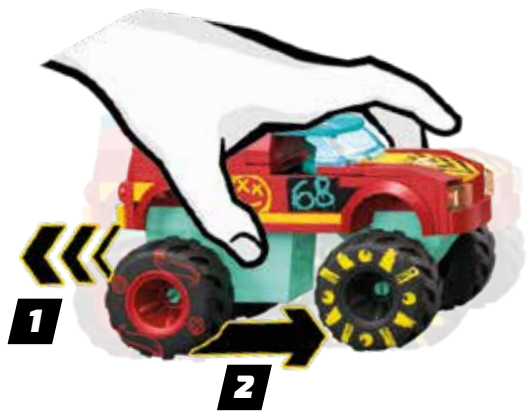

**1**

**PULL BACK AND GO!**

**TIREZ LE VÉHICULE VERS L'ARRIÈRE ET PARTEZ !**

¡HAZLO RODAR HACIA ATRÁS Y SUÉLTALO! • PUXA  
PARA TRÁS PARA ARRANCAR! • ZURÜCKZIEHEN  
UND LOSS GEHT'S! ПОТЯНИ И ЗАПУСТИ!



**2**

**PIECES FLY OFF ON IMPACT**

**LES ÉLÉMENTS VOLENT LORS DE L'IMPACT**

LAS PIEZAS SALEN VOLANDO POR EL IMPACTO  
AS PEÇAS VOAM COM O IMPACTO  
BEIM AUFSCHLAG FLIEGEN TEILE AB  
ДЕТАЛИ ВЫЛЕТАЮТ ПРИ СТОЛКНОВЕНИИ

**SMASH  
&  
CRASH™**



**Rebuild & play**  
**Reconstruire et jouer**

**Reconstruir y jugar**  
**Reconstruir e brincar**  
**Umbauen und spielen**  
**перестроить и играть**

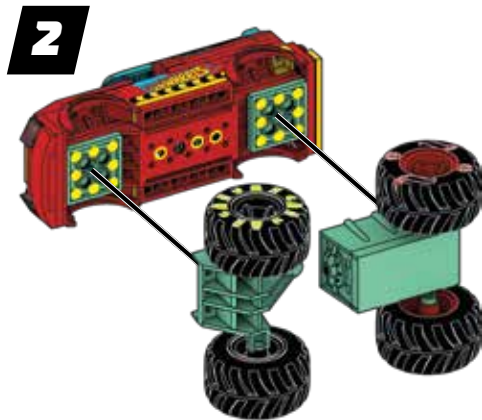

**SMASH & CRASH™**

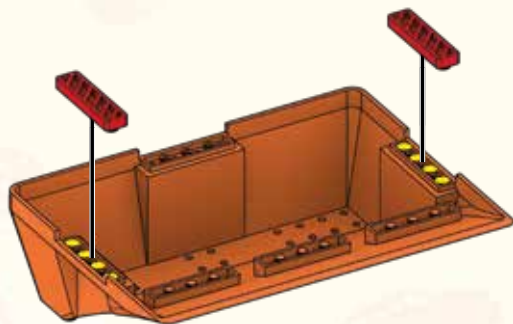

**1**

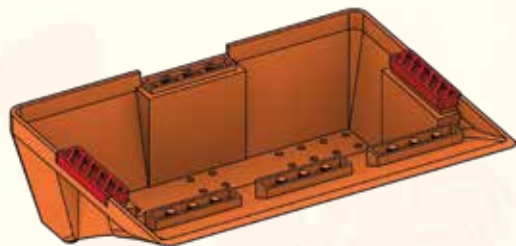

**2**

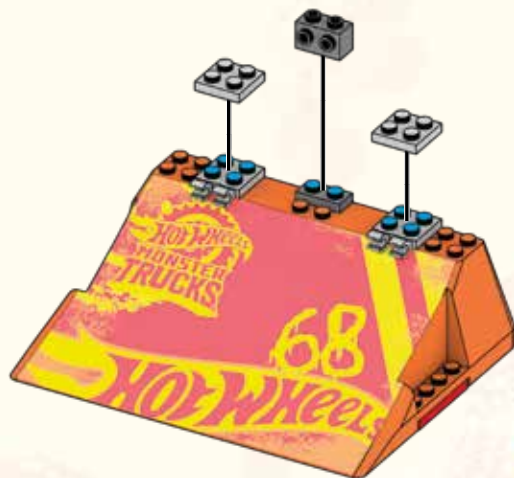
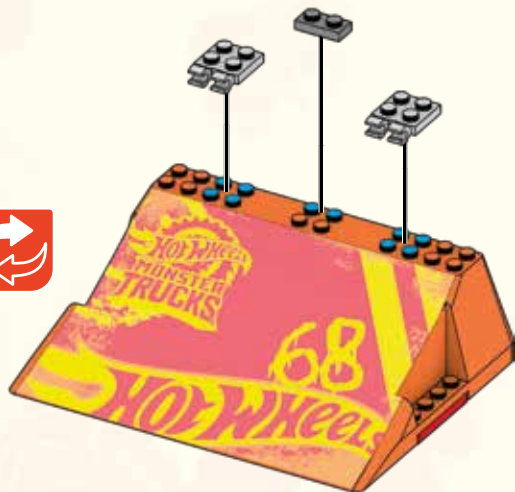

39

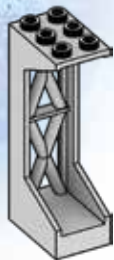

2x

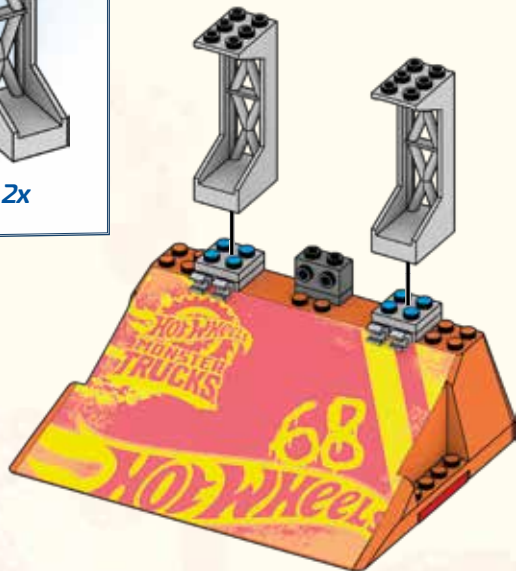

40



2x

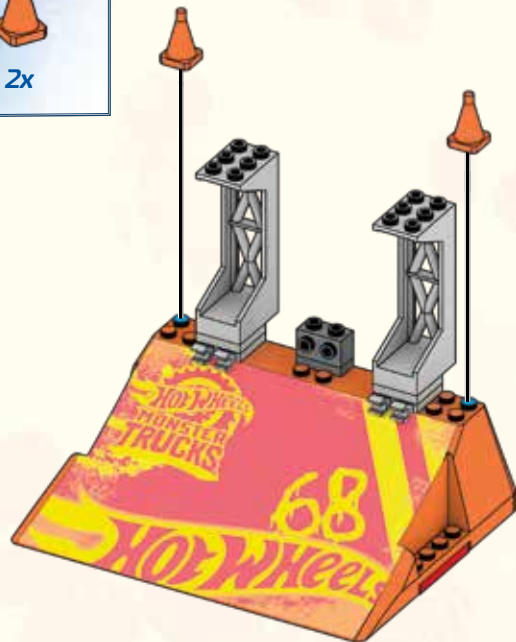

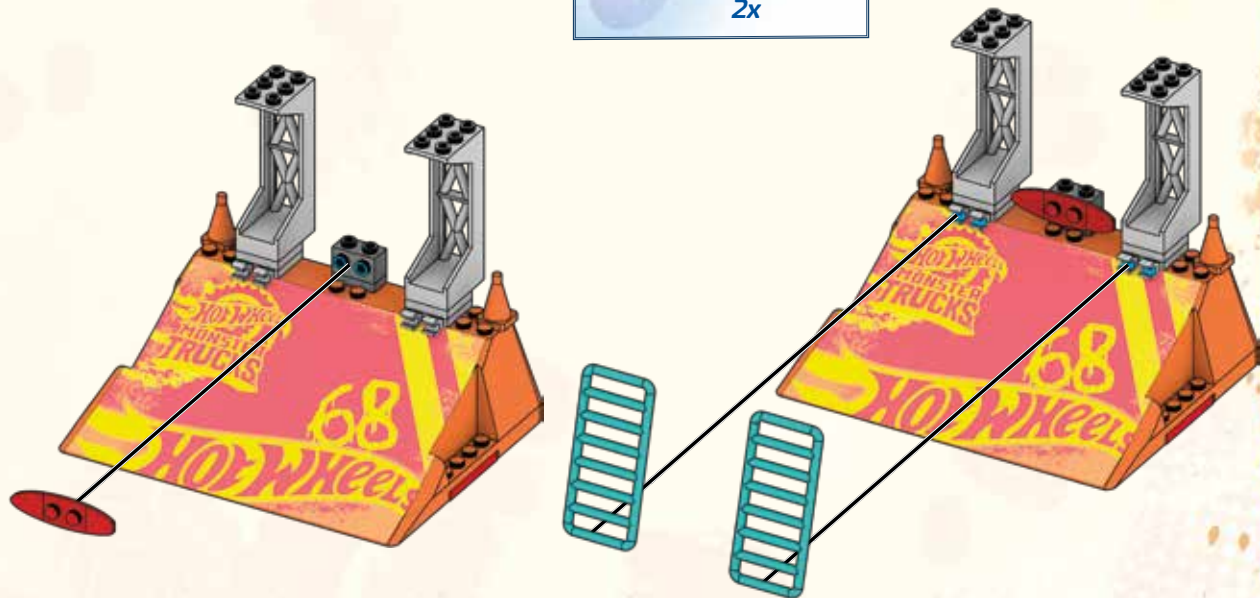
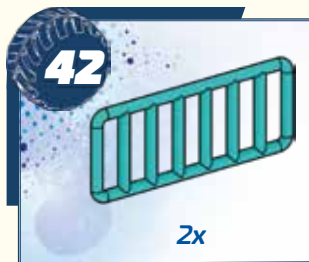
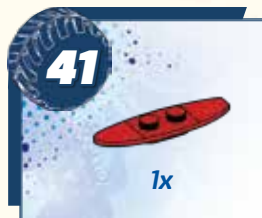

43



1x



1x



1x



44



2x



1x



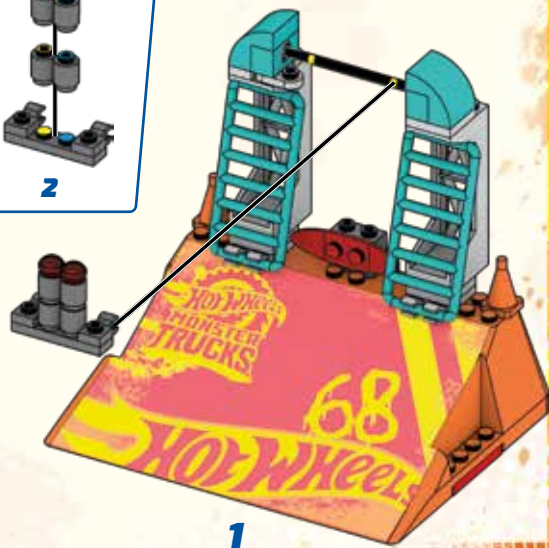
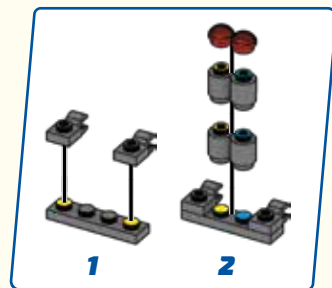
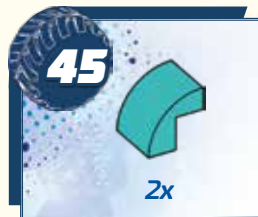



**47**



1x



1x



1x



1x



1x



1x



1x



**1**



**2**



48



1x



1x



1x



1x

49



1



2



50



1x



1



2

51



2x



2x



2x



2x

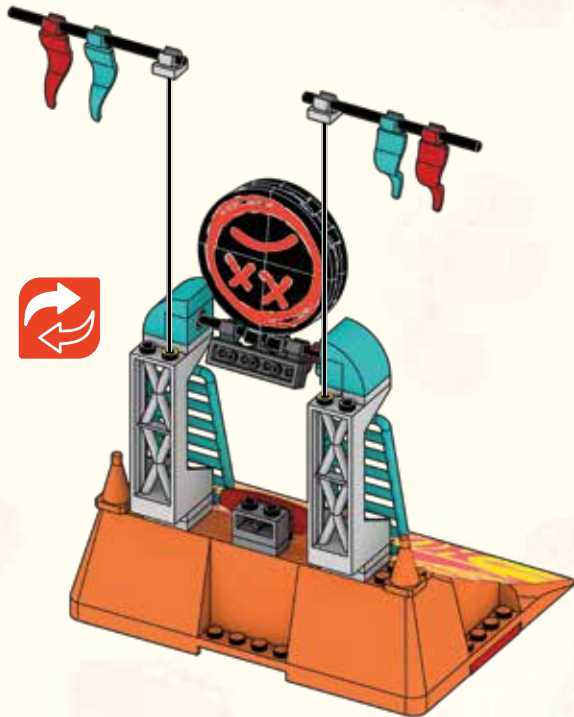
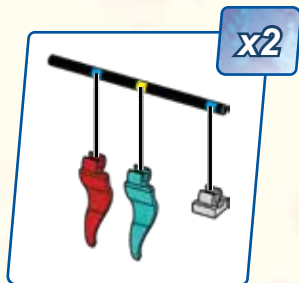

52



1x



1x



1x

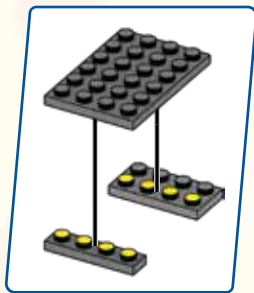

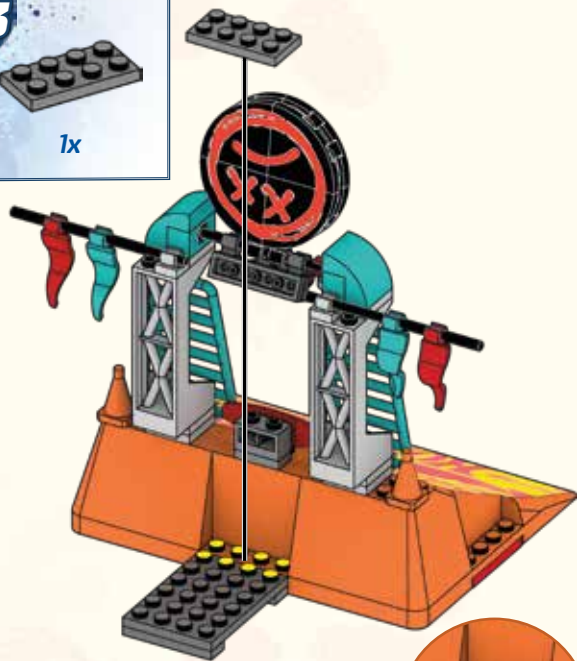
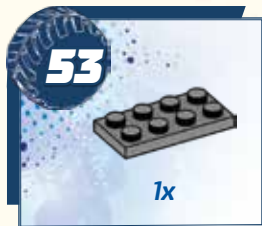



Demo Derby Extreme Trick Course / Course Extrême Demo Derby / Pista de trucos Extremos Demo Derby / Demo Derby PistaExtrema  
Percorso Acrobazie Estreme Demo Derby / Demo Derby Extreme-Stunt Set / Demo Derby Ekstremalna sztuczka / Demo Derby Extrem Lastige Baan  
Εκстремальные трюки Demo Derby / Demo Derby Διαδρομή για Κόλπα / Demo Derby Zorlu Gösteri Parkuru / Demo Derby extrém trükkpálya  
Demo Derby svår stuntbana / Demo Derby Extreme Trick Course / Demo Derby ekstrem stuntbane / Demo Derby Extreme Trick Course مسار الاستعراضات



**1** **PULL BACK AND GO!  
TIREZ LE VÉHICULE VERS  
L'ARRIÈRE ET PARTEZ !**

¡HAZLO RODAR HACIA ATRÁS Y SUÉLTALO!  
PUXA PARA TRÁS PARA ARRANCAR!  
ZURÜCKZIEHEN UND LOSS GEHT'S!  
ПОТЯНИ И ЗАПУСТИ!



**2** **HIT THE RAMP & BARRIER,  
WATCH IT FLIP!  
PERCUTEZ LA RAMPE ET  
LA BARRIÈRE, REGARDEZ-LA  
SE RENVERSER**

GOLPEA LA RAMPA Y LA BARRERA  
MIRA CÓMO DA UNA VUELTAATINGE  
A RAMPA E A BARREIRA  
VÊ O VEÍCULO DAR UMA VOLTA  
GEGEN DIE RAMPE UND DAS HINDERNIS  
FAHRENVERRÜCKTE ÜBERSCHLÄGE  
СТОЛКНИСЬ С РАМПОЙ ИЛИ  
ПРЕПЯТСТВИЕМСМОТРИ, КАК МАШИНКА  
ПЕРЕВОРАЧИВАЕТСЯ



**3** **PIECES FLY OFF on IMPACT  
LES ÉLÉMENTS VOLENT LORS DE L'IMPACT**

LAS PIEZAS SALEN VOLANDO POR EL IMPACTO  
AS PEÇAS VOAM COM O IMPACTO  
BEIM AUFSCHLAG FLIEGEN TEILE AB  
ДЕТАЛИ ВЫЛЕТАЮТ ПРИ СТОЛКНОВЕНИИ

⚠ WARNING: DO NOT AIM AT EYES OR FACE. ONLY USE PROJECTILES SUPPLIED WITH THIS TOY. DO NOT FIRE AT POINT BLANK RANGE.

ADVERTENCIA: NO APUNTAR A LOS OJOS NI A LA CARA. SI ADQUIRIÓ UN MODELO CON PROYECTIL(ES) INCLUIDO(S): UTILIZAR ÚNICAMENTE EL(LOS) PROYECTIL(ES) INCLUIDO(S) EN ESTE JUGUETE. NO DISPARAR A PERSONAS NI ANIMALES. NO DISPARAR A QUEMARROPA.

**ATTENTION** : NE PAS VISER LES YEUX OU LE VISAGE. NE PAS UTILISER D'AUTRES PROJECTILES QUE CEUX FOURNIS AVEC CE JOUET. NE PAS TIRER À BOUT PORTANT.

**ATENÇÃO!**: NÃO APONTAR PARA OS OLHOS E PARA A FACE. NÃO UTILIZAR PROJÉTEIS DIFERENTES DOS PROVIDOS E DOS INDICADOS PELO FABRICANTE DO BRINQUEDO.



Avvertenza: Non mirare agli occhi o al viso. Usare solo i proiettili forniti con il giocattolo. Non sparare a distanza ravvicinata.

Achtung: Nicht auf Augen oder Gesicht zielen. Nur die zu diesem Spielzeug gehörenden Projektile verwenden. Nicht auf Menschen oder Tiere oder aus nächster Nähe zielen.

Ostrzeżenie: Nie celuj w oczy i twarz. Nie strzelaj pociskami innymi niż dostarczone z zabawką. Nie strzelaj z bliska.

Waarschuwing: niet op ogen of gezicht richten. Gebruik uitsluitend de bijgeleverde projectielen. Niet van te dichtbij afschieten.

Предупреждение: Не направляйте в глаза и/или лицо. Используйте только снаряды, входящие в комплект. Не стреляйте со слишком близкого расстояния.

Advarsel: Sigt ikke mod øjne eller ansigt. Brug kun de projektiler, som følger med legetøjet. Skyd ikke direkte på personer eller ting.

Varning: Sikta inte mot ögon eller ansikte. Använd endast projektiler som medföljer leksaken. Fyra inte av på mycket nära håll.

Advarsel: Du må ikke sikte mot øyne eller ansikt. Bruk bare prosjektilene som følger med leken. Ikke skyt på noe på kloss hold.

Varoitus: Älä tähtää silmiin eikä kasvoihin. Käytä ainoastaan tämän tuotteen mukana tulleita ammuksia. Älä ammu lähietäisyydellä.

Προσοχή: Μην στοχεύετε στα μάτια ή στο πρόσωπο. Χρησιμοποιείτε μόνο τα βλήματα που περιλαμβάνονται. Μην στοχεύετε όταν δεν έχετε ορατότητα.

Uyarı: Göze veya yüze nişan almayın. Fırlatmak için yalnızca bu oyuncakla birlikte verilen objeleri kullanın. İnsanlara ve hayvanlara nişan almayın.

Upozornění: Nemířte do očí nebo na obličej. Používejte pouze projektily dodávané s touto hračkou. Nestřílejte z bezprostřední blízkosti.

Upozornenie: Nemierite do očí ani do tváre. Používajte iba strely dodané spolu s touto hračkou. Nestriľajte z bezprostrednej blízkosti.

Figyelmeztetés: Tilos szemre és arcra célozni. Kizárólag a játékhoz mellékelte lövedékeket használja. A játékkal tilos közvetlen közelről löni.

警告：目や顔に向けてのご使用、至近距離での発射はお控えください。このおもちゃの同梱物のみご使用ください。

تحذير: يجب عدم التصويب باتجاه العينين أو الوجه. يجب استخدام المقذوفات المزودة مع هذه اللعبة فقط. يجب عدم الإطلاق من مدى قريب.

**警告**：请勿对着眼睛或脸部发射。仅使用本玩具自带的抛射物。请勿近距离射击。



2x AM08417X  
 2x AM75332X  
 4x AM03328AXW  
 1x AM80546AXW  
 2x AM17127AGY  
 2x AM19999BLG  
 1x AM76029AXW  
 2x AM74415BDG  
 4x AM80144BDG  
 1x AM81383F  
 1x AM16680F

5x AM22501AXW  
 1x AM73758AXW  
 3x AM73758BYE  
 1x AM07590MM  
 1x AM7590AXW  
 3x AM09393AXW  
 1x AM09393BDG  
 1x AM09393BLG  
 1x AM19061F  
 1x AM16972BLG

1x AM09013MM  
 2x AM79877CV  
 1x AM17502BDG  
 1x AM01146F  
 3x AM03773BLG  
 1x AM03773MM  
 2x AM18328BLG  
 1x AM18328F

3x AM80966AXW  
 4x AM01314AXW  
 2x AM16450AXW  
 2x AM16450CV  
 2x AM03772AXW  
 1x AM03772MM  
 1x AM81688AXW  
 1x AM80981AXW  
 1x AM80982AXW

2x AM15065BOR  
 1x AS-HHD18-03  
 1x AS-HNG53-05  
 1x AS-HNG53-07  
 1x AS-HNG53-08  
 1x AS-HNG53-09  
 1x AS-HNG53-10  
 4x AM80972AXW

1x AS-HNG53-11  
 1x AS-HNG53-12  
 1x AS-HNG53-13  
 1x AS-HNG53-14  
 2x AM09593BDG  
 2x AM09593AXW  
 2x AM81640AMC  
 1x AM09921CV  
 1x AM72051AXW

2x AM08481CV  
 2x AM01531AXW  
 2x AM09493BDG  
 1x AS-HHD18-06  
 1x AS-HHD18-07  
 1x AS-HHD18-12  
 2x AM07475BYE  
 2x AM07475AXW  
 7x AM80965AXW



2x  
AM81163ACS



2x  
AM81163AXW



2x  
AM8136AXW



1x  
AM81540AXW



1x  
AM80969BYE



1x  
AM81631AXW



1x  
AS-HHD18-01



1x  
AS-HHD18-02



1x  
FIG-HNG53-A

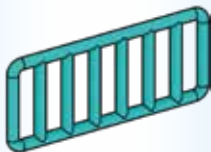

2x  
AM19383CV



1x  
AM81331ACS

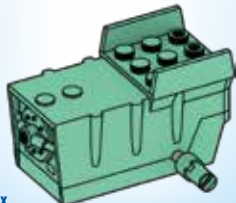

1x  
AS-HNG53-15



1x  
AS-HNG53-01



1x  
AS-HNG53-02



1x  
AS-HNG53-04



1x  
AS-HNG53-03



1x  
AM80975AXW



1x  
AS-HNG53-06

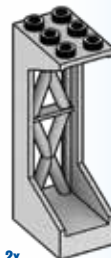

2x  
AM06618BLG

### Missing pieces? • Pièces manquantes?

¿Partes faltantes? • Perdeu peças?  
Fehlen Teile? • Не хватает деталей?

[support.megabrands.com](http://support.megabrands.com)



1x  
AM80538AAV



1x  
AS-HHD18-05



1x  
AS-HHD18-04



2x  
AM18259F



1x  
AM74849F



1x  
AM17055BDG

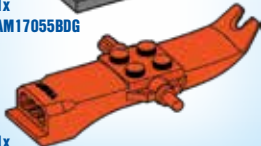

1x  
AM80855MCC

**⚠ WARNING:**  
**CHOKING HAZARD** – Small parts.  
Not for children under 3 years.

**ATTENTION :**  
**DANGER D'ÉTOUFFEMENT –**  
**PETITS ÉLÉMENTS. NE**  
**CONVIENT PAS AUX ENFANTS**  
**DE MOINS DE 36 MOIS.**

**ATENÇÃO:** NÃO INDICADO / NÃO RECOMENDÁVEL PARA CRIANÇAS MENORES DE 3 (TRÊS) ANOS POR CONTER PARTE(S) PEQUENA(S) QUE PODE(M) SER ENGOLIDA(S) OU ASPIRADA(S) PODENDO PROVOCAR ASFIXIA.



**WARNING:** Small parts, **ATTENTION :** PETITS ÉLÉMENTS, **ACHTUNG:** Kleine Teile, **AVVERTENZA:** Piccole parti, **WAARSCHUWING:** Kleine onderdelen, **ADVERTENCIA:** PELIGRO DE ATRAGANTAMIENTO. Juguete no recomendado para menores de 3 años, porque contiene piezas pequeñas que podrían provocar asfixia en caso de ser ingeridas o inhaladas por el/la niño/a, **VARNING:** Små delar, **VAROITUS:** Pieniä osia, **ADVARSEL:** Små dele, **ADVARSEL:** Små deler, **OSTRZEŻENIE:** Małe części, **UPOZORNĚNÍ:** Malé části, **UPOZORNENIE:** Malé časti, **FIGYELMEZTETÉS:** Kis alkatrészek, **ПРЕДУПРЕЖДЕНИЕ:** Мелкие детали, **ΠΡΟΣΕΙΔΟΠΟΙΗΣΗ:** Μικρά κομμάτια, **UYARI:** Küçük parçalar.



**تحذير:** قطع صغيرة.  
警告: のどにつまる危険 小さな部品が含まれています 3歳以下の子供には与えないで下さい。

**警告!** 不适合3岁以下儿童使用。内含小零件。

Mattel Europa B.V., Gondel 1, 1186 MJ Amstelveen, Nederland. Mattel U.K. Limited, The Porter Building, 1 Brunel Way, Slough SL1 1FQ, UK. Mattel France, Parc de la Censeia, 1/3/5 allée des Fleurs, 94260 Fresnes Cedex, N° Cristal 0969 36 99 99 (Numéro non surtaxé) ou www.lesjouetsmattel.fr Mattel Belgium, Trade Mart, Atomiumsquare, Bogota 202 – B 275, 1020 Brussels. Gratis nummer België: 0800 – 16 936 – Gratis nummer Luxemburg: 800 – 22 784 – Gratis nummer Nederland: 0800 – 262 88 35. Deutschland: Mattel GmbH, Solmsstraße 83, D-60486 Frankfurt am Main, Schweiz: Mattel AG, Kirchstrasse 24, CH-3097 Liebefeld, Österreich: Mattel Ges.m.b.H., Campus 21, Liebermannstrasse A01 404, A- 2345 Brunn/Gebrige, Mattel Italy Srl, Via Turati 4, 20121 Milano, Italy. Servizio assistenza clienti: Customerserv.italia@mattel.com - Numero verde 800 11 37 11. Mattel España, S.A, Aribau 200 pl. 9, 08036 Barcelona, cservice.spain@mattel.com Tel.: +34 933 06 79 00 http://www.service.mattel.com/es. Hong Kong: Kids Kingdom Limited, Room 1908-9, Gala Place, 56 Dundas Street, Mongkok, Kowloon, Hong Kong. Customer Care line: (852)2782-0766. Taiwan: Chickabiddy Company Limited, 5/F, No. 186, Section 4, Nanjing East Road, Taipei 10595, Taiwan. Customer Care line: (02)2578-1188. Mainland China: Mattel Barbie (Shanghai) Trading Co., Ltd. Units 4701-4711, 47F, 2 Grand Gateway, 3 Hong Qiao Road, Shanghai, 200030, P.R.C. Customer Care line: 400-819-8658. Diimpport & Diedarkan Oleh: Mattel Continental Asia Sdn Bhd, Level 19, Tower 3, Avenue 7, No. 8 Jalan Kerinchi, Bangsar South, 59200 Kuala Lumpur, Malaysia. Mattel South Africa (PTY) LTD, Office 10213, 30 Melrose Boulevard, Johannesburg 2196. Dystrybutor: Mattel Poland Sp. z o.o., Warsaw Trade Tower 34 p., ul. Chłodna 51, 00-867 Warszawa. Mattel Australia Pty. Ltd., 658 Church St., Richmond, Victoria, 3121. Consumer Advisory Service - 1300 135 312. Mattel AEBE, Εβδούρου Μοκρικού 1, Κηφισία Κ-2, ΤΚ 17561, Πολυάτο Φάληρα, Mattel Oyuncakçılık Tic. Ltd. Şti. Çeremköy Mah., Umut Sokak No: 10 - 12, Quick Tower kat:2 içkari no:15 Atasehir 34752, İstanbul, Türkiye. Tel: 0216 570 75 00. Импортёр Уполномоченная организация: ООО "МАТТЕЛ" Российская Федерация, 105120 Москва, 2-й Сыроматинский переулок,1: +7 495 287 79 39, Центр Czech Republic s.r.o., The Forum, Václavské nám. 19, 11000 Praha1, Mattel, 333 Continental Boulevard, El Segundo, CA 90245, USA. Consumer Services: 1-800-465-MEGA (6342). Mattel Canada Inc., Mississauga, Ontario L5R 3W2. Consumer Services: You may call us free at / Composez sans frais le 1-800-524-8697. Importado y distribuido por Mattel de México, S.A. de C.V., Miguel de Cervantes Saavedra N.º 193, Pisos 10 y 11, Col. Granada, Alcaldía Miguel Hidalgo, C.P. 11520, México, Ciudad de México. R.F.C. MME-920701-NB3. Tels: 59-05-51-00 Ext. 5206 ó 01-800-463-59-89. Mattel Chile, S.A., Avenida Américo Vespucio 501-B, Quilicura, Santiago. Tel: 1230-020-6213. Servicio al consumidor Venezuela: Tel: 0-800-100-9123. Mattel Argentina, S.A., Av. Libertador 1000, Piso 11 – Oficinas 109 y 111, Vicente López – Prov. Buenos Aires. Tel: 0800-666-3373. Mattel Colombia, S.A., Calle 123#7-07 P5, Bogotá. Tel: 01800-710-2069. Mattel Perú, S.A., Av. Juan de Arona # 151, Centro Empresarial Juan de Arona, Torre C, Piso 7, Oficina 704, San Isidro, Lima 27, Perú. RUC: 20425853865. Reg. Importador: 02350-12-JUE-DIGESA. Tel: 0800-54744. E-mail Latinoamericana: servicioclientes@mattel.com. Mattel do Brasil Ltda.- CNPJ : 54.558.002/0001-20 - Rua Verbo Divino, 1488 - 2º. Andar - 04719-904 - Chácara Santo Antônio - São Paulo - SP - Brasil. Serviço de Atendimento ao Consumidor: fone 0800 575 0780. E-mail: sac.matteldobrazil@mattel.com

# BUILD YOUR WAY CONSTRUIS TON UNIVERS



HNG52



HKF87



HKF89



**Crea tu camino | Constrói à tua maneira  
Bauen, wie es dir gefällt! | Построй свой гонок**

Set(s) sold separately and subject to availability. / Ensemble(s) vendu(s) séparément. Certains produits peuvent ne pas être commercialisés. / Se vende(n) por separado y está(n) sujeto(s) a disponibilidad. / Conjunto(s) vendido(s) em separado e sujeito(s) à disponibilidade. / Set in vendita separatamente, secondo disponibilità. / Das/Die Set(s) sind separat erhältlich. / Zestaw(y) sprzedawany(e) oddzielnie w zależności od dostępności. / Set(s) apart verkrijgbaar en afhankelijk van beschikbaarheid. / Набор(-ы) продаются отдельно, при наличии. / Sæt sælges separat og så længe lager haves. / Seten säljs separat så länge lagret räcker. / Settet/settene selges separat så langt lageret rekker. / Pakkaus/pakkaukset myydään erikseen, saatavuus voi vaihdella. / Το(α) σετ πωλούνται ξεχωριστά και ανάλογα με τη διαθεσιμότητα. / Setler ayrı olarak satılır ve stoklarla sınırlıdır. / Set (sety) se prodává (prodávají) samostatně dle aktuální nabídky. / Súprava/-y sa predáva(jú) samostatne a podľa dostupnosti. / セット商品は別売りになります。在庫状況は別途ご確認をお願いします。 / تباع المجموعه أو المجموعات على حدة وتخصع لتوافرها. / 每套单独发售，按供货情况决定。

HOT WHEELS™ and associated trademarks and trade dress are owned by, and used under license from, Mattel. ©2022 Mattel. ©2022 MEGA Brands &™ MEGA Brands. Printed in China / Imprimé en Chine AD-HNG53-01B

1186 MJ, 1, NL P D714,887



Mattel Canada Inc. Mississauga, Ontario L5R 3W2.  
MADE IN CHINA. FABRIQUÉ EN CHINE. FABRICADO NA CHINA. HECHO EN CHINA.  
ИЗГОТОВЛЕНО В КИТАЕ. ÇIN'DE ÜRETİLMİŞTİR. صنع في الصين

