



Please keep this instruction sheet for future reference,
as it contains important information.

Requires four "D" (LR20) **alkaline** batteries for mobile
operation and two "AAA" (LR03) **alkaline** batteries for
remote operation (batteries not included).

Adult assembly is required.

Tool required for assembly: Phillips screwdriver (not included).

Consumer Information



WARNING

Prevent Entanglement Injury

- Keep out of baby's reach.
- Remove mobile portion of product from crib or playpen when baby begins to push up on hands and knees.
- This product may not attach to all crib designs. Do not add additional strings or straps to attach to crib or playpen.

- The mobile portion of this product may be used from birth until 5 months.
- The base portion of this product may be used from birth until 36 months.
- A crib mobile is intended for visual stimulation and is not to be grasped by a child.
- Always attach with all provided fasteners tightly to a crib or playpen according to the instructions. Check frequently.
- Wipe this toy with a clean cloth dampened with a mild soap and water solution. Do not immerse this toy. The soft toys are surface washable.
- This toy has no consumer serviceable parts. Do not take this toy apart.

Battery Safety Information

In exceptional circumstances, batteries may leak fluids that can cause a chemical burn injury or ruin your product. To avoid battery leakage:

- Do not mix old and new batteries or batteries of different types: alkaline, standard (carbon-zinc) or rechargeable (nickel-cadmium).
- Insert batteries as indicated inside the battery compartment.
- Remove batteries during long periods of non-use. Always remove exhausted batteries from the product. Dispose of batteries safely. Do not dispose of product in a fire. The batteries inside may explode or leak.
- Never short-circuit the battery terminals.
- Use only batteries of the same or equivalent type, as recommended.
- Do not charge non-rechargeable batteries.
- Remove rechargeable batteries from the product before charging.
- If removable, rechargeable batteries are used, they are only to be charged under adult supervision.

Parts

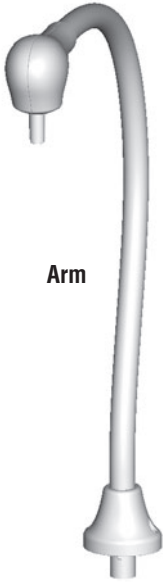

Arm

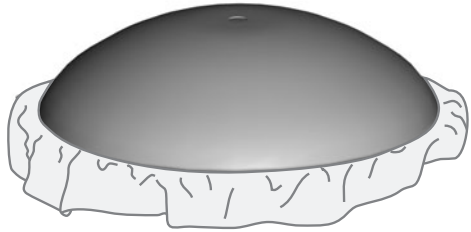

Canopy



4 Soft Toys



Crib Adaptor



Remote

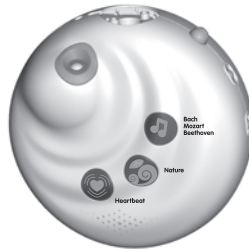

Base



**Retainer
(2 Pieces)**

Note: All of the screws used to assemble this toy are attached to the product. Follow these instructions carefully to fully secure the screws. Tighten and loosen all screws with a Phillips screwdriver. Do not over-tighten the screws.

Battery Installation

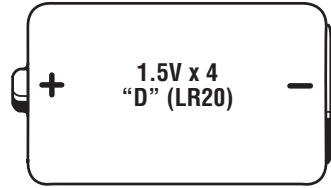
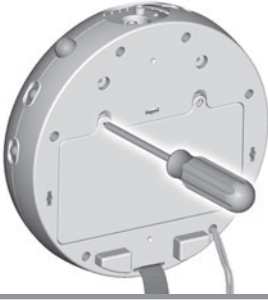

We recommend using **alkaline** batteries for longer battery life.

Mobile Base

- Loosen the screws in the battery compartment door with a Phillips screwdriver. Remove the battery compartment door.
- Insert four "D" (LR20) **alkaline** batteries.
- Replace the battery compartment door and tighten the screws.

IMPORTANT! Under normal use conditions, the batteries in the mobile base will require replacement more often than the batteries in the remote. When sounds or lights become faint or stop, it's time for an adult to change the batteries.



We recommend using **alkaline** batteries for longer battery life.

Remote

- Loosen the screw in the battery compartment door with a Phillips screwdriver. Remove the battery compartment door.
- Insert two "AAA" (LR03) **alkaline** batteries.
- Replace the battery compartment door and tighten the screw.
- If this product begins to operate erratically, you may need to reset the electronics. Slide the power/volume switch on the mobile base off and then back on. Remove the batteries from the remote and replace them.



- Protect the environment by not disposing of this product with household waste (2002/96/EC). Check your local authority for recycling advice and facilities (Europe only).

Assembly

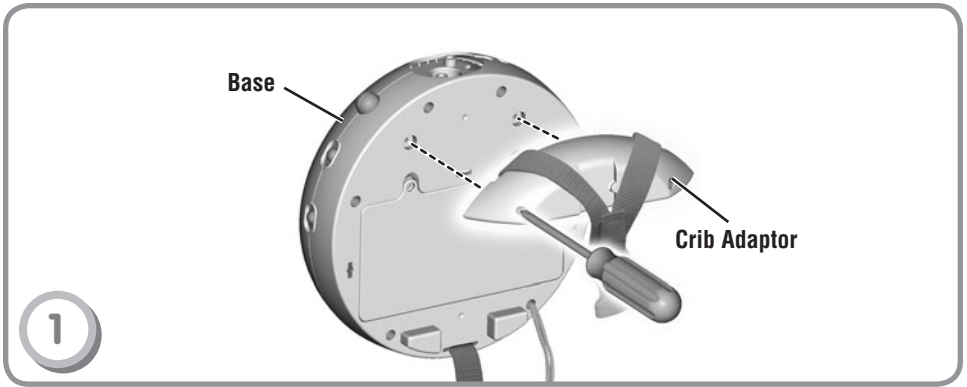

- Fit the crib adaptor to the base and tighten the screws.

IMPORTANT! Make sure the straps are over the **top** of the crib adaptor.

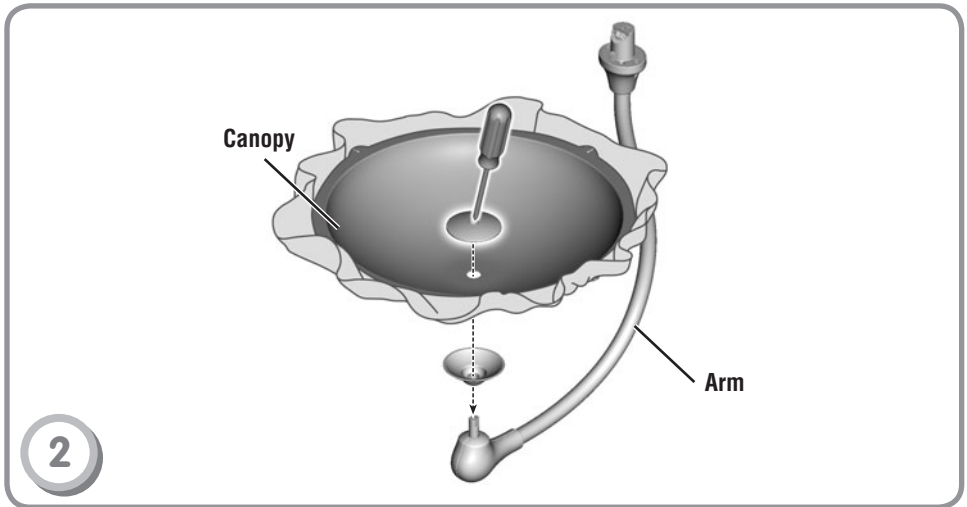

- First, fit the top retainer piece onto the end of the arm.
- Next, fit the canopy onto top retainer piece.
- Then, fit the bottom retainer piece onto the canopy and tighten the screw.

Assembly

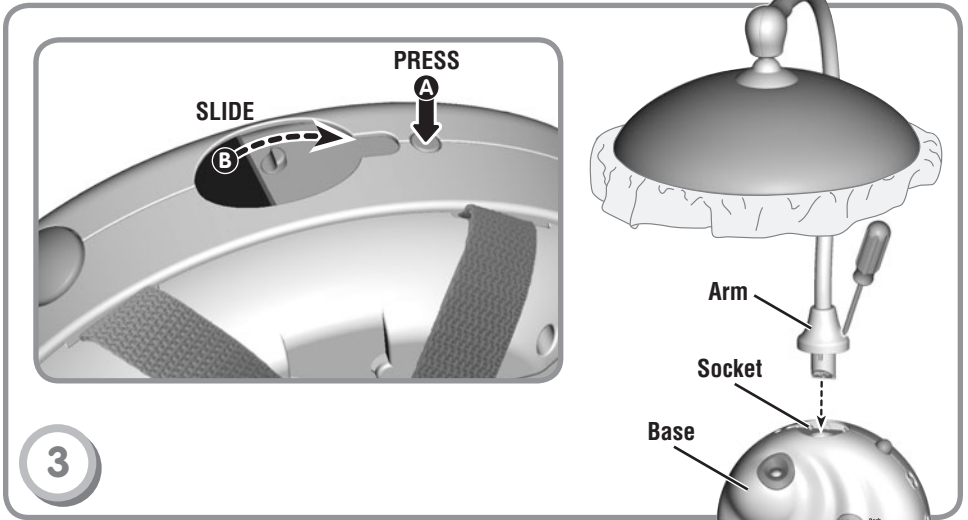

3

- First, press the button on the mobile base, next to the socket **A** and then slide the socket door open **B**.
- Fit the arm into the socket in the base and tighten the screws.

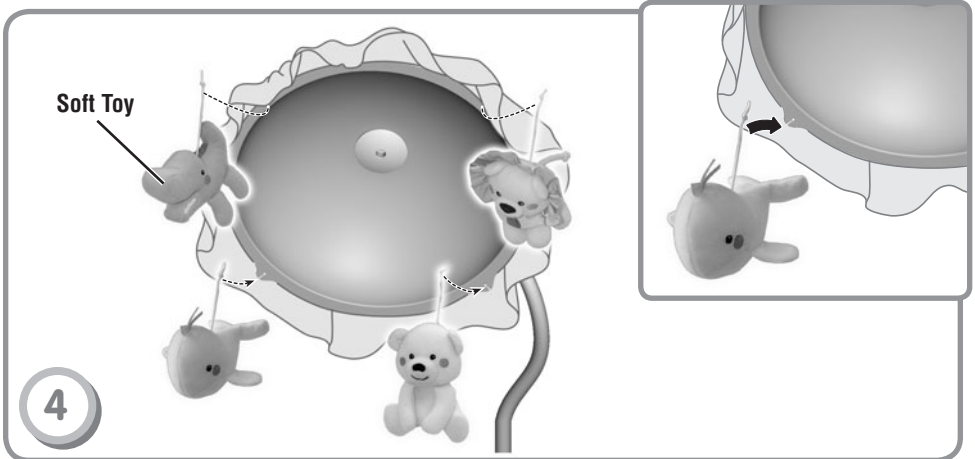

4

- Fit the string on a soft toy through the slot in the canopy. Pull down gently on the soft toy to secure the string in the large leaf spoke.
- Repeat this procedure to attach the remaining soft toys to the canopy.

Crib Attachment

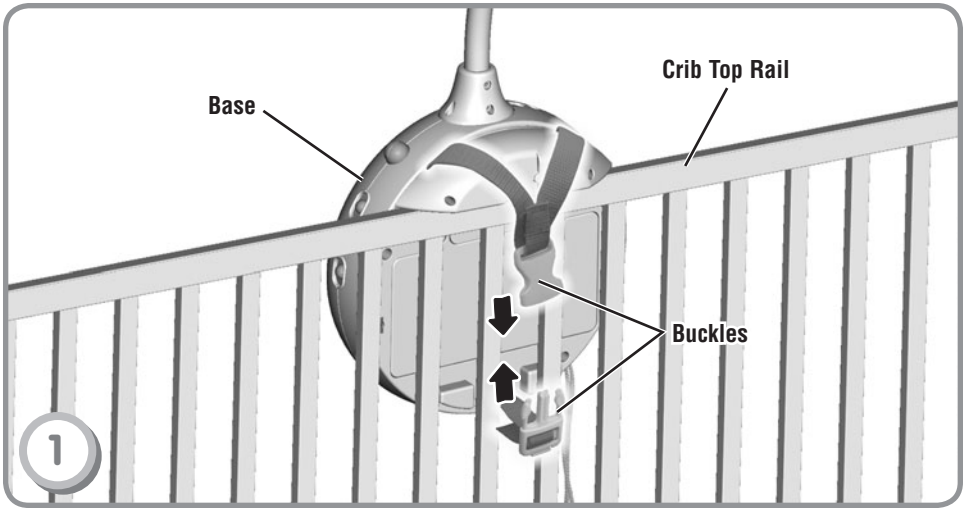

- Position the base so that the decorated side faces the inside of the crib.
- Fit the base onto the crib top rail.
- Make sure the top strap is hanging over the crib top rail. Pull the bottom strap through the crib rails.
- Buckle the straps. Make sure you hear a “click”.

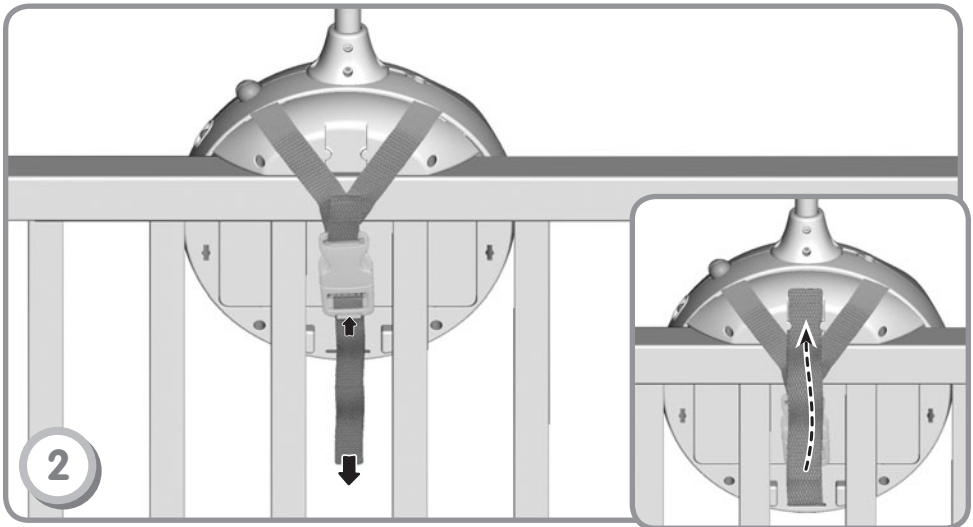

- Make sure the straps are tightened securely around the crib rail.
- While pushing the tab at the bottom of the buckle, pull the free end of the strap to tighten on the rail.

Hint: You can secure the free end of the strap to the base.

- To loosen the strap for removal, simply pull the buckle down.

Crib Attachment

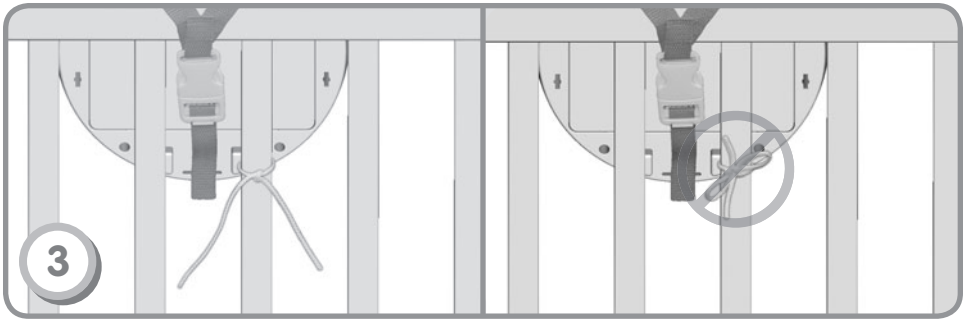

- Tie the base strings to a crib spindle.

Note: It is better to tie the strings in a knot than a bow, since a bow may be easily untied.

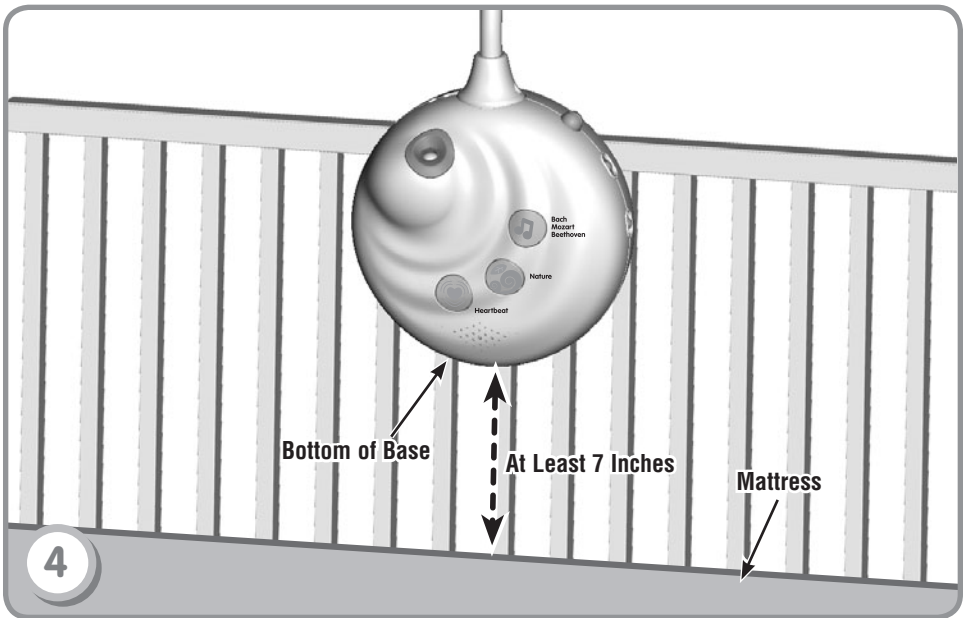

- If the distance between the base and the mattress is less than 7 inches, lower the crib mattress.

Use

IMPORTANT!

- In the unlikely event that use of the remote interferes with normal use of other remote controlled equipment, such as televisions, stereos, or use of other electronic or battery powered appliances interfere with operation of the mobile, do not use both appliances at the same time.
- For best performance between the mobile and the remote, avoid using the remote in areas of bright light. In bright natural or artificial light, you may notice loss of range. Move the mobile or otherwise reduce the amount of light to improve performance.

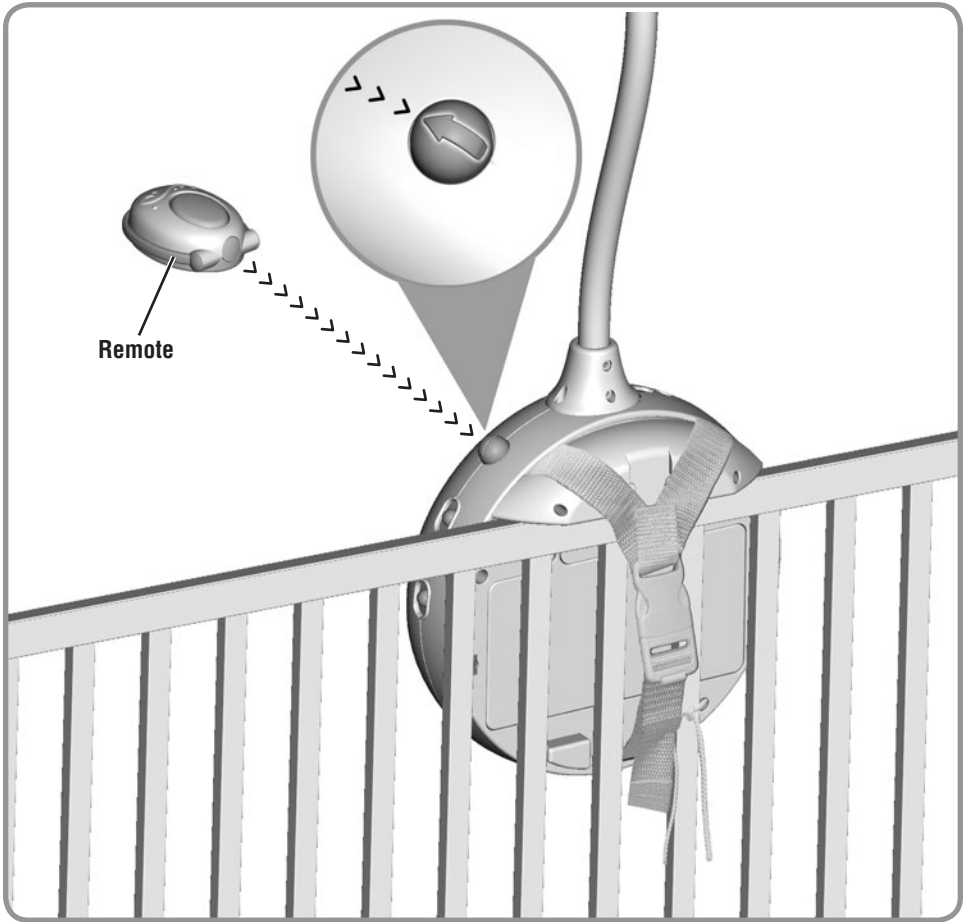

- When using the remote, make sure that the arrow on the mobile base is pointing towards the transmitter window on the remote. **For best results make sure the path between the transmitter window on the remote and the mobile base are in a direct line and free of obstacles. Position the mobile base so that the arrow points to the area from which you're most likely to use the remote.** For example, if you'll most often be using the remote from the doorway of the nursery, make sure the arrow on the mobile base is pointing towards the doorway and the path between the mobile base and doorway is free from obstructions.

Use

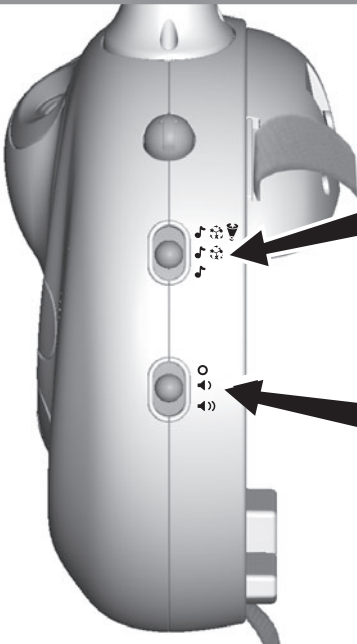

Projector/Sound Switch

Slide the switch to:

- turns on sounds, mobile and projector
- turns on sounds and mobile
- turns on sounds only

Power/Volume Switch

- Slide the switch to on with low volume or on with high volume . When finished using the product, slide the switch off .

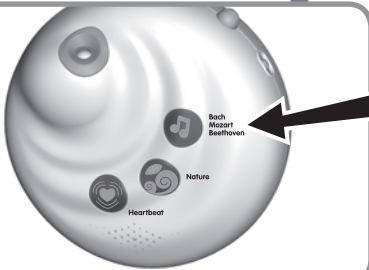

Music or Sound Select Buttons

Press a music or sound button on the front of the mobile base:

- for Bach, Beethoven and Mozart
- for nature sounds
- for heartbeat sounds

Convert to Music Box

Remove the mobile and use as a music box with a projection show!

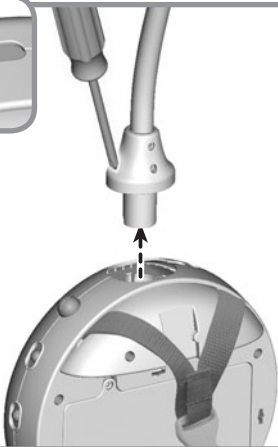

- Loosen both screws in the arm near the mobile base. Lift and remove the arm.
- Close the socket door on top of the mobile base.
IMPORTANT! The socket door must be closed for sound and projection operation. If sounds or lights are not working, make sure the door is **completely** closed.
- Store the mobile in a safe place for future use.

Consumer Information



CONSUMER ASSISTANCE

Call toll free: 1-800-432-5437 (US & Canada only)
M-F 9AM to 7PM / SAT 11AM to 5PM (EST)

 **service.fisher-price.com**

Write to us at: Fisher-Price® Consumer Relations,
636 Girard Avenue, East Aurora, New York 14052.

Hearing-impaired consumers using TTY/TDD equipment,
please call 1-800-382-7470.

For countries outside the United States:

Canada: Mattel Canada Inc., 6155 Freemont Blvd.,
Mississauga, Ontario L5R 3W2; www.service.mattel.com.

Great Britain: Mattel UK Ltd, Vanwall Business Park,
Maidenhead SL6 4UB. Helpline: 01628 500303,
www.service.mattel.com/uk

Australia: Mattel Australia Pty. Ltd., 658 Church Street,
Locked Bag #870, Richmond, Victoria 3121 Australia.
Consumer Advisory Service 1300 135 312.

New Zealand: 16-18 William Pickering Drive,
Albany 1331, Auckland.

Asia: Mattel East Asia Ltd, Room 1106, South Tower,
World Finance Centre, Harbour City, Tsimshatsui, HK, China.

FCC Statement (United States Only)

This equipment has been tested and found to comply with the limits for a Class B digital device, pursuant to Part 15 of the FCC Rules. These limits are designed to provide reasonable protection against harmful interference in a residential installation. This equipment generates, uses and can radiate radio frequency energy and, if not installed and used in accordance with the instructions, may cause harmful interference to radio communications. However, there is no guarantee that interference will not occur in a particular installation. If this equipment does cause harmful interference to radio or television reception, which can be determined by turning the equipment off and on, the user is encouraged to try to correct the interference by one or more of the following measures:

- Reorient or relocate the receiving antenna.
- Increase the separation between the equipment and receiver.
- Consult the dealer or an experienced radio/TV technician for help.

Note: Changes or modifications not expressly approved by the manufacturer responsible for compliance could void the user's authority to operate the equipment.

This device complies with Part 15 of the FCC Rules.

Operation is subject to the following two conditions: (1) this device may not cause harmful interference and (2) this device must accept any interference received, including interference that may cause undesired operation.

ICES-003

This Class B digital apparatus complies with Canadian ICES-003.

Operation is subject to the following two conditions: (1) this device may not cause harmful interference and (2) this device must accept any interference received, including interference that may cause undesired operation.

NMB-003

Cet appareil numérique de la classe B est conforme à la norme NMB-003 du Canada.

L'utilisation de ce dispositif est autorisée seulement aux conditions suivantes: (1) il ne doit pas produire de brouillage et (2) l'utilisateur du dispositif doit être prêt à accepter tout brouillage radioélectrique reçu, même si ce brouillage est susceptible de compromettre le fonctionnement du dispositif.