

**Kid.
Tough**
digital camera



Fisher-Price

www.fisher-price.com

Table of Contents

Getting Started	
Introduction	3
Tips for Better Images	4
Features	5
Specifications	8
Setting Up Your Camera	
Battery Safety Information	9
Battery Installation	10
Using Your Camera	
Turning the Camera On and Off	12
Taking a Picture	13
Using the Flash	14
Reviewing or Deleting Pictures	15
Changing Picture Resolution	17
Transferring Pictures to Your Computer	
System Requirements	18
Connecting Your Camera to Your Computer	19
Disconnecting Your Camera	20
Consumer Information	
Troubleshooting	21
FCC Statement	23

Introduction

- Please keep this instruction booklet for future reference, as it contains important information.
- Requires four “AAA” (LR03) **alkaline** batteries (not included).
- Adult assembly is required for battery installation. Tool required for battery installation: Phillips or slotted screwdriver (not included).
- When your camera is connected to your computer, you can delete or copy pictures by accessing your camera as a removable storage device.
- Type - Equivalent to IEC Standard publication 529 IPX7.
- The toy is not to be connected to more than the recommended number of power supplies.
- Keep the camera away from direct sunlight and excessive heat.
- Wipe the camera with a soft, clean cloth.
- This camera has no consumer serviceable parts. Please do not take this toy apart.
- Your camera may appear different than the camera shown in the photographs.

ICES-003

This Class B digital apparatus complies with Canadian ICES-003. Operation is subject to the following two conditions: (1) this device may not cause harmful interference and (2) this device must accept any interference received, including interference that may cause undesired operation.

NMB-003

Cet appareil numérique de la classe B est conforme à la norme NMB-003 du Canada. L'utilisation de ce dispositif est autorisée seulement aux conditions suivantes: (1) il ne doit pas produire de brouillage et (2) l'utilisateur du dispositif doit être prêt à accepter tout brouillage radioélectrique reçu, même si ce brouillage est susceptible de compromettre le fonctionnement du dispositif.

Tips for Better Images!

Before your child uses the camera independently, we recommend that you first thoroughly read these instructions. Explain to your child how to use the camera and then practice taking pictures with your child.

1. Use Bright Light Indoors

Make sure there is a bright light source when taking indoor pictures. The light source (sun, lamp or window) should be above or facing your picture subject. Do not place your picture subject in front of the light source since the picture subject will look dark in your photo.

2. Hold Still

Make sure the picture taker and the picture subject are not moving. Also be sure your child holds the camera with two hands.

3. Proper Distance

Center the picture subject on the LCD screen. The picture subject should be no closer than 4 feet (1.2 m) from camera. For flash pictures, make sure your picture subject is no further than 7.5 feet (2.2 m) away.

Features

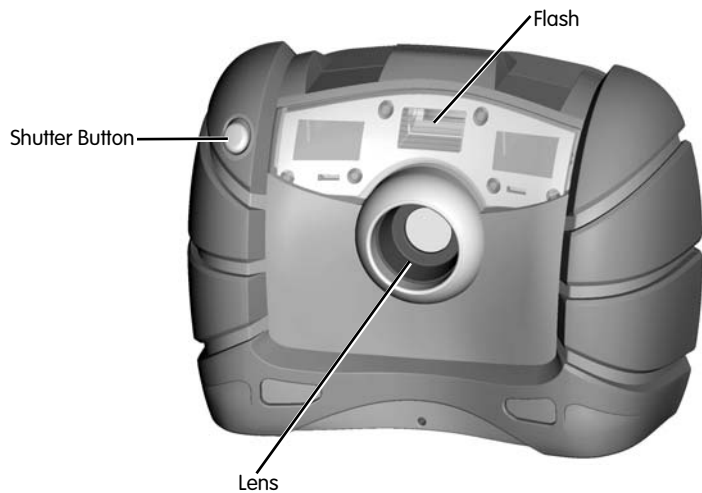

Front View

Features

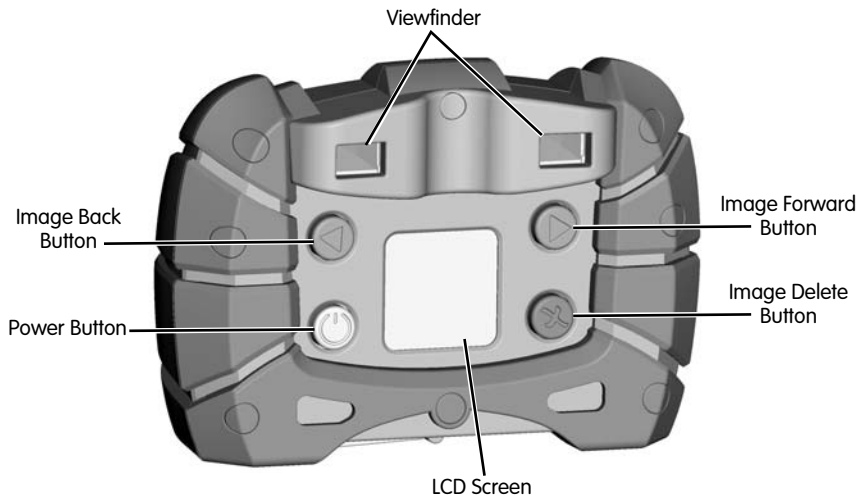

Back View

Features

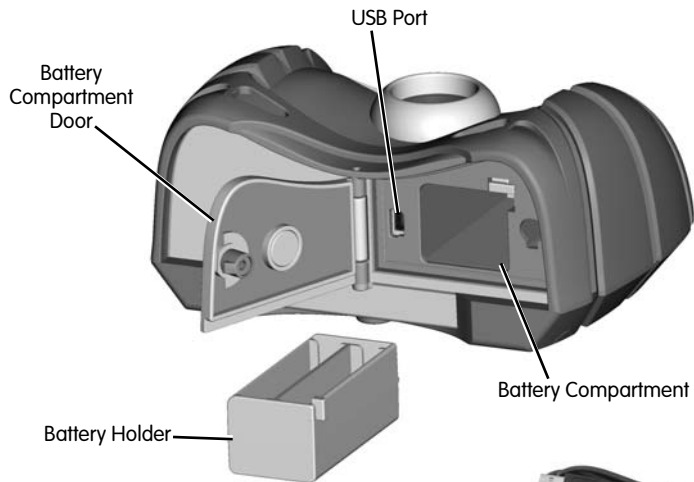

Bottom View



USB Cable
(This is not a toy.)

Specifications

Picture Resolution	640 x 480 (standard resolution setting) or interpolated 1.3 megapixels (high resolution setting).
Internal Memory	64 MB SDRAM approximately 540 pictures (standard resolution setting) or approximately 165 pictures (high resolution setting).
Lens	4.8 mm, $f = 2.6$
Focus Range	4 ft. (1.2 m) - infinity
LCD Screen	1.6" color LCD preview
Connectivity	USB (version 1.1 or higher)
Batteries	4 "AAA" (LR03) alkaline batteries
Flash Range	4 ft. - 7.5 ft. (1.2 m - 2.2 m)
Camera Dimensions	W - 5.375" (13.7 cm) x D - 2.75" (7 cm) x H - 4" (10.2 cm)
Camera Weight	10.5 oz. (298 g) (without batteries)

Battery Safety Information

In exceptional circumstances, batteries may leak fluids that can cause a chemical burn injury or ruin your toy. To avoid battery leakage:

- Do not mix old and new batteries or batteries of different types: alkaline, standard (carbon-zinc) or rechargeable (nickel-cadmium).
- Insert batteries as indicated inside the battery compartment.
- Remove batteries during long periods of non-use. Always remove exhausted batteries from the toy. Dispose of batteries safely. Do not dispose of this product in a fire. The batteries inside may explode or leak.
- Never short-circuit the battery terminals.
- Use only batteries of the same or equivalent type, as recommended.
- Do not charge non-rechargeable batteries.
- Remove rechargeable batteries from the toy before charging.
- If removable, rechargeable batteries are used, they are only to be charged under adult supervision.

Battery Installation

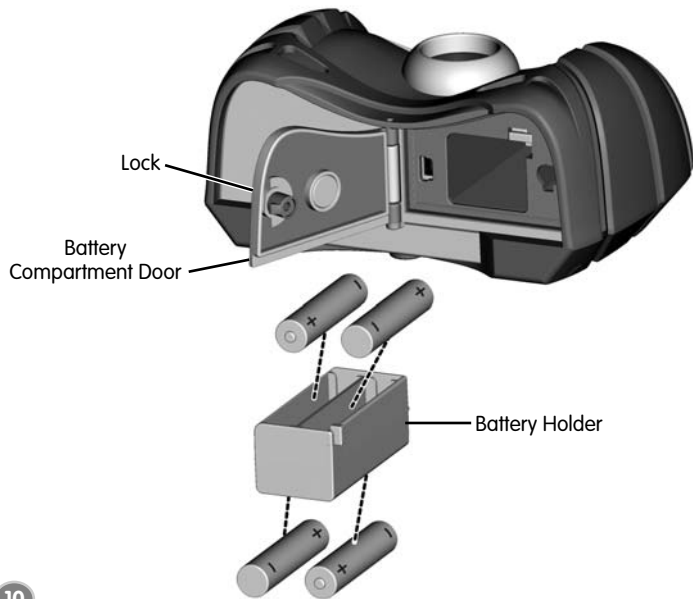

Battery Installation

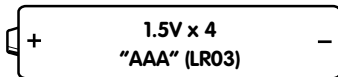

- Make sure camera power is off.
- Locate the battery compartment door on the bottom of the camera.
- Turn the lock on the battery compartment door a 1/4 turn. Open the battery compartment door.
- Remove the battery holder from the battery compartment.
- Insert four "AAA" (LR03) **alkaline** batteries into the battery holder.

Hint: We recommend using **alkaline** batteries for longer battery life. Do not use rechargeable batteries.

- Insert the battery holder into the battery compartment.
- Close the battery compartment door and turn the lock a 1/4 turn.
- When the low battery indicator appears on the LCD screen , it's time for an adult to change the batteries.



- Protect the environment by not disposing of this product with household waste (2002/96/EC). Check your local authority for recycling advice and facilities (Europe only).

Turning the Camera On and Off

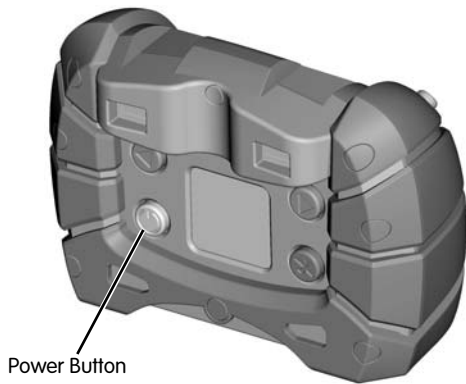

- Press the power button on the back of the camera to turn power on. You will hear a tone.
- To turn power off, press and hold the power button until you hear a tone.

Hint: If you have not used the camera for a while, it shuts off automatically. To turn it back on, simply press the power button.

Taking a Picture

- Have your child look through the viewfinder or look at the LCD screen to see the picture subject.
- While holding the camera steady, press the shutter button on the front of the camera. Listen for a “shutter sound” and look for the camera  icon on the LCD screen.
- The picture you just took will stay on the LCD screen for a few seconds so you can make sure you “got the shot.”

Hint: The number on the LCD screen indicates the number of pictures taken.

Shutter Button



Using the Flash

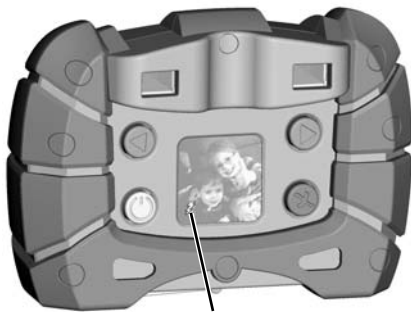

Flash Indicator

- If you are taking pictures in low light (dim light) and the flash is required, the flash will operate automatically. A lightning bolt ⚡ appears on the LCD screen and blinks until the flash is ready.
- While holding the camera steady, press the shutter button to take a picture.

Hint: The flash works best when your picture subject is about 4 ft. - 7.5 ft. (1.2 m - 2.2 m) from the camera.

- When the batteries are getting weak, the flash will not fully charge and the “no flash” lightning bolt ⚡ appears on the LCD screen. You can continue to take pictures without a flash but you will need to change batteries soon (see page 10).

Reviewing Pictures

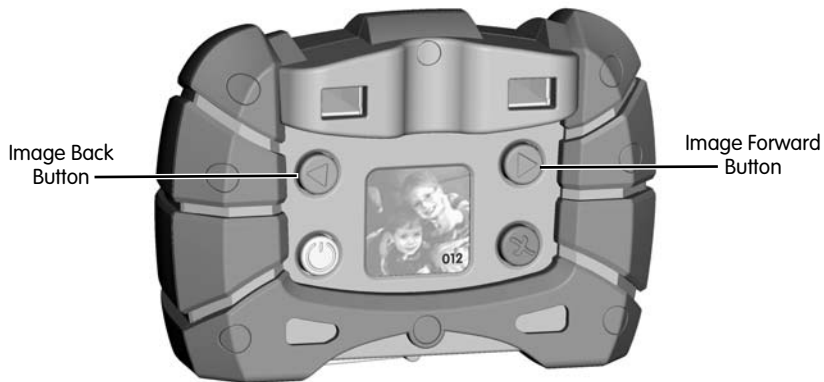

- Press the image forward or image back buttons to review the pictures you have taken.
- When you are finished reviewing, the camera switches back to normal picture taking mode in a few seconds.

Deleting Pictures

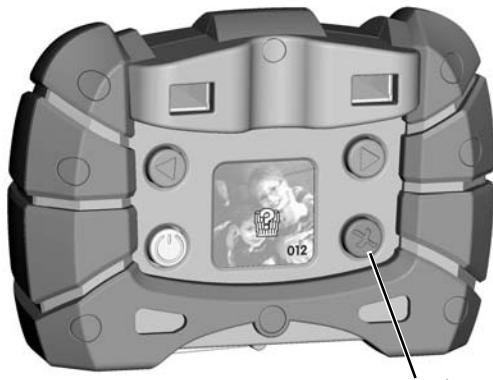





Image Delete Button

- If you decide you do not want a picture, first locate it by using the image forward or back buttons.
- Then press the image delete button . A trash can with a question mark  appears on the LCD screen.
- If you want to delete the picture, press the image delete button  again.
- If you decide you do not want to delete a picture, simply wait a few seconds and the trash can disappears.

Changing Picture Resolution

Your camera comes set up to take normal quality pictures (standard resolution). If you'd like to take higher quality pictures (high resolution), follow these steps.

- First press **both** the image back and image forward buttons **at the same time and hold ①**. Next, press the shutter button ②. You'll hear a tone.
- The high resolution icon appears on the LCD screen . You are ready to take pictures in high resolution.
- To change back to standard resolution, repeat this procedure.

Note: When you change batteries, the resolution resets to standard.

- When reviewing pictures on the camera, images taken in high resolution will have the high resolution icon  shown on the LCD (even though the image quality on the LCD is the same as standard resolution).
- Image quality can be noticed when viewed on your computer or when pictures are printed.
- High resolution pictures use up more internal memory than low resolution pictures.

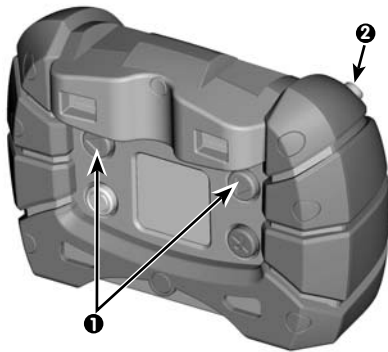

System Requirements



Operating System Compatible with Windows 2000 or higher and
Macintosh OS 10 or higher

Hardware Pentium Class 500 MHz processor or better

Input Port USB (version 1.1 or higher)

Note: Use any image editing software to manage or edit your photos.

Connecting Your Camera to Your Computer

- Open the battery compartment door and insert the USB cord (smaller end) into the USB port.
- Insert the larger end of the USB cord into a USB port on your computer, generally marked with this symbol .
- The camera turns on automatically and USB appears on the LCD screen .

Note: Do not disconnect the camera or computer while images are transferring to your computer.

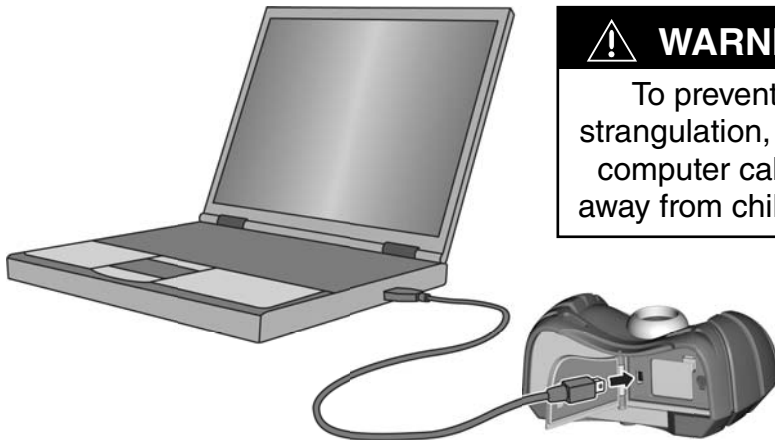

WARNING

To prevent strangulation, keep computer cables away from children.

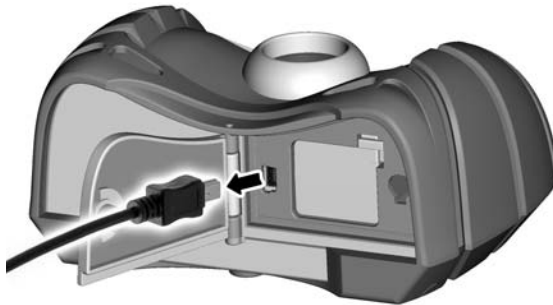

Disconnecting Your Camera

- To disconnect your camera, click “eject disk”  on your computer's task bar.
- Select the “USB Mass Storage Device” (your camera) and click “stop”.
- Click “OK” to confirm.
- A message will appear on your computer screen advising you to remove your device (camera).





- Unplug the USB cord from your computer, then your camera. The camera shuts off automatically.

Troubleshooting

Problem	Cause	Solution
Camera will not take pictures	Batteries are weak or exhausted 	Replace the batteries in the camera with four, new "AAA" (LR03) alkaline batteries.
	Camera is turned off	Press the power button on the back of the camera to turn it on.
	Camera memory is full of images ( appears on the LCD screen)	Download pictures to your computer or use the image delete button on the camera to remove some of them.
Photos too dark	Flash does not work because batteries are weak or exhausted	Replace the batteries in the camera with four, new "AAA" (LR03) alkaline batteries.
	You are out of the range of the flash	The range of the flash is about 4 ft. - 7.5 ft. (1.2 m - 2.2 m).
Photos too bright	You are too close to your subject	The range of the flash is about 4 ft. - 7.5 ft. (1.2 m - 2.2 m).
Flash takes too long to recharge	Batteries are weak or exhausted	Replace the batteries in the camera with four, new "AAA" (LR03) alkaline batteries.

Troubleshooting

Problem	Cause	Solution
Photos are blurry	Lens may be dirty or smudged	Clean the lens with a soft cloth.
	Camera moved when picture was taken	Try to keep the camera steady when you take pictures.
	Flash may not have been charged	Wait for flash to fully charge before you take a picture  .
	You are too close to your subject	The focus range is from about 4 ft. (1.2 m) - infinity
Cannot transfer pictures to the computer	USB cord may not be properly connected	Check cord connections on both your camera and your computer.
Product functions erratically or does not function at all	Static electricity may temporarily stop the electronic function of the camera and cause picture loss. For example, walking across the rug and touching the camera may create static electricity.	Reset the electronics by removing the batteries and putting them back in the battery compartment.
	Batteries are weak or exhausted 	Replace the worn batteries with four, new "AAA" (LR03) alkaline batteries.

FCC Statement (United States Only)

This equipment has been tested and found to comply with the limits for a Class B digital device, pursuant to Part 15 of the FCC Rules. These limits are designed to provide reasonable protection against harmful interference in a residential installation. This equipment generates, uses and can radiate radio frequency energy and, if not installed and used in accordance with the instructions, may cause harmful interference to radio communications. However, there is no guarantee that interference will not occur in a particular installation. If this equipment does cause harmful interference to radio or television reception, which can be determined by turning the equipment off and on, the user is encouraged to try to correct the interference by one or more of the following measures:

- Reorient or relocate the receiving antenna.
- Increase the separation between the equipment and receiver.
- Consult the dealer or an experienced radio/TV technician for help.

Note: Changes or modifications not expressly approved by the manufacturer responsible for compliance could void the user's authority to operate the equipment.

This device complies with Part 15 of the FCC Rules. Operation is subject to the following two conditions: (1) This device may not cause harmful interference and (2) this device must accept any interference received, including interference that may cause undesired operation.

Visit us on line at www.service.fisher-price.com

Call our Consumer Relations Department, toll-free at **1-888-892-6123**. Hearing-impaired consumers using TTY/TDD equipment, please call 1-800-382-7470. Write to us at: Fisher-Price® Consumer Relations, 636 Girard Avenue, East Aurora, New York 14052.

For countries outside the United States:

CANADA: Questions? **1-888-892-6123**. Mattel Canada Inc., 6155 Freemont Blvd., Mississauga, Ontario L5R 3W2; www.service.mattel.com.

GREAT BRITAIN: Mattel UK Ltd, Vanwall Business Park, Maidenhead SL6 4UB.
Helpline: 01628 500303. www.service.mattel.com/uk

AUSTRALIA: Mattel Australia Pty. Ltd., 658 Church Street, Locked Bag #870, Richmond, Victoria 3121 Australia. Consumer Advisory Service 1300 135 312.

NEW ZEALAND: 16-18 William Pickering Drive, Albany 1331, Auckland.

ASIA: Mattel East Asia Ltd, Room 1106, South Tower, World Finance Centre, Harbour City, Tsimshatsui, HK, China.



N102 / Z83

Windows is a registered trademark of Microsoft Corporation.

Fisher-Price, Inc., a subsidiary of Mattel, Inc., East Aurora, NY 14052 U.S.A.

©2009 Mattel, Inc. All Rights Reserved. ® and ™ designate U.S. trademarks of Mattel, Inc., unless otherwise indicated.

PRINTED IN CHINA

R7315a-0920