



TUB RAGERS™

INSTRUCTIONS

CONTENTS

4+

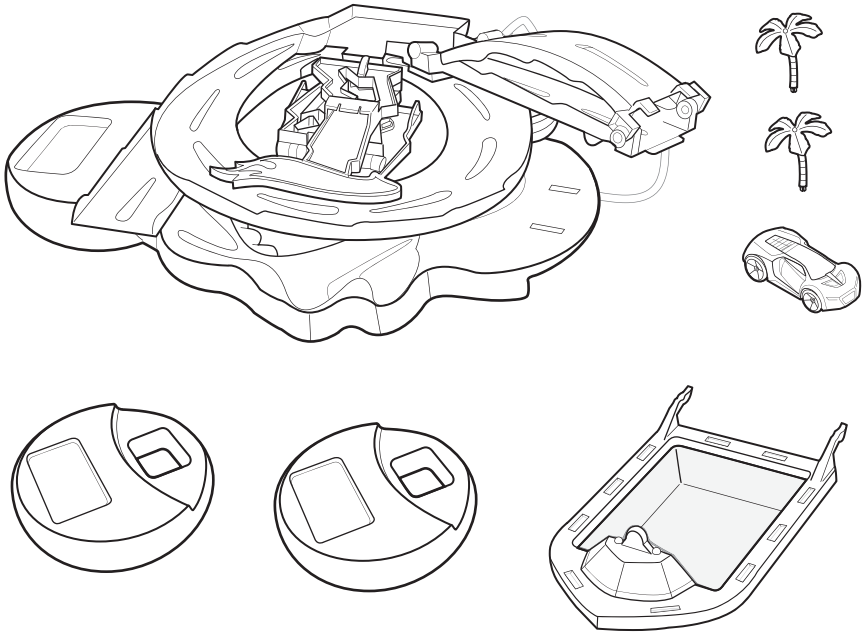

© 2009 Mattel, Inc. All Rights Reserved. Consumer Relations – Mattel, Inc., 636 Girard Avenue, East Aurora, NY 14052 U.S.A. – 1-800-524-8697. service.mattel.com. • Mattel Canada Inc., Mississauga, Ontario L5R 3W2. You may call us free at 1-800-524-8697. • Mattel U.K. Ltd., Vanwall Business Park, Maidenhead SL6 4UB, Helpline 01628500303 • Mattel Australia Pty., Ltd., Richmond, Victoria, 3121. Consumer Advisory Service - 1300 135 312. • Mattel East Asia Ltd., Room 1106, South Tower, World Finance Centre, Harbour City, Tsimshatsui, HK, China. • Diimport & Diedarkan Oleh: Mattel SEA Ptd Ltd.(993532-P) Lot 13.5, 13th Floor, Menara Lien Hoe, Persiaran Tropicana Golf Country Resort, 47410 PJ. Tel:03-78803817, Fax:03-78803867.

ASSEMBLY

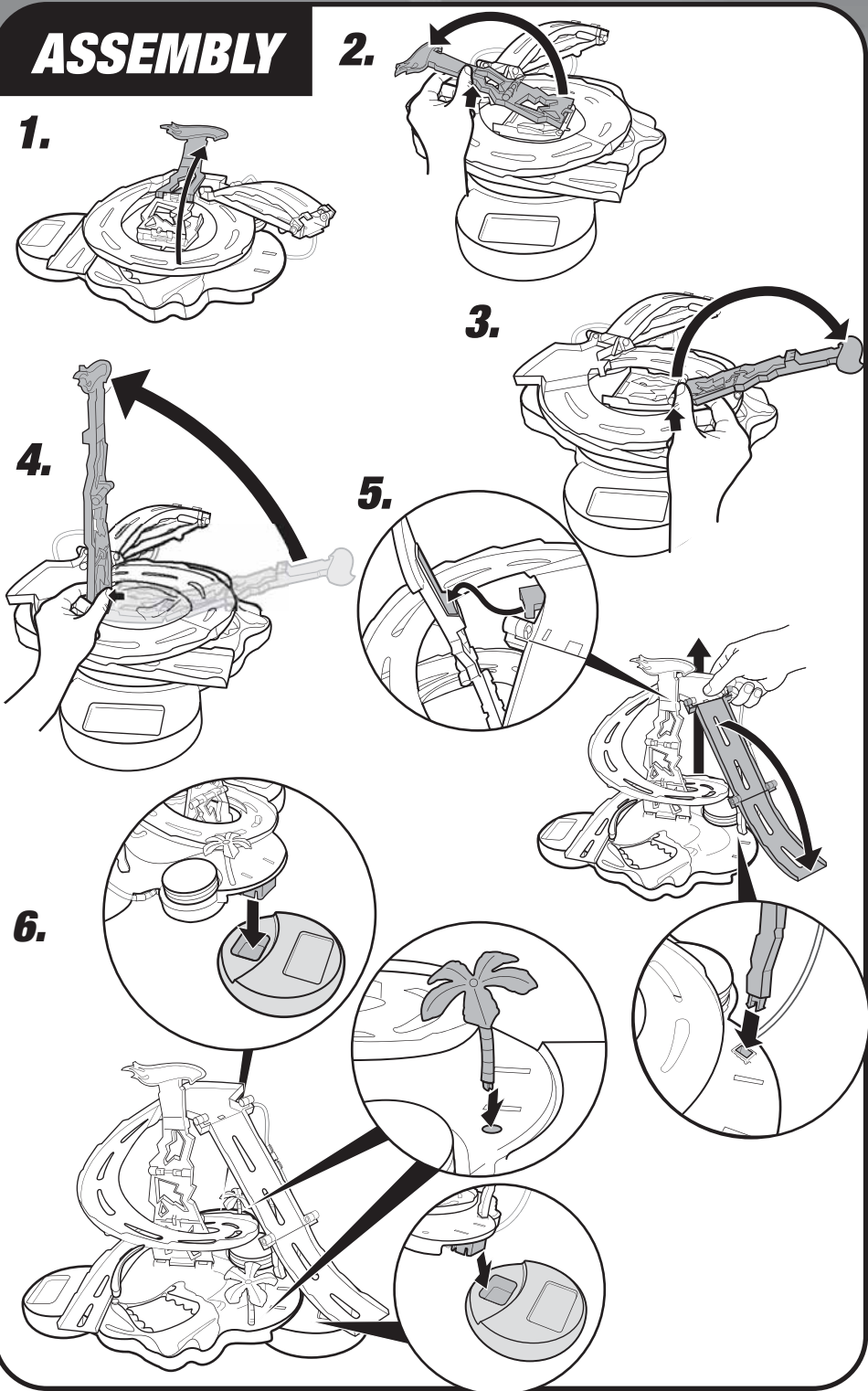

INSTRUCTION SHEET SPECIFICATIONS

Toy No.: R8164
Part No.: 0920
Trim Size: 11" x 8.5"
Folded Size: 5.5" W x 8.5" H
Type of Fold: accordion
colors: 1C + 1C
Colors: Black
Paper Stock: White Offset
Paper Weight: 80 lb.
EDM No.:

TO PLAY

Option 1

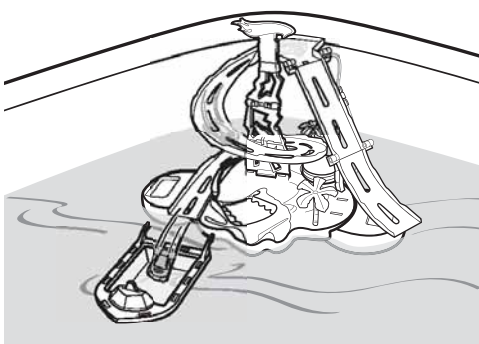

Option 2

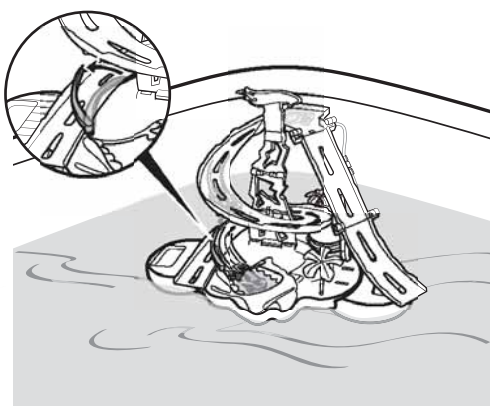

Option 3

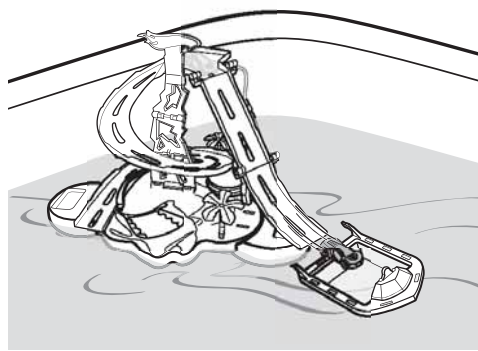

Option 4

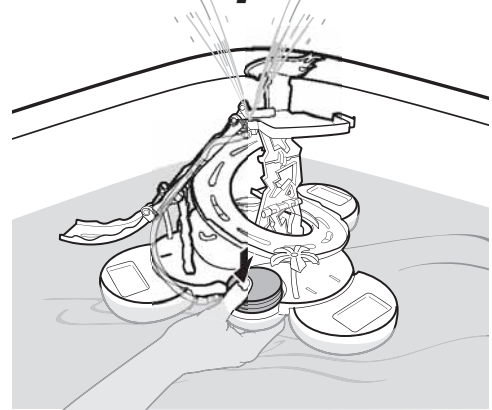

Option 5

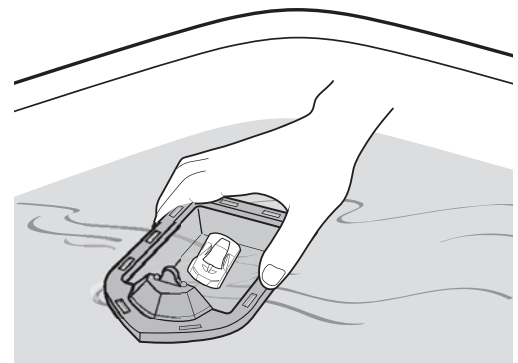

STORE

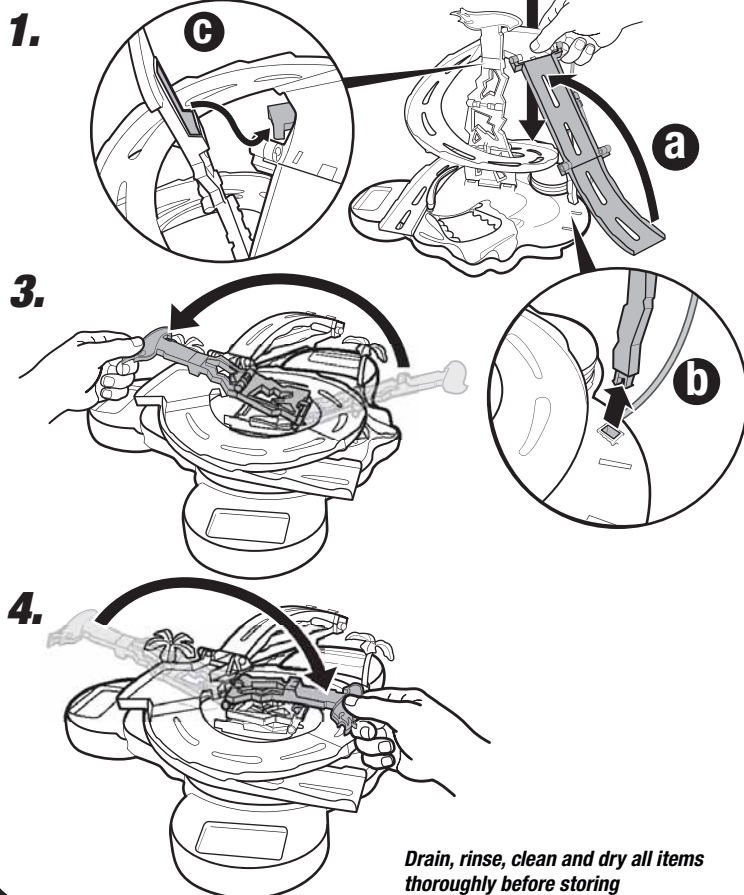

Drain, rinse, clean and dry all items thoroughly before storing

RE-INSTALL THE HOSE ADULT SUPERVISION REQUIRED.

