

Fisher-Price®

# Kid-Tough™

Video Camera



[www.fisher-price.com](http://www.fisher-price.com)

# Quick Start

## A Real Video Camera for Preschoolers!

- 1** Press and hold the power button  to turn your video camera ON.
- 2** Press the record button  to stop the video demo.
- 3** Aim the camera at your video subject and press the record button .
- 4** Hold the camera steady and slowly move it to capture the action! Press the record button  again when you are finished recording.
- 5** Press the video play/pause button  to review your video instantly on your video camera.
- 6** Your video isn't quite perfect yet? Press the delete button  and try again!



# Consumer Information

- Please keep this instruction booklet for future reference, as it contains important information.
- Requires four “AA” (LR6) **alkaline** batteries (included) for operation.
- This product requires the installation and use of content management software to transfer and view video on your personal computer (PC). Simply download this software by going to: [www.fisher-price.com/kidtough](http://www.fisher-price.com/kidtough). Mac users do not need additional software to transfer and view video.
- Adult assembly is required for battery replacement or SD card installation. Tool required: Phillips or slotted screwdriver (not included).
- This product includes an internal memory of 256 MB or about 15 minutes of video. For extra recording time, use an Secure Digital (SD) card (not included) in this product.
- **IMPORTANT!** Use only a new or clean SD card in the video camera. Once inserted (if not using a new or clean SD card), **files (e.g. photos or pictures) on the SD card will be erased.** This is intentional, to protect the video camera from a virus or malware, and to protect your PC.
- Keep the video camera away from direct sunlight and excessive heat.
- Wipe the video camera only with a soft, clean cloth. Do not immerse this product.
- This video camera has no consumer serviceable parts. Please do not take this toy apart.
- Product features may be different than images included in these instructions.
- Type - Equivalent to IEC Standard publication 529 IPX7.
- The toy is not to be connected to more than the recommended number of power supplies.

## Computer System Requirements

Operating System.....Microsoft Windows XP, Windows Vista™ or Windows 7

Hard Drive .....20 MB available

USB Port.....1.1

**Internet connection required** (to download PC software).

# Features

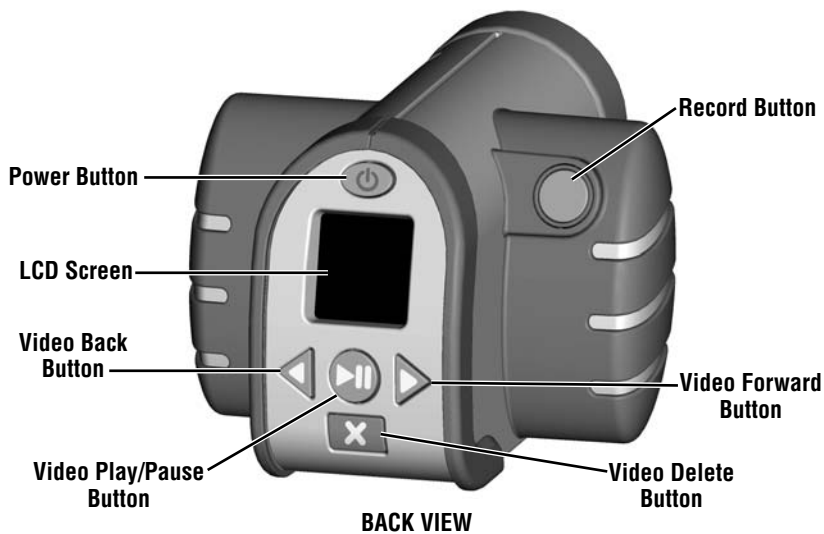
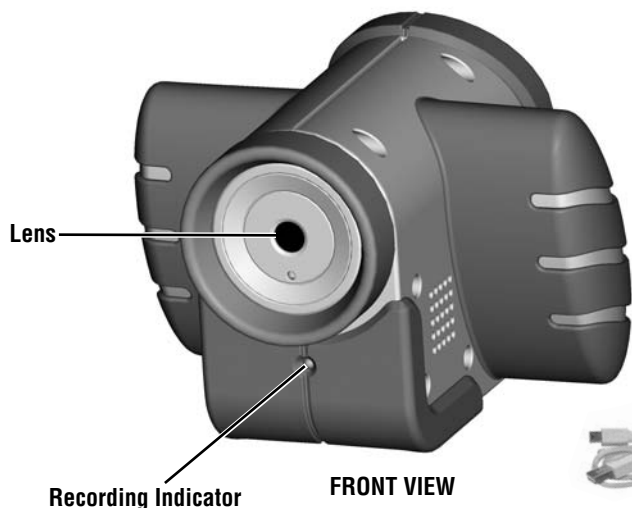

# Features

**Lens** - Aim at your subject when recording videos.

**Recording Indicator** - Indicator light flashes when video is recording.

**Power Button** - Press and hold to turn power ON. Press again to turn power OFF.

**LCD Screen** - Allows you to easily record and review your videos.

**Video Play/Pause Button** - Press to play your videos. Press again to pause.

**Video Forward and Back Buttons** - Press to scroll through more videos.

**Video Delete Button** - Press to delete a video. Press again to confirm deletion.

**SD Card Slot** - Open the battery compartment to insert a new or clean SD card for more memory! SD card not included.

**USB Port** - Insert the USB cable to watch videos on your computer.

**AV Output Jack** - Insert an AV cable (not included) to watch videos on your TV.

**USB Cable** - Use to connect the video camera to your computer.

## Video Camera Specifications

Video Resolution ..... 320 x 240 QVGA (without SD card) 640 x 480 VGA  
(with SD card - not included and sold separately)

Internal Memory ..... 256 MB (approximately 15 minutes of video)

LCD Screen ..... 1,4" color TFT LCD preview.

Connectivity ..... USB port (version 1.1 or higher)  
AV output jack (AV cable not included).

Batteries ..... 4 "AA" (LR6) **alkaline** batteries (included).

# Battery Replacement

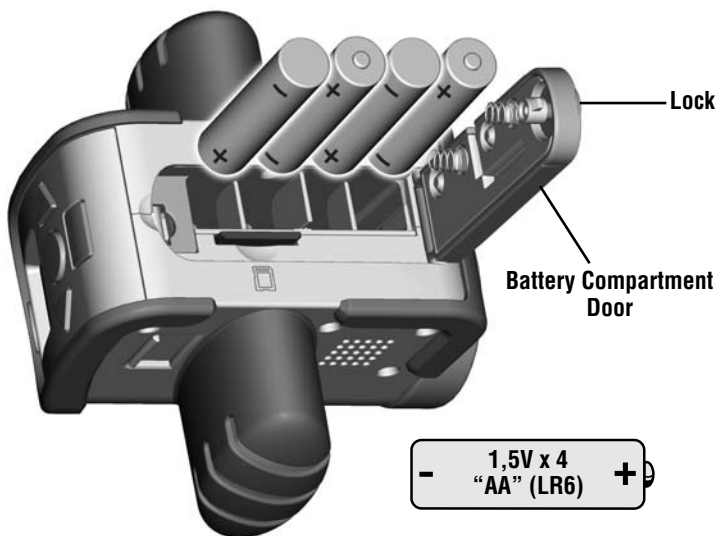

**For best performance, we recommend replacing the batteries that came with this toy with four, new “AA” (LR6) alkaline batteries.**

- Make sure video camera power is off.
- Locate the battery compartment door on the bottom of the video camera.
- Turn the lock on the battery compartment door a ¼ turn with a slotted or Phillips screwdriver. Open the battery compartment door. Remove the batteries and dispose of them properly.
- Insert four, new “AA” (LR6) **alkaline** batteries into the battery compartment.

**Hint:** We recommend using **alkaline** batteries for longer battery life. Do not use rechargeable batteries.

- Close the battery compartment door and turn the lock a ¼ turn with a slotted or Phillips screwdriver.
- When the low battery indicator appears on the LCD screen , it's time for an adult to change the batteries.



- Protect the environment by not disposing of this product with household waste (2002/96/EC). Check your local authority for recycling advice and facilities (Europe only).

# Battery Safety Information

In exceptional circumstances, batteries may leak fluids that can cause a chemical burn injury or ruin your toy. To avoid battery leakage:

- Do not mix old and new batteries or batteries of different types: alkaline, standard (carbon-zinc) or rechargeable (nickel-cadmium).
- Insert batteries as indicated inside the battery compartment.
- Remove batteries during long periods of non-use. Always remove exhausted batteries from the toy. Dispose of batteries safely. Do not dispose of the product in a fire. The batteries inside may explode or leak.
- Never short-circuit the battery terminals.
- Use only batteries of the same or equivalent type, as recommended.
- Do not charge non-rechargeable batteries.
- Remove rechargeable batteries from the toy before charging.
- If removable, rechargeable batteries are used, they are only to be charged under adult supervision.



# Recording Video

- Press and hold the power button  on the back of the video camera to turn power ON. You will hear a tone.

- To turn power OFF, press the power button. You will hear a tone.

**Hint:** *If you have not used the video camera for a while, it shuts off automatically. To turn it back on, simply press the power button.*

- Look at the LCD screen to see the video subject.

- Press the record button . Listen for the “recording sound”, look at the flashing recording  icon on the LCD screen. The recording indicator on the front of the camera will also flash during recording.

- When ready, press the record button  again to stop the video. The file saving icon  will appear on the LCD screen.





# LCD Screen Icon Glossary



Flashes in the upper left corner of the screen when a video is recording.



Appears on screen while video is saving on the video camera.



Appears on screen when a video is ready to play. Press the video play/pause button to play the video.



Appears on screen when a video is paused. Press the video play/pause button to continue playing the video.



Appears when there are no videos saved on the video camera.



Appears on screen when you press the delete button. Press the delete button again to confirm you want to delete the video.



This orange icon appears when your video camera memory is almost full. Insert a new or clean SD card (not included) or delete some videos from the video camera.



This red icon appears when your video camera memory is full and cannot save any more video. Insert a new or clean SD card (not included) or delete some videos from the video camera.



Appears on screen when power is turned on and an SD card (not included) is inserted in the video camera.



Indicates the SD card (not included) is locked. Remove the SD card from the SD card slot and slide the switch on the card to unlock it.



Flashes on screen and then remains in the upper right corner of the screen when there is less than 10% battery power left.



Flashes on screen and then remains in the upper right corner of the screen when there is less than 5% battery power left. Replace the batteries in the video camera with four “AA” **alkaline** batteries.

# Reviewing Videos

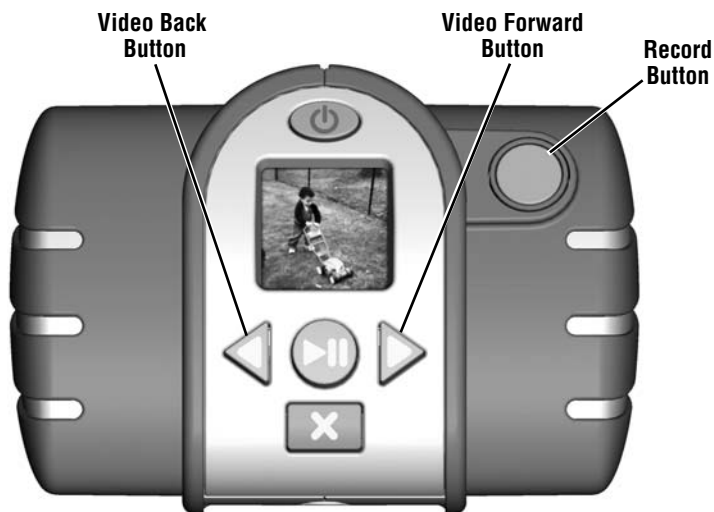



- Press the video forward or video back buttons ◀▶ to scroll through recorded video.
- Press the play/pause button ▶|| to watch a video.
- When you are finished reviewing, press the record button to return to the live screen and record more videos.

**Hint:** If you have installed an SD card (sold separately), you will only view video on the SD card (and not on the video camera's internal memory). To view video on the video camera, simply remove the SD card.

# Deleting Videos







**Video Delete  
Button**

- First locate the video you'd like to delete by using the video forward or back buttons ◀▶.
- Then press the video delete button . A trash can with a question mark  appears on the LCD screen.
- If you still would like to delete the picture, press the video delete button  again.
- If you decide you do not want to delete a video, simply wait a few seconds and the trash can with question mark disappears on the LCD screen. Or, press the either the video forward or back button ◀▶.
- To delete all video all at once, use the content management software (go to [www.fisher-price.com/kidtough](http://www.fisher-price.com/kidtough) to download this software). Once installed on your PC, go to Parental Controls. In the “Erase videos on camera after import” section, click on the trash can icon.

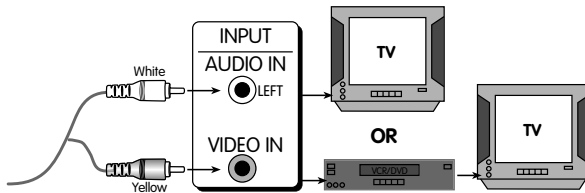
# Share the Fun on Your TV

**Note:** You will need an AV cable (not included) with a 3,5 mm pin to view video on your TV.



- Slide the AV and USB door on the side of the video camera open..
- Insert the AV cable pin into the AV output jack on the video camera.
- Plug the audio-video pins into the matching colored input jacks on your TV or DVD player/VCR (Yellow for Video In and White for Left Audio In).
- Press the power button  on your video camera to turn the power ON.
- Turn on your TV or DVD player/VCR. To find the picture on your TV screen, you may need to set your TV's or DVD player/VCR's mode selector to INPUT or VIDEO IN.
- Press the play/pause button  on the video camera to watch your videos.
- Press the video forward or back buttons   to scroll through and watch more videos.

# SD Card Installation

**IMPORTANT!** Use only a new or clean SD card in the video camera. Once inserted (if not using a new or clean SD card), **files (e.g. photos or pictures) on the SD card will be erased.** This is intentional, to protect the video camera from a virus or malware, and to protect your PC.

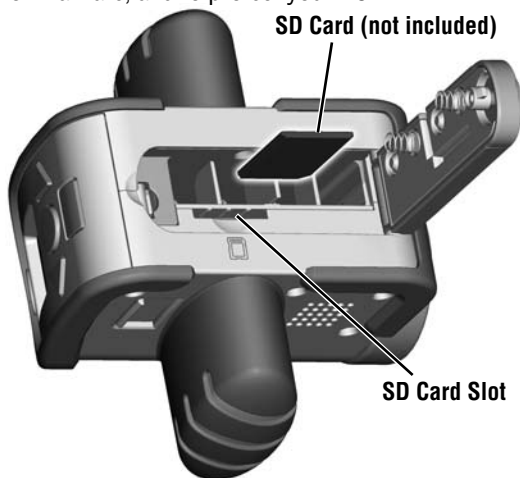

- Your video camera comes set up to take 320 x 240 QVGA quality videos, and can store approximately 15 minutes of video. If you'd like to take higher quality videos you can insert a new or clean SD card (not included) and take 640 x 480 VGA quality videos.

**Note:** A 1 GB SD card can store approximately 30 minutes of the higher quality video.

- Turn the battery compartment lock a  $\frac{1}{4}$  turn with a slotted or Phillips screwdriver. Open the battery compartment door.
- Locate the SD card slot below the battery compartment.
- Insert a new or clean SD card into the slot.

**Hint:** Once you have used an SD card in the video camera, and put that same SD card back into the device at a later time, you will not lose what was recorded previously from our video camera. To avoid mix-ups and disappointments, it's best to reserve a particular SD card for use only in the video camera.

- Close the battery compartment door and turn the lock  $\frac{1}{4}$  turn with a slotted or Phillips screwdriver.

# Content Management Software

- If using a PC to transfer, organize and view video, download content management software (PC compatible only). Go to [www.fisher-price.com/kidtough](http://www.fisher-price.com/kidtough) and follow the instructions to download the software.
- The content management software is PC compatible only. To view videos on a Mac, connect the video camera to your computer (see next section). The Kid Tough™ Video Camera will appear as a removable storage device on your desktop.



Your videos will be located at:

- NO NAME
  - DCIM
  - 100DSCIM
- If you are using an SD Card (see page 13) your videos will be located at:
    - Untitled
    - DCIM
    - 100DSCIM

**Hint:** *If you have renamed your SD Card it will appear on the desktop as named.*

- To save videos onto your Mac computer, drag and drop the files to the desired location.

# Content Management Software

- Slide open the AV and USB door and insert the USB cord (smaller end) into the USB port on your video camera.
- Insert the larger end of the USB cord into a USB port on your computer, generally marked with this symbol .
- The video camera turns on automatically and  will appear on the LCD screen. The content management software will automatically open when you connect your video camera to the computer.

**Note:** Do not disconnect the video camera or computer while videos are transferring to your computer.

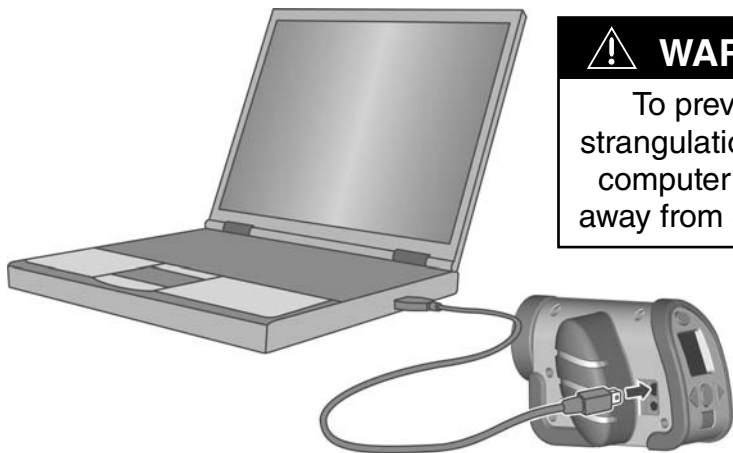



## WARNING

To prevent strangulation, keep computer cables away from children.

# Content Management Software



## Getting Started

- The content management software automatically opens when you connect your video camera to the computer. You can also double-click on the  to open the computer software program.
  - Click on the  to change the background color of the computer software.
- Note:** This option is only available if the Force Screen Resolution setting is turned OFF. See **Parental Controls**.
- Click on the **x** to exit the computer software.



# Content Management Software



Parental Controls

## Parental Controls

- Click on the  to adjust your preferences.
- **Set Password** - Protect access to your desktop and hard drive by setting a password. Type your password in the Set Password and Confirm Password fields.

**Note:** If you set a password, you cannot enter Parental Controls or exit the software without entering the password.

**Automatic Updates** - Click to turn automatic updates ON or OFF. To receive updated software, we recommend selecting ON.

- **Force Screen Resolution** - Click to turn ON or OFF.
- **Erase videos on camera after import** - Click to turn this feature ON or OFF.

 - Click to import videos that are saved on your computer into the computer software program.

- Click on the  to save your changes and exit parental controls.

# Content Management Software



- The import screen will open when the computer software launches.
- Click the  to import your new videos onto your computer. Click the **x** to close the import window without importing videos.

**Hint:** If you have installed an SD card (sold separately), you will only import video on the SD card (and not on the video camera's internal memory). To import video on the video camera, simply remove the SD card.







- Click on a video in the video gallery and click the  to watch it.



**Hint:** You can also double-click on a video to watch it.

# Content Management Software





- Click on the  to pause your video. Click on the  to start it again.
- Click on the  or  to adjust the size of your video in the viewing window.
- Click on the  to return to the video gallery.





- Click on the  to add a video to your favorites.
- Click on the  again to remove it from your favorites.

# Content Management Software



- Click on the  to show only your favorite videos in the video gallery.
- Click on the  to show all your videos in the video gallery.



- To delete a video from the video gallery, click on the video. Then, click on the  to delete the video from your computer.
- Click on the  to confirm you want to delete it.
- If you decide you do not want to delete the video, click on the .



# Content Management Software

- To disconnect your video camera, click “Safely Remove Hardware”  on your computer’s task bar.
- Select the “Safely Remove USB Mass Storage Device” (your video camera).
- A message will appear on your computer screen advising you to remove your device (video camera).



- Unplug the USB cord from your computer, then your video camera.

# Troubleshooting

Problem	Cause	Solution
Video camera will not record videos	Batteries are weak or exhausted 	Replace the batteries with four, new "AA" (LR6) <b>alkaline</b> batteries.
	Video camera is turned off	Press the power button on the back of the camera to turn it on.
	Video camera memory is full of videos (  appears on the LCD screen)	Download videos to your computer or use the video delete button on the camera to remove some of them.
Cannot transfer videos to the computer	USB cord may not be properly connected	Check cord connections on both your camera and your computer.
Product functions erratically or does not function at all	Static electricity may temporarily stop the electronic function of the camera and cause picture loss. For example, walking across the rug and touching the camera may create static electricity.	Reset the electronics by removing the batteries and replacing them in the battery compartment.
	Batteries are weak or exhausted 	Replace the batteries with four, new "AA" (LR6) <b>alkaline</b> batteries.
	Camera is too cold (left out or used in freezing temperatures)	Normal function will return once camera warms up.

# Consumer Information

## **FCC Statement (United States Only)**

This equipment has been tested and found to comply with the limits for a Class B digital device, pursuant to Part 15 of the FCC Rules. These limits are designed to provide reasonable protection against harmful interference in a residential installation. This equipment generates, uses and can radiate radio frequency energy and, if not installed and used in accordance with the instructions, may cause harmful interference to radio communications. However, there is no guarantee that interference will not occur in a particular installation. If this equipment does cause harmful interference to radio or television reception, which can be determined by turning the equipment off and on, the user is encouraged to try to correct the interference by one or more of the following measures:

- Reorient or relocate the receiving antenna.
- Increase the separation between the equipment and receiver.
- Consult the dealer or an experienced radio/TV technician for help.

Note: Changes or modifications not expressly approved by the manufacturer responsible for compliance could void the user's authority to operate the equipment.

This device complies with Part 15 of the FCC Rules. Operation is subject to the following two conditions: (1) this device may not cause harmful interference and (2) this device must accept any interference received, including interference that may cause undesired operation.

## **ICES-003**

- This Class B digital apparatus complies with Canadian ICES-003.
- Operation is subject to the following two conditions: (1) this device may not cause harmful interference and (2) this device must accept any interference received, including interference that may cause undesired operation.

## **NMB-003**

- Cet appareil numérique de la classe B est conforme à la norme NMB-003 du Canada.
- L'utilisation de ce dispositif est autorisée seulement aux conditions suivantes : (1) il ne doit pas produire de brouillage et (2) l'utilisateur du dispositif doit être prêt à accepter tout brouillage radioélectrique reçu, même si ce brouillage est susceptible de compromettre le fonctionnement du dispositif.



## CONSUMER ASSISTANCE

1-888-892-6123 (US & Canada)

1300 135 312 (Australia)



[service.fisher-price.com](http://service.fisher-price.com)

**Fisher-Price, Inc., 636 Girard Avenue, East Aurora, NY 14052.**

**Hearing-impaired consumers: 1-800-382-7470.**

---

Outside the United States:

Canada: Mattel Canada Inc., 6155 Freemont Blvd.,  
Mississauga, Ontario L5R 3W2; [www.service.mattel.com](http://www.service.mattel.com).

Great Britain: Mattel UK Ltd, Vanwall Business Park,  
Maidenhead SL6 4UB. Helpline: 01628 500303.  
[www.service.mattel.com/uk](http://www.service.mattel.com/uk)

Mattel Europa, B.V., Gondel 1, 1186 MJ Amstelveen, Nederland.

Australia: Mattel Australia Pty. Ltd., 658 Church Street,  
Locked Bag #870, Richmond, Victoria 3121 Australia.

New Zealand: 16-18 William Pickering Drive,  
Albany 1331, Auckland.

Windows is a registered trademark of Microsoft Corporation in the United States and other countries. Windows Vista is either a registered trademark or trademark of Microsoft Corporation in the United States and other countries.

Mac, Mac OS and iTunes are trademarks of Apple Inc., registered in the U.S. and other countries.

Fisher Price, Inc., a subsidiary of Mattel, Inc., East Aurora, NY 14052 U.S.A.

©2011 Mattel, Inc. All Rights Reserved. © and ™ designate U.S. trademarks of Mattel, Inc., unless otherwise indicated.