

# HOT WHEELS™

Fisher-Price®

# TRIO™

WITH BRICKS, STICKS & PANELS



[www.triobuilding.com](http://www.triobuilding.com)

# Parts Piezas Pièces Peças

## V9539

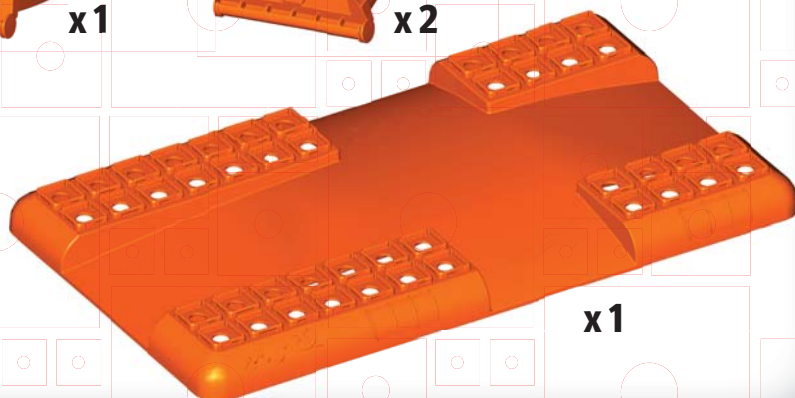
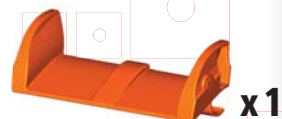
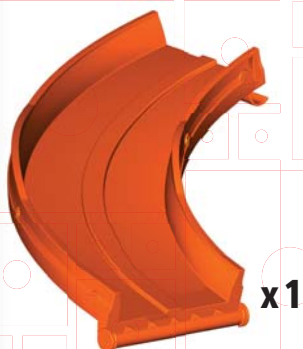
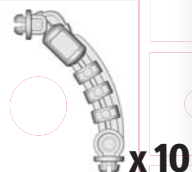
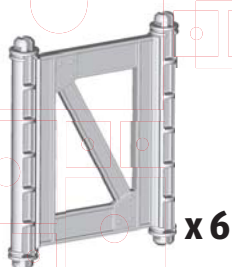
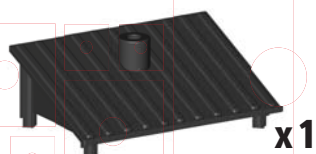
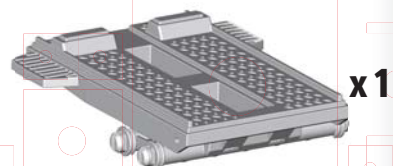
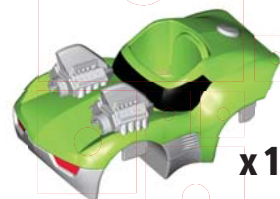

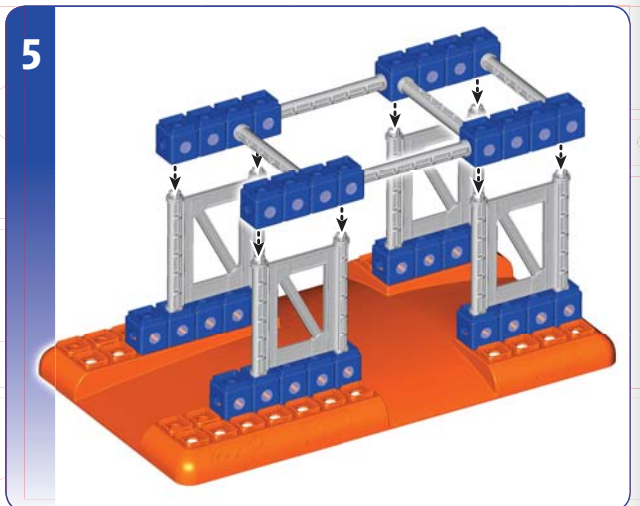
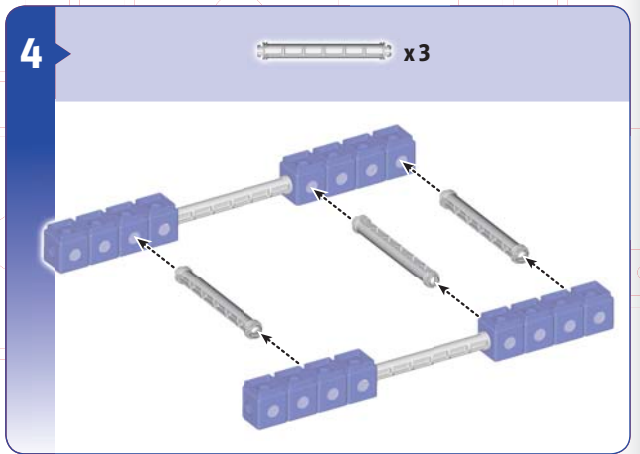
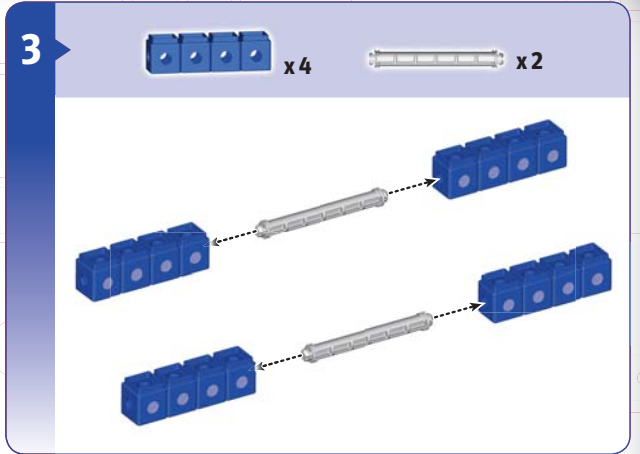
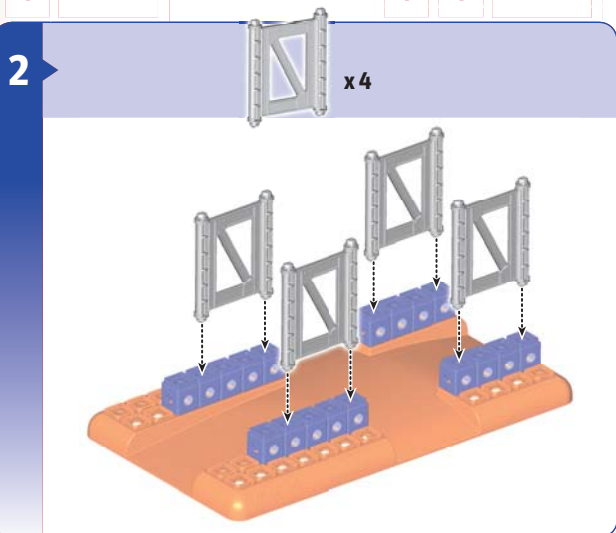
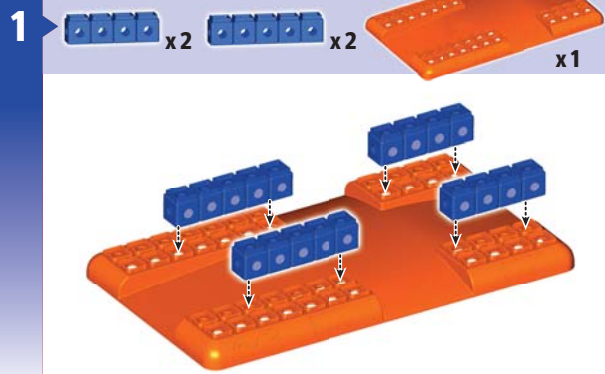

6

 x3     x1

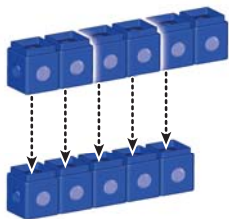

10

 x3     x1



7

 x1

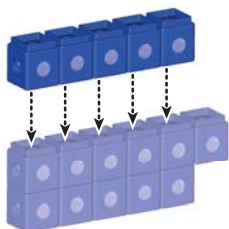

11

 x1

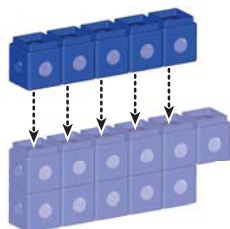

8

 x1

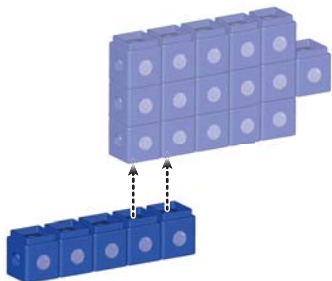

12

 x1

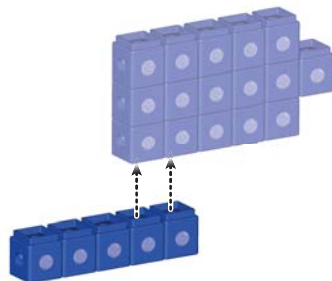

9

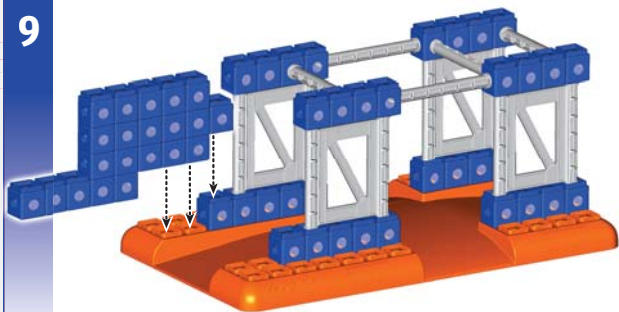

13

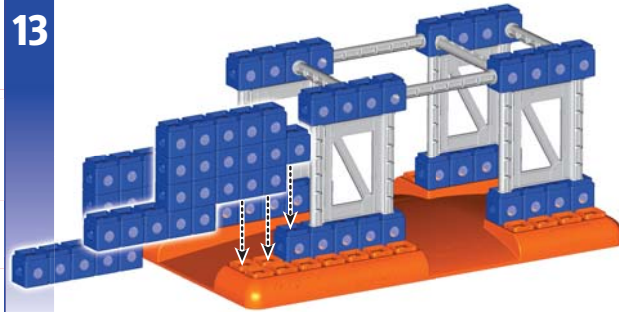

14

Blue square hole brick x2    Grey axle x1



17

Blue 1x4 Technic brick with holes x1    Grey axle x1    Grey Technic plate with holes x1

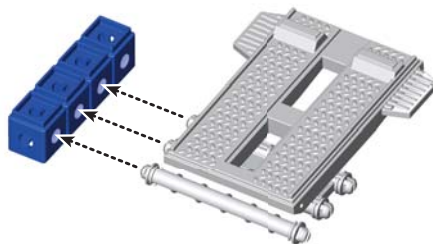

15

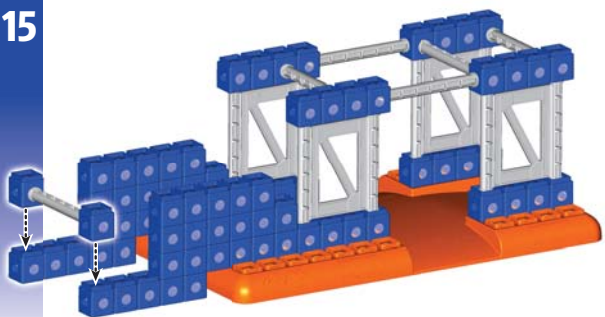

18

Blue 1x4 Technic brick with holes x1

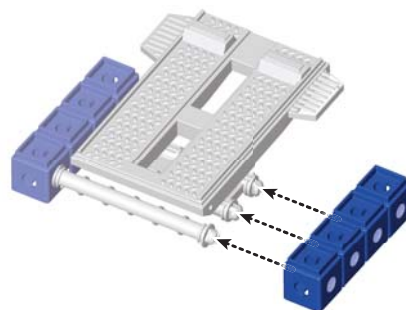

16

Green Technic panel with cartoon image x2

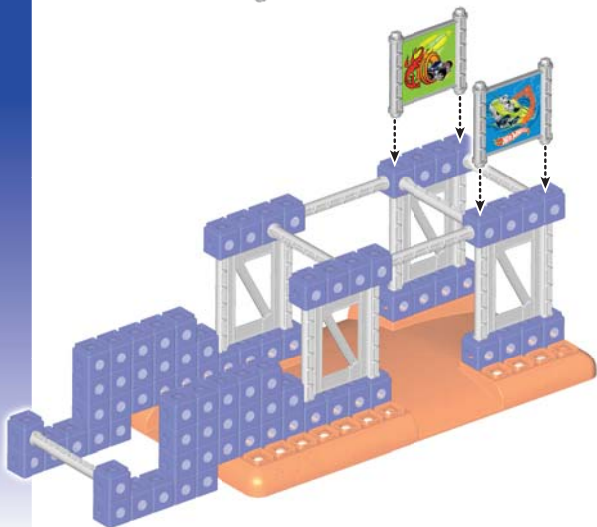

19

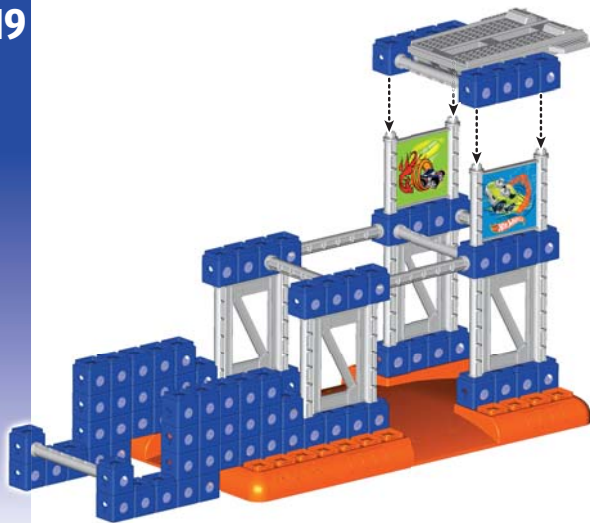

20

 x4

 x2

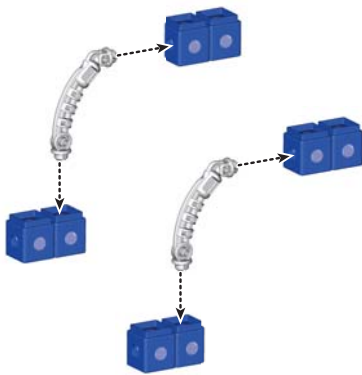

23

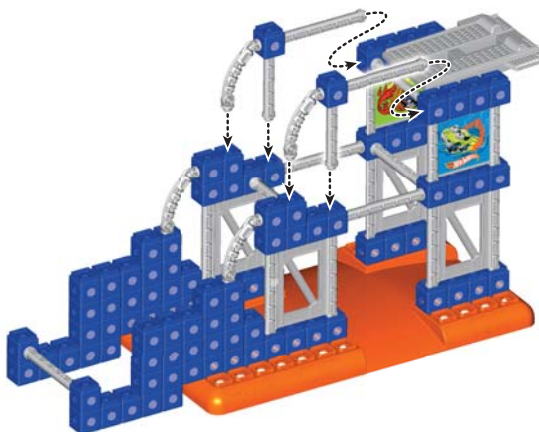

21

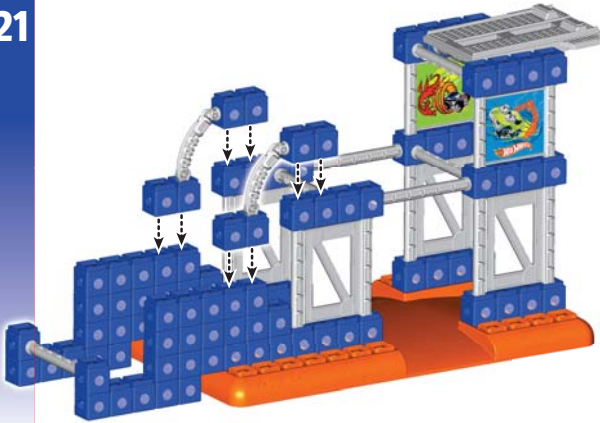

24

 x1

 x1

 x2

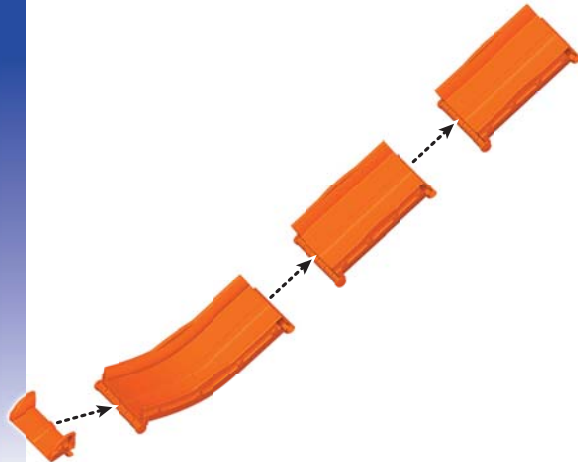

22

 x2

 x2

 x2

 x2

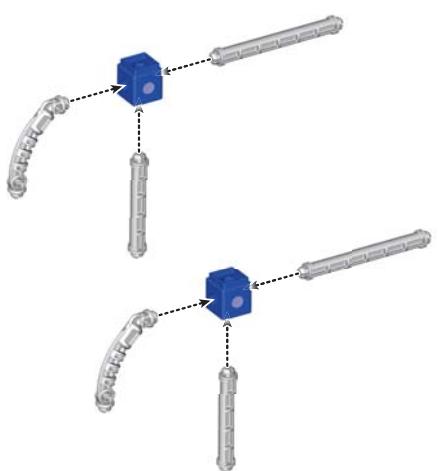

25

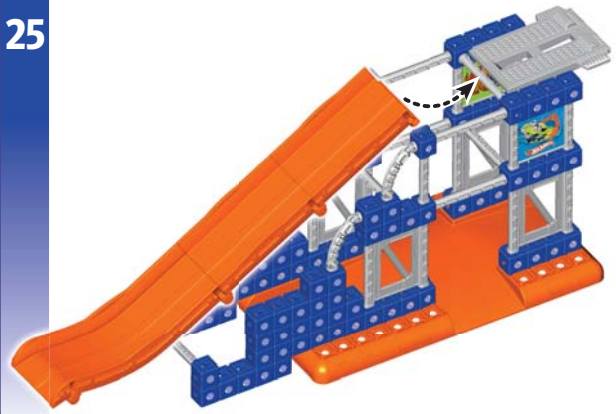

26

 x2

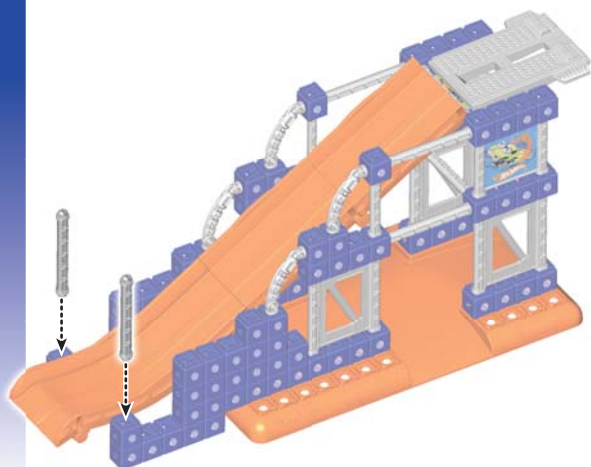

29

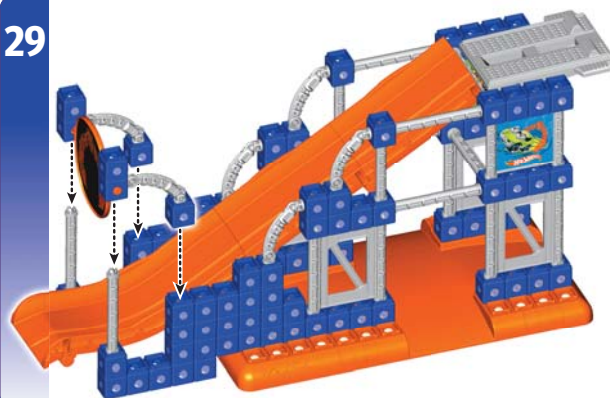

27

 x6

 x2

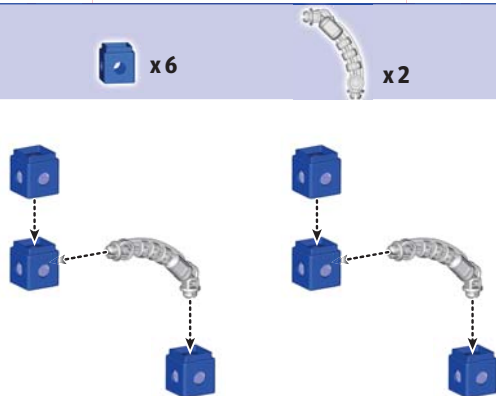

30

 x2

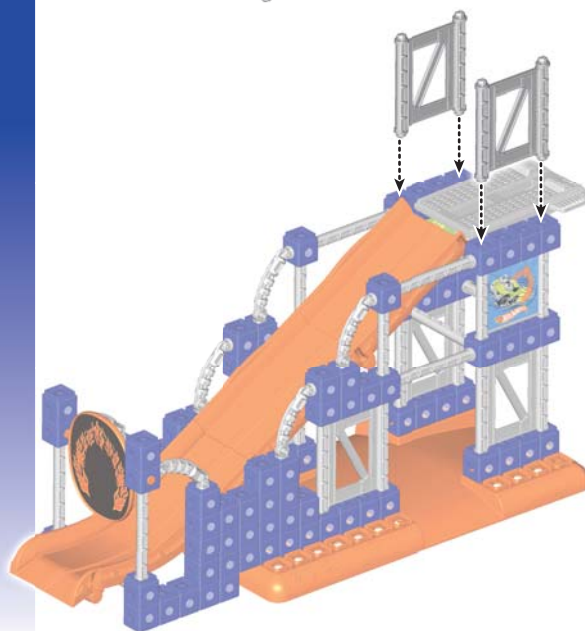

28

 x1

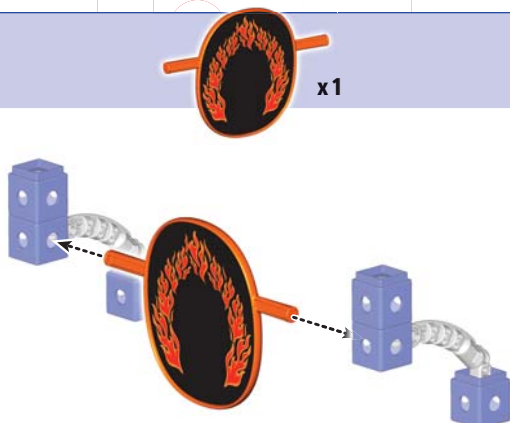

31

 x2

 x2

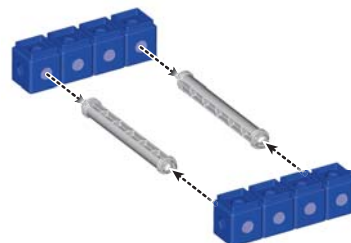

32



34

 x2  
  x2  
  x4

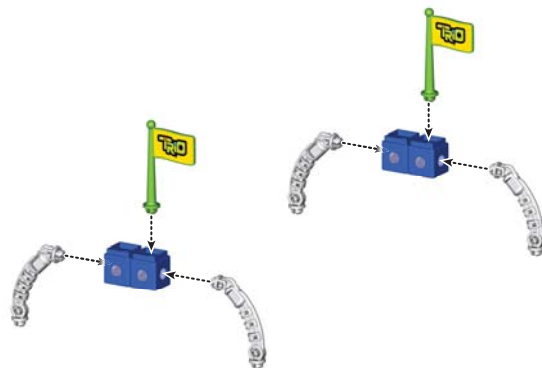

33

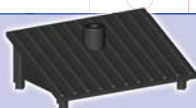
 x1

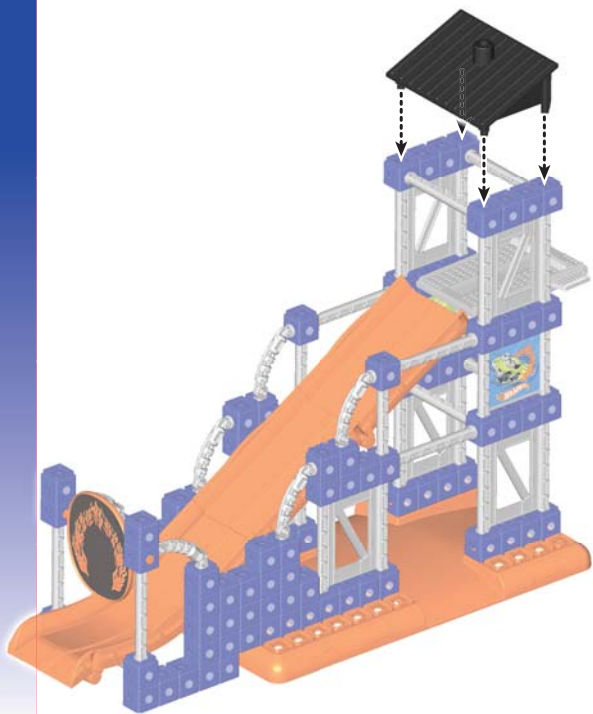

35



36

 x1





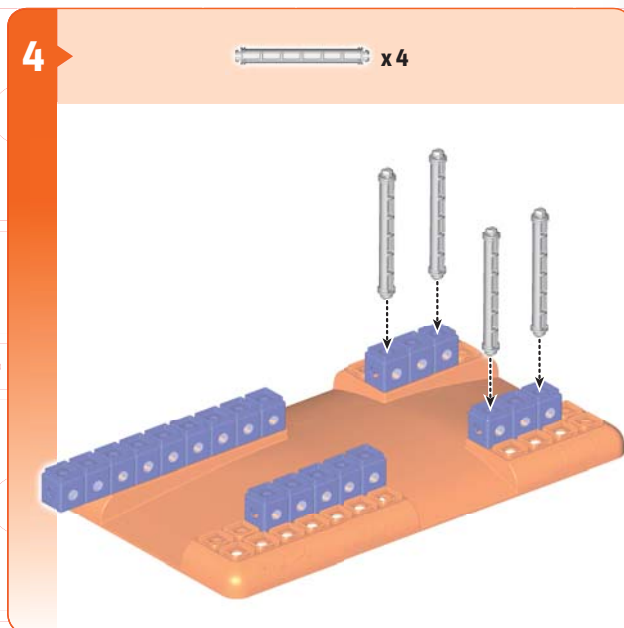
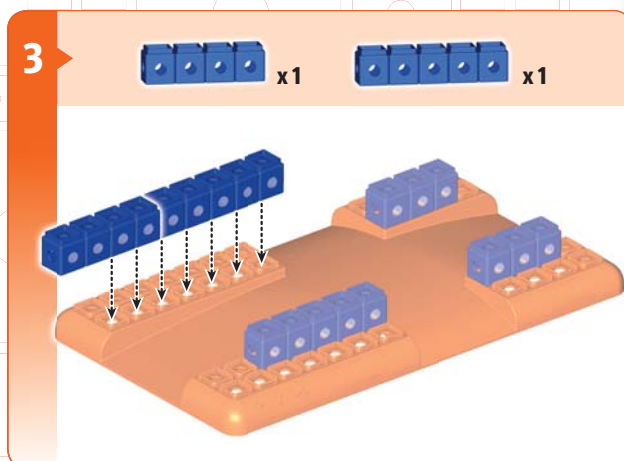
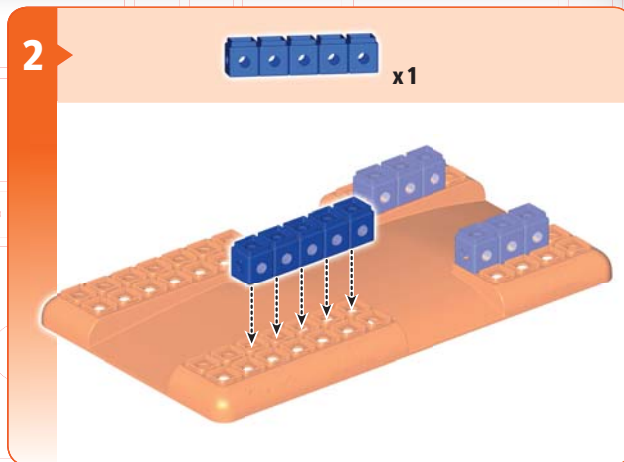
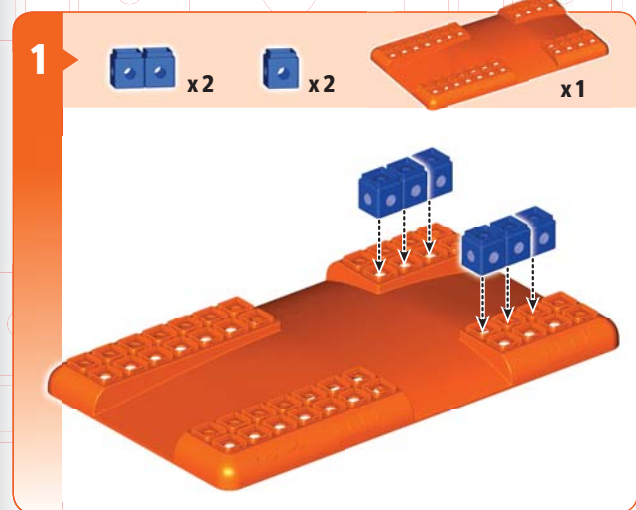

5

 x1

 x3

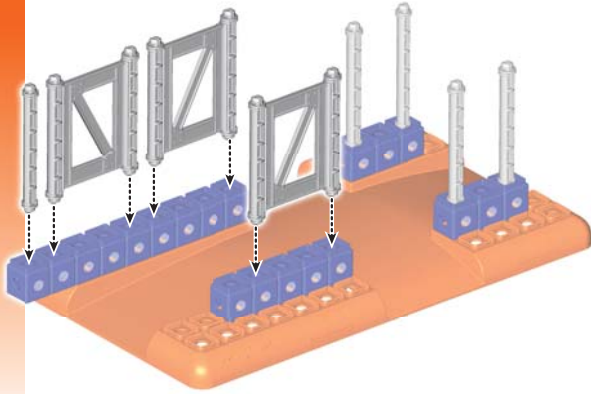

8

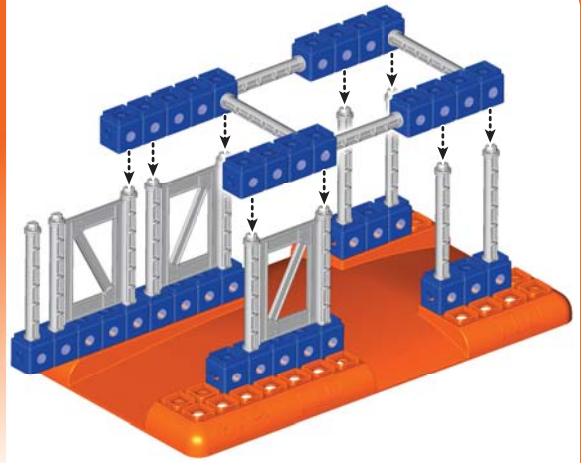

6

 x3

 x2

 x1

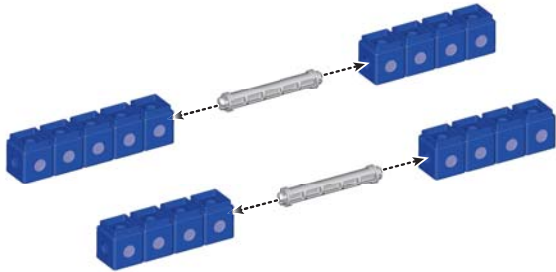

9

 x1

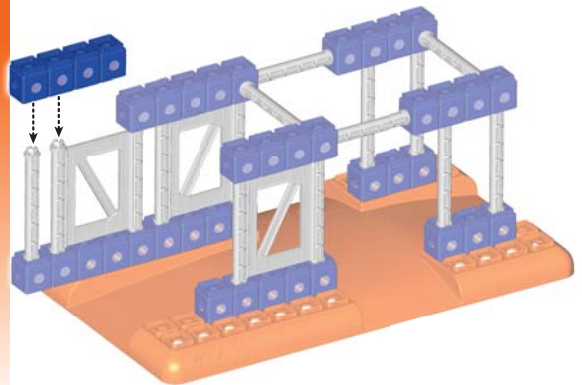

7

 x2

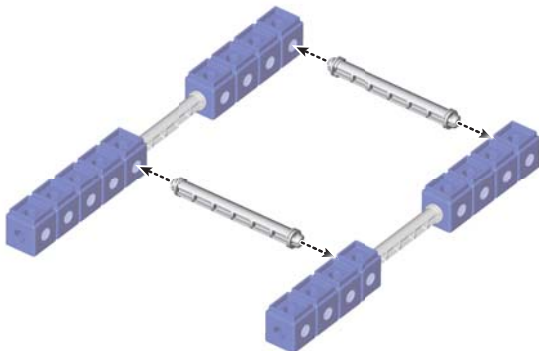

10

 x2

 x2

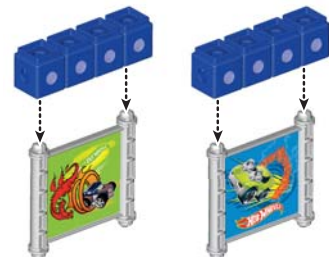

11



14

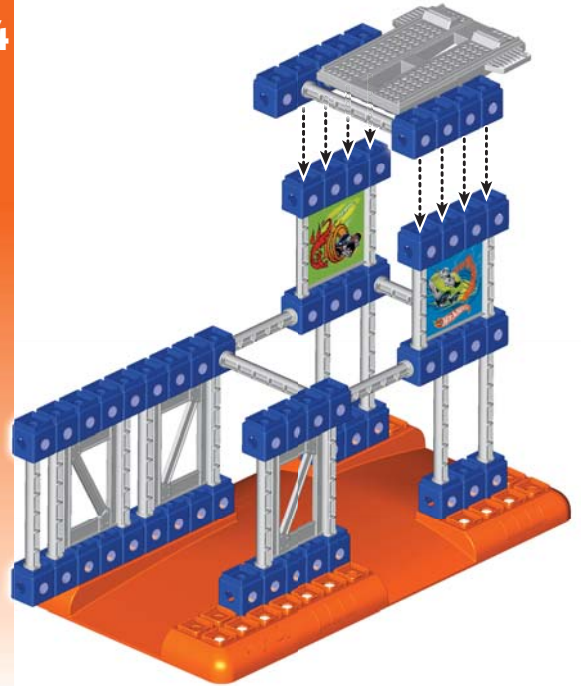

12

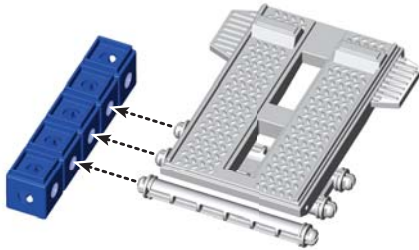

15

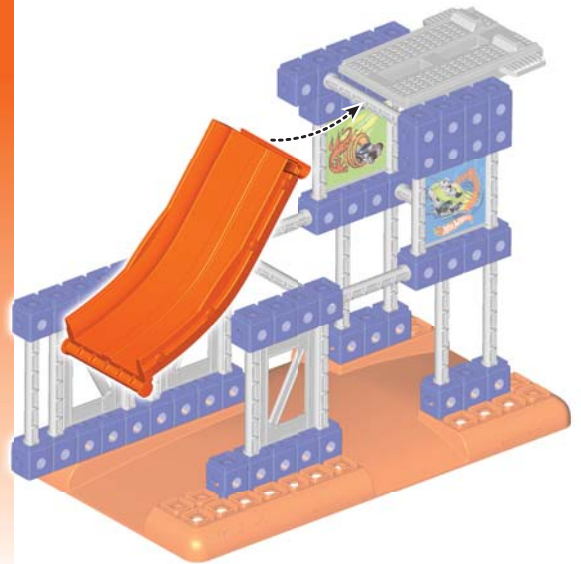

13

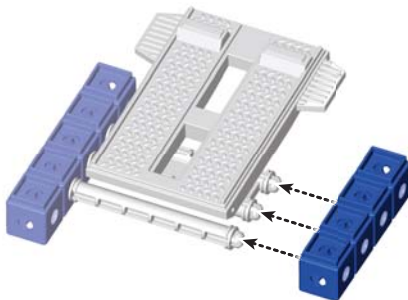

16

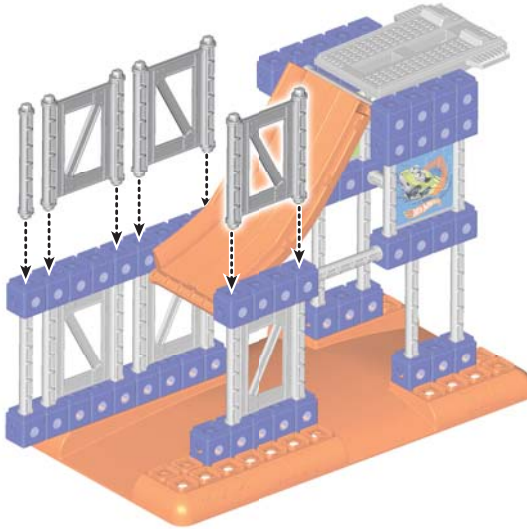

19

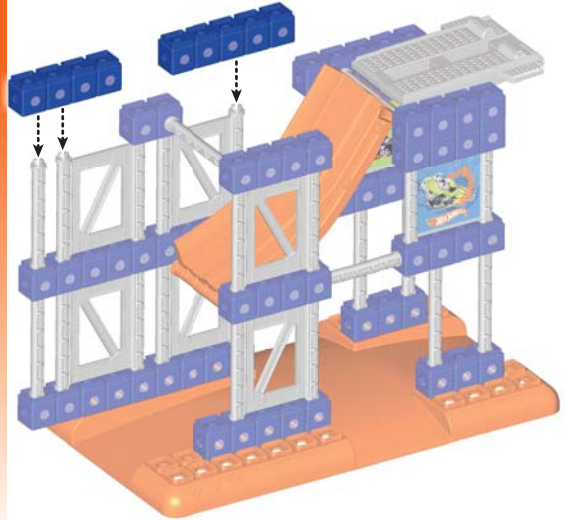

17



20

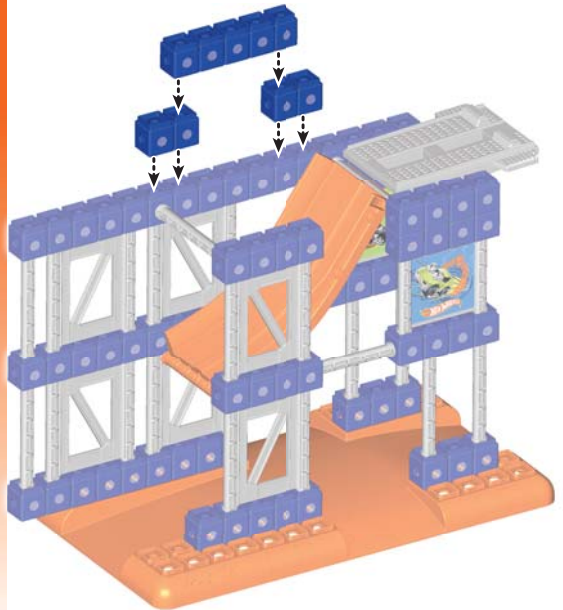

18



21

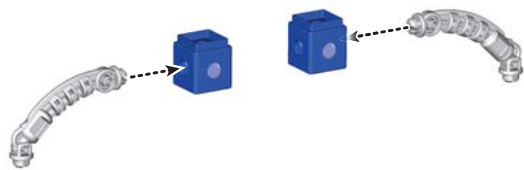

22



23

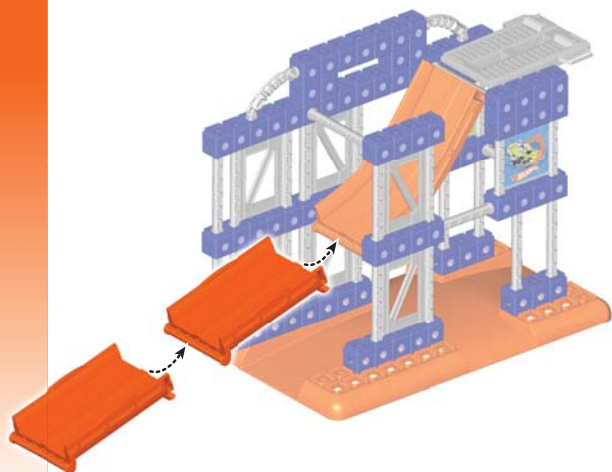

24

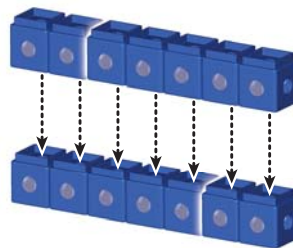

25



26

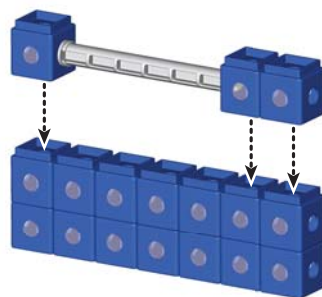

27

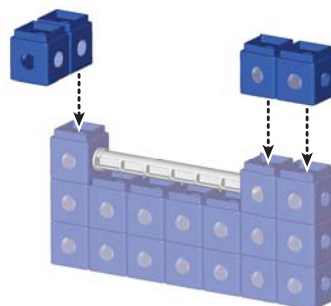

28

1x2 Blue Technic Brick x2    2x2 Blue Technic Brick x2    Grey Technic Arch x2

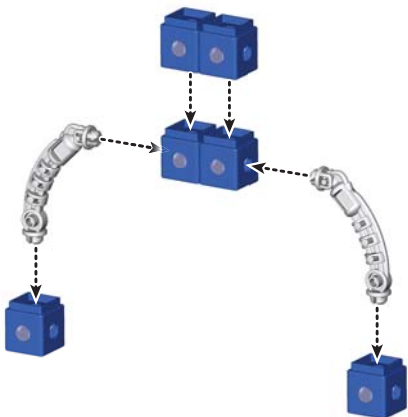

30

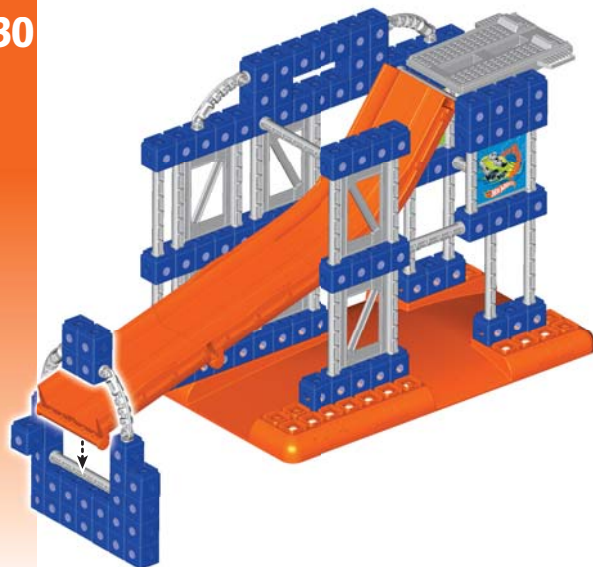

29

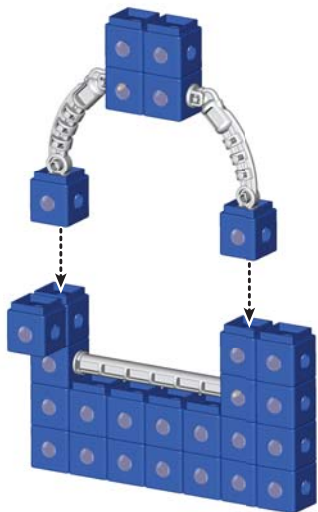

31

Orange Curved Slide x1    Orange Slide Support x1

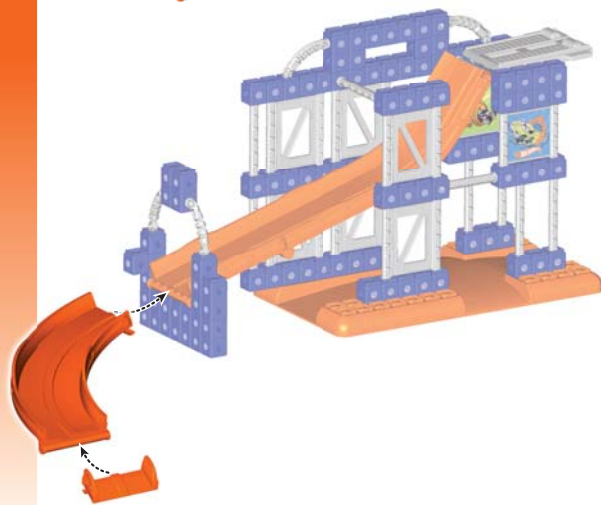

32

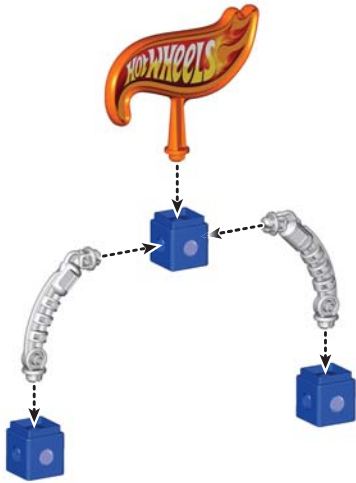
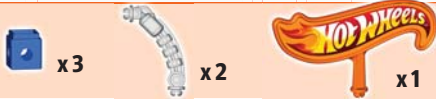

34



33



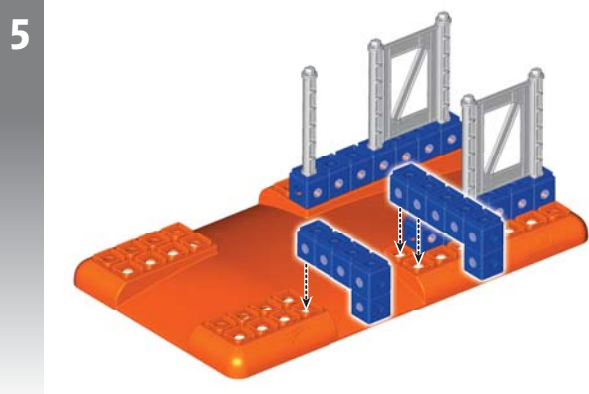
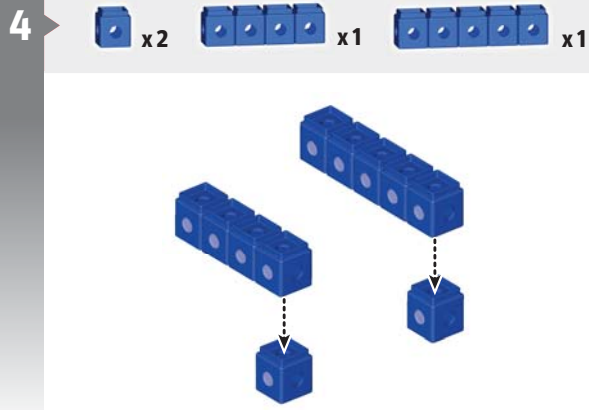
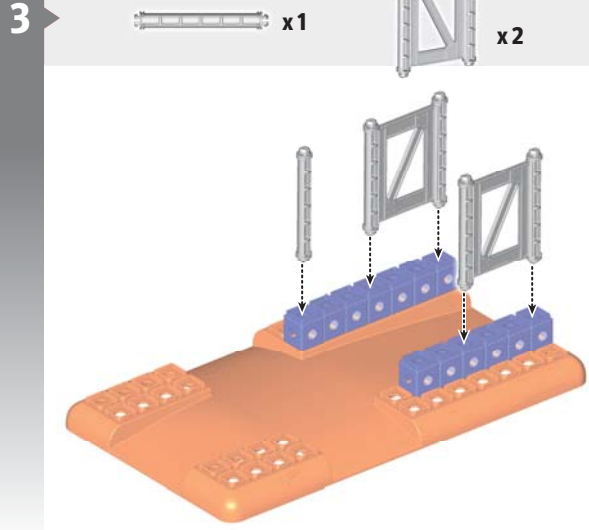
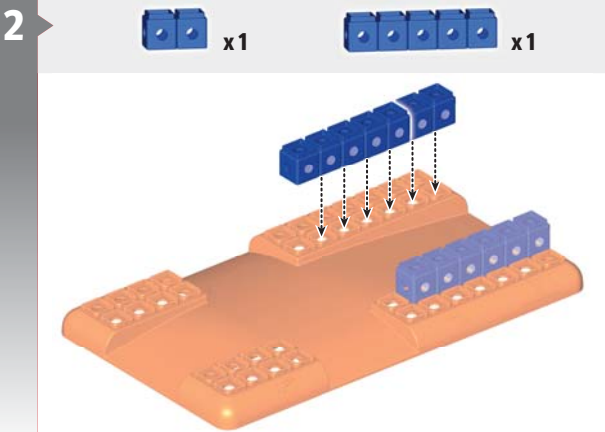
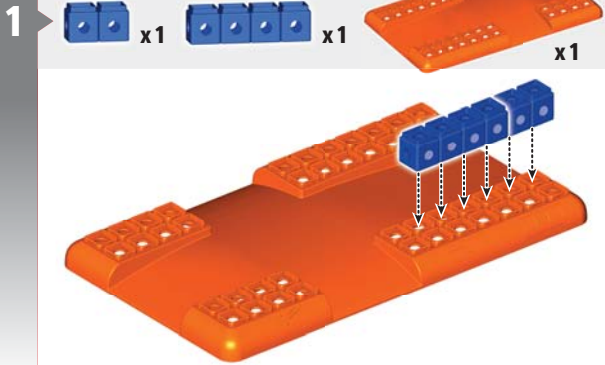



6

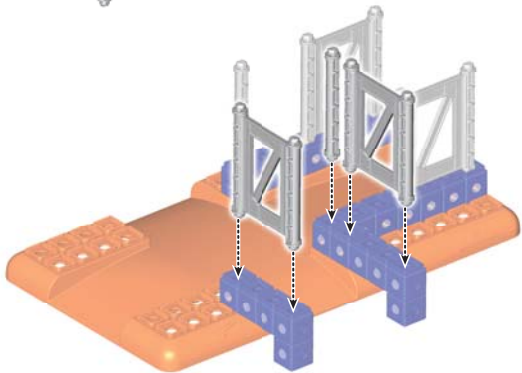
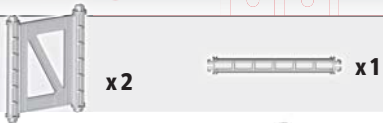

9

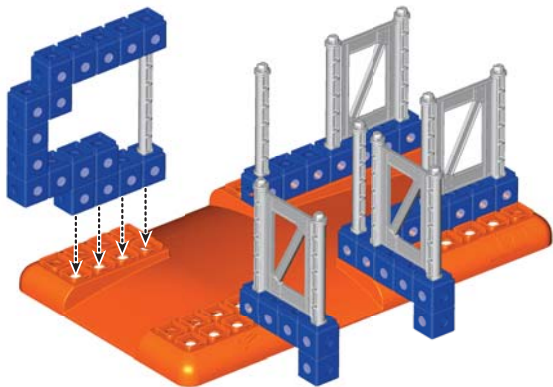

7

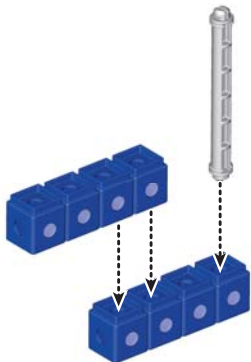
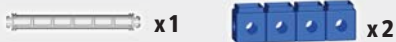

10

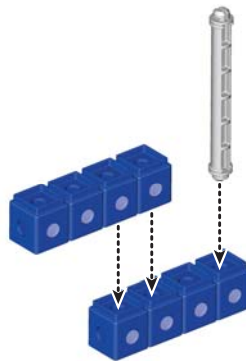
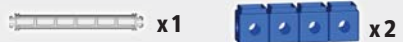

8

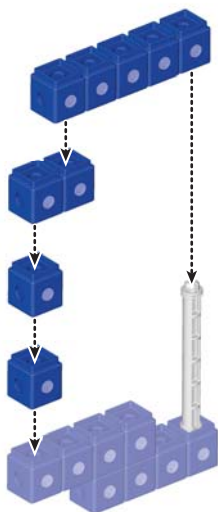

11

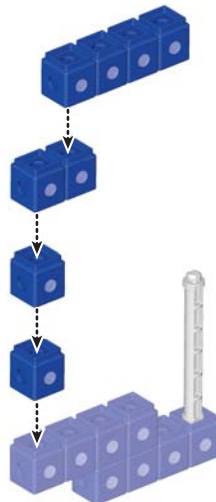

12

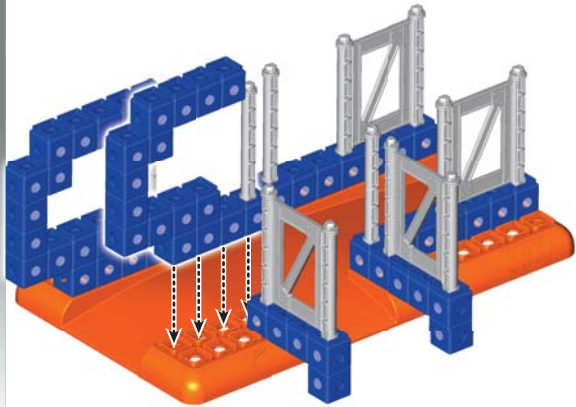

15

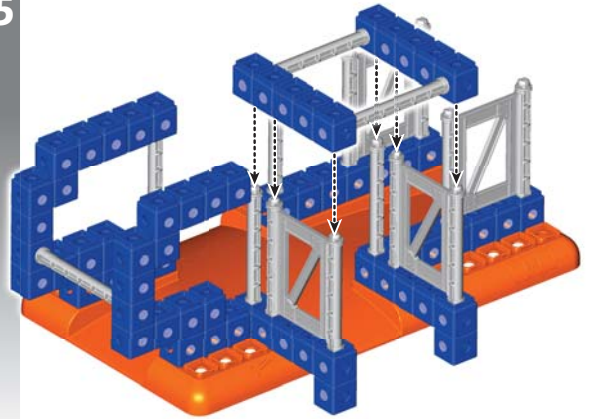

13



x1

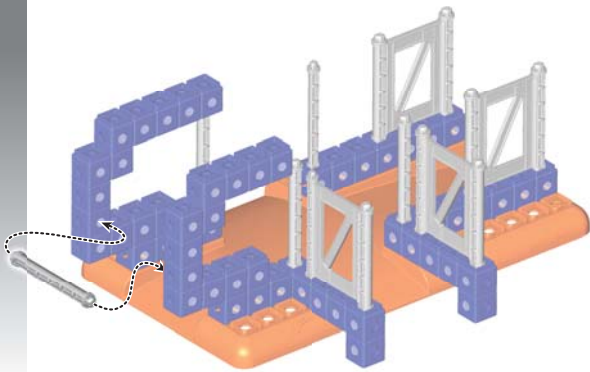

16



x2

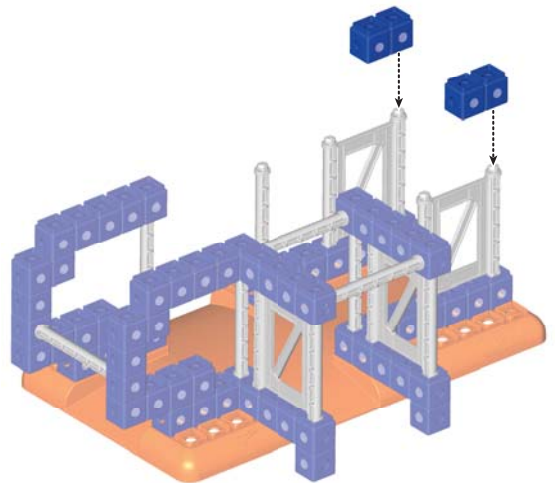

14



x2



x2

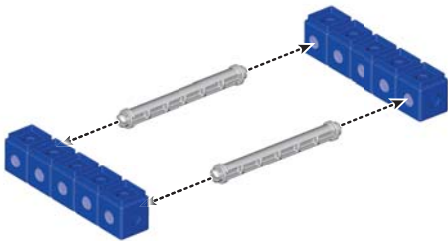

17



x1



x1

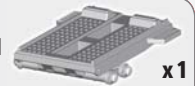

x1

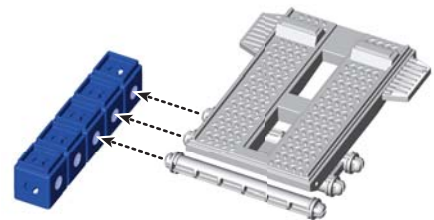

18

 x1

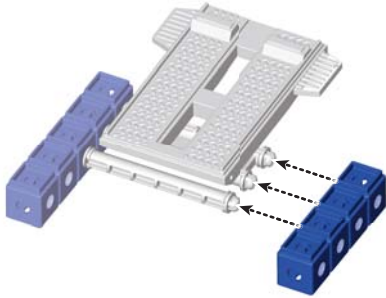

21

 x2

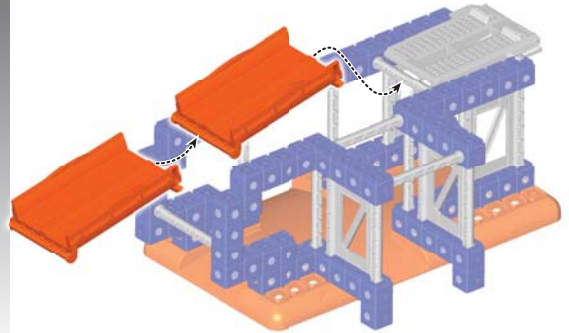

19

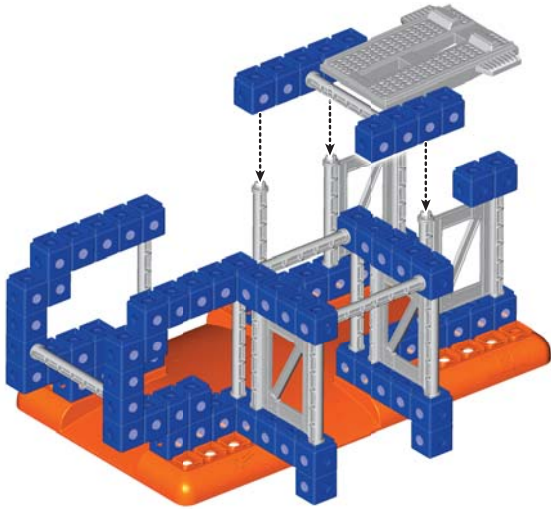

22

 x3

 x4

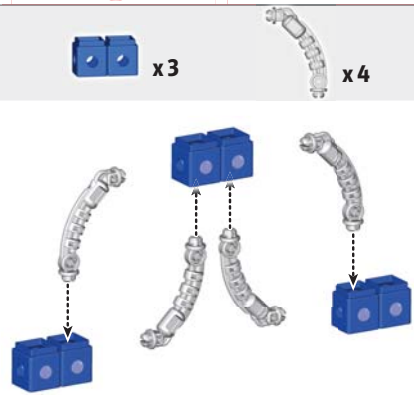

20

 x1

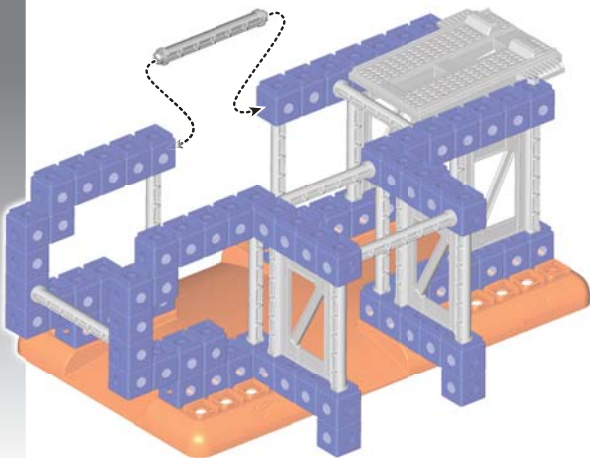

23

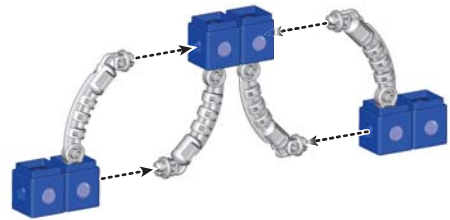

24

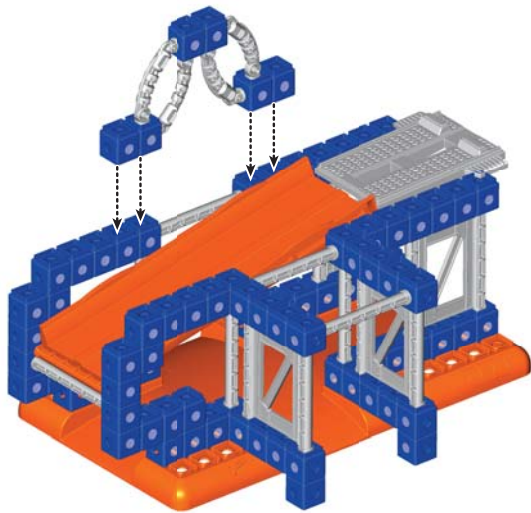

27

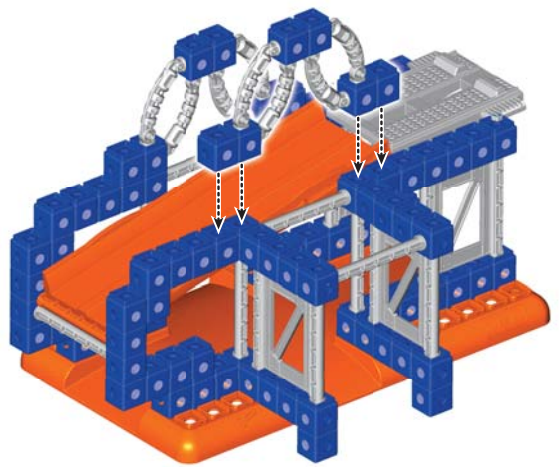

25

 x3    
  x4

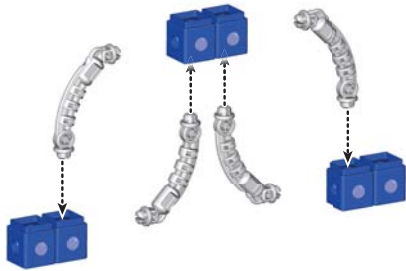

28

 x2    
  x2    
  x2

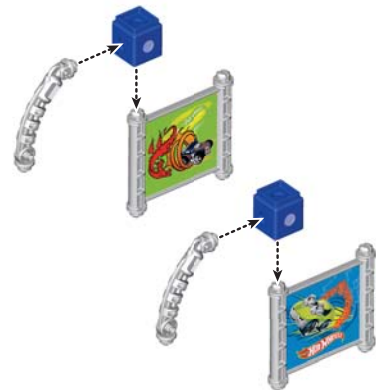

26



29

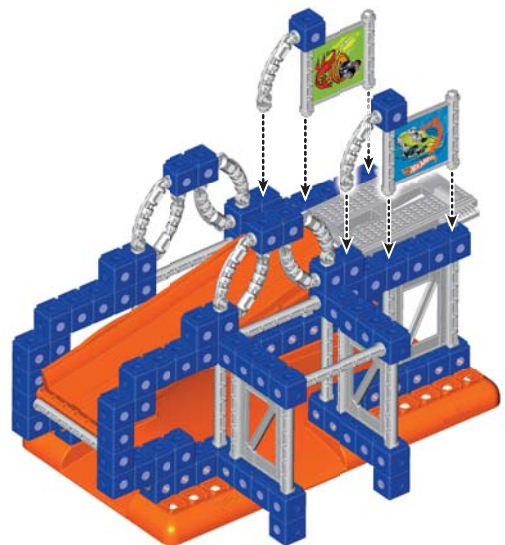

30

 x2

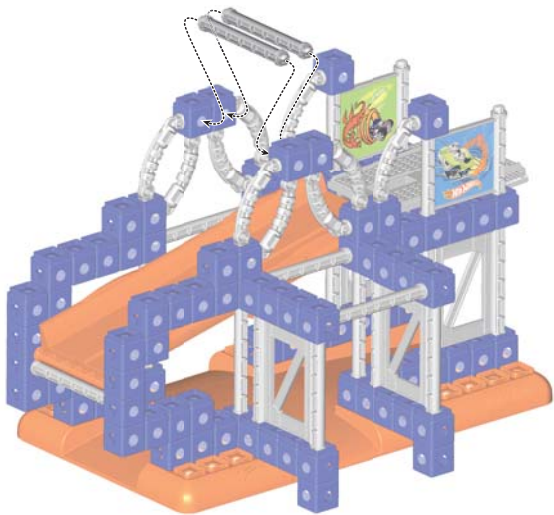

33

 x2

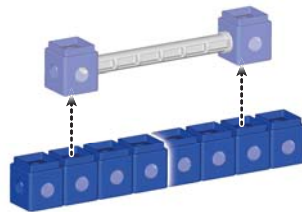

34

 x2

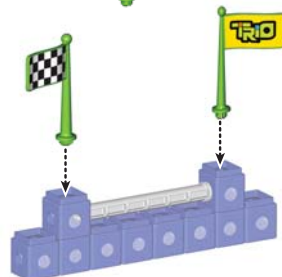

31

 x1

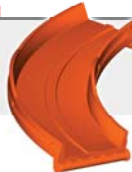

35

 x1

 x1



32

 x2

 x1



36





1

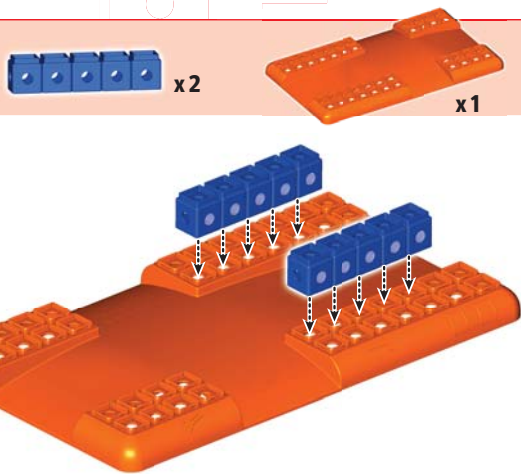

2

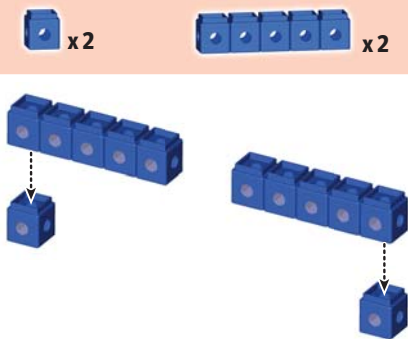

3

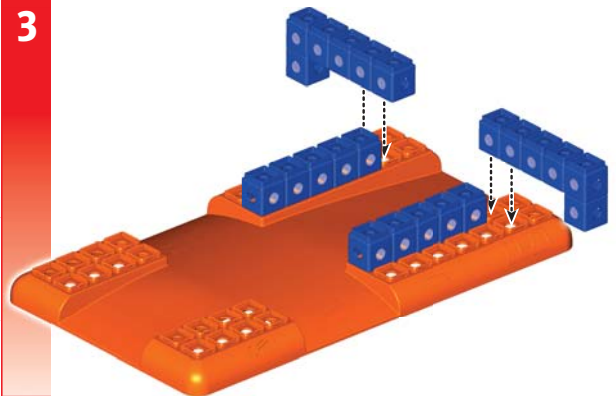

4

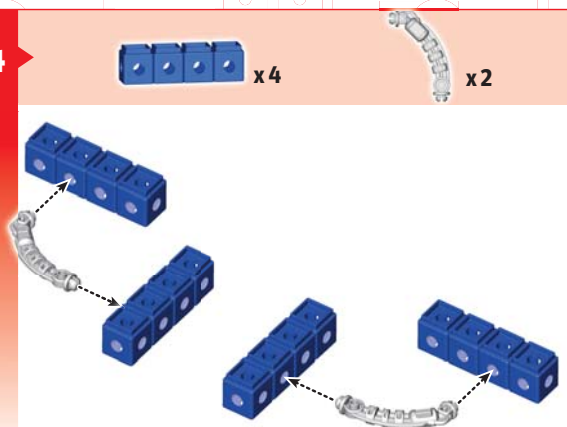

5

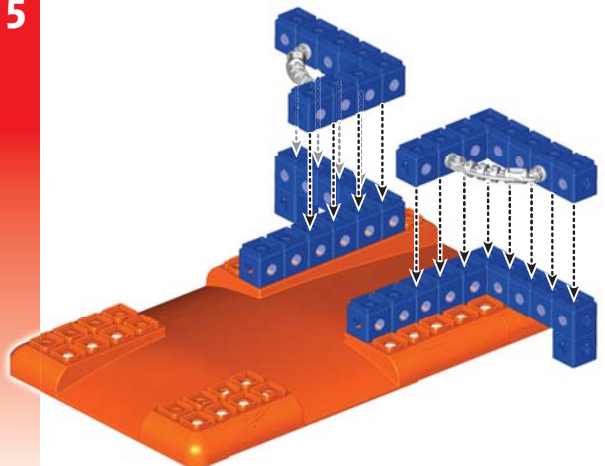

6

 x2

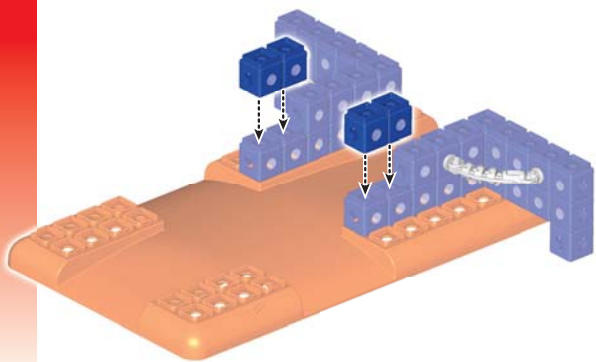

9

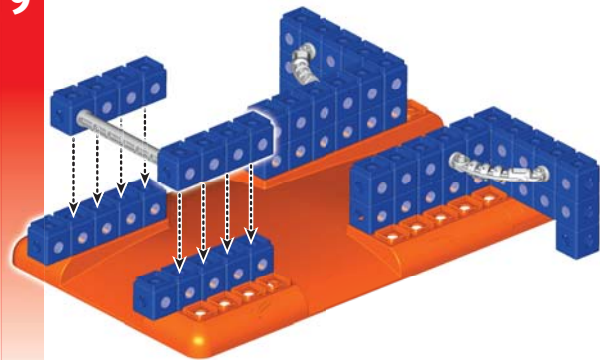

7

 x2

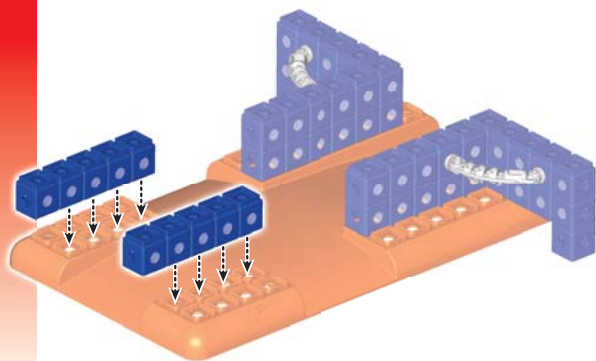

10

 x2     x2

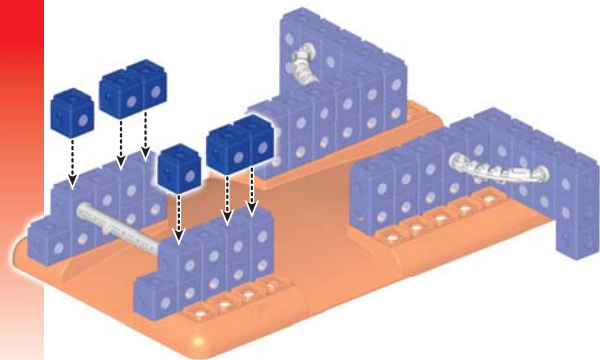

8

 x2     x1

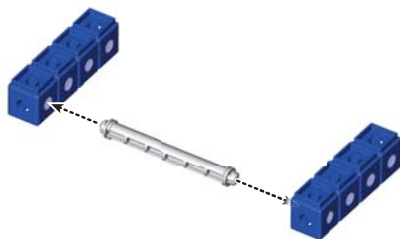

11

 x2

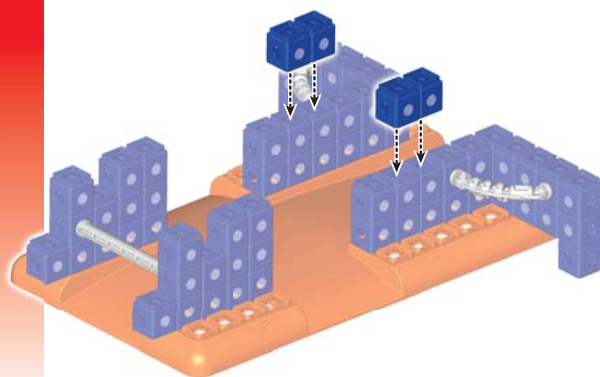

12

 x4

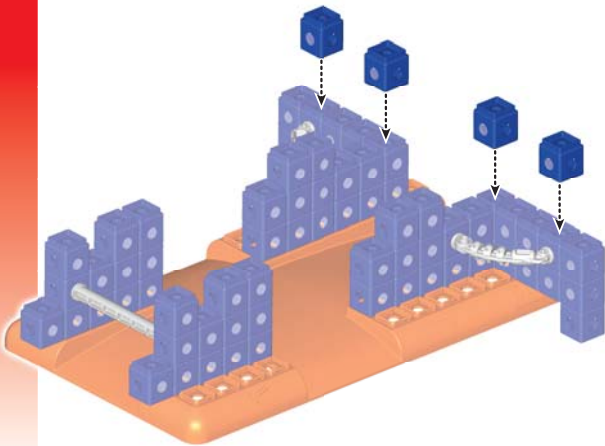

14

 x4

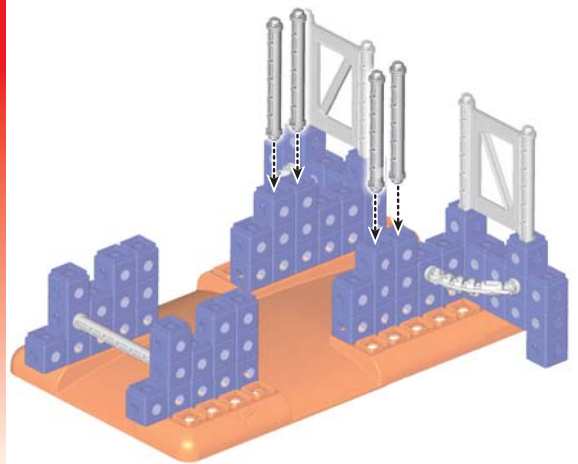

13

 x2

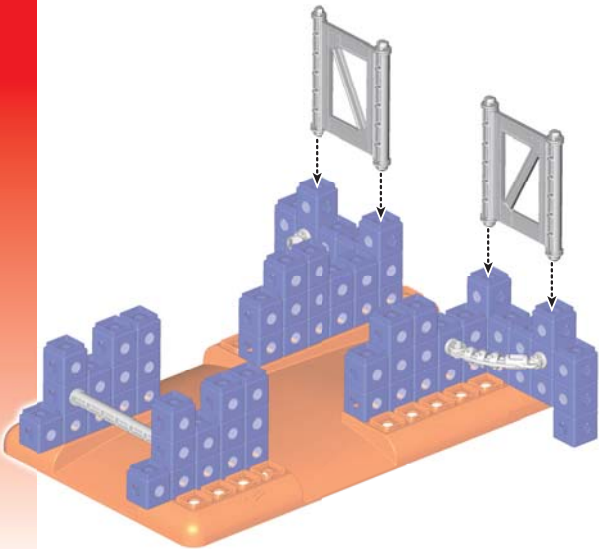

15

 x2

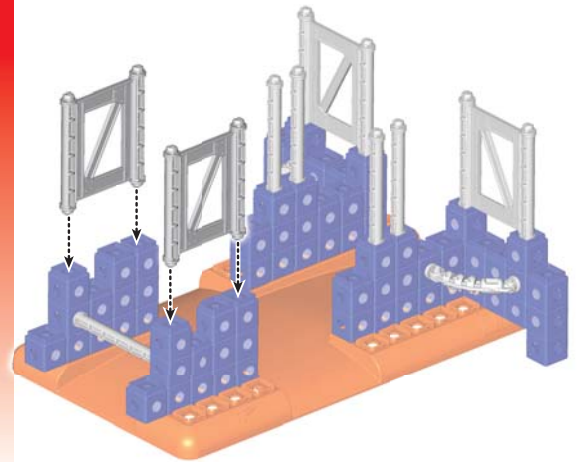

16

 x1  x1  x1





17

 x2

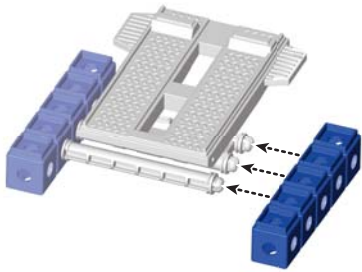

20

 x2       x2



18

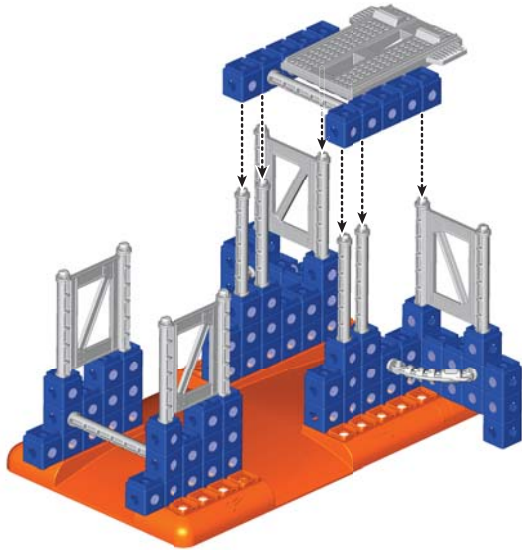

21

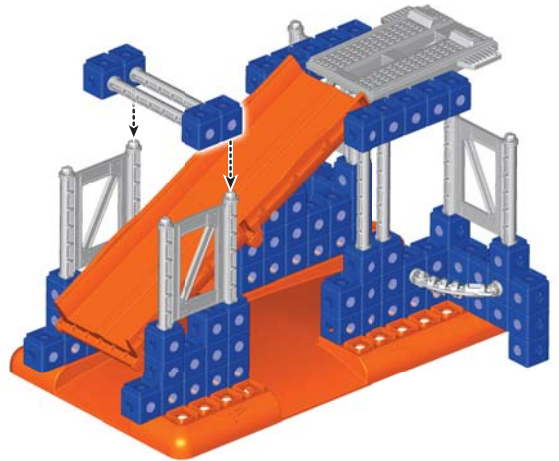

19

 x2

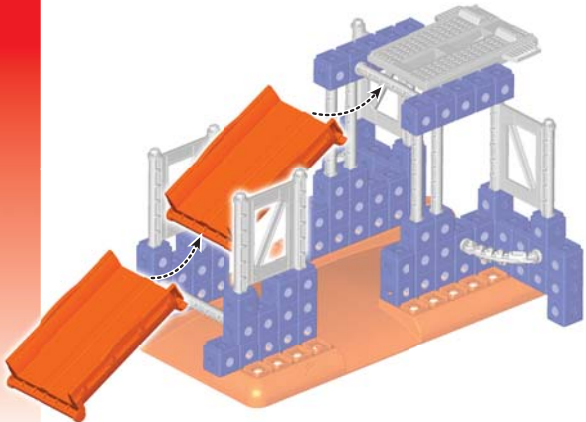

22

 x2       x4

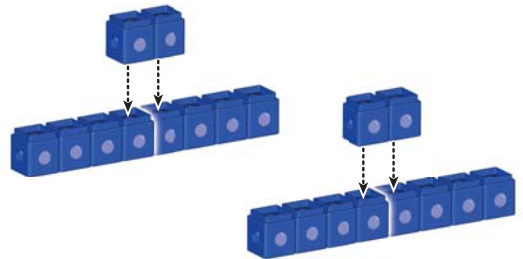

23

 x2

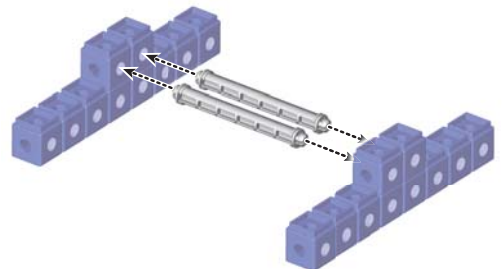

24

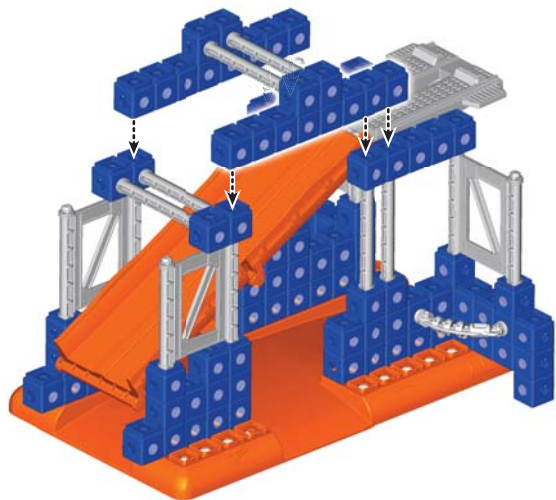

27

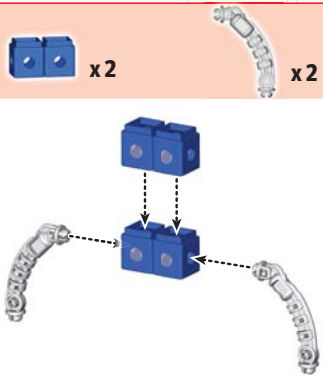

25

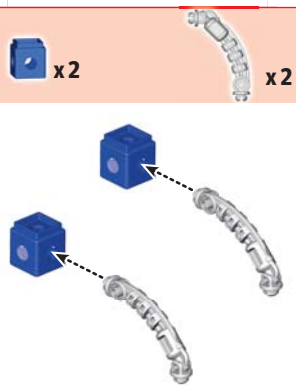

28

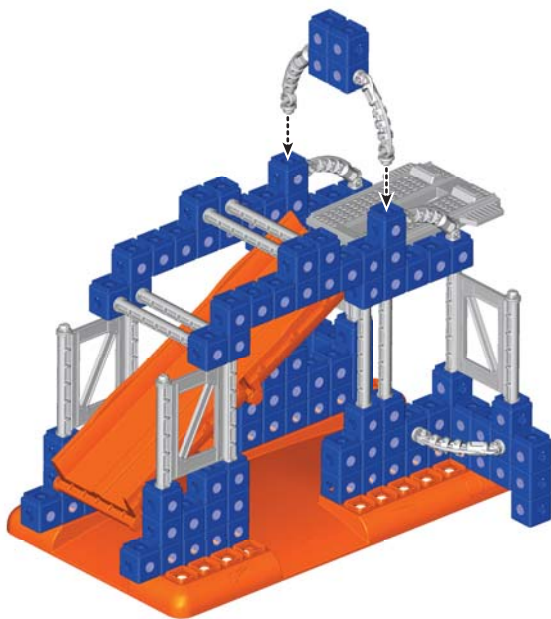

26

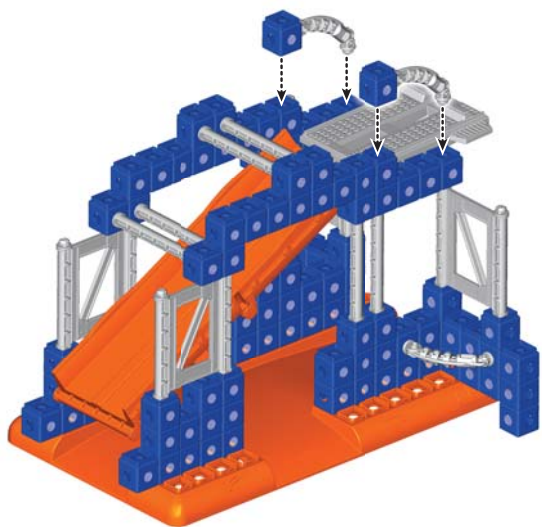

29

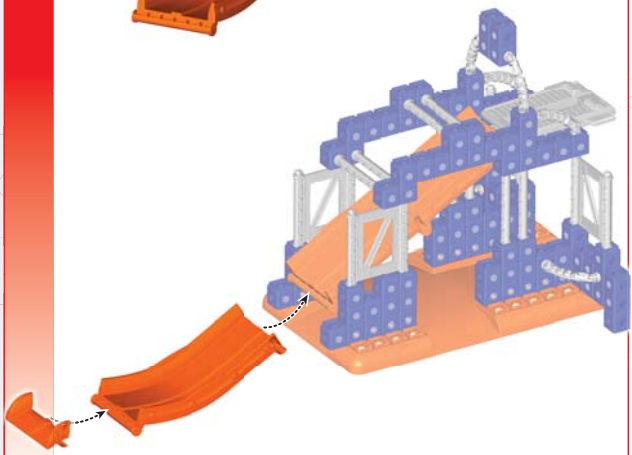
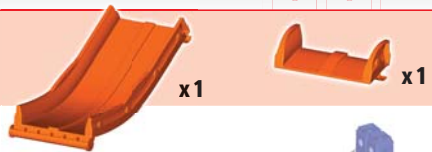

30

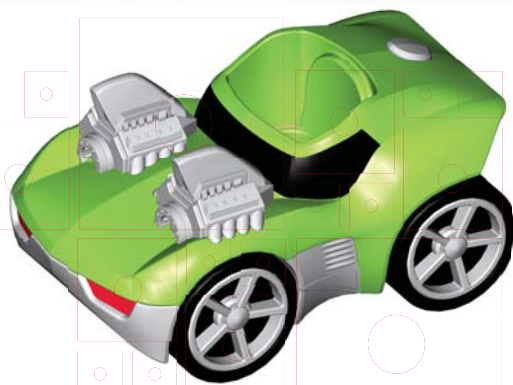

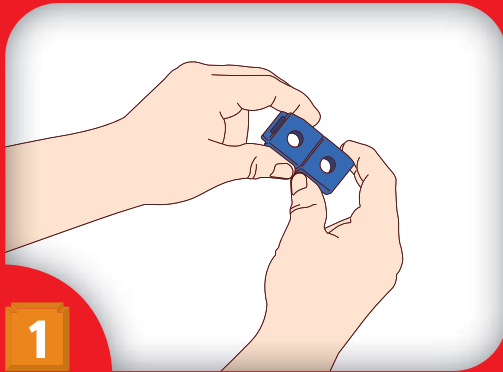

1

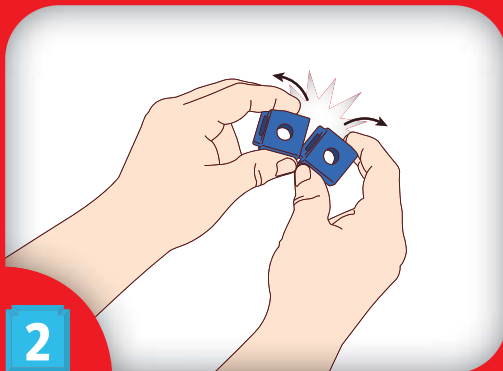

2

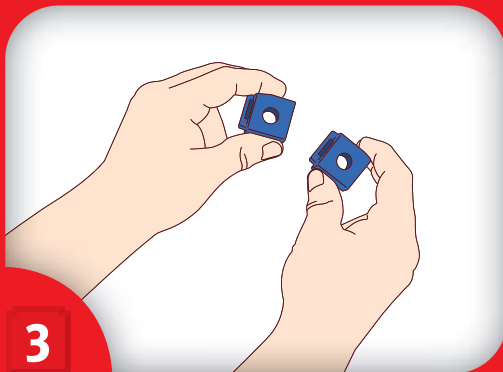

3

**UNITED STATES**

Questions? [www.service.fisher-price.com](http://www.service.fisher-price.com);  
1-800-432-5437. Write to us at: Fisher-Price®  
Consumer Relations, 636 Girard Avenue, East Aurora,  
NY 14052.

**CANADA**

Questions? [www.service.mattel.com](http://www.service.mattel.com); 1-800-432-5437.  
Mattel Canada Inc., 6155 Freemont Blvd., Mississauga,  
Ontario L5R 3W2.

**GREAT BRITAIN**

Mattel UK Ltd, Vanwall Business Park, Maidenhead SL6 4UB.  
Helpline: 01628 500303; [www.service.mattel.com/uk](http://www.service.mattel.com/uk).

**NEDERLAND**

Mattel Europa, B.V., Gondel 1, 1186 MJ,  
Amstelveen, Nederland.

**AUSTRALIA**

Mattel Australia Pty. Ltd., 658 Church Street,  
Locked Bag #870, Richmond, Victoria 3121 Australia.  
Consumer Advisory Service 1300 135 312.

**NEW ZEALAND**

16-18 William Pickering Drive, Albany 1331, Auckland.

**ASIA**

Mattel East Asia Ltd, Room 1106, South Tower,  
World Finance Centre, Harbour City, Tsimshatsui, HK, China.

**MALAYSIA**

Diimport & Diedarkan Oleh: Mattel SEA Ptd Ltd. (993532-P)  
Lot 13.5, 13th Floor, Menara Lien Hoe, Persiaran Tropicana  
Golf Country Resort, 47410 PJ. Tel: 03-78803817,  
Fax: 03-78803867.

**BRASIL**

Importado por : Mattel do Brasil Ltda.- CNPJ :  
54.558.002/0008-04 - Av. Tenente Marques, 1246 - Sala  
02 - 2º. Andar - 07770-000 - Polvilho - Cajamar - SP - Brasil.  
Serviço de Atendimento ao Consumidor (SAC):  
0800-550780 - [sac@mattel.com](mailto:sac@mattel.com).

Fisher-Price, Inc., a subsidiary of Mattel, Inc., East Aurora, NY 14052 U.S.A.  
©2011 Mattel, Inc. All Rights Reserved ® and ™ designate U.S. trademarks of Mattel, Inc.  
Fisher Price, Inc., une filiale de Mattel, Inc., East Aurora, NY 14052 É.-U.  
©2011 Mattel, Inc. Tous droits réservés. ® et ™ désignent des marques de Mattel, Inc. aux É.-U.

