

Fisher-Price

**W1392
BMM00**



Please keep this instruction sheet for future reference,
as it contains important information.

Requires three C batteries (LR14) **alkaline** batteries (not included) for operation.

Adult assembly is required.

Tool required for battery installation: Phillips screwdriver (not included).

Wipe this toy with a clean, damp cloth. Do not immerse.

This toy has no consumer serviceable parts. Do not take this toy apart.

fisher-price.com

Assembled Parts



Head



Tail



Spinner



Dome

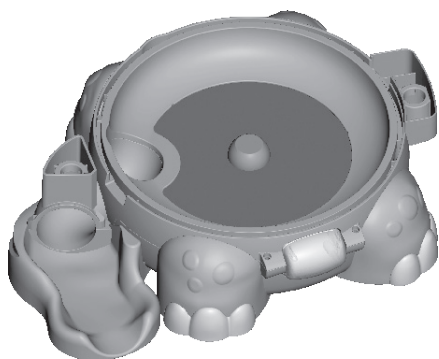

Base

Assembly

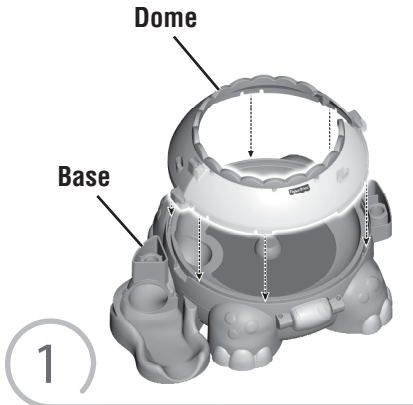

- “Snap” the dome onto the base.
Hint: The dome is designed to fit onto the base one way. If it does not seem to fit, turn it and try again.

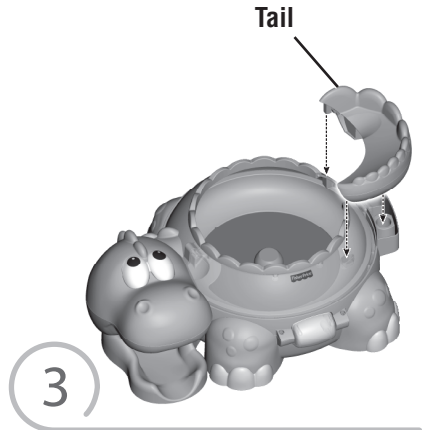

- Fit the tail onto the base. Push to “snap” in place.

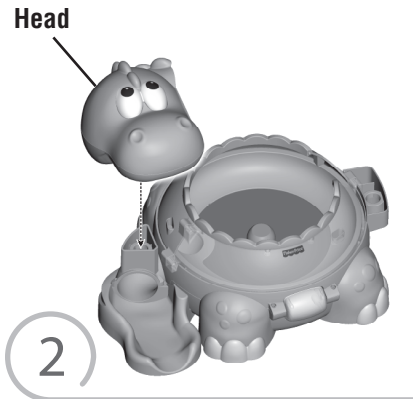

- Fit the head onto the base. Push to “snap” in place.

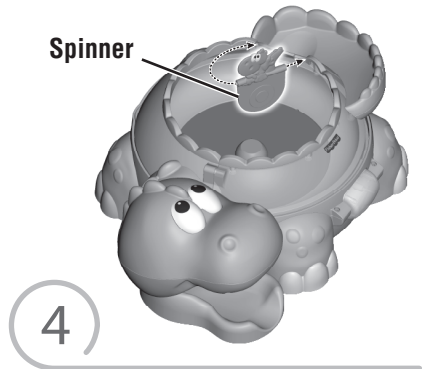

- At an angle, fit one end of the spinner into tail, as shown. Push to “snap” the other end of the spinner in place.

Consumer Information



CONSUMER ASSISTANCE
1-800-882-1837 (USA & Canada)
1-800-882-1837 (Outside US)

www.fisher-price.com

Fisher-Price, Inc., 838 Grand Avenue, East Aurora, NY 14045
Marketing/operational assistance: 1-800-882-1837

Outside the United States:

- Canada:** Metal Goods Inc., 6000 Avenue Du Parc, Mississauga, Ontario L4W 1G2; www.metalgoods.com.
- Great Britain:** Metal Goods Ltd, General Business Park, Watlington Road, Oxford, Oxfordshire OX2 0JG; www.metalgoods.com/uk.
- Mexico:** Europe S.A., Carretera a Llaneros 6000, Huixtla, Quintana Roo, Mexico; P.O. Box 100, Ciudad de México, México DF 06700; www.fisher-price.com/mexico.
- New Zealand:** 65-68 Williams Park Drive, Albany 6100, Auckland.

FCC Statement (United States Only)

This equipment has been tested and found to comply with the limits for a Class B digital device, pursuant to Part 15 of the FCC Rules. These limits are designed to provide reasonable protection against harmful interference in a residential installation. This equipment generates, uses and can radiate radio frequency energy and, if not installed and used in accordance with the instructions, may cause harmful interference to radio communications. However, there is no guarantee that interference will not occur in a particular installation. If this equipment does cause harmful interference to radio or television reception, which can be determined by turning the equipment off and on, the user is encouraged to try to correct the interference by one or more of the following measures:

- Reorient or relocate the receiving antenna.
- Increase the separation between the equipment and receiver.
- Consult the dealer or an experienced radio/TV technician for help.

Note: Changes or modifications not expressly approved by the manufacturer responsible for compliance could void the user's authority to operate the equipment.

This device complies with Part 15 of the FCC Rules. Operation is subject to the following two conditions: (1) this device may not cause harmful interference and (2) this device must accept any interference received, including interference that may cause undesired operation.

ICES-003

- This Class B digital apparatus complies with Canadian ICES-003. Operation is subject to the following two conditions: (1) this device may not cause harmful interference and (2) this device must accept any interference received, including interference that may cause undesired operation.

NMB-003

- Cet appareil numérique de la classe B est conforme à la norme NMB-003 du Canada. L'utilisation de ce dispositif est autorisée seulement aux conditions suivantes: (1) il ne doit pas produire de brouillage et (2) l'utilisateur du dispositif doit être prêt à accepter tout brouillage radioélectrique reçu, même si ce brouillage est susceptible de compromettre le fonctionnement du dispositif.

Battery Installation

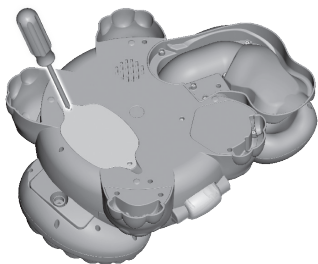
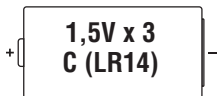

- For longer life, use **alkaline** batteries.
- Locate the battery compartment door on the bottom of the dino base.
- Loosen the screws in the battery compartment door and remove the door.
- Insert three, new C (LR14) **alkaline** batteries.
- Replace the battery compartment door and tighten the screws.
- If this toy begins to operate erratically, you may need to reset the electronics. Slide the power/volume switch off and then back on.
- When sounds or motion from this toy become faint or stop, it's time for an adult to change the batteries.



- Protect the environment by not disposing of this product with household waste (2002/96/EC). Check your local authority for recycling advice and facilities.

Battery Safety Information

In exceptional circumstances, batteries may leak fluids that can cause a chemical burn injury or ruin your product. To avoid battery leakage:

- Do not mix old and new batteries or batteries of different types: alkaline, standard (carbon-zinc) or rechargeable (nickel-cadmium).
- Insert batteries as indicated inside the battery compartment.
- Remove batteries during long periods of non-use. Always remove exhausted batteries from the product. Dispose of batteries safely. Do not dispose of this product in a fire. The batteries inside may explode or leak.
- Never short-circuit the battery terminals.
- Use only batteries of the same or equivalent type, as recommended.
- Do not charge non-rechargeable batteries.
- Remove rechargeable batteries from the product before charging.
- If removable, rechargeable batteries are used, they are only to be charged under adult supervision.

Ball-popping Action!





Power/Volume Switch



Roll a ball
down the
tail ramp

Spin the roller

-
- Slide the power/volume switch to ON with low volume  or ON with high volume .
 - Spin the roller on the front of the dino.
 - Roll a ball down the dino's tail or drop it in the base to see it bounce around inside the dino, pop out or roll out his mouth!
 - When you are finished playing with this toy, slide the power/volume switch OFF .