

TMH®

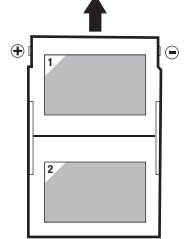
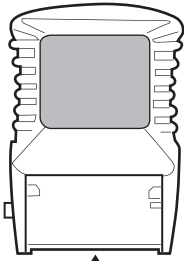

1250mAh

BATTERY CHARGING/CARE

⚠ CAUTION: Use only the charger supplied with this toy. Do not use any other charging source.

Use only HOT WHEELS® R/C TMH® FlexPak® NiMH battery packs. Other batteries may leak or rupture, causing personal injury and damage.

1. Plug the battery charger into standard wall outlet.
2. Hold the battery pack fully open, with the metal contacts at the top, as shown. The labels marked 1 and 2 in the upper left-hand corner should be facing you. Now slide the battery pack securely into the charger.
3. To disconnect, push the red button on the side of the charger. Hold the red button down while you slide out the battery pack.
4. After charging, the battery pack may feel warm. This is normal for fully charged batteries.
5. New battery packs must be charged for 5 1/2 hours the first two times charged. After that, subsequent charges will require 4 hours. Charging the battery pack for more than 4 hours will not give you a longer running time. 4 hours is all that is required for a fully charged battery pack.
6. Unlike NiCd (Nickel-Cadmium) rechargeable batteries, your TMH® FlexPak® battery pack may be recharged at any time irrespective of the level of charge remaining in the battery. You do not have to wait until the battery pack is fully discharged to recharge it.
7. After use, the battery pack will be hot! Wait at least 20 minutes until the battery pack cools down before recharging. Recharging a hot battery will greatly reduce the number of times your battery pack can be recharged.

RECHARGEABLE BATTERY INFORMATION:

- DO NOT RECHARGE BATTERY PACK IF IT IS HOT. ALLOW IT TO COOL BEFORE RECHARGING.
- DO NOT RECHARGE A BATTERY PACK THAT SHOWS LEAKAGE OR CORROSION.
- DO NOT DISASSEMBLE THE BATTERY PACK. THE BATTERY PACK IS A SEALED RECHARGEABLE NICKEL-METAL HYDRIDE BATTERY PACK.
- EXERCISE CAUTION IN HANDLING A HOT BATTERY PACK.
- IF BATTERY PACK AND/OR CHARGER ARE WET, THOROUGHLY DRY BEFORE CHARGING.
- DO NOT RECHARGE NON-RECHARGEABLE BATTERIES.
- DO NOT DISPOSE OF THE BATTERY PACK IN A FIRE.

Note to Adults:

- Recharge battery pack only under adult supervision.
- Periodically examine this product for damage to the plug, housing, or other parts that may result in the risk of fire, electric shock or injury. If the product is damaged, do not use it.
- The transformer is not a toy.
- This battery charger is intended to be correctly oriented in a vertical or floor mount position

BATTERY DISPOSAL

Unlike NiCd (Nickel-Cadmium) rechargeable batteries, your TMH® FlexPak® NiMH battery pack requires no special procedures or precautions for disposal. However, as with all products, you should dispose of your battery pack in an environmentally responsible and considerate manner.

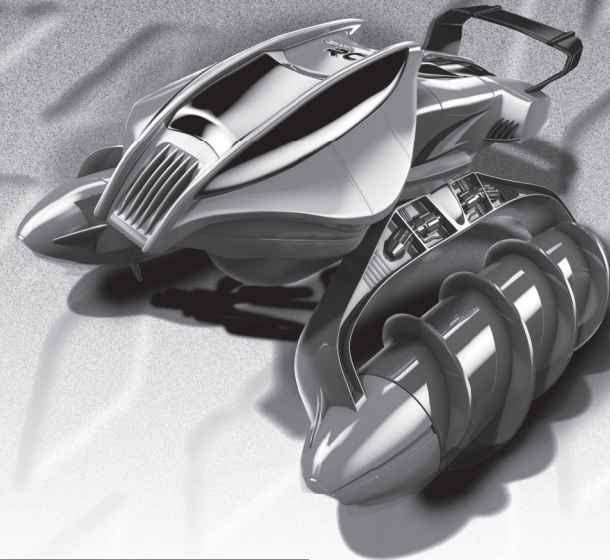
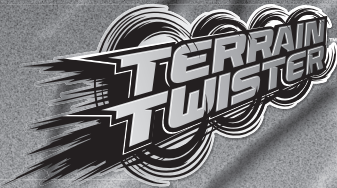

8+ Asst. X2874 X2875/ X2876-0920

CAUTION – ELECTRICALLY OPERATED PRODUCT:
NOT RECOMMENDED FOR CHILDREN UNDER 8 YEARS OF AGE. AS WITH ALL ELECTRIC PRODUCTS, PRECAUTIONS SHOULD BE OBSERVED DURING HANDLING AND USE TO PREVENT ELECTRIC SHOCK.
INPUT: 120VAC 60Hz 0.11A.
OUTPUT: 8.5VDC 370mA 3.2VA

Keep these instructions for future reference as they contain important information. **IMPORTANT:** Please read all “Consumer Information” before operating your vehicle.

⚠ CAUTION: To prevent entanglement, keep all hair away from moving parts.

I. CONTENTS/ FEATURES

- | | |
|--------------------|--------------------|
| ① Vehicle | ② Transmitter |
| ① Battery door | ① Driving controls |
| ② ON/OFF switch | ② Battery Door |
| ③ Twin PowerScrews | ③ Antenna |

SMART CIRCUITRY

Your new vehicle is equipped with advanced “Smart Circuitry” designed to protect its electronic components under extreme operating conditions. If your vehicle stalls or gets stuck during use, it will automatically power down. Simply release the transmitter controls for a few seconds, then press the left control to resume normal operation.

NOTE: When your vehicle powers up again, you may notice some movement of the vehicle body and the PowerScrews. This may also happen if the vehicle is switched off with the PowerScrews angled, and then turned back on. This is completely normal: it's an automatic system designed to return the vehicle to normal driving position. Once the movement has stopped, you may simply resume normal operation.

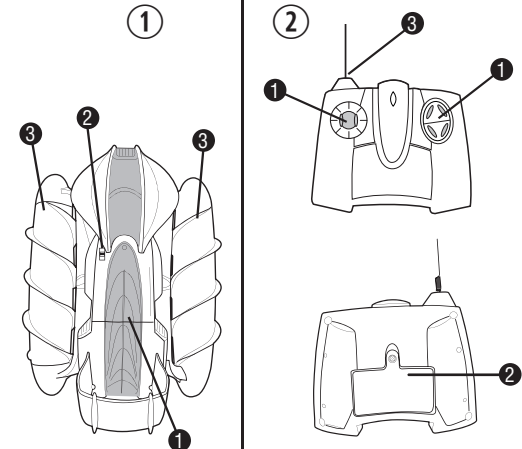

Protect the environment by not disposing of this product with household waste (2002/96/EC). Check your local authority for recycling advice and facilities.



Questions or problems with your product? **DON'T RETURN IT TO THE STORE!** Just call us for help.

U.S. consumers may also register their products at this number.

©2012 Mattel. All Rights Reserved. Mattel, Inc., 636 Girard Avenue, East Aurora, NY 14052, U.S.A. Consumer Relations 1-888-557-8926. Mattel U.K. Ltd., Vanwall Business Park, Maidenhead SL6 4UB. Helpline 01628 500303. Mattel Australia Pty., Ltd., Richmond, Victoria. 3121.Consumer Advisory Service - 1300 135 312. Mattel East Asia Ltd., Room 1106, South Tower, World Finance Centre, Harbour City, Tsimshatsui, HK, China. Diimport & Diedarkan Oleh: Mattel SEA Ptd Ltd.(993532-P) Lot 13.5, 13th Floor, Menara Lien Hoe, Persiaran Tropicana Golf Country Resort, 47410 PJ. Tel:03-78803817, Fax:03-78803867. service.mattel.com

II. ALL TERRAIN, ALL THE TIME!

- Your vehicle is engineered for amazing multi-direction driving... on land, in water and over just about any kind of terrain! Driving and stunt capabilities will vary depending on the driving surface. Keep reading for detailed information.
- The left control moves in eight different directions to control your vehicle's direction of movement.
- The right control controls the angle of the PowerScrews.
- With practice, you'll discover that the two transmitter controls work together to give you complete control over your vehicle. These graphics show you how the controls work.

1 BASIC DRIVING

The PowerScrews are engineered for great straight-ahead driving performance on many surfaces. However, smooth surfaces – like sidewalks, asphalt, tile, or hard flooring – don't provide enough traction for straight-ahead driving. On this kind of surface, simply use "sidewinder" driving.

2 POWERSCREW OPERATION

3 ADVANCED OPERATION

4 SPECIAL WATER STUNTS

Your vehicle is designed to do super-cool 360° spins in the water! This is a water-only stunt – on land, these control operations will give you cool "sidewinder" driving action.

PRO DRIVING TIPS

- On low-pile carpeting, your vehicle may sometimes drift or slide to one side when driving straight. This is a result of the advanced design of the PowerScrews and it's completely normal. To regain control, simply steer left or right...or else release the transmitter controls for a moment, and then resume driving.
- When driving in snow, turning performance may vary depending on the depth and wetness of the snow. For the best results, you may want to turn your vehicle by tapping or pulsing the transmitter controls.
- Your vehicle is engineered to drive right from one kind of terrain to another. Of course, it may not be able to do that if the transition from one surface to another is too steep or difficult. In that situation, simply pick up the vehicle and reposition it...for more all-terrain action!

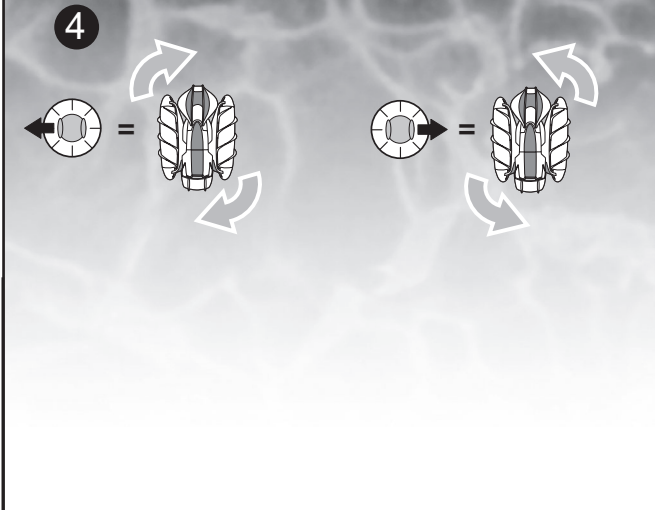
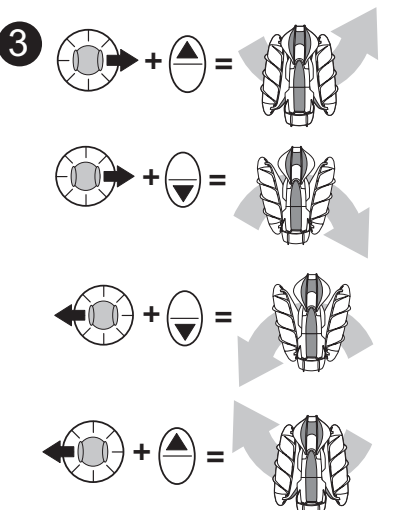
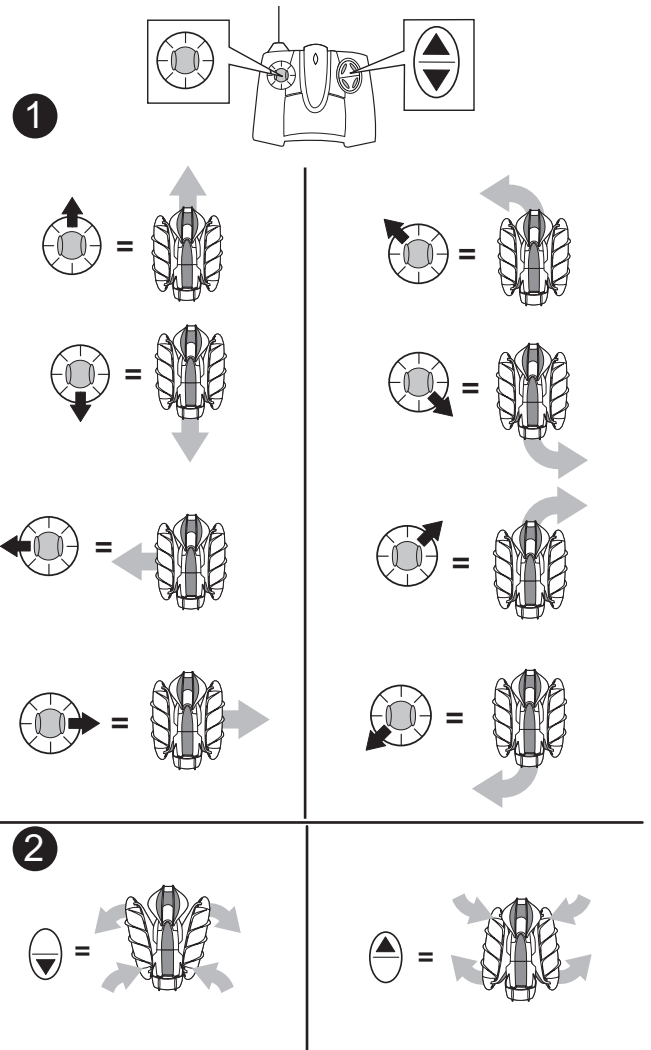

III. BATTERY INSTALLATION

- Vehicle**
1. Unscrew the battery door with a Phillips head screwdriver (not included). Swing the battery door up and away from the vehicle.
2. Fold the TMH® FlexPak® battery pack into an "L" shape, as shown. Check the labels marked 3 and 4, to make sure they match the illustration.
3. Insert the horizontal portion of the battery pack (label 3) into the battery compartment as shown. Push it all the way into the battery compartment (toward the back of the vehicle). You'll feel it click into place.
4. Fold down the vertical portion of the battery pack (label 4), as shown. Make sure the battery pack is folded all the way down.
5. Replace the battery door and tighten screw.
6. To remove the battery door: Unscrew and remove the battery door. Lift the top portion of the battery pack (label 4) into a vertical position. Slide the battery pack toward the front of the vehicle to release, and lift out the battery pack.

FOR DETAILED INFORMATION REGARDING VEHICLE BATTERY CHARGING AND SAFETY, PLEASE FOLLOW THE "BATTERY CHARGING/CARE" INSTRUCTIONS LOCATED ON THE BACK PAGE.

2 Transmitter

- Unscrew the battery door with a Phillips head screwdriver (not included). Swing the battery door up and away from the transmitter.
- Transmitter requires 2 AA alkaline batteries. Install with polarity (+/-) as shown inside the battery compartment.
- Replace the battery door and tighten screw.

IV. TIPS & HINTS

TIPS & HINTS – FOR ALL DRIVING ENVIRONMENTS

- When your vehicle starts to lose power, it may lose functions or performance. It's time for a recharge. For best stunt performance, always start with a fully-charged battery. Your vehicle's running time may change depending on driving style and driving environment.
- Radio interference can make your vehicle run badly. Interference can be caused by other R/C vehicles running on the same frequency; electrical wires; large buildings; CB radios; or other wireless gear. Try to stay away from these!
- Point your transmitter antenna up - not down toward your vehicle. If your vehicle gets too far away, it won't work properly.
- Don't store your vehicle near heat or in direct sunlight. Always turn switches OFF and remove all batteries for storage.
- After each use, remove any water, moisture, dirt or mud from the vehicle, using a clean dry cloth. Make sure the vehicle is fully drained of water, and allow the vehicle to air-dry completely after use.

TIPS & HINTS – FOR WATER OPERATION

- Operate your vehicle only in calm, clear water. Pools and shallow ponds are recommended. DO NOT OPERATE IN SALT WATER. Do not expose vehicle to water unless the battery compartment is properly closed.
- After a few minutes of water operation, you should pay close attention to your vehicle's location, making sure that it's close to the water's edge. That way your vehicle will be able to return safely under its own power.

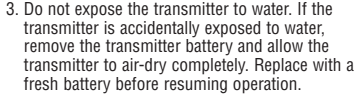
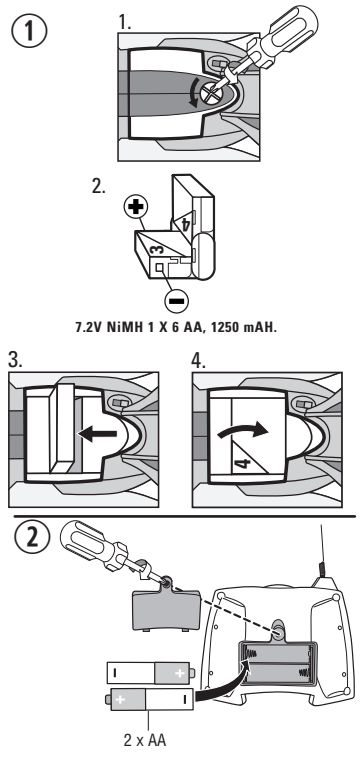

3. Do not expose the transmitter to water. If the transmitter is accidentally exposed to water, remove the transmitter battery and allow the transmitter to air-dry completely. Replace with a fresh battery before resuming operation.

SAFETY TIPS – FOR ALL DRIVING ENVIRONMENTS

- NEVER drive your vehicle on streets! They're for real cars!
- DO NOT pick up vehicle while in motion.
- Keep fingers, hair and loose clothing away from the PowerScrews while the vehicle is switched ON.
- Adult supervision is recommended when this vehicle is being operated.
- To avoid accidental operation, remove all batteries when not in use. Always turn the vehicle OFF before removing batteries.

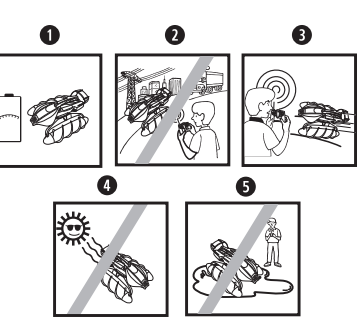

SPECIAL SAFETY INFORMATION – FOR WATER OPERATION

Do not operate near swimmers. Stand away from the water's edge when operating.

BATTERY SAFETY INFORMATION

- In exceptional circumstances batteries may leak fluids that can cause a chemical burn injury or ruin your product. To avoid battery leakage:
- Non-rechargeable batteries are not to be recharged.
 - Rechargeable batteries are to be removed from the product before being charged (if designed to be removable).
 - Rechargeable batteries are only to be charged under adult supervision (if designed to be removable).
 - Do not mix alkaline, standard (carbon-zinc), or rechargeable (nickel-cadmium) batteries.
 - Do not mix old and new batteries.
 - Only batteries of the same or equivalent type as recommended are to be used.
 - Batteries are to be inserted with the correct polarity.
 - Exhausted batteries are to be removed from the product.
 - The supply terminals are not to be short-circuited.
 - Dispose of battery(ies) safely.
 - Do not dispose of this product in a fire. The batteries inside may explode or leak.

Battery Performance Note:

For best performance use regular or high-performance alkaline batteries (where disposable batteries are called for). If your vehicle is supplied with standard (carbon-zinc) batteries for initial use and/or demonstration purposes, we recommend replacing them with alkaline batteries when necessary. Battery life may vary depending on battery brand.

This device complies with Part 15 of the FCC Rules.

Operation is subject to the following two conditions:

- (1) This device may not cause harmful interference, and
 - (2) this device must accept any interference received, including interference that may cause undesired operation.
- This equipment has been tested and found to comply with the limits for a Class B digital device, pursuant to part 15 of the FCC rules. These limits are designed to provide reasonable protection against harmful interference in a residential installation. This equipment generates, uses and can radiate radio frequency energy and, if not installed and used in accordance with the instructions, may cause harmful interference to radio communications. However, there is no guarantee that interference will not occur in a particular installation. If this equipment does cause harmful interference to radio or television reception, which can be determined by turning the equipment off and on, the user is encouraged to try to correct the interference by one or more of the following measures:
- Reorient or relocate the receiving antenna.
 - Increase the separation between the equipment and receiver.
 - Connect the equipment into an outlet on a circuit different from that to which the receiver is connected.
 - Consult the dealer or an experienced radio/TV technician for help.

NOTE: Changes or modifications not expressly approved by the manufacturer responsible for compliance could void the user's authority to operate the equipment.