



**INSTRUCTIONS • MODE D'EMPLOI • ANLEITUNG
ISTRUZIONI • GEBRUIKSAANWIJZING • INSTRUCCIONES
INSTRUÇÕES • ANVISNINGAR • OHJEET • ΟΔΗΓΙΕΣ**



- Contains small parts.
- Petits éléments détachables susceptibles d'être avalés.
- Enthält Kleinteile.
- Contiene pezzi di piccole dimensioni che possono essere aspirati o ingeriti.
- Bevat kleine onderdelen.
- Contiene piezas pequeñas que pueden ser ingeridas y provocar asfixia.
- **ATENÇÃO:** Não recomendável para menores de 3 anos por conter partes pequenas que podem ser engolidas.
- Innehåller små delar.
- Smådelar.
- Sisältää pieniä osia.
- Περιέχει μικρά εξαρτήματα.

- Please keep these instructions for future reference as they contain important information.
- Conserver ce mode d'emploi pour s'y référer au besoin car il contient des informations importantes.
- Diese Anleitung bitte für mögliche Rückfragen aufbewahren. Sie enthält wichtige Informationen.
- Conservare queste istruzioni per futuro riferimento. Contengono importanti informazioni.
- Bewaar deze gebruiksaanwijzing. Kan later nog van pas komen.
- Sirvanse guardar estas instrucciones para futura referencia, ya que contienen información de importancia acerca de este juguete.
- Guardar estas instruções para referência futura, pois contém informação importante.
- Spara de här anvisningarna för framtiden, de innehåller viktig information.
- Säilytä nämä ohjeet vastaisen varalle. Niissä on tärkeää tietoa.
- Παρακαλώ κρατήστε αυτές τις οδηγίες για μελλοντική χρήση καθώς περιέχουν σημαντικές πληροφορίες.



WARNING:
CHOKING HAZARD - Small parts.
Not for children under 3 years.

ADVERTENCIA:
PUEDA CAUSAR ASFIXIA.
No recomendable para menores de 3 años. Contiene piezas pequeñas.

ATTENTION:
NE CONVIENT PAS aux enfants de moins de 36 mois. Petits éléments détachables susceptibles d'être avalés.

CONTENTS • CONTIENT • INHALT • CONTENUTO • INHOUD • CONTENIDO • CONTEÚDO • INNEHÅLL • SISÄLTÖ • ΠΕΡΙΕΧΟΜΕΝΑ

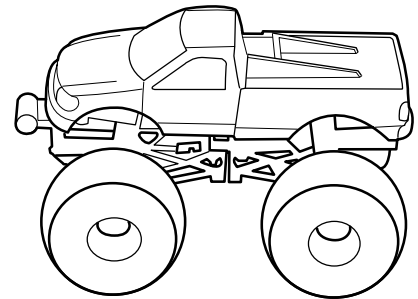
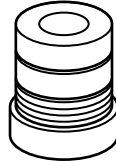
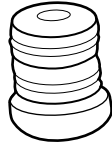
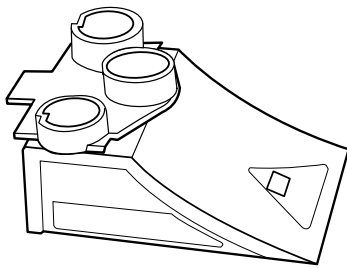

**ASSEMBLY • ASSEMBLAGE • ZUSAMMENBAU • MONTAGGIO • HET IN ELKAAR ZETTEN • MONTAJE • MONTAGEM
MONTERING • KOKOAMINEN • ΣΥΝΑΡΜΟΛΟΓΗΣΗ**

1

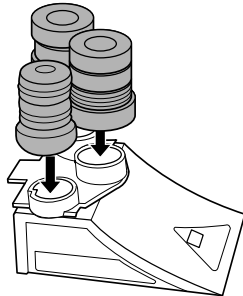

2

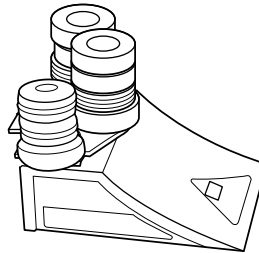

**TO PLAY • POUR JOUER • SPIELN • GIOCHIAMO • ZO SPEEL JE • ¡A JUGAR! • PARA BRINCAR
SÅ HÄR ANVÄNDS LEKSAKEN • KUINKA TÄLLÄ LEIKITÄÄN • ΠΩΣ ΝΑ ΠΑΙΞΕΤΕ**

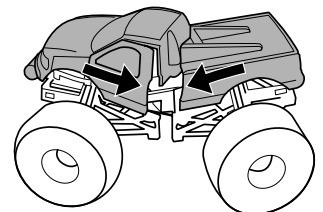
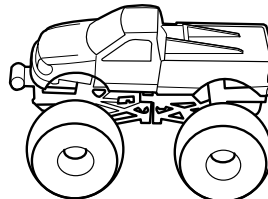
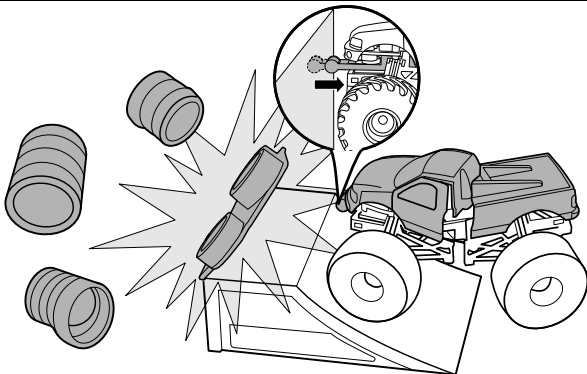

Reset • Réenclencher
Hineinschieben • Resettare
Resetten • Restablecer
Reiniciar • Återställa
Κάynnιστή • Επαναφορά

© 2004 Mattel, Inc. All Rights Reserved. Tous droits réservés. Mattel Canada Inc., Mississauga, Ontario L5R 3W2. You may call us free at 1-800-665-6288. Mattel U.K. Ltd., Vanwall Business Park, Maidenhead SL6 4UB. Helpline 01628500303. Mattel France, 27/33 rue d'Antony, Sillat 145, 94523 Rungis Cedex N° Indigo 0 825 00 00 25 (0.15 € TTC/mn) ou www.allmattel.com. Mattel B.V., Postbus 576, 1180 AN Amstelveen, Nederland. 0800 - 2628835. Mattel Belgium, Trade Mart, Atomiumsquare, Bogota 202 - B 275, 1020 Brussels. Deutschland: Mattel GmbH, An der Trift 75 D-63303 Dreieich, Schweiz: Mattel AG, Monbijoustrasse 68, CH-3000 Bern 23. Österreich: Mattel Ges.m.b.H., Triester Str., A-2355 Wiener Neudorf. Mattel Scandinavia A/S, Ringager 4C, DK-2605 Brøndby. Mattel Northern Europe A/S, Sinikalliontie 3, 02630 ESPOO, Puh. 0303 9060. Mattel Srl, 28040 Oleggio Castello, Italy. Mattel España, S.A., Aribau 200, 08036 Barcelona. cservice.spain@mattel.com Mattel Portugal Lda., Av. da República, nº 90/96, 2º andar Fração 2, 1600-206 Lisboa Mattel AEBE, EilēOēIO± 2, αllēOēlll 16777. 08§§©©. Mattel Australia Pty., Ltd., Richmond, Victoria, 3121. Consumer Advisory Service - 1300 135 312. Mattel East Asia Ltd., Room 1106, South Tower, World Finance Centre, Harbour City, Tsinghsatui, HK, China. Diimport & Diedarkan Oleh: Mattel SEA Ptd Ltd.(993532-P) Lot 13.5, 13th Floor, Menara Lien Hoe, Persiaran Tropicana Golf Country Resort, 47410 PJ. Tel:03-78803817, Fax:03-78803867. Mattel, Inc., 333 Continental Blvd., El Segundo, CA 90245 U.S.A. Consumer Affairs 1 (800) 524-Toys. Importado y distribuido por Mattel de México, S.A. de C.V., Insurgentes Sur # 3579, Torre 3, Oficina 601, Col. Tlalpan, Delegación Tlalpan, C.P. 14020, México, D.F. TEL: 54-49-41-00. R.F.C. MME-920701-NB3. Mattel Chile, S.A., Avenida Américo Vespucio 501-B, Quilicura, Santiago. Mattel de Venezuela, C.A., Ave. Mara, C.C. Macaracuay Plaza, Torre B, Piso 8, Colinas de la California, Caracas 1071. Mattel Argentina S.A., Curupaytí 1186, (1607) - Villa Adelina, Buenos Aires. Mattel Colombia, S.A., calle 123#7-07 P.5, Bogotá. Mattel do Brasil Ltda. - CNPJ : 54.558.002/0004-72 Av. Tamboré, 1400/1440 Quadra A de 02 a 03 - 06460-000 - Barueri - SP. Atendimento ao Consumidor: SAC 0800550780.

B4019-0520
B4019-8562-S1
B4019-9862-S1





**INSTRUCTIONS • MODE D'EMPLOI • ANLEITUNG
ISTRUZIONI • GEBRUIKSAANWIJZING • INSTRUCCIONES
INSTRUÇÕES • ANVISNINGAR • OHJEET • ΟΔΗΓΙΕΣ**



- Contains small parts.
- Petits éléments détachables susceptibles d'être avalés.
- Enthält Kleinteile.
- Contiene pezzi di piccole dimensioni che possono essere aspirati o ingeriti.
- Bevat kleine onderdelen.
- Contiene piezas pequeñas que pueden ser ingeridas y provocar asfixia.
- ATENÇÃO: Não recomendável para menores de 3 anos por conter partes pequenas que podem ser engolidas.
- Innehåller små delar.
- Smådelar.
- Sisältää pieniä osia.
- Περιέχει μικρά εξαρτήματα.

- Please keep these instructions for future reference as they contain important information.
- Conserver ce mode d'emploi pour s'y référer au besoin car il contient des informations importantes.
- Diese Anleitung bitte für mögliche Rückfragen aufbewahren. Sie enthält wichtige Informationen.
- Conservare queste istruzioni per futuro riferimento. Contengono importanti informazioni.
- Bewaar deze gebruiksaanwijzing. Kan later nog van pas komen.
- Sirvanse guardar estas instrucciones para futura referencia, ya que contienen información de importancia acerca de este juguete.
- Guardar estas instruções para referência futura, pois contém informação importante.
- Spara de här anvisningarna för framtiden, de innehåller viktig information.
- Säilytä nämä ohjeet vastaisen varalle. Niissä on tärkeää tietoa.
- Παρακαλώ κρατήστε αυτές τις οδηγίες για μελλοντική χρήση καθώς περιέχουν σημαντικές πληροφορίες.



WARNING:
CHOKING HAZARD - Small parts.
Not for children under 3 years.

ADVERTENCIA:
PUEDO CAUSAR ASFIXIA.
No recomendable para menores de 3 años. Contiene piezas pequeñas.

ATTENTION:
NE CONVIENT PAS aux enfants de moins de 36 mois. Petits éléments détachables susceptibles d'être avalés.

CONTENTS • CONTIENT • INHALT • CONTENUTO • INHOUD • CONTENIDO • CONTEÚDO • INNEHÅLL • SISÄLTÖ • ΠΕΡΙΕΧΟΜΕΝΑ

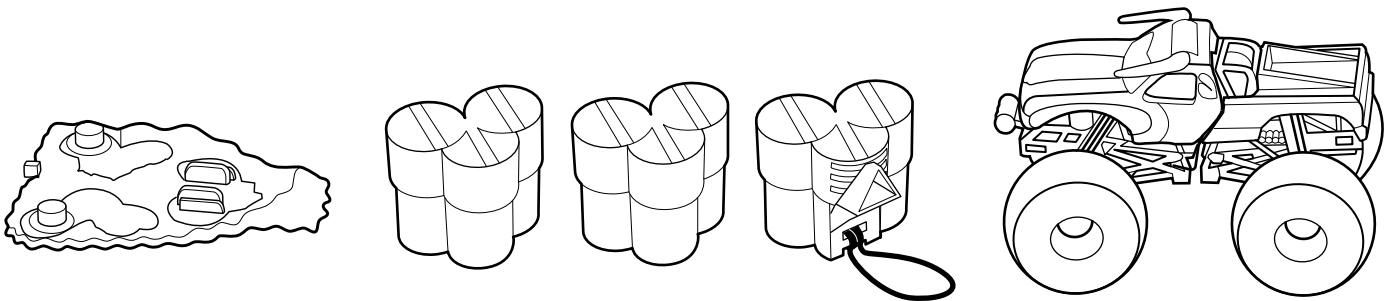

**ASSEMBLY • ASSEMBLAGE • ZUSAMMENBAU • MONTAGGIO • HET IN ELKAAR ZETTEN • MONTAJE • MONTAGEM
MONTERING • KOKOAMINEN • ΣΥΝΑΡΜΟΛΟΓΗΣΗ**

1

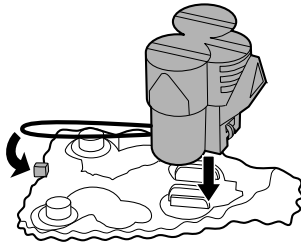

2

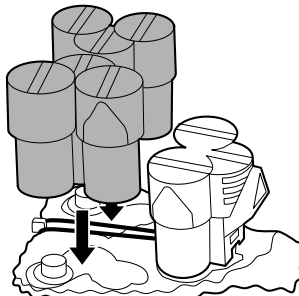

3

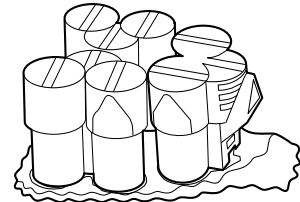

**TO PLAY • POUR JOUER • SPIELEN • GIOCHIAMO • ZO SPEEL JE • ¡A JUGAR! • PARA BRINCAR
SÅ HÄR ANVÄNDS LEKSÅKEN • KUINKA TÄLLÄ LEIKITÄÄN • ΠΩΣ ΝΑ ΠΑΙΞΕΤΕ**

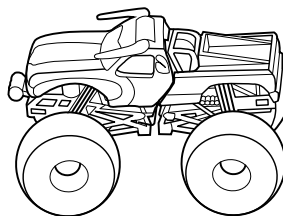
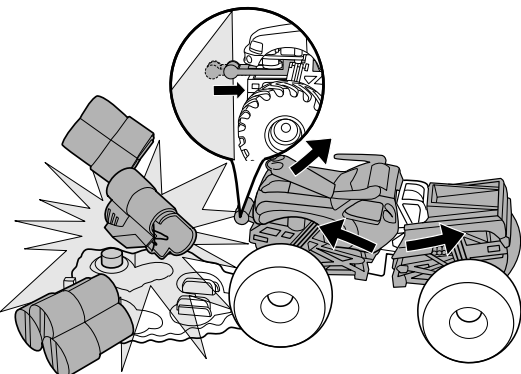

Reset • Réenclencher
Hineinschieben • Resettare
Resetten • Restablecer
Reiniciar • Återställa
Καynnιστή • Επαναφορά

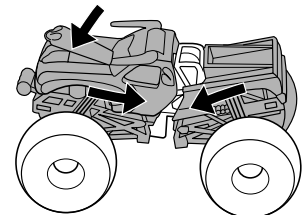

© 2004 Mattel, Inc. All Rights Reserved. Tous droits réservés. Mattel Canada Inc., Mississauga, Ontario L5R 3W2. You may call us free at 1-800-665-6288. Mattel U.K. Ltd., Vanwall Business Park, Maidenhead SL6 4UB. Helpline 01628500303. Mattel France, 2733 rue d'Antony, S.I.C. 145, 94523 Rungis Cedex N° Indigo 0 825 00 00 25 (0,15 € TTC/mn) ou www.allomattel.com. Mattel B.V., Postbus 576, 1180 AN Amstelveen, Nederland. 0800 - 2628835. Mattel Belgium, Trade Mart, Atomiumsquare, Bogota 202 - B 275, 1020 Brussels. Deutschland: Mattel GmbH, An der Trift 75 D-63303 Dreieich. Schweiz: Mattel AG, Monbijoustrasse 68, CH-3000 Bern 23, Österreich: Mattel Ges.m.b.H., Triester Str., A-2355 Wiener Neudorf. Mattel Scandinavia A/S, Ringager 4C, DK-2605 Brøndby. Mattel Northern Europe A/S, Sinikallontie 3, 02630 ESPOO, Puh. 0303 9060. Mattel Srl, 28040 Oleggio Castello, Italy. Mattel España, S.A., Arriba 200, 08036 Barcelona. cservice.spain@mattel.com Mattel Portugal Lda., Av. da República, n° 90/96, 2° andar Fracção 2, 1600-206 Lisboa Mattel AEBE, ΕΠΙΘΕΩΡΗΣΗ 2, ΑΙΘΡΟΣ 16777, Αθήνα. Mattel Australia Pty., Ltd., Richmond, Victoria, 3121. Consumer Advisory Service - 1300 135 312. Mattel East Asia Ltd., Room 1106, South Tower, World Finance Centre, Harbour City, Tsimshatsui, HK, China. Diimport & Diedarkan Oleh: Mattel SEA Ptd Ltd.(993532-P) Lot 13.5, 13th Floor, Menara Lien Hoe, Persiaran Tropicana Golf Country Resort, 47410 PJ. Tel:03-78803817, Fax:03-78803867. Mattel, Inc., 333 Continental Blvd., El Segundo, CA 90245 U.S.A. Consumer Affairs 1 (800) 524-Toys. Importado y distribuido por Mattel de México, S.A. de C.V., Insurgentes Sur # 3579, Torre 3, Oficina 601, Col. Tlalpan, Delegación Tlalpan, C.P. 14020, México, D.F. TEL: 54-49-41-00, R.F.C. MME-920701-NE3. Mattel Chile, S.A., Avenida Américo Vespucio 501-B, Quilicura, Santiago. Mattel de Venezuela, C.A., Ave. Mara, C.C. Macaracuy Plaza, Torre B, Piso 8, Colinas de la California, Caracas 1071. Mattel Argentina S.A., Curupayti 1186, (1607) - Villa Adelina, Buenos Aires. Mattel Colombia, S.A., calle 123#7-07 P.5, Bogotá. Mattel do Brasil Ltda. - CNPJ : 54.558.002/0004-72 Av. Tamboré, 1400/1440 Quadra A de 02 a 03 - 06460-000 - Barueri - SP. Atendimento ao Consumidor: SAC 0800550780.

B4020-0520
B4020-8562-S1
B4020-9862-S1

